

ตอนที่ 1

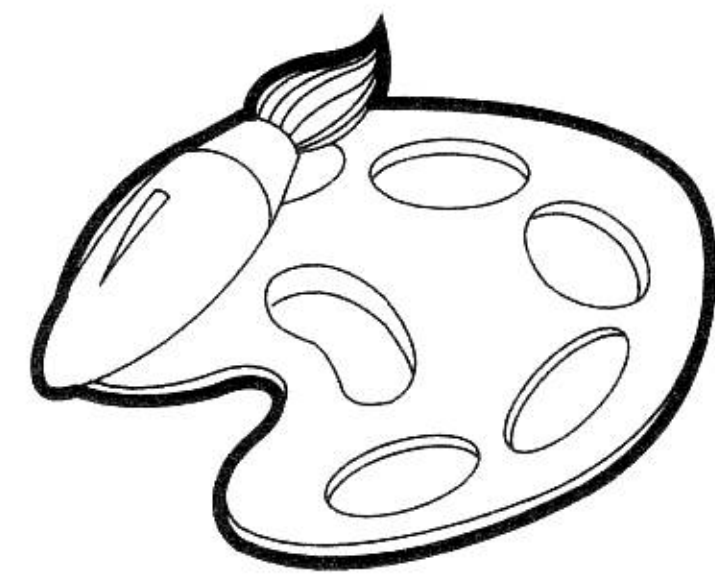

การจำแนกความเหมือนความต่าง

- ◇ การหาภาพที่เหมือนกับภาพที่กำหนด 20 ข้อ
- ◇ การหาเงาของภาพ 20 ข้อ
- ◇ การหาภาพที่เป็นพวกเดียวกัน 20 ข้อ
- ◇ การหาภาพที่มีคุณสมบัติเหมือนกัน 20 ข้อ
- ◇ การหาภาพที่แตกต่างกัน 20 ข้อ
- ◇ การหาภาพที่มีคุณสมบัติต่างกัน 20 ข้อ



จงขีด ✓ ภาพที่เหมือนกับภาพที่กำหนดให้ในช่องแรก

1

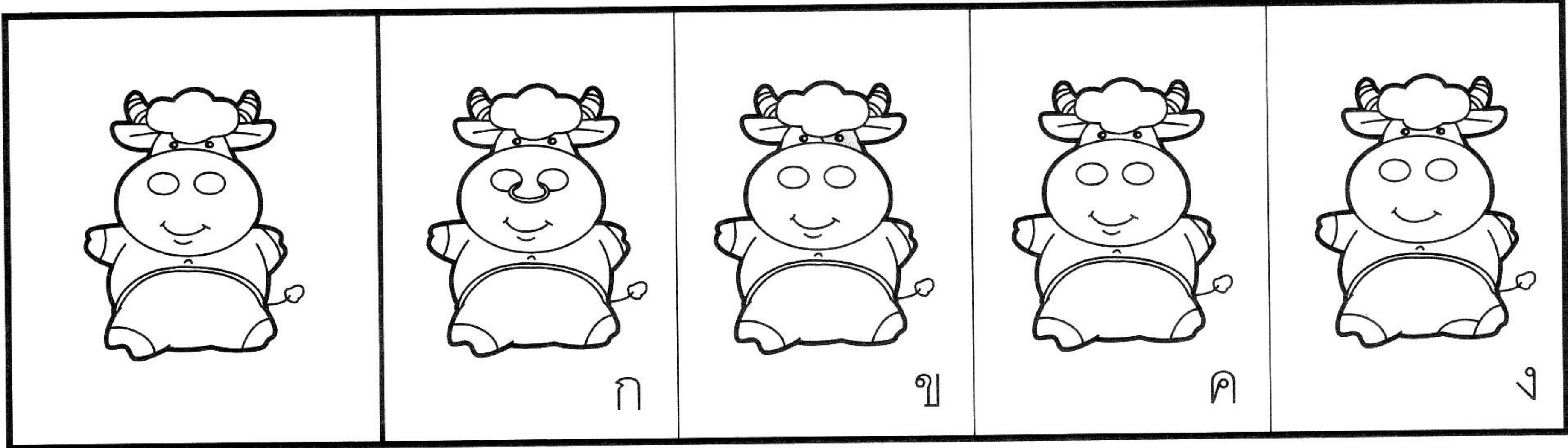

2

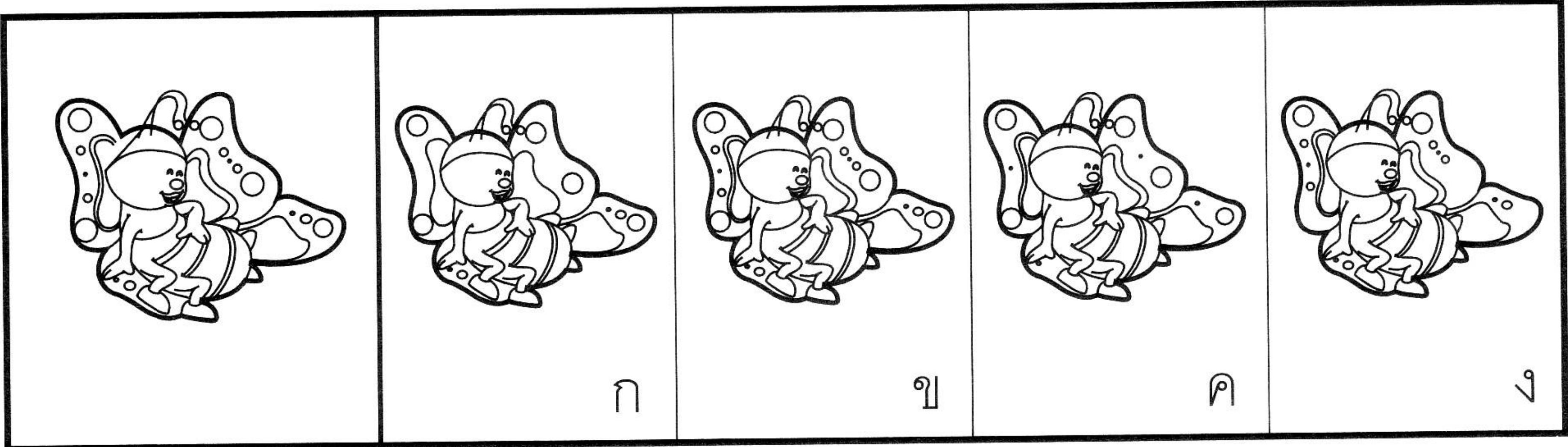

3

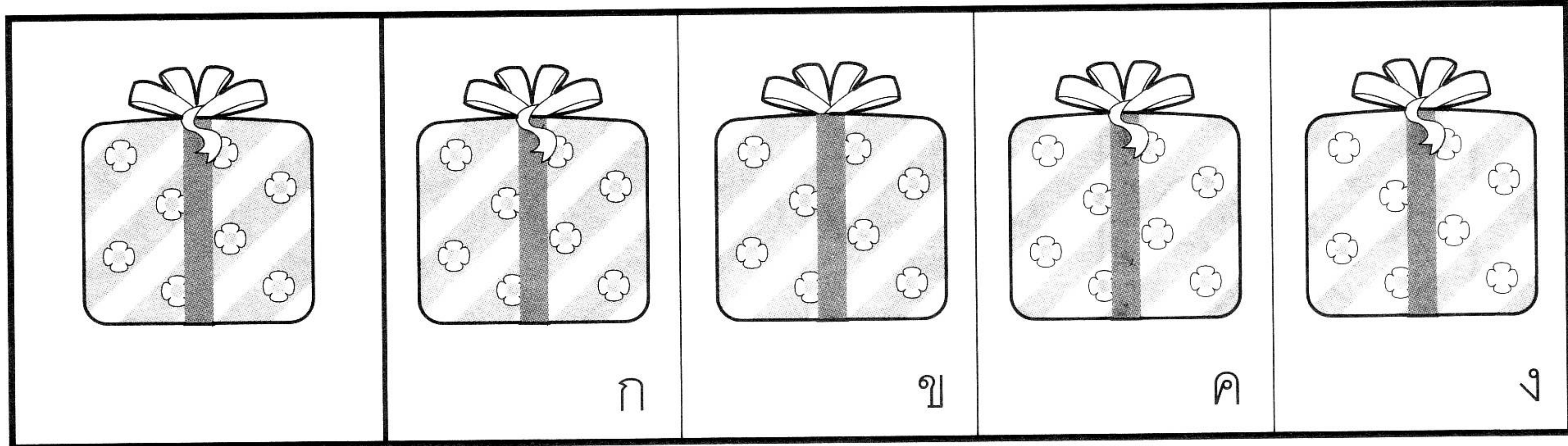

4

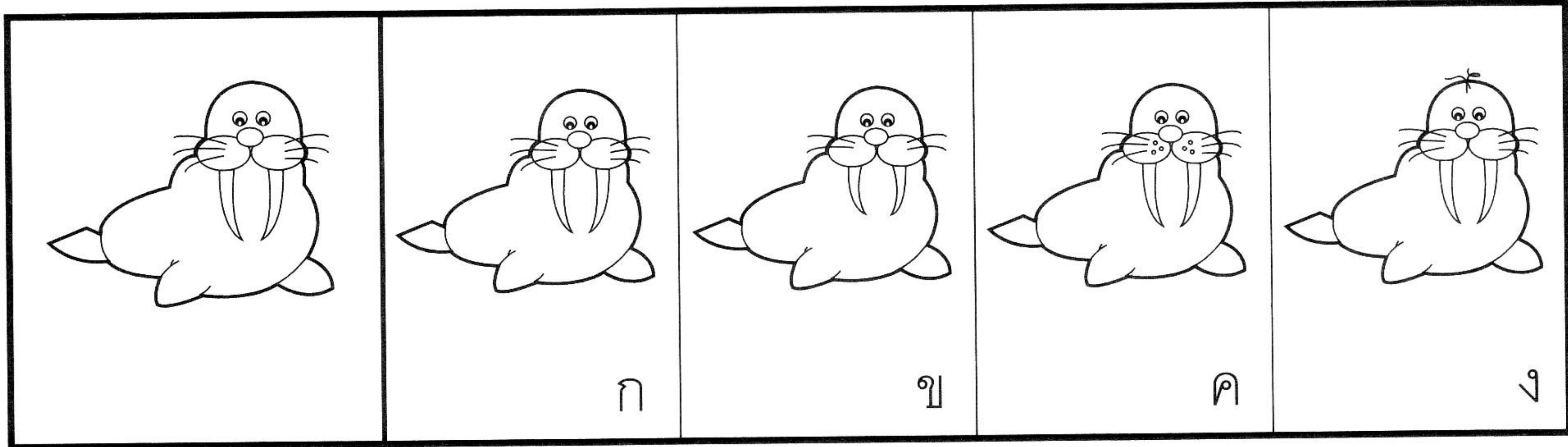

5

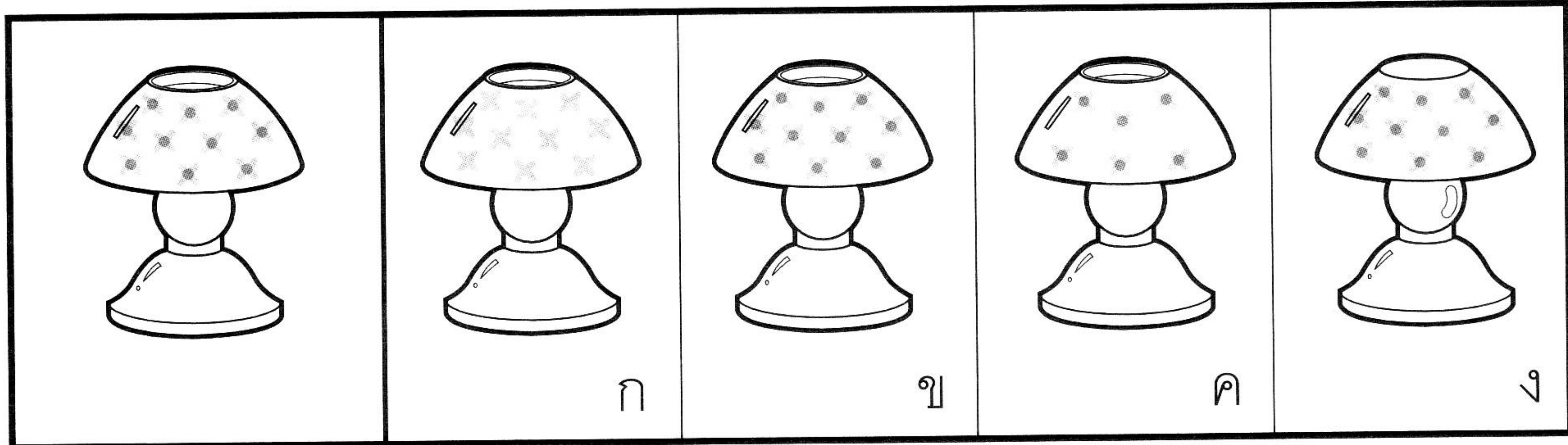

6

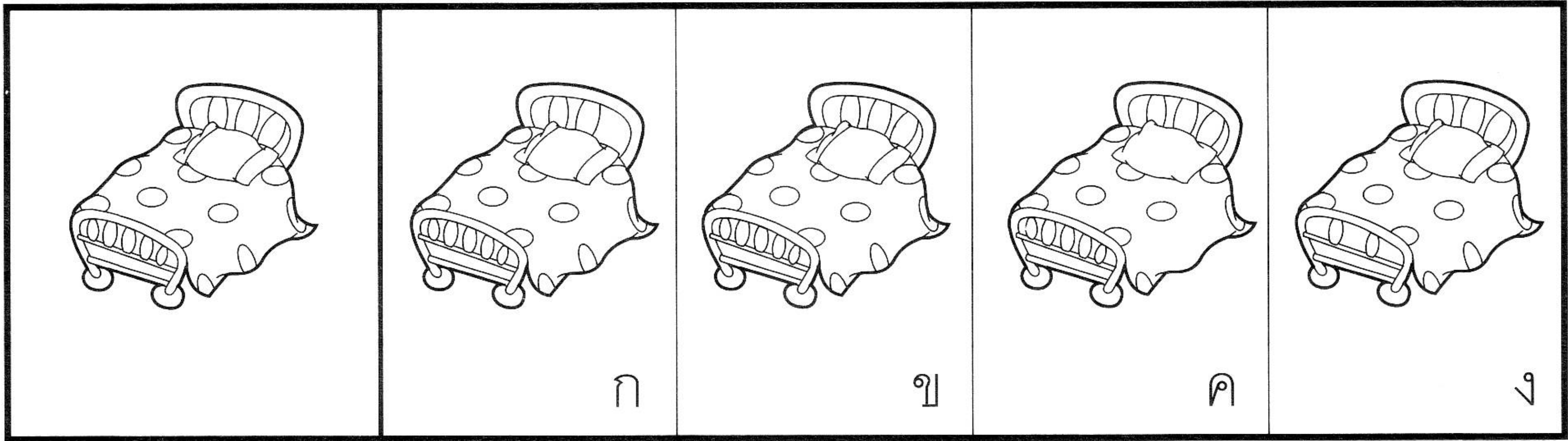

7

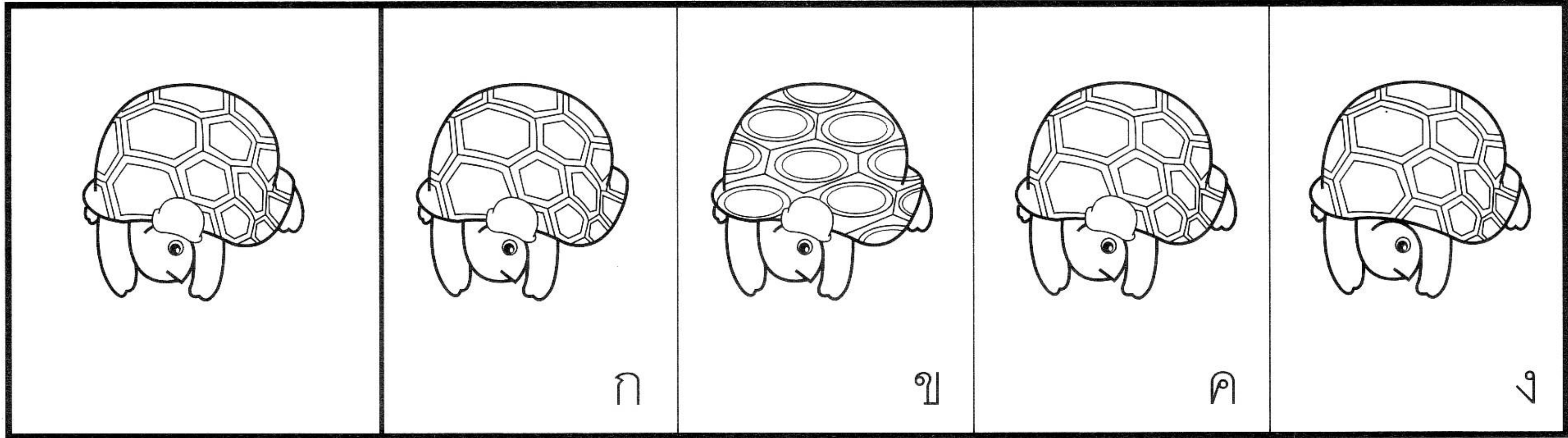

8

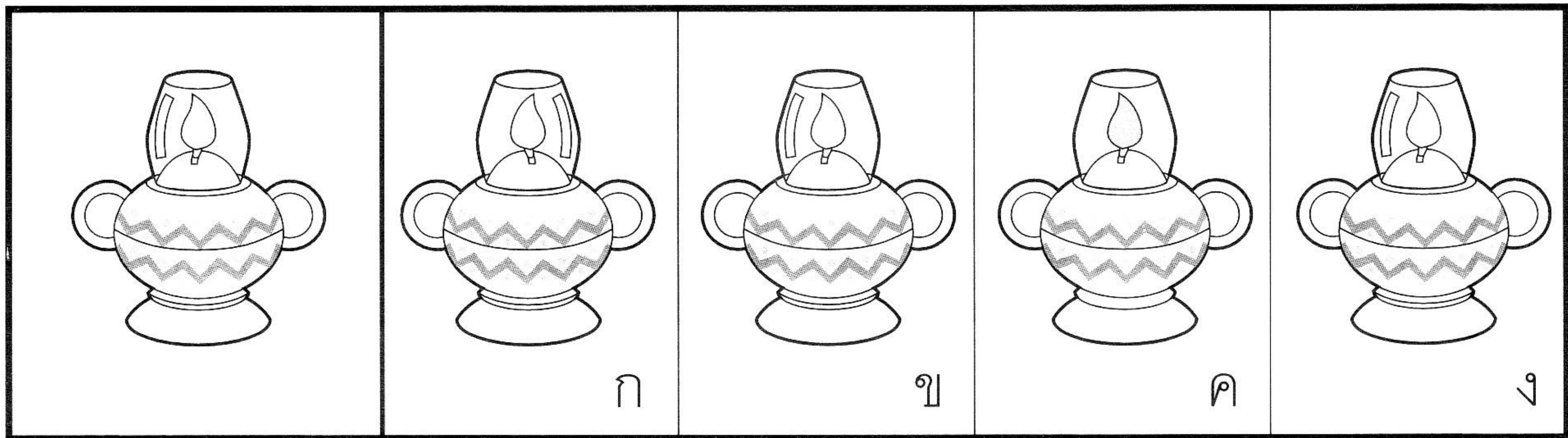

9

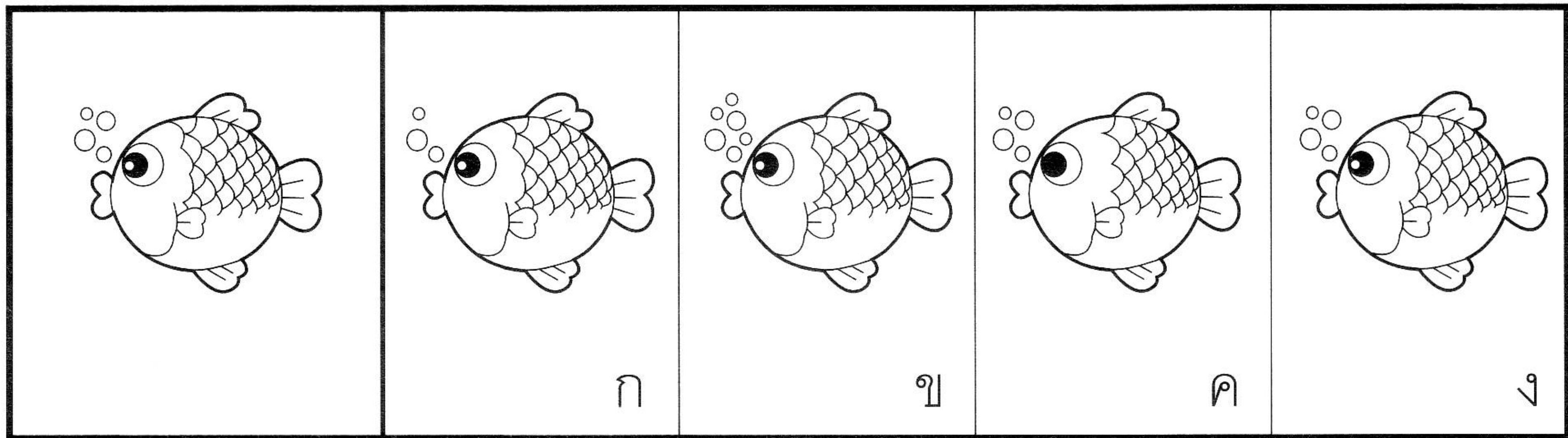

10

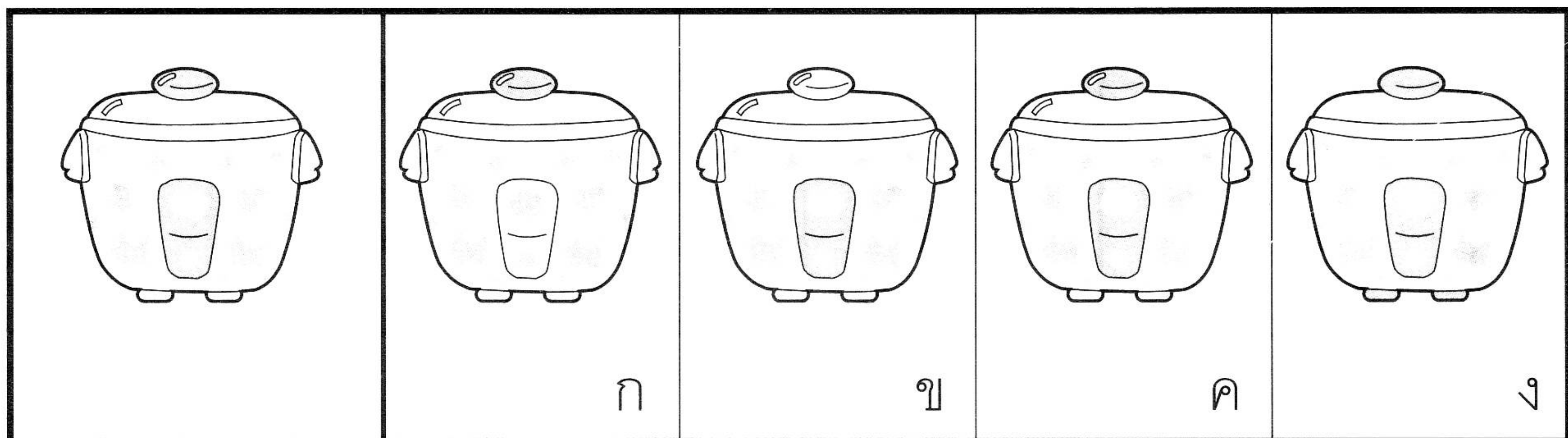

11

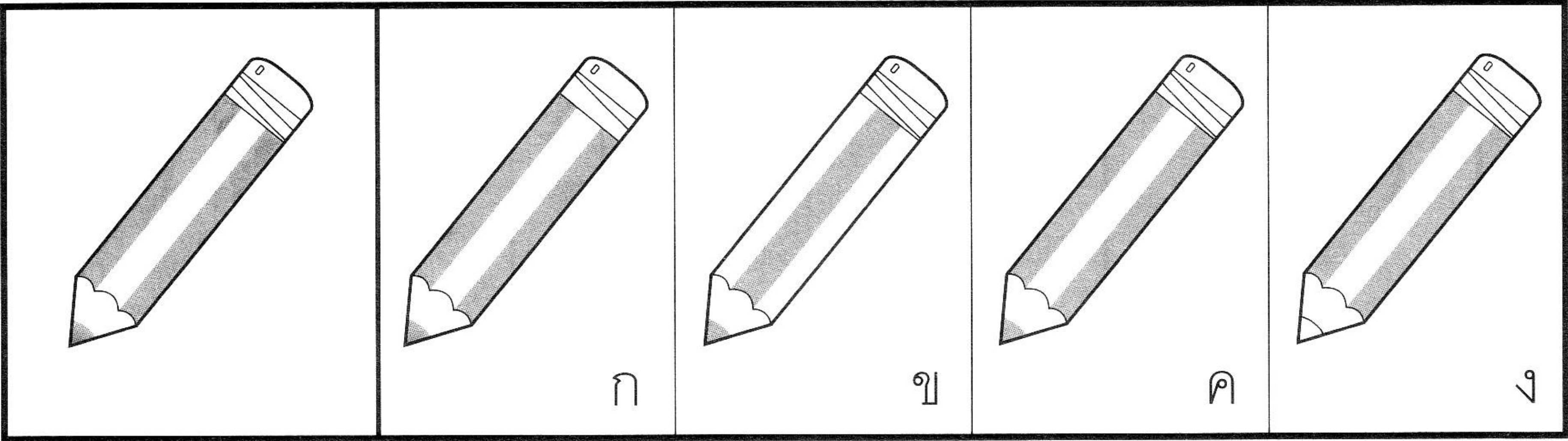

12

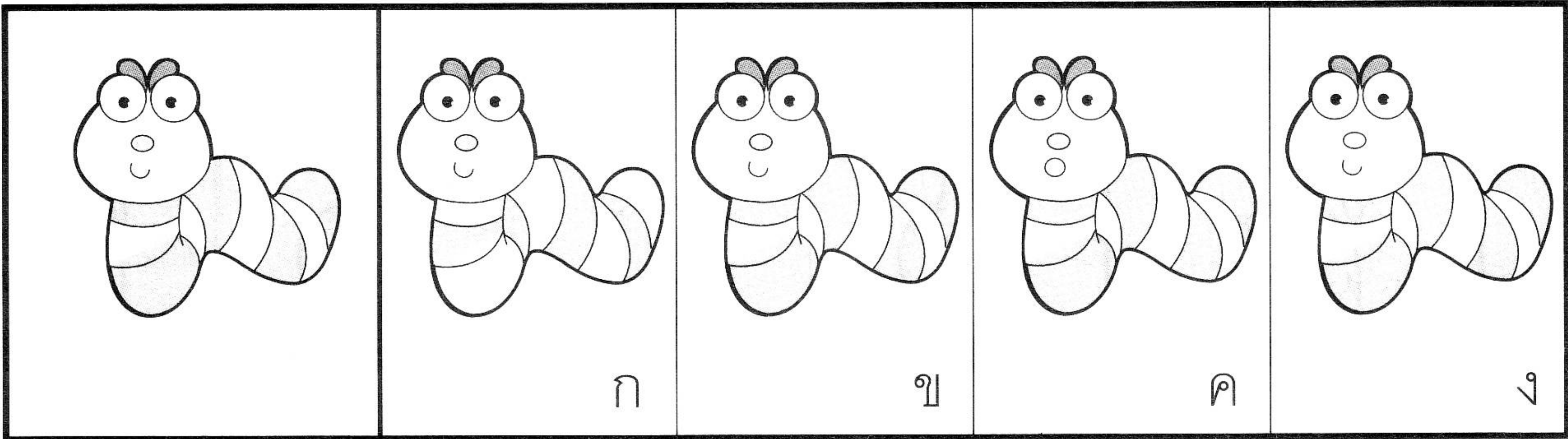

13

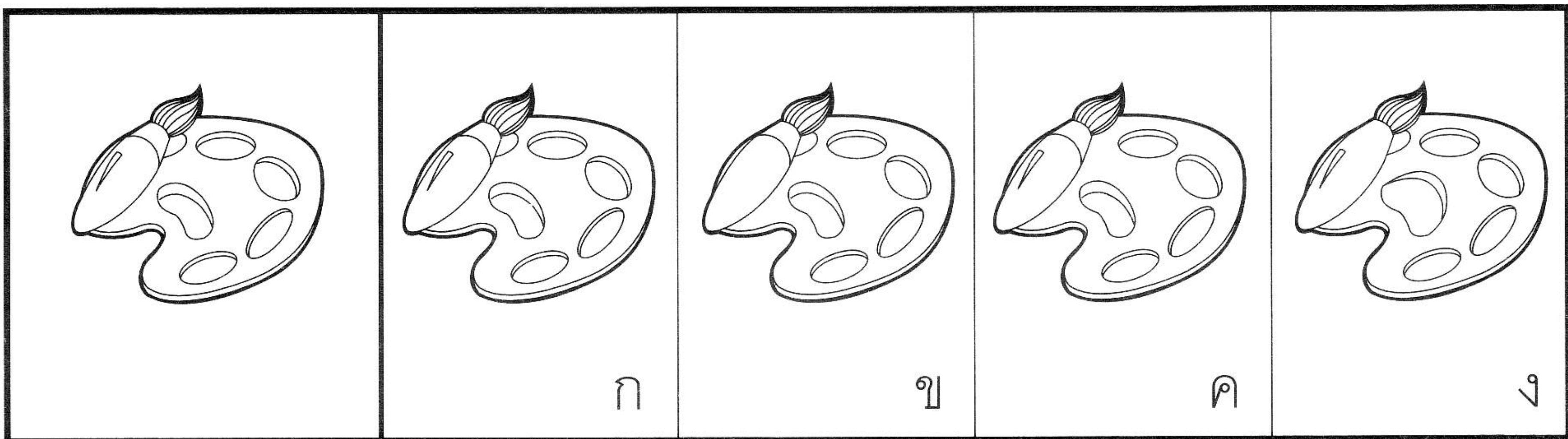

14

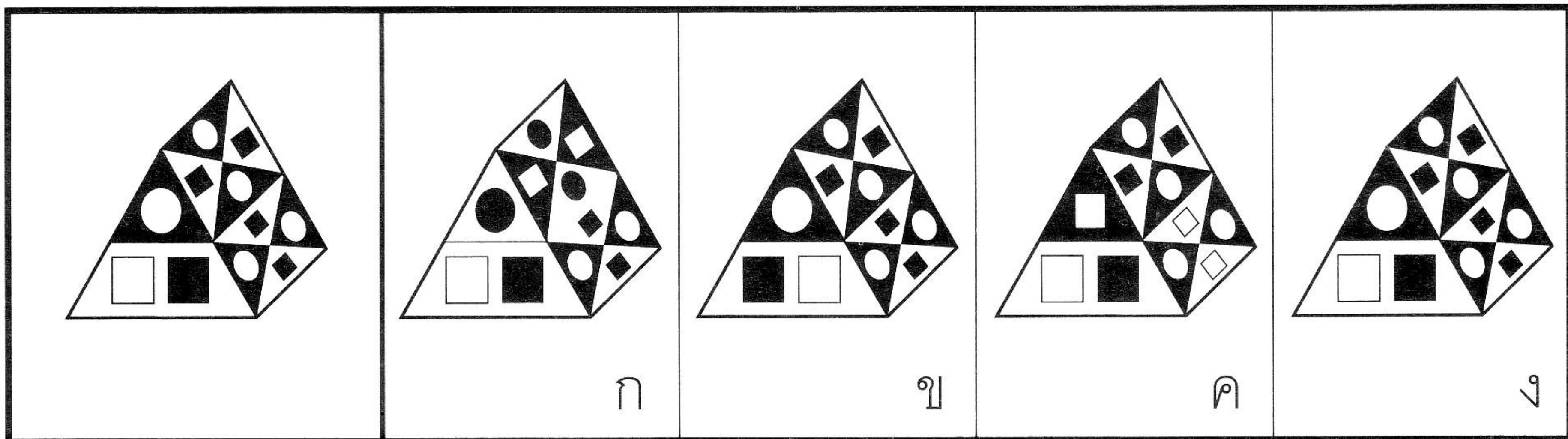

15

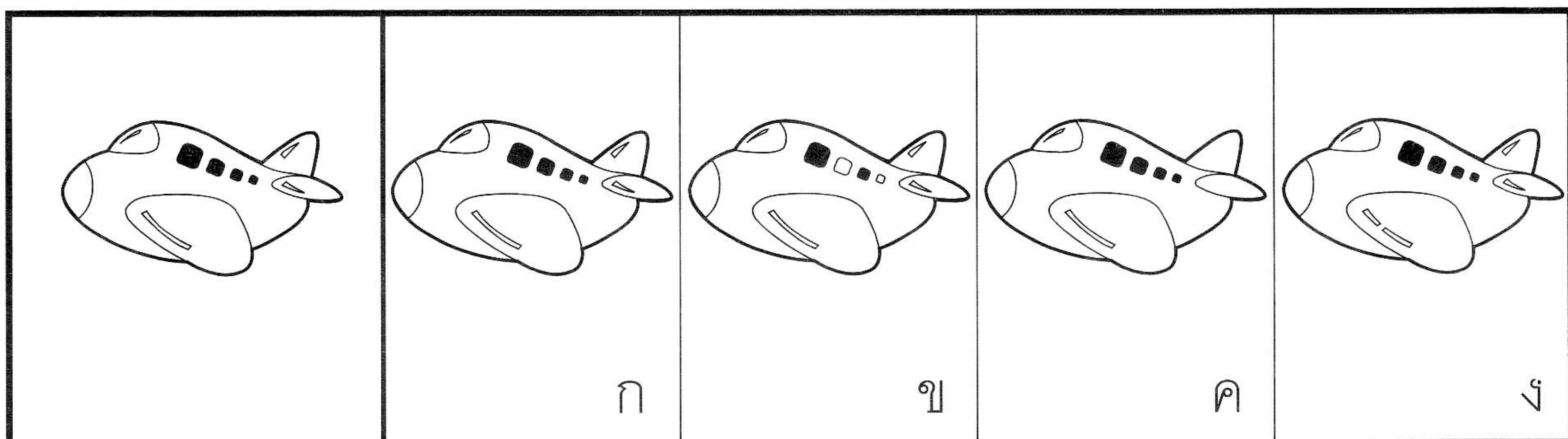

16

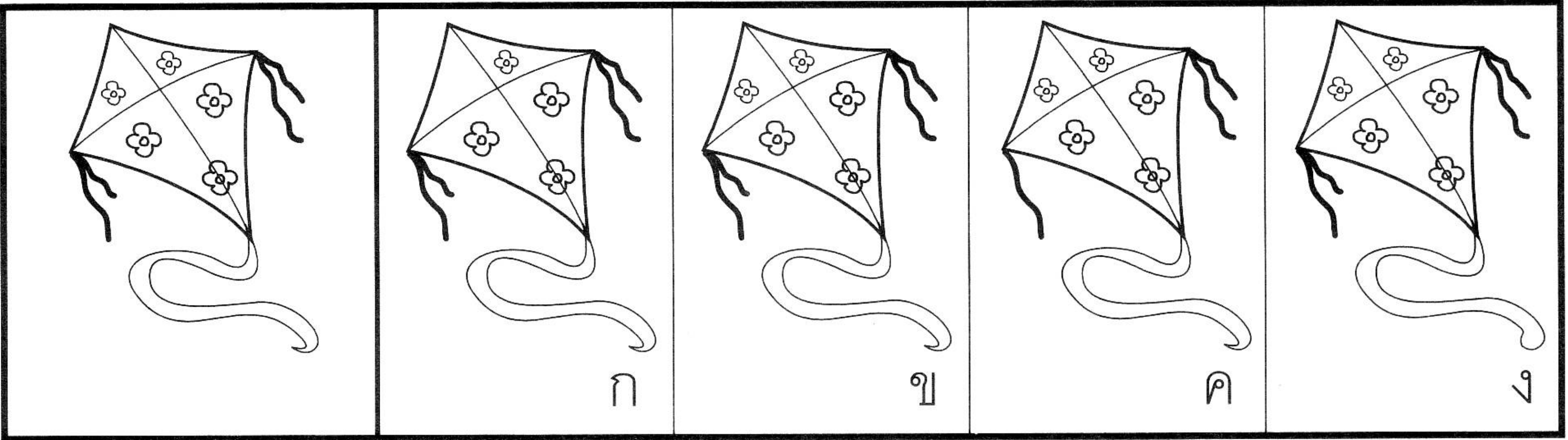

17

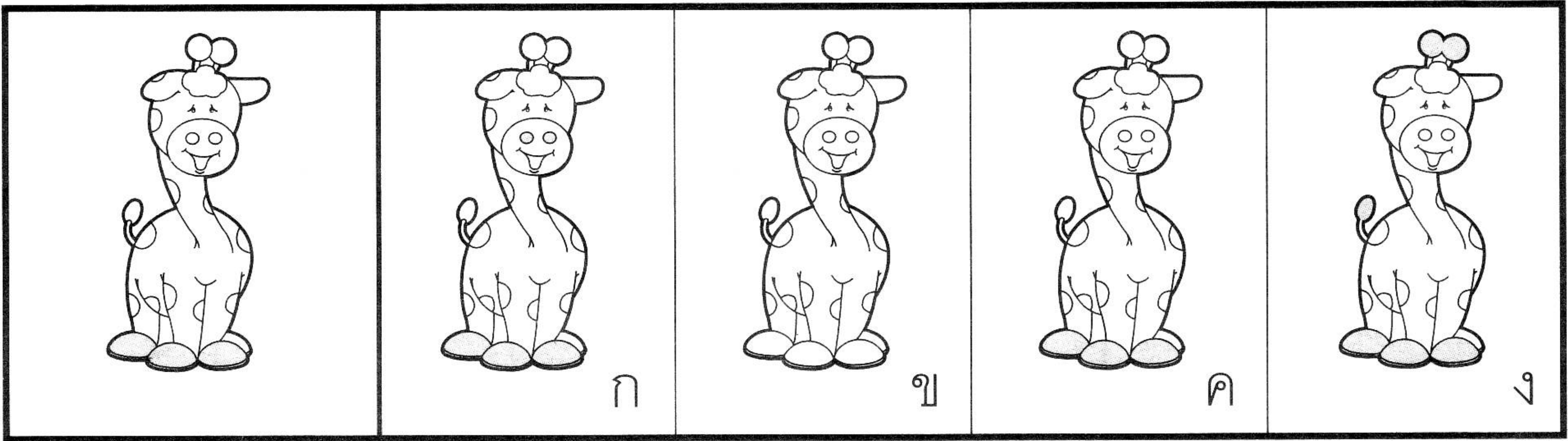

18

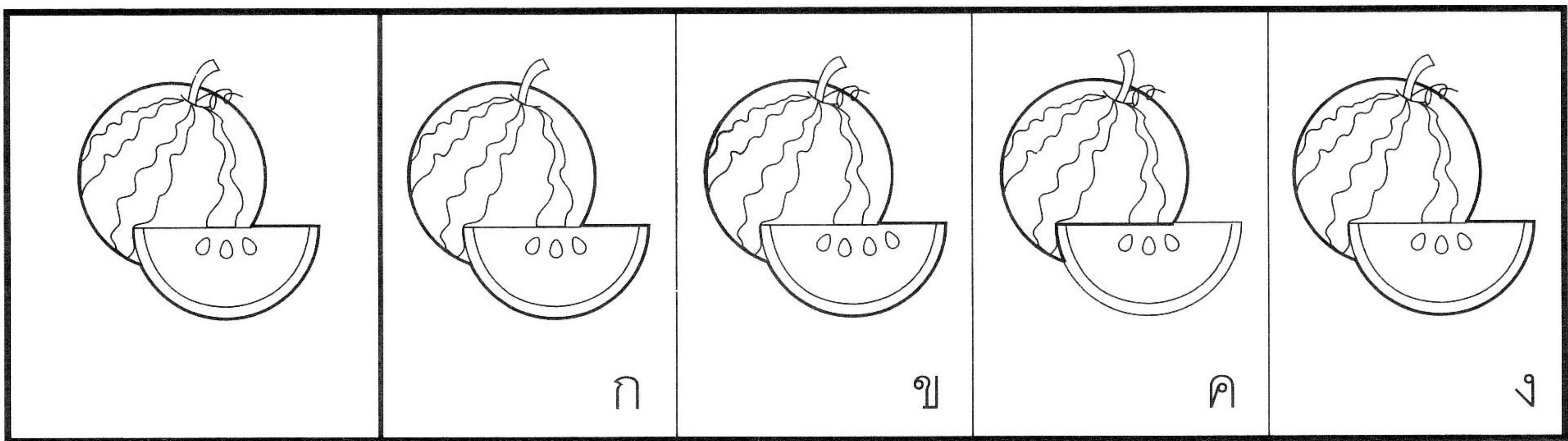

19

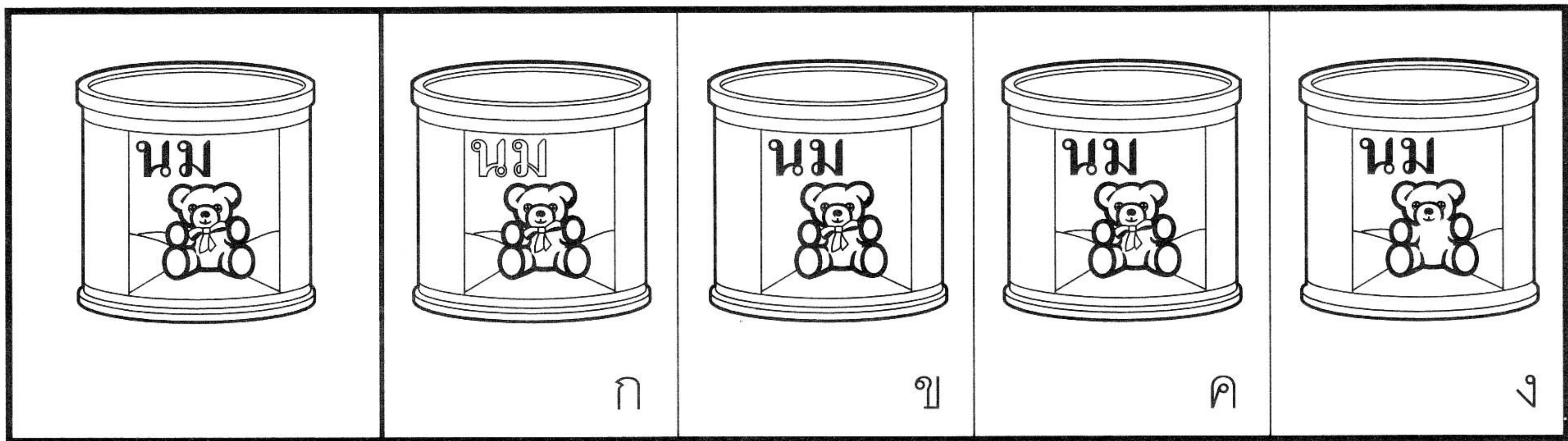



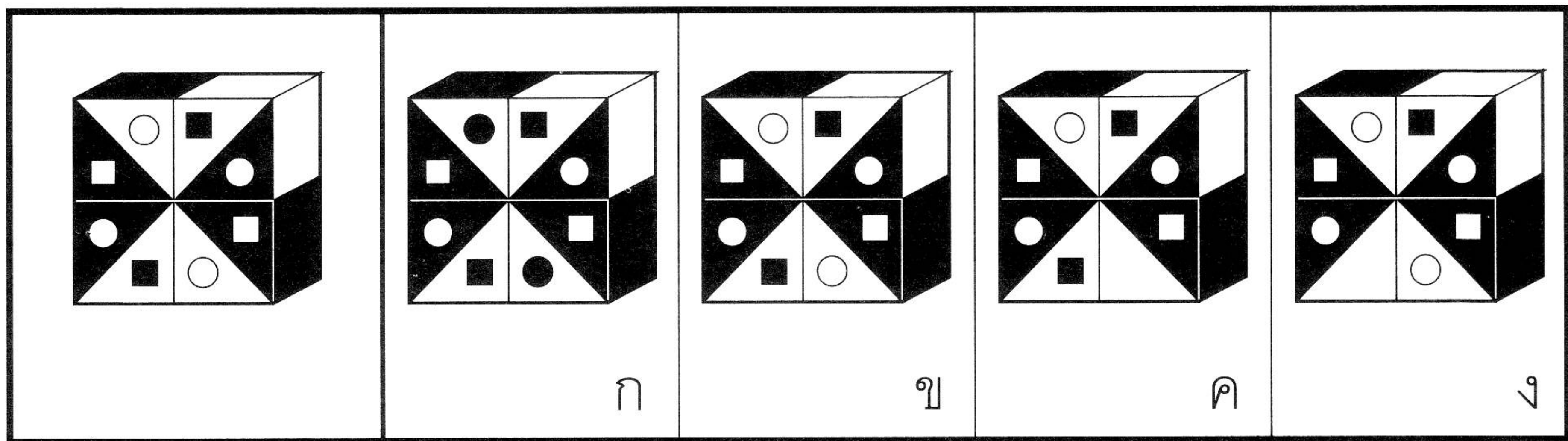

20



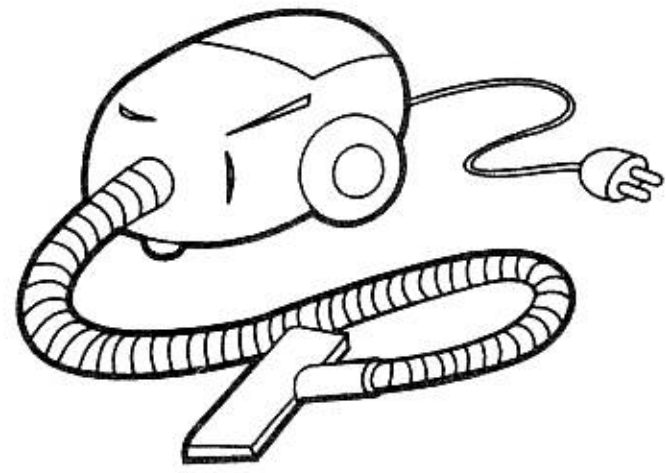



จงขีด X เงามที่ถูกต้องของภาพในช่องแรก

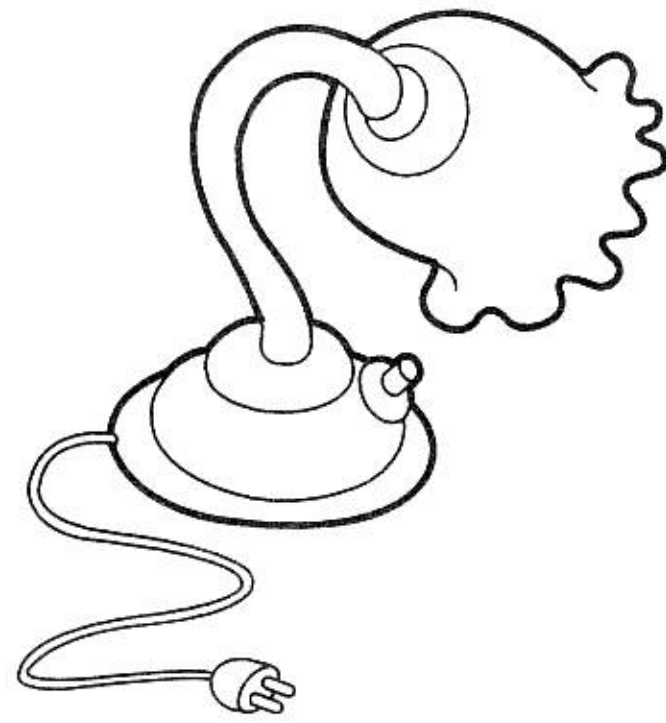

1

				
	ก	ข	ค	ง



2

				
	ก	ข	ค	ง

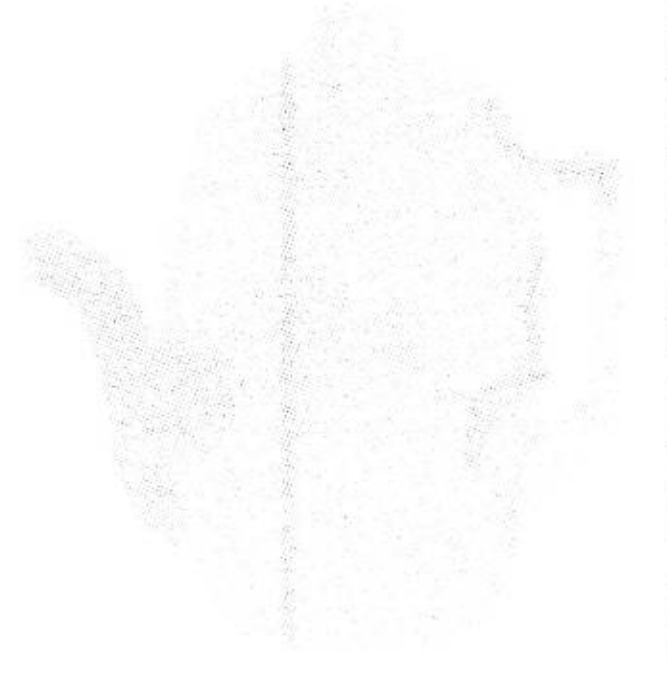
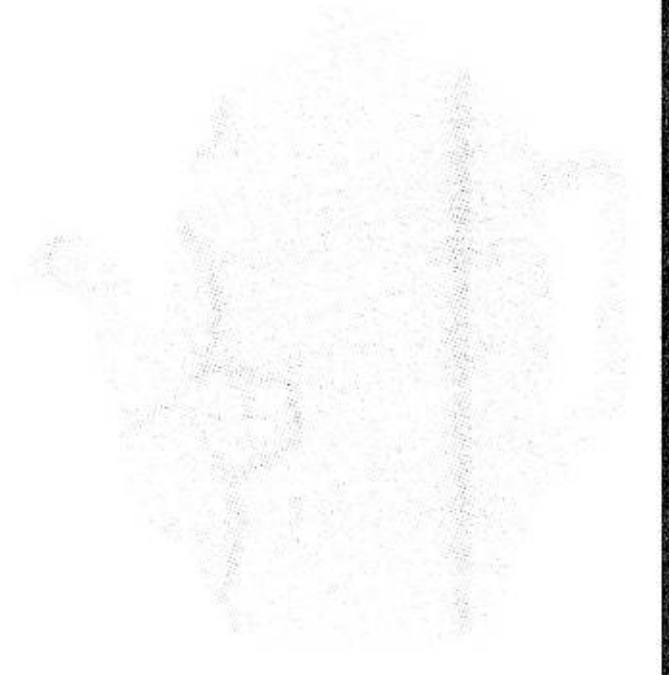

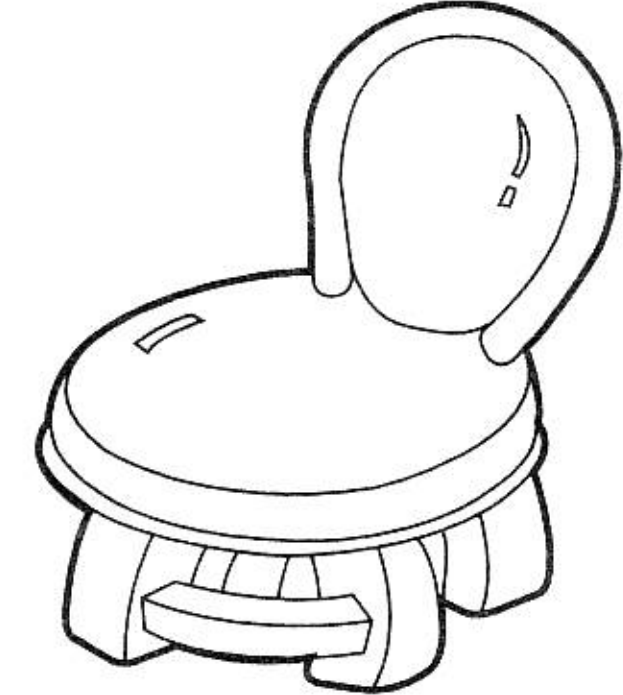
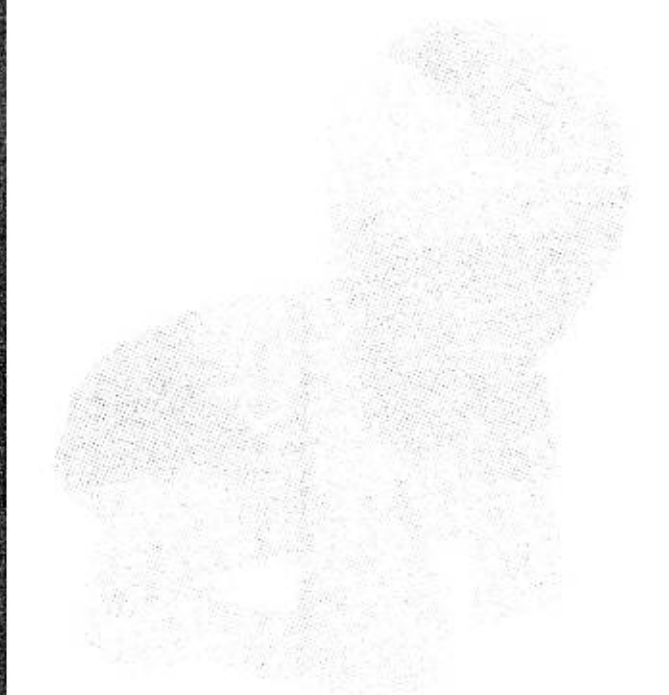
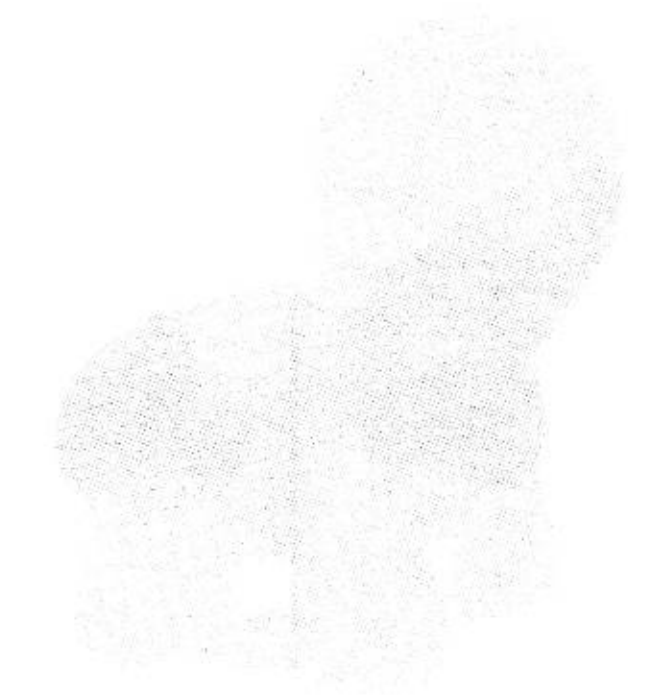
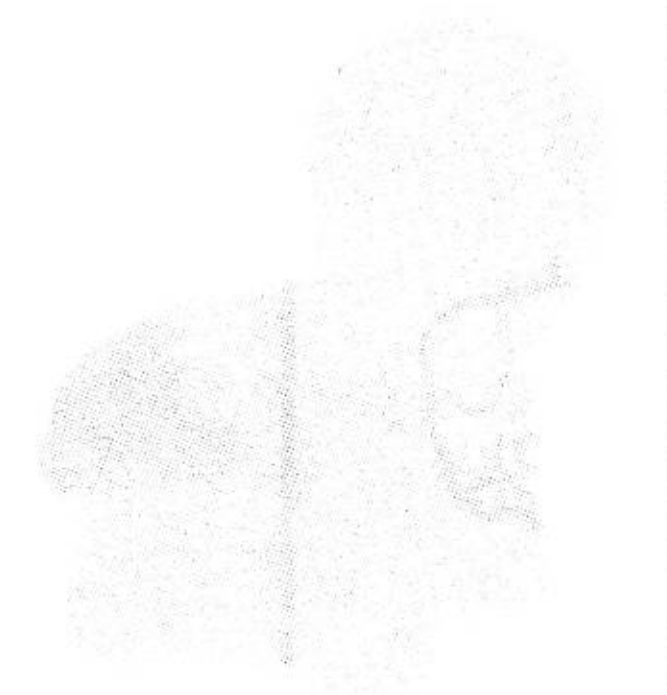

3

				
	ก	ข	ค	ง

4

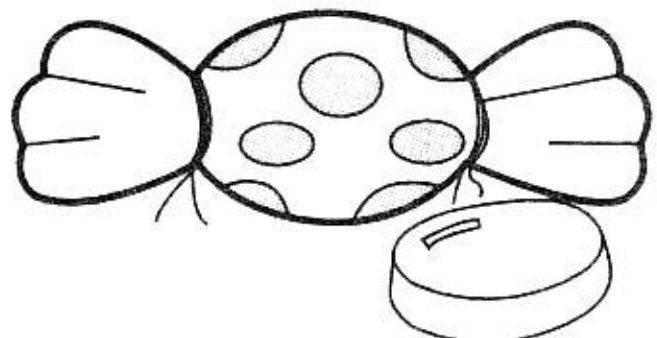
				
	ก	ข	ค	ง

5

				
	ก	ข	ค	ง

6

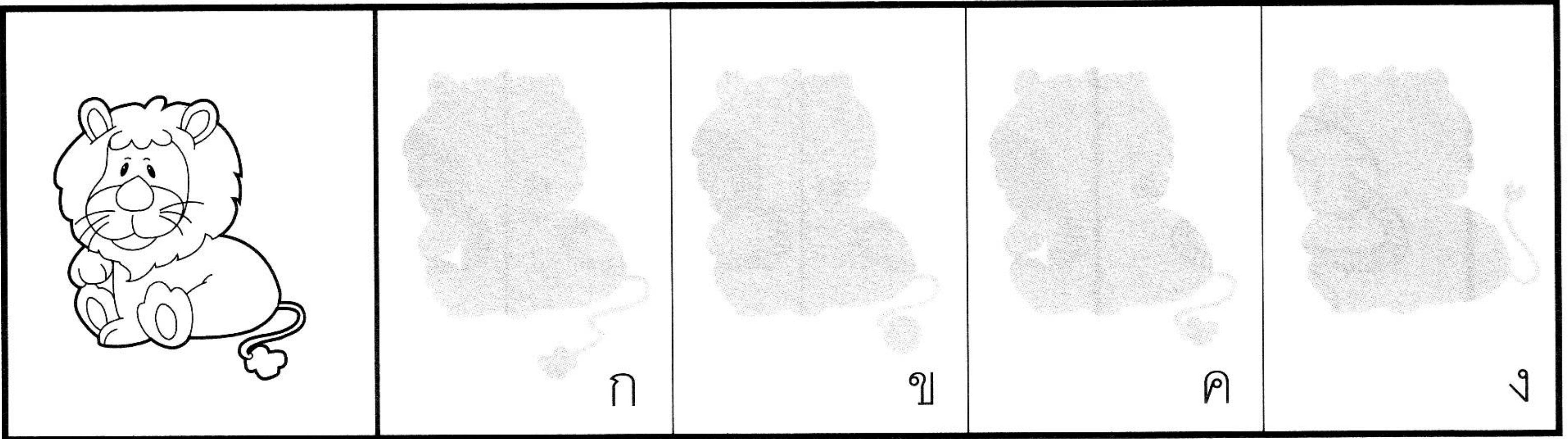

7

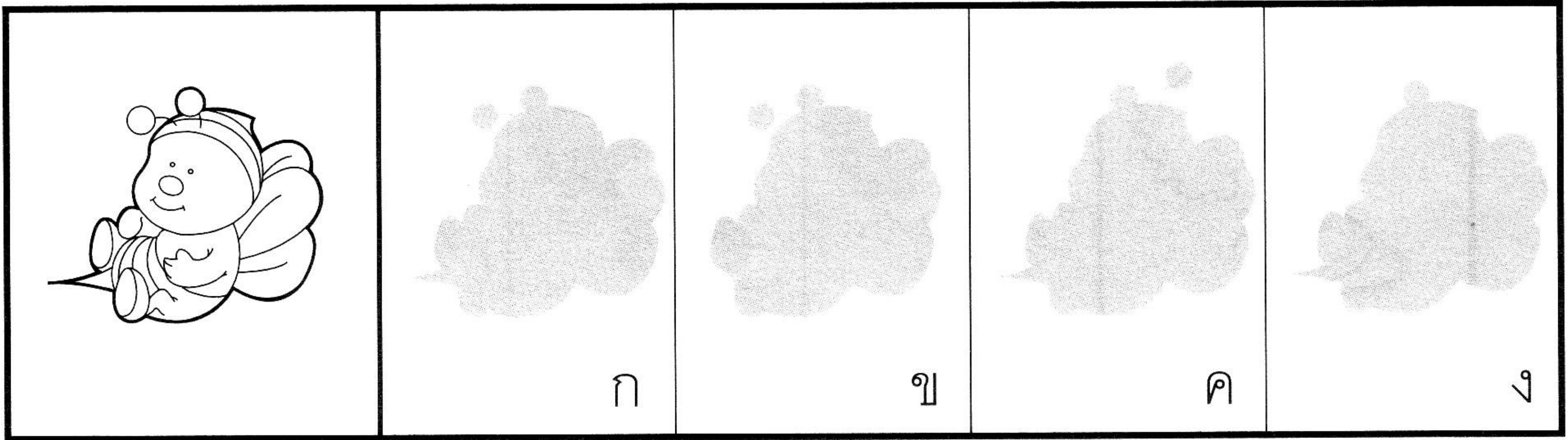

8

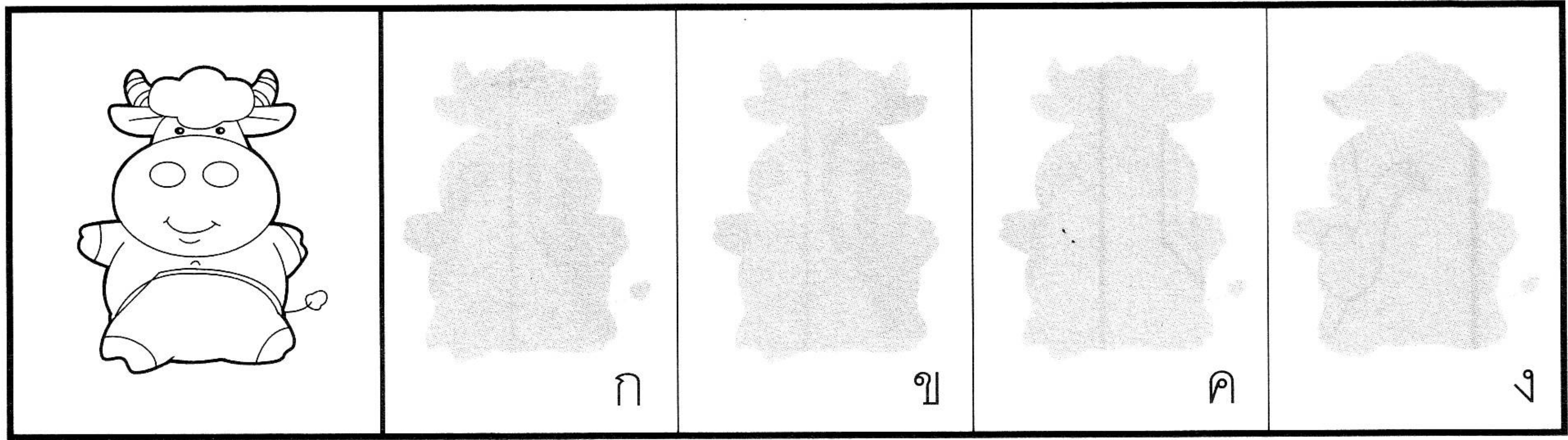

9

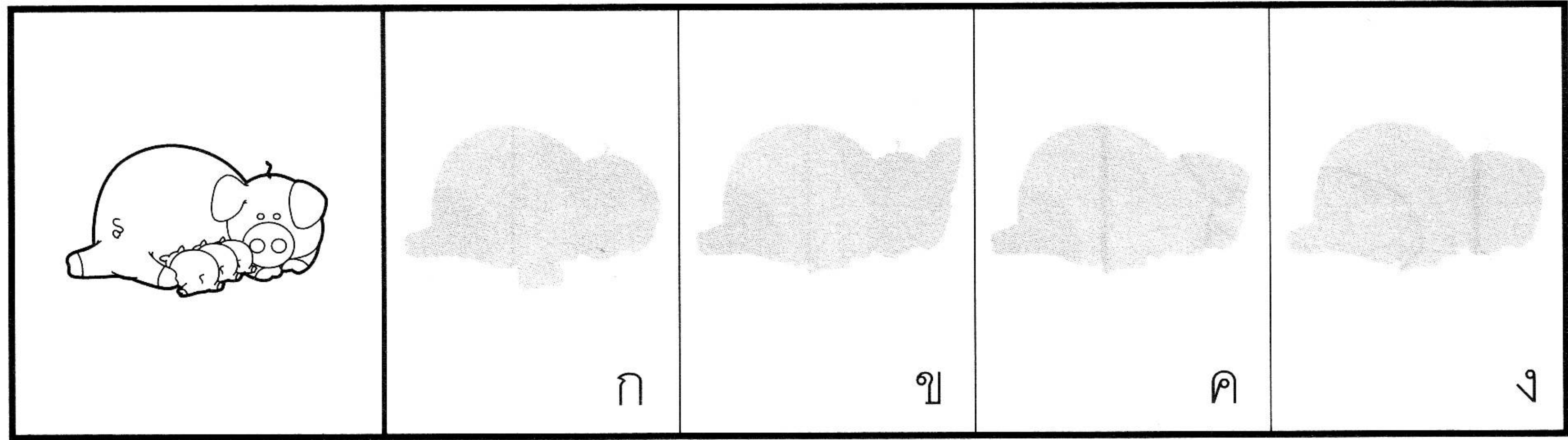

10

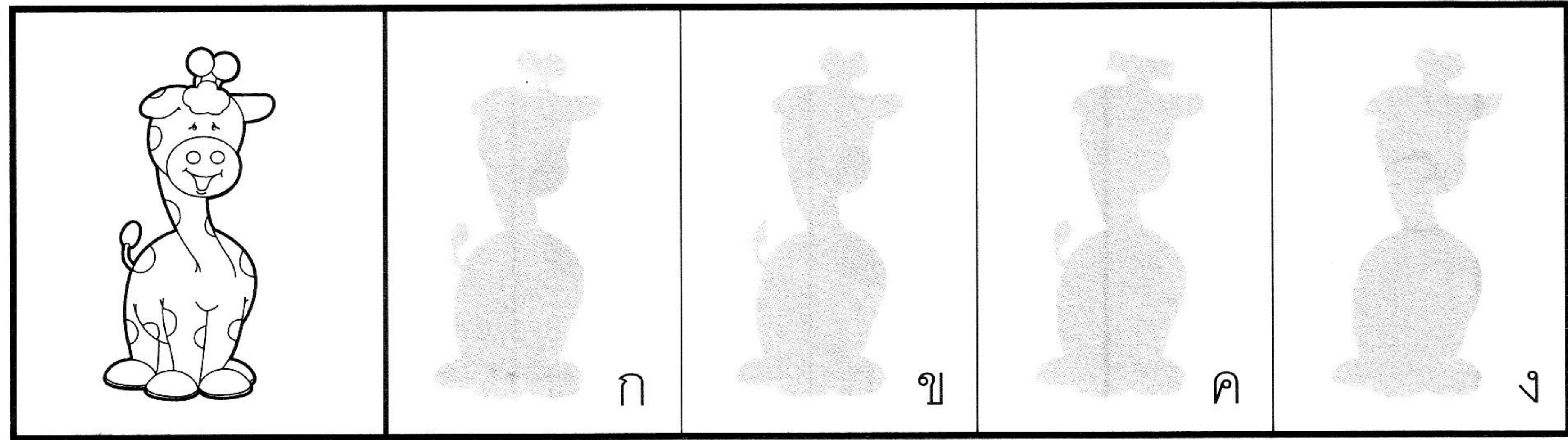

11

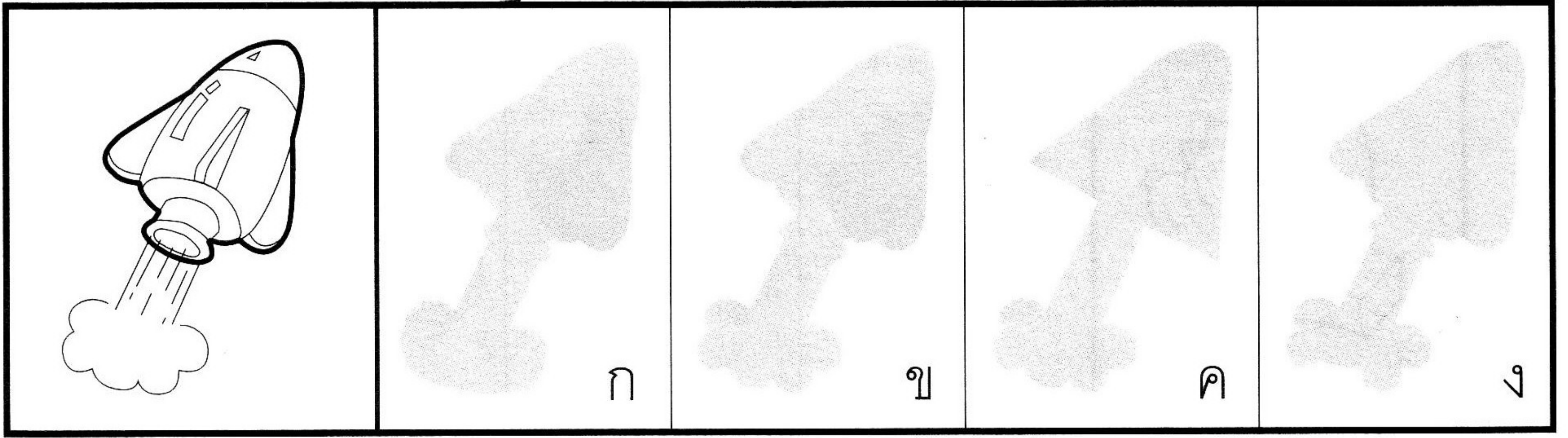

12

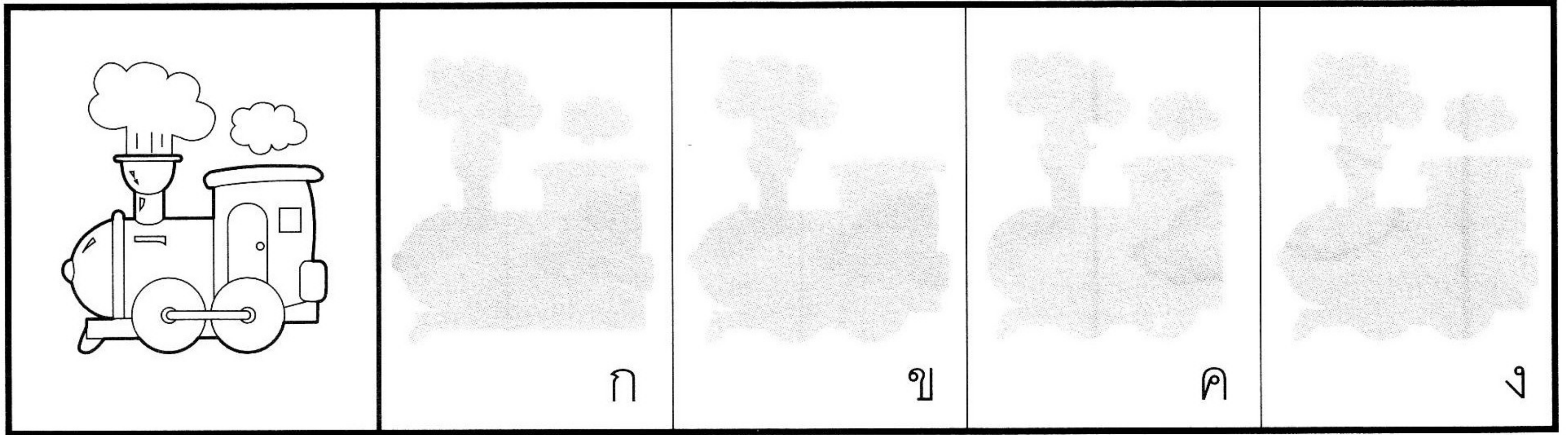

13

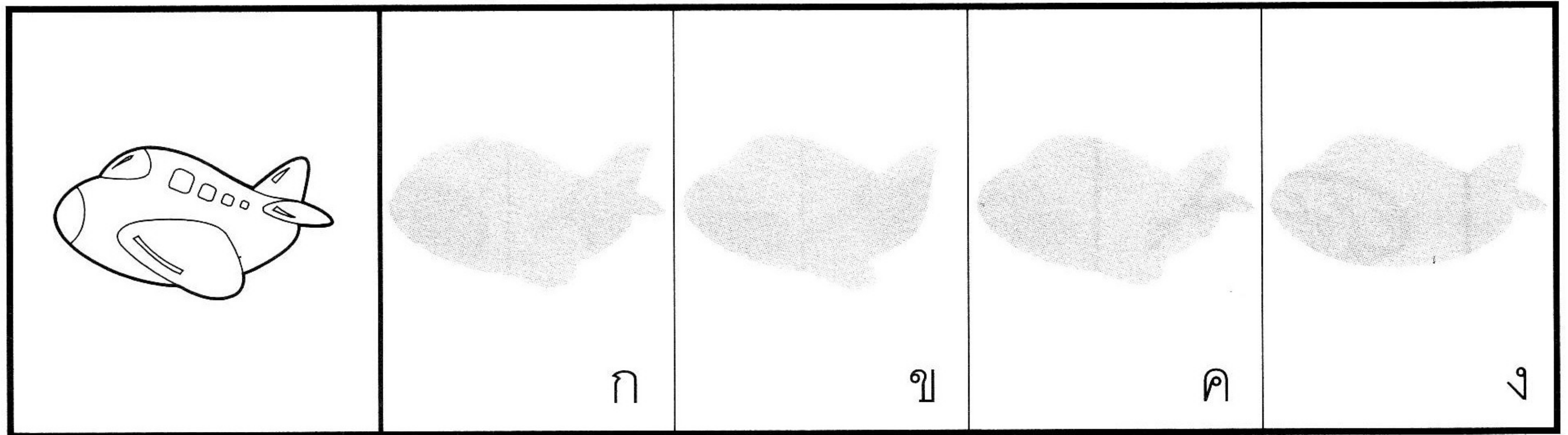

14

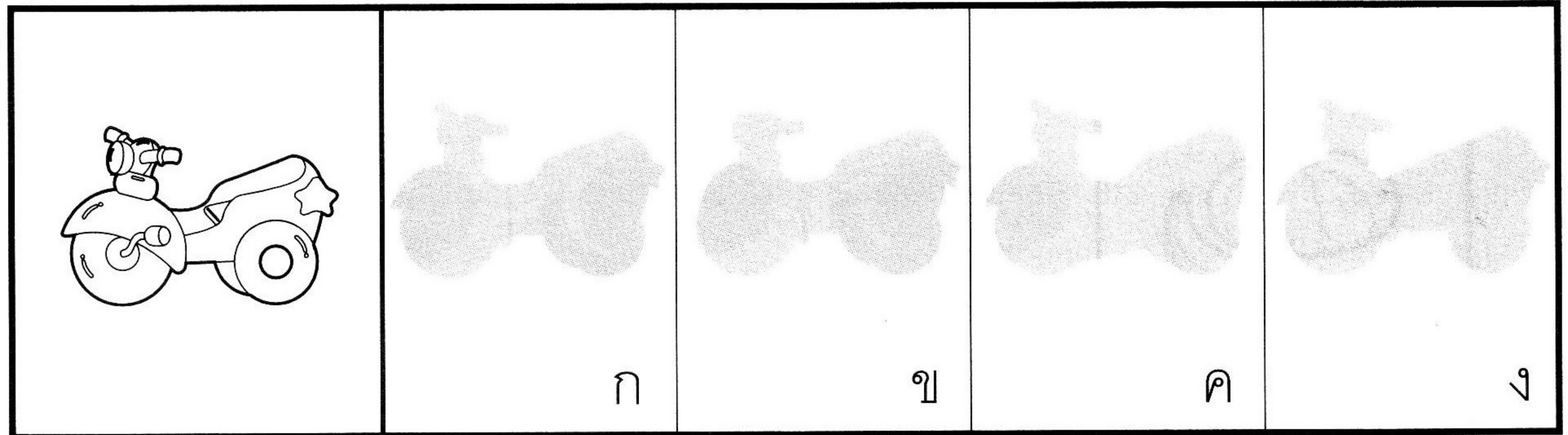

15

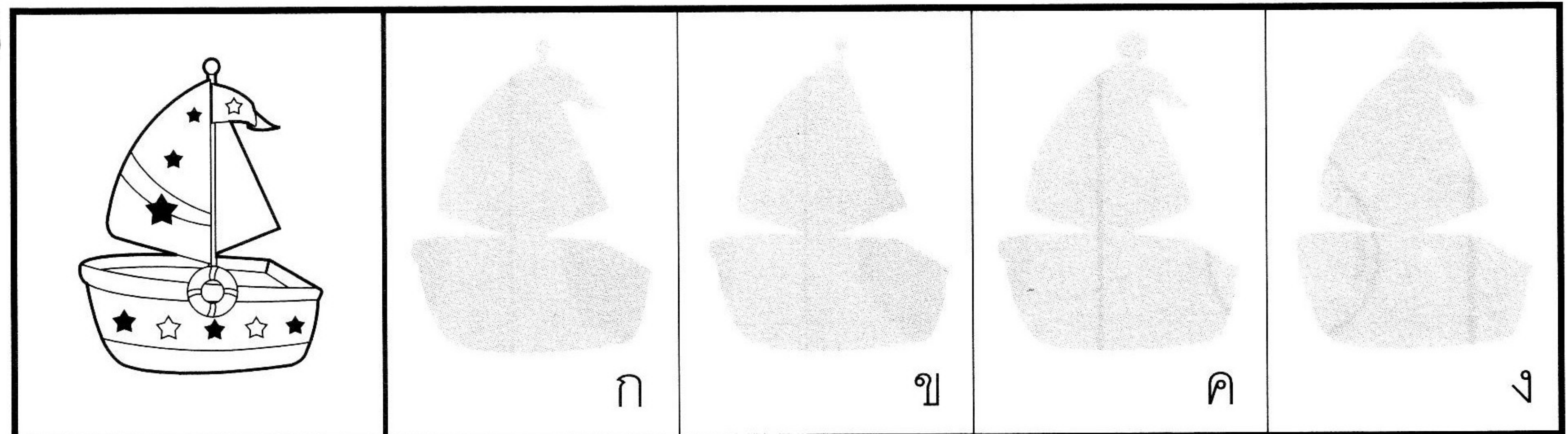

16

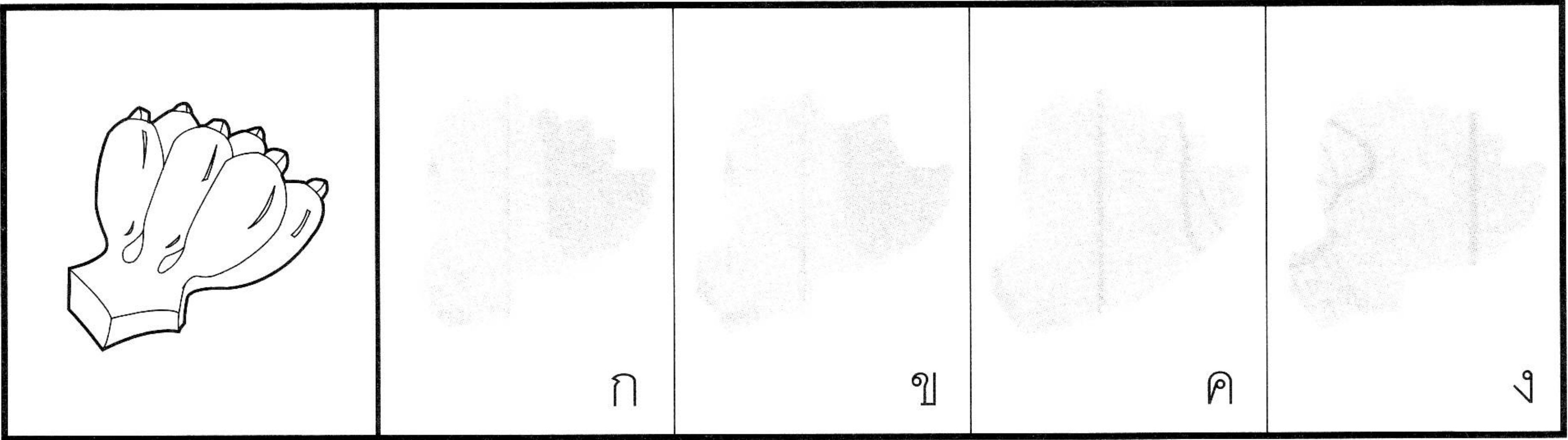

17

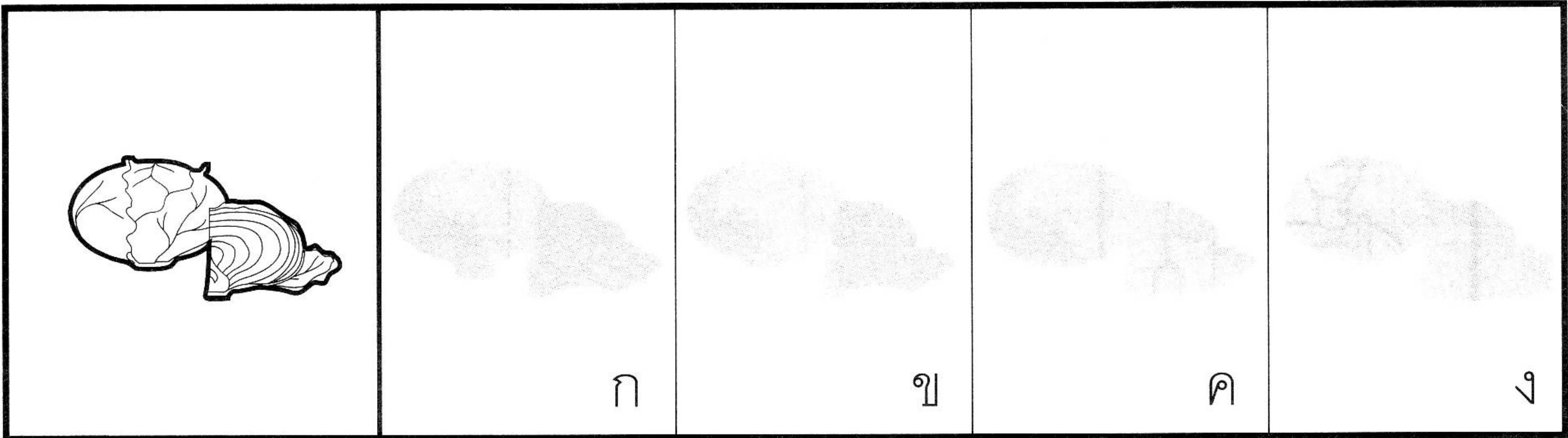

18

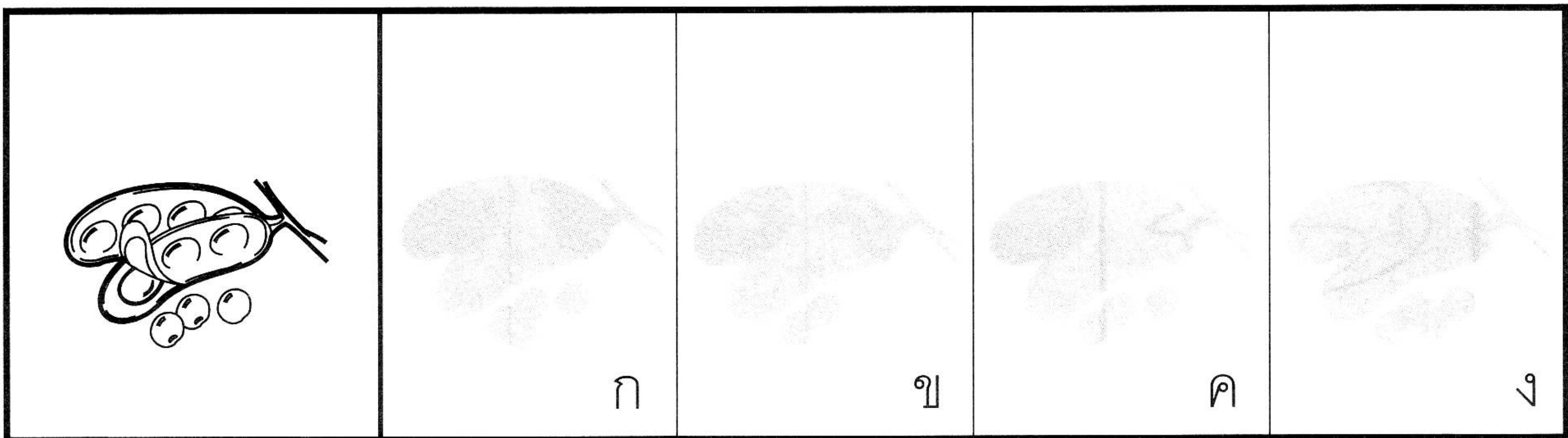

19

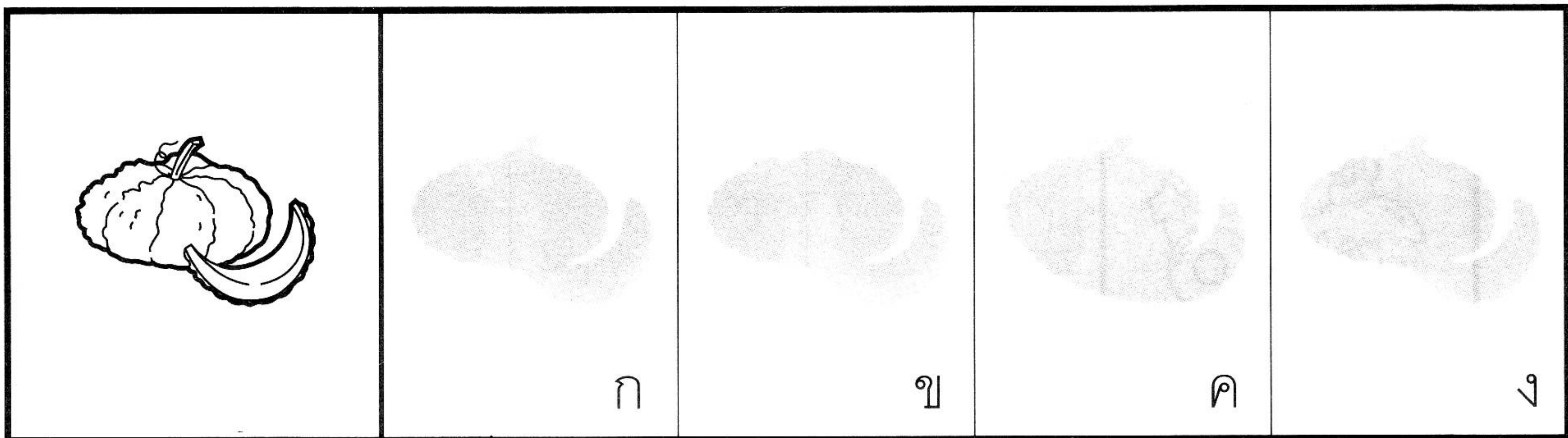

20

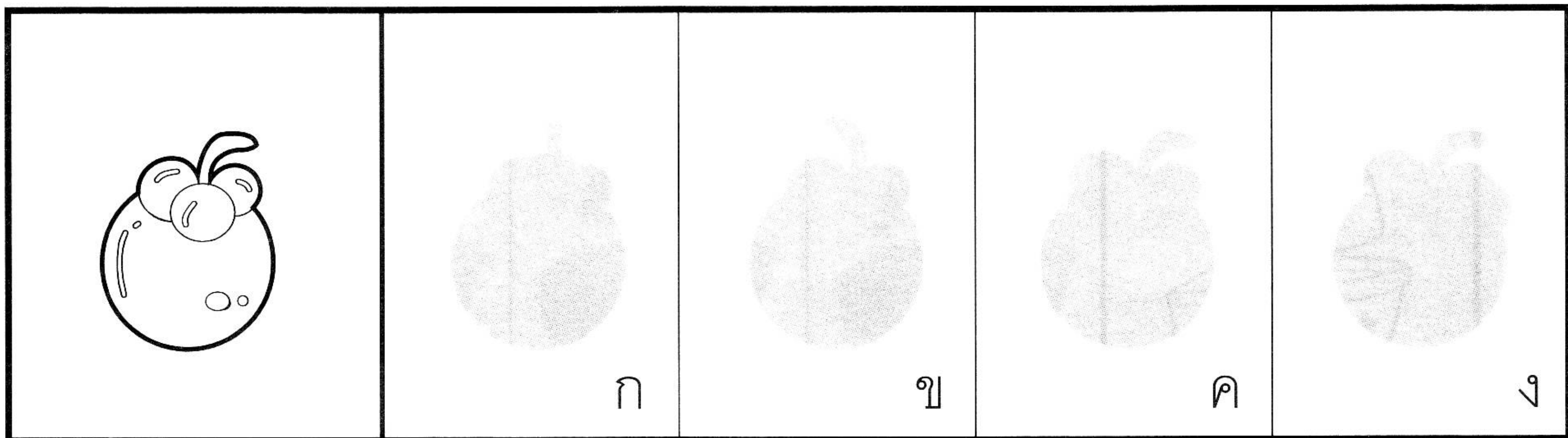

จงขีด ✓ ภาพที่เป็นพวกเดียวกับภาพในช่องแรก



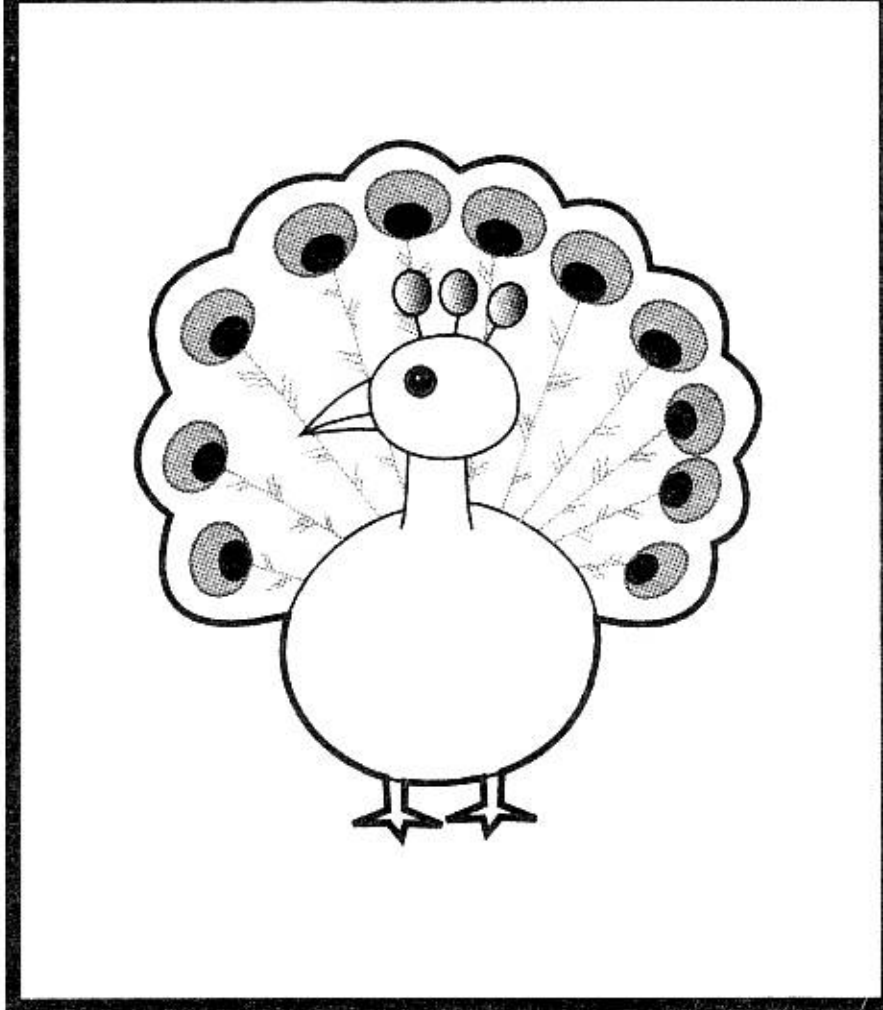
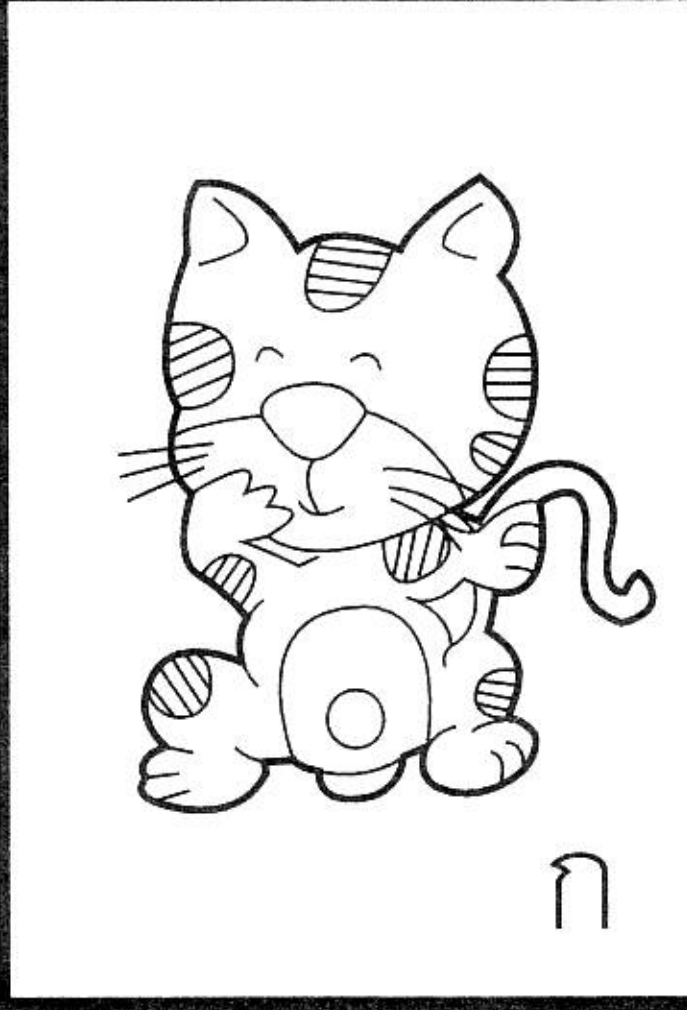
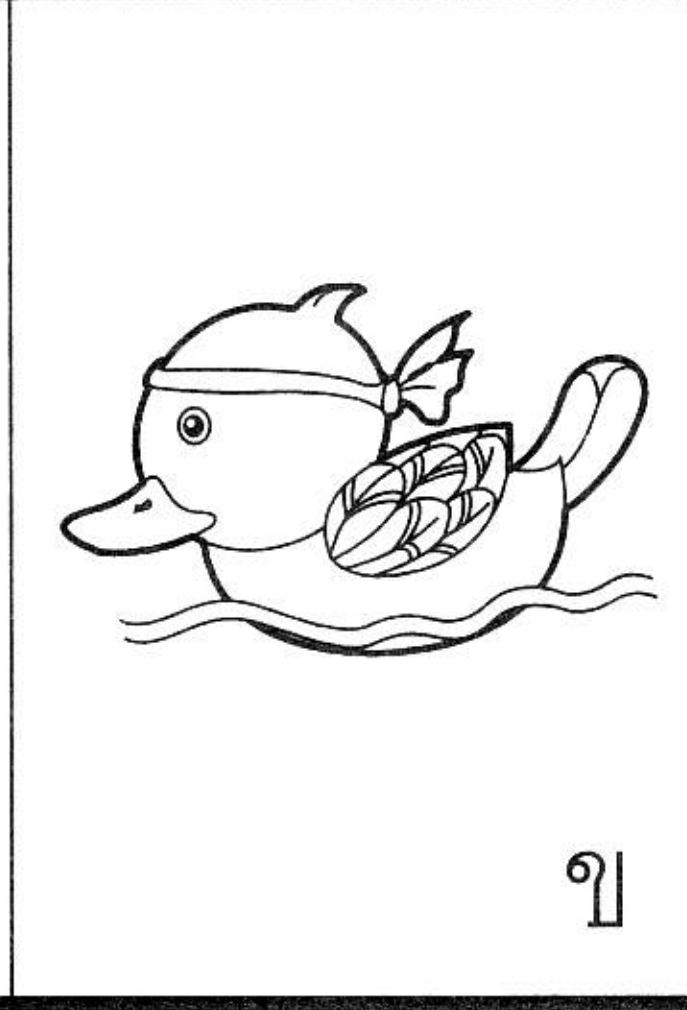
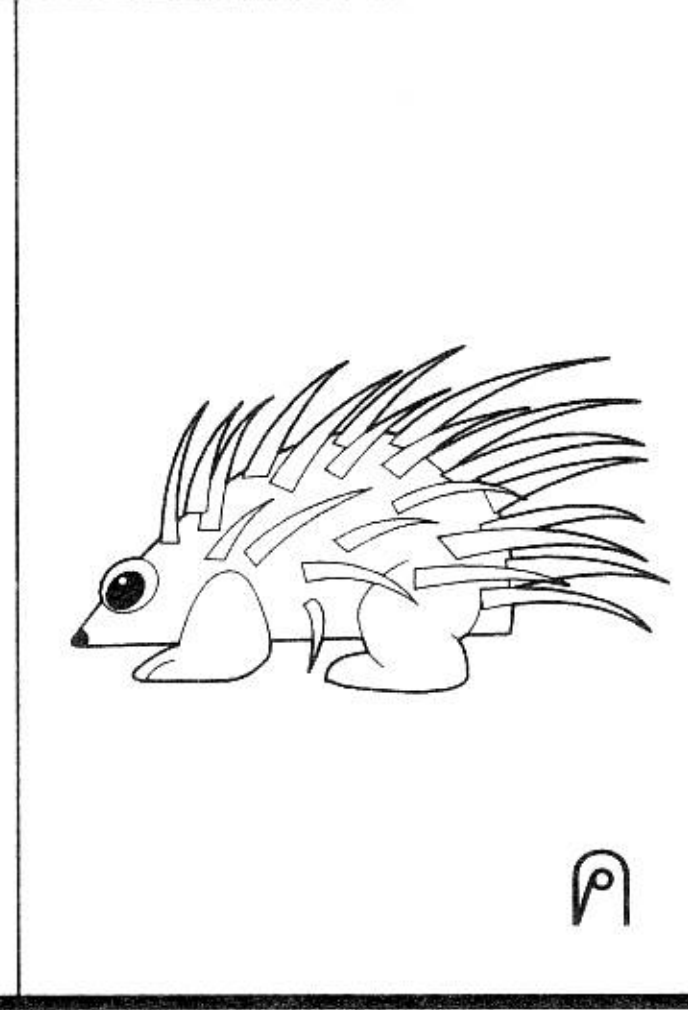
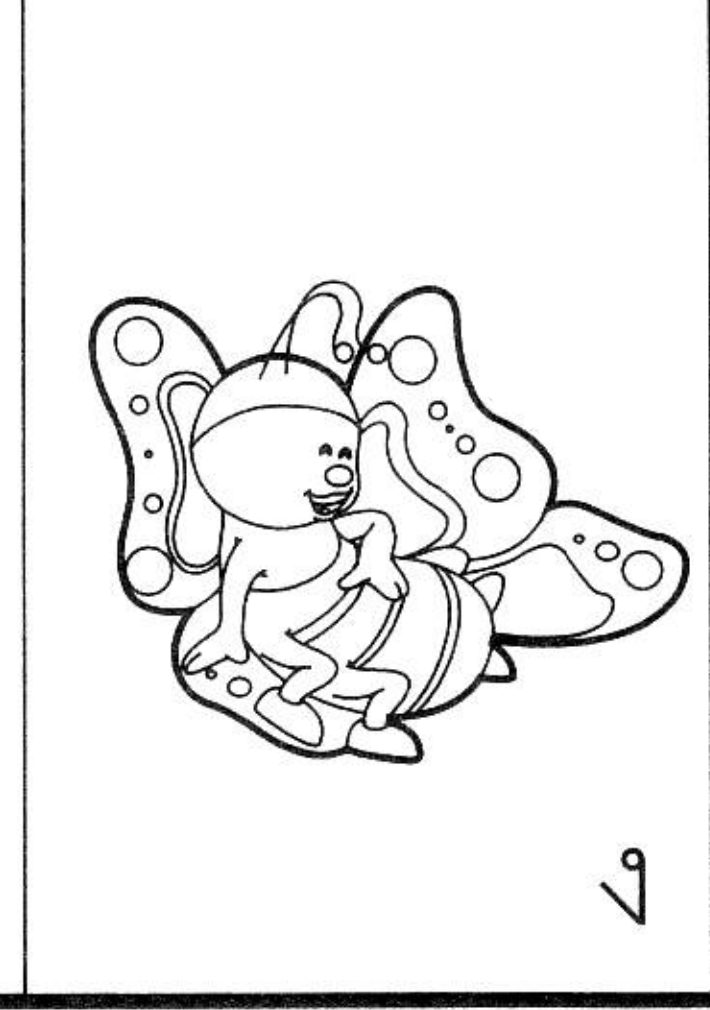

1

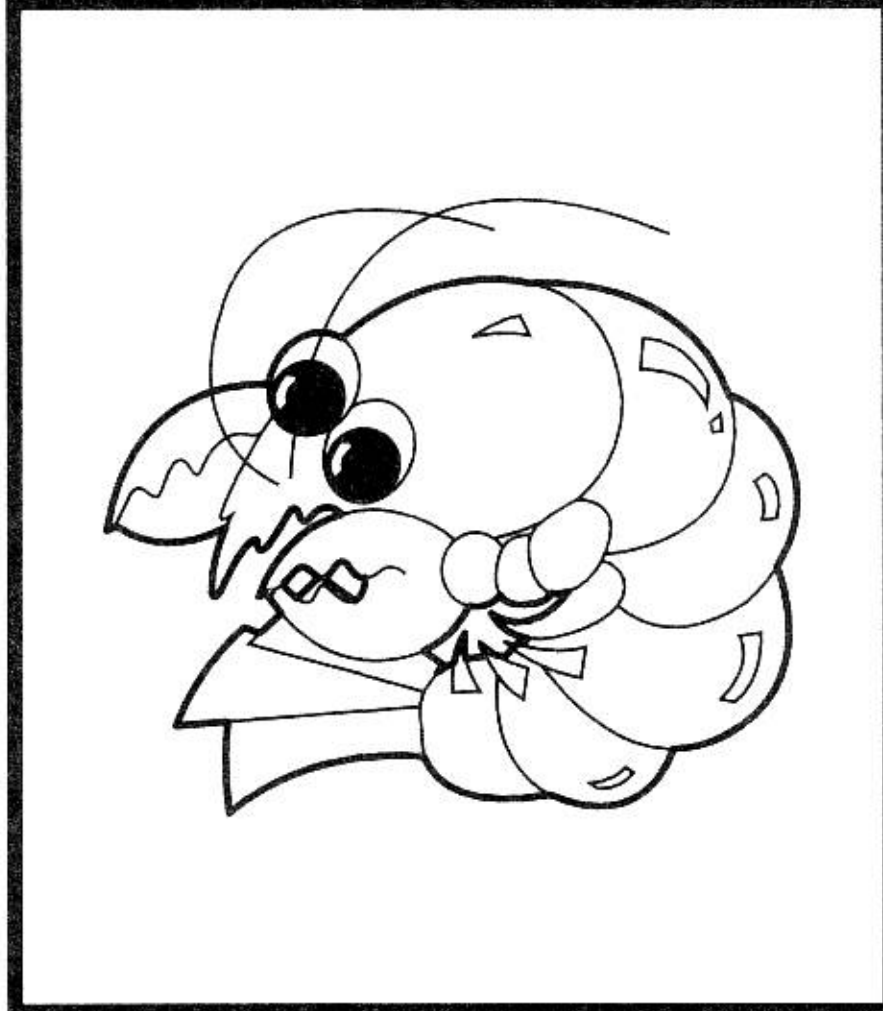
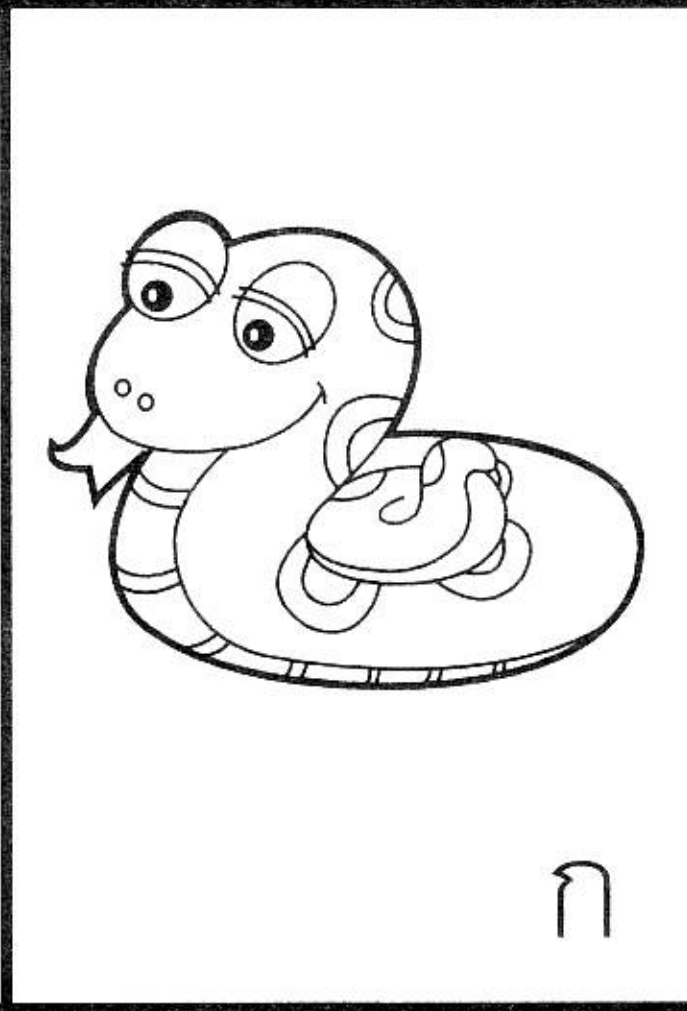
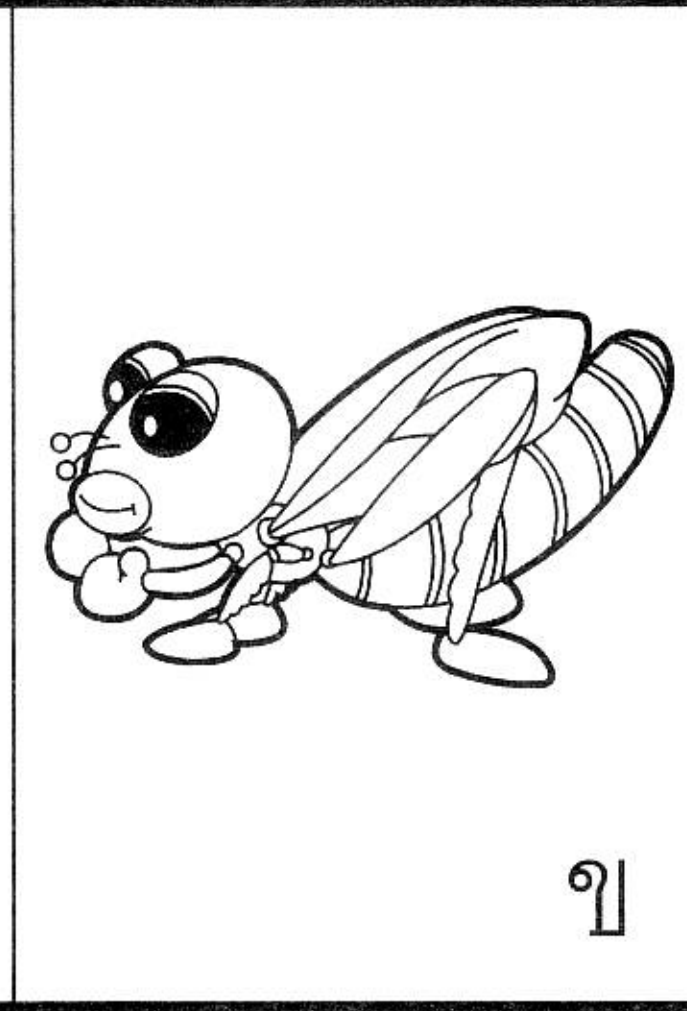
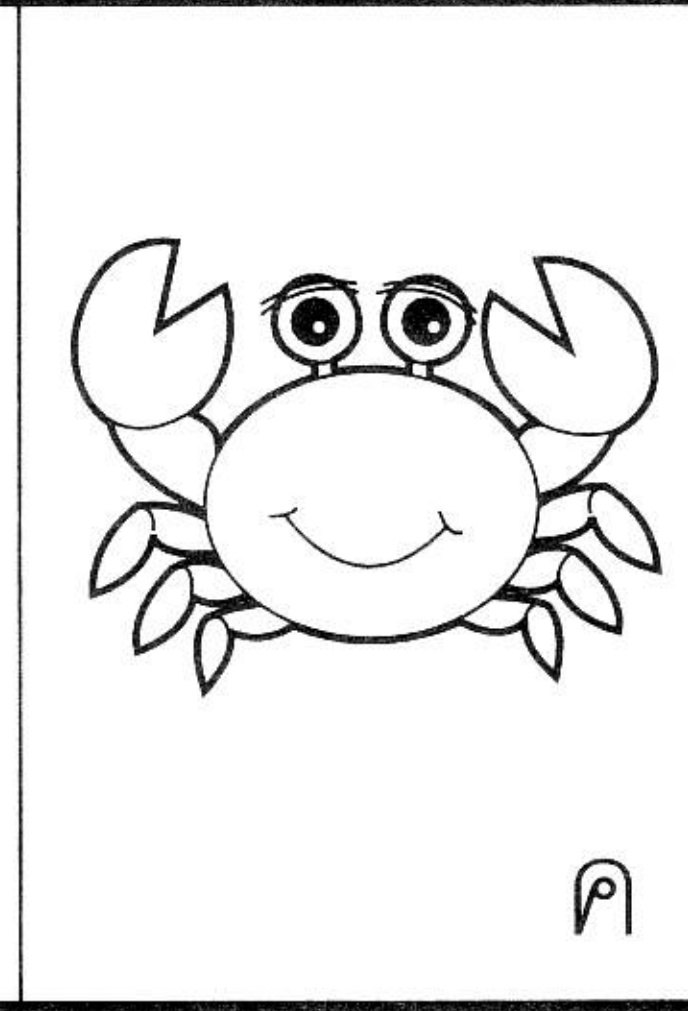
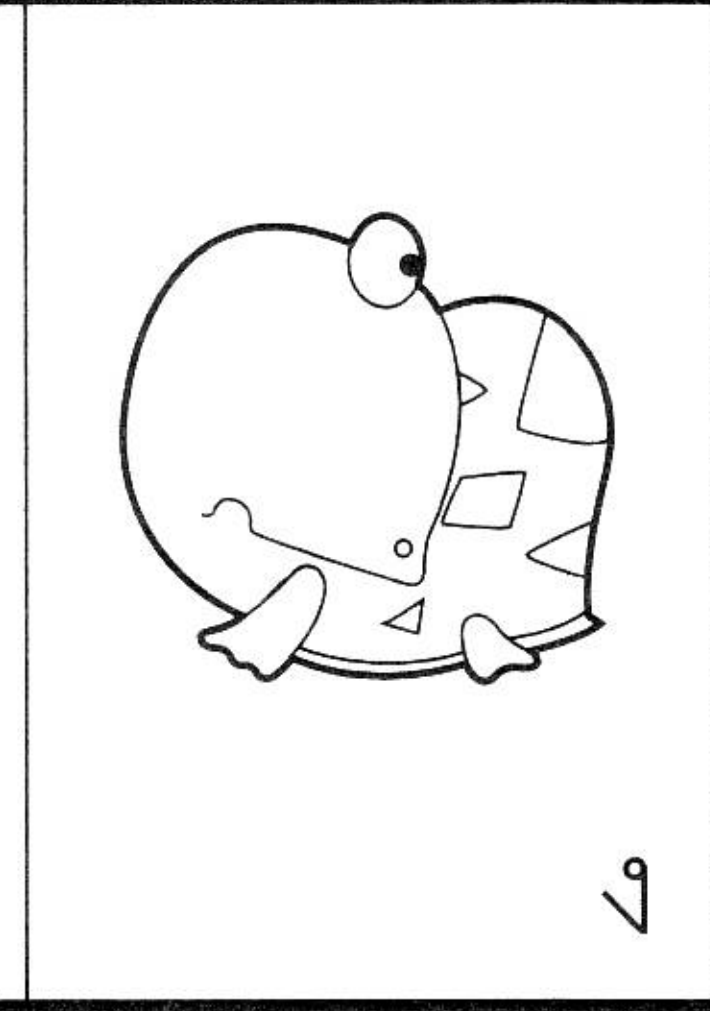
	 ก	 ข	 ค	 ง
---	--	---	--	--

2

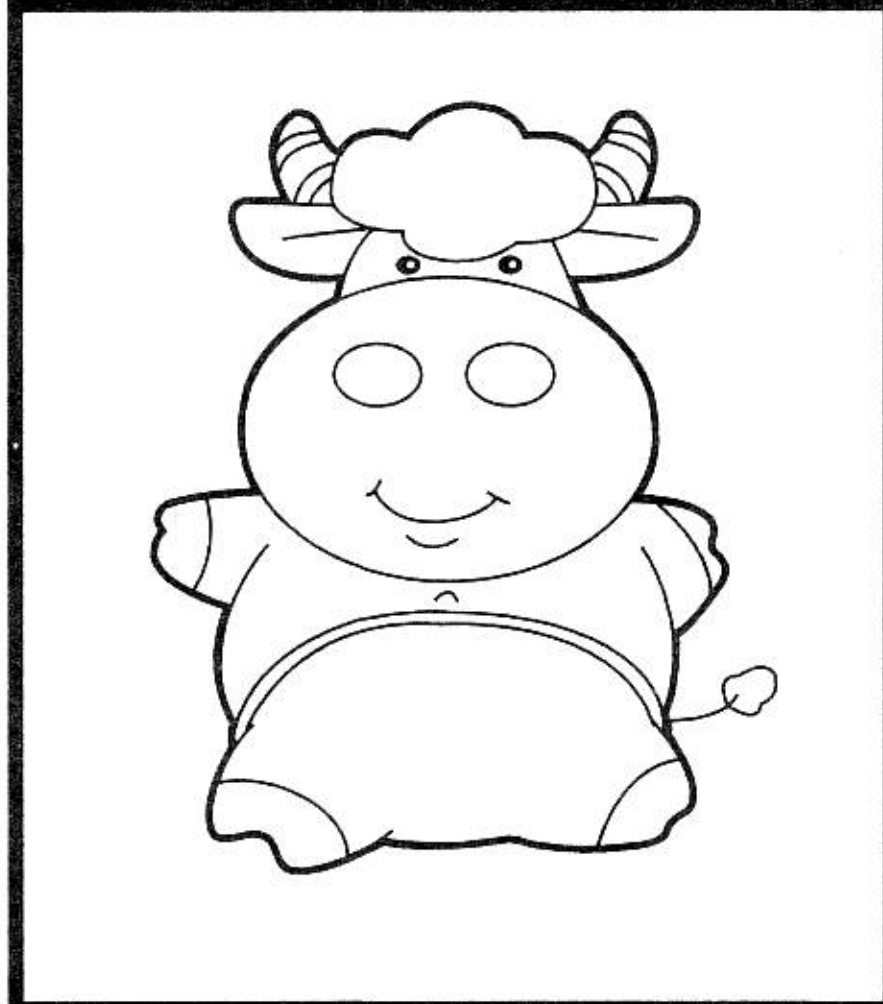
	 ก	 ข	 ค	 ง
--	---	--	---	---

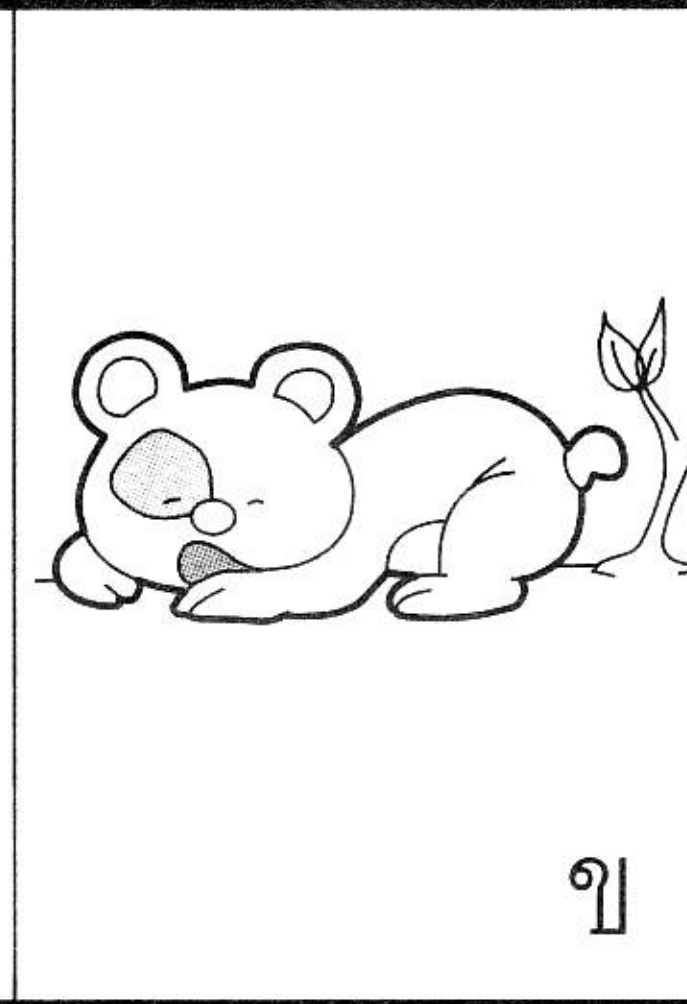
3

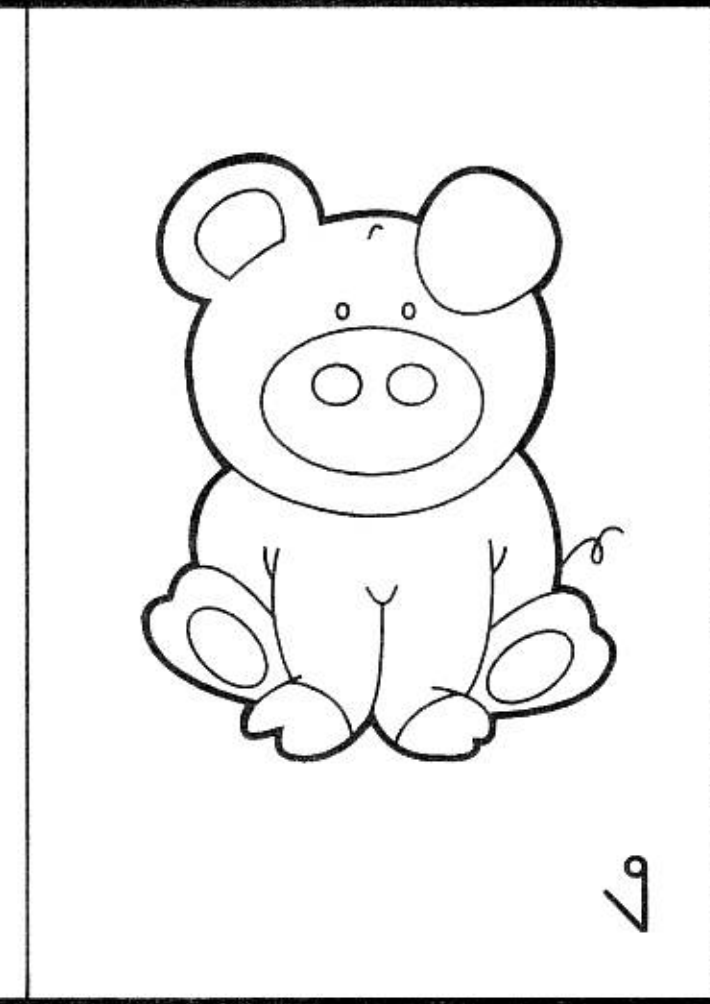
	 ก	 ข	 ค	 ง
---	--	---	--	--

4

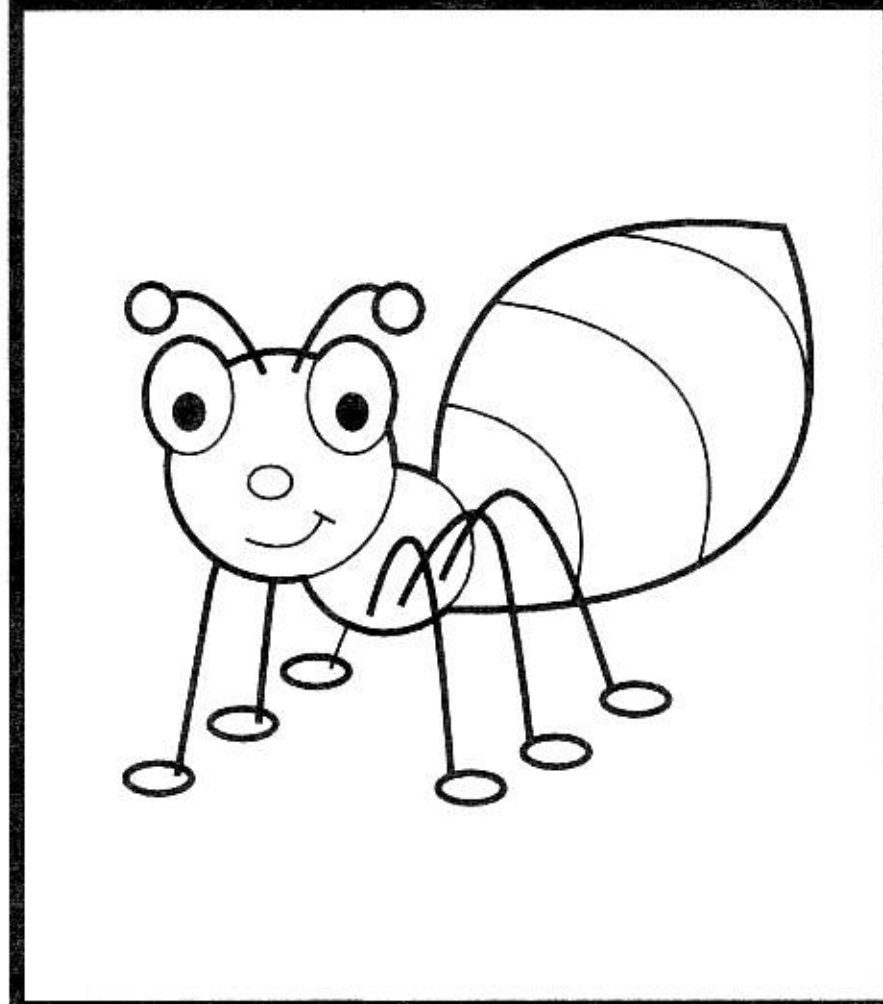
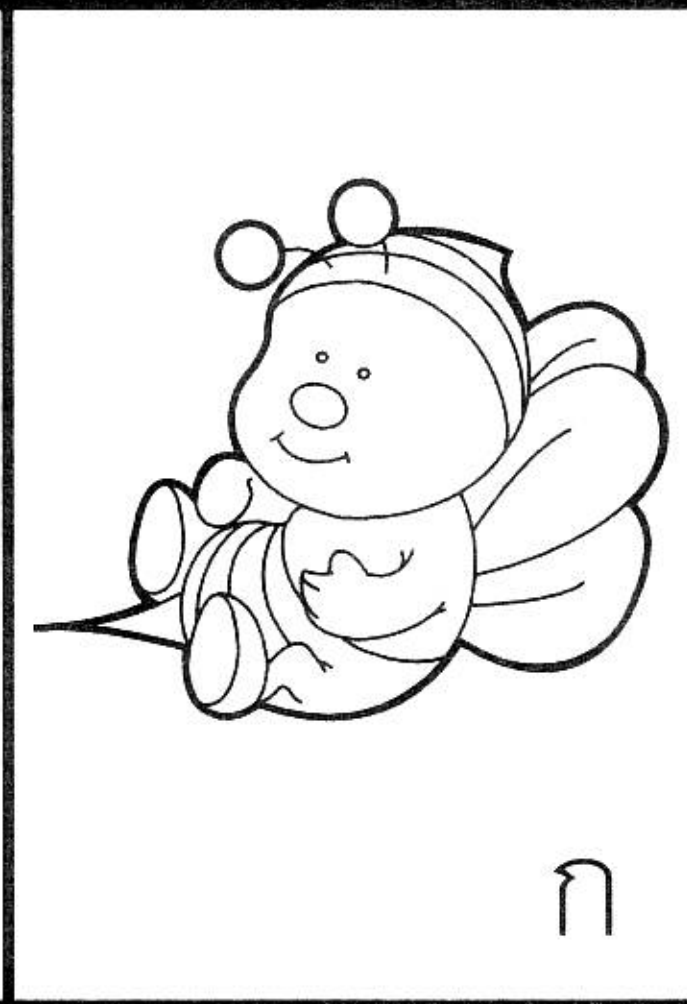
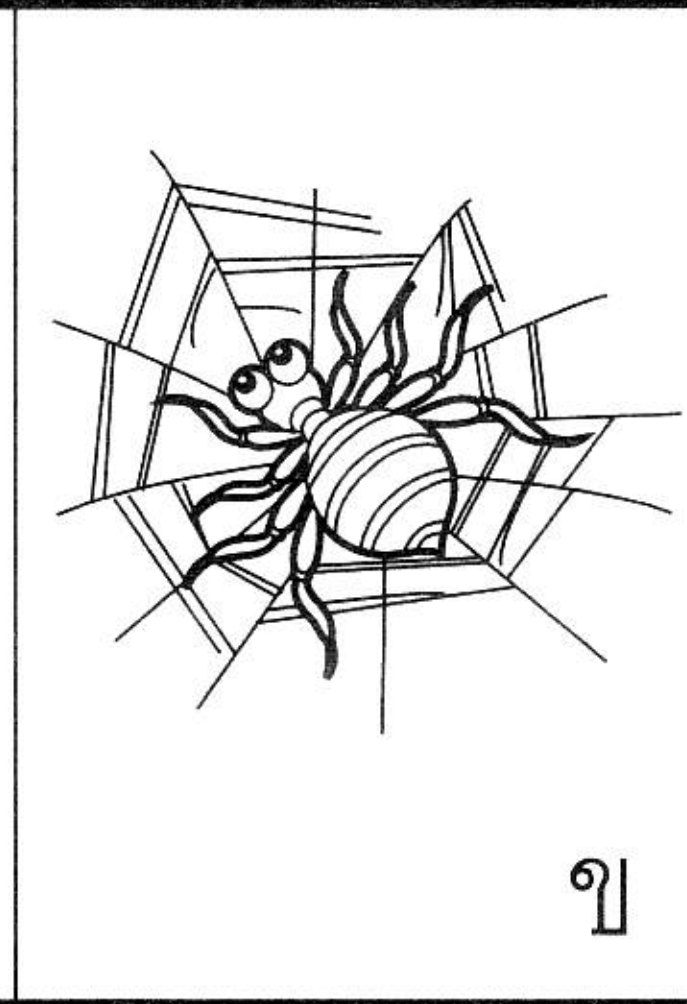
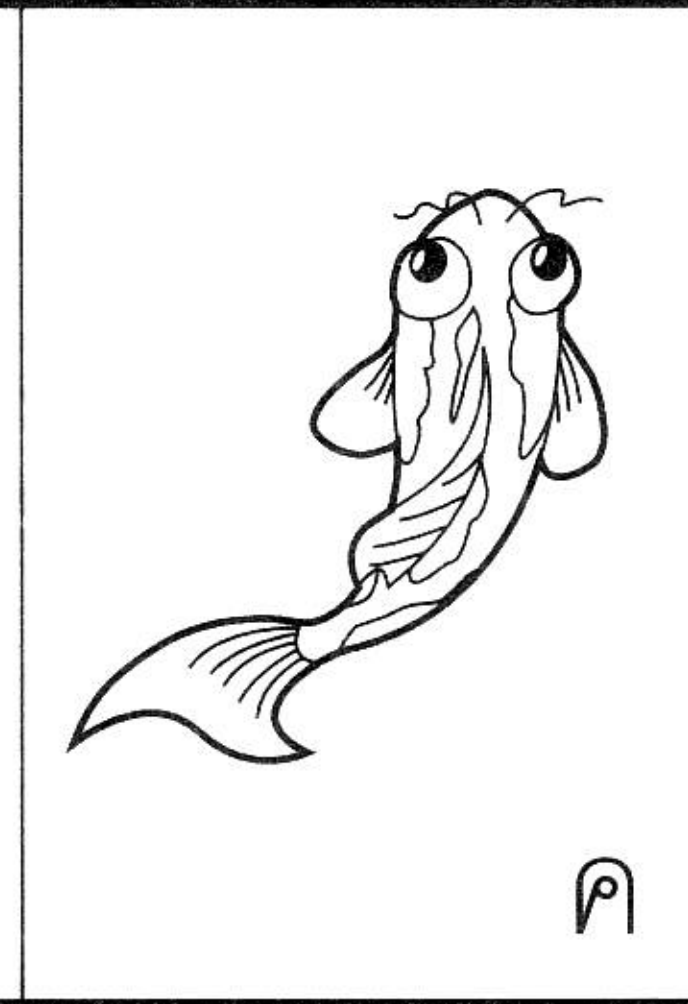
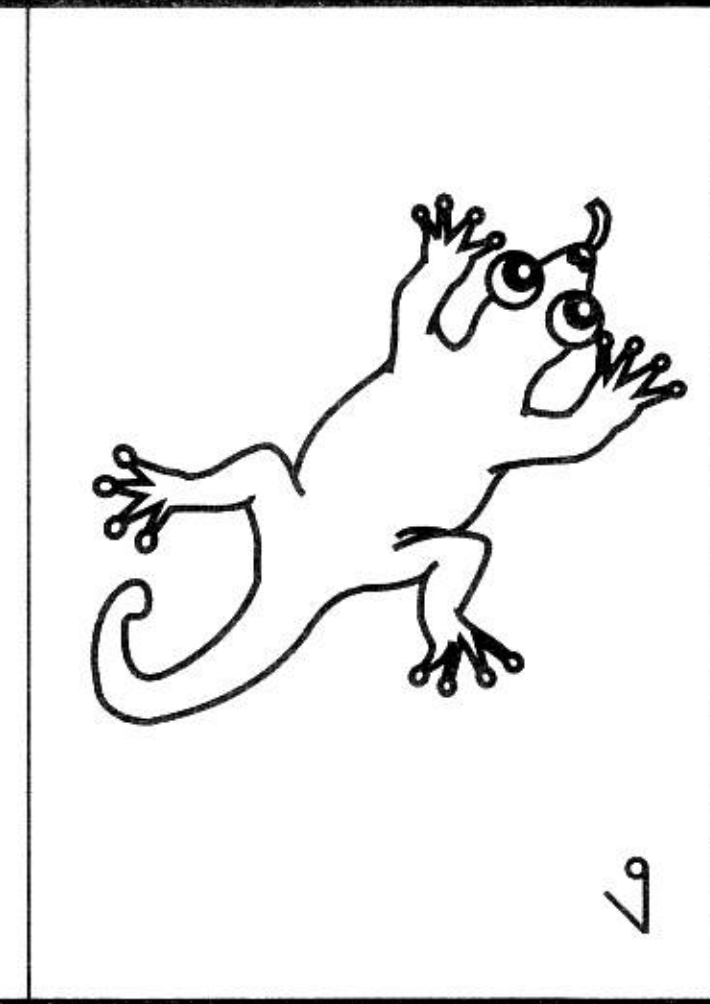
	 ก	 ข	 ค	 ง
---	--	---	--	--

5

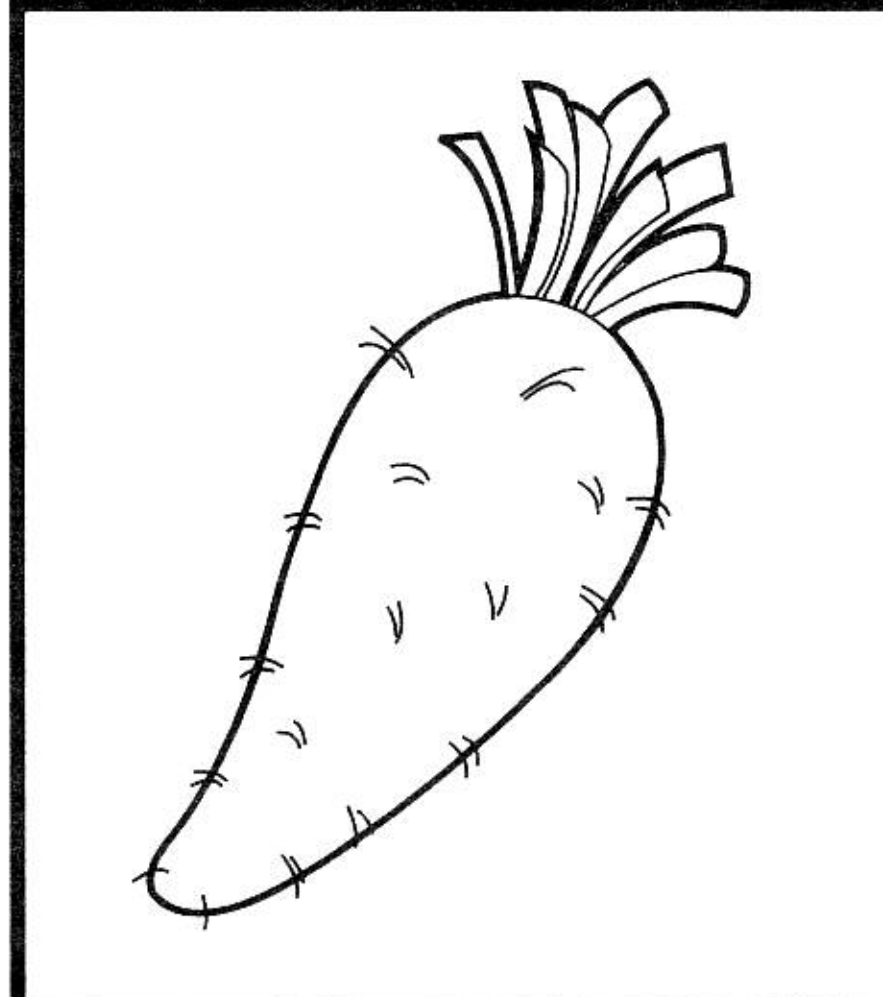
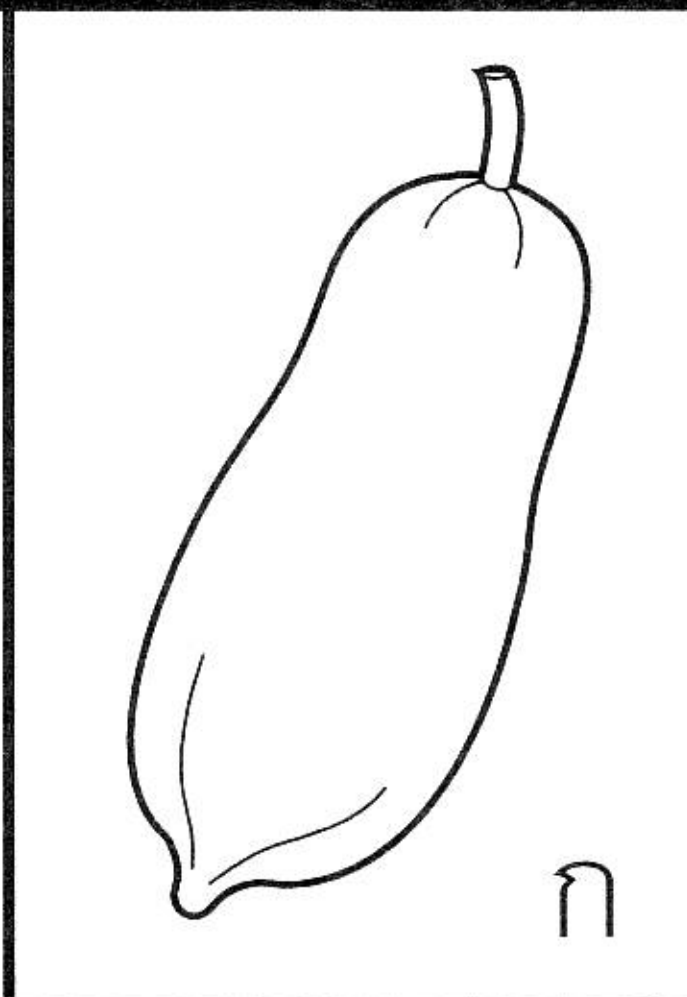
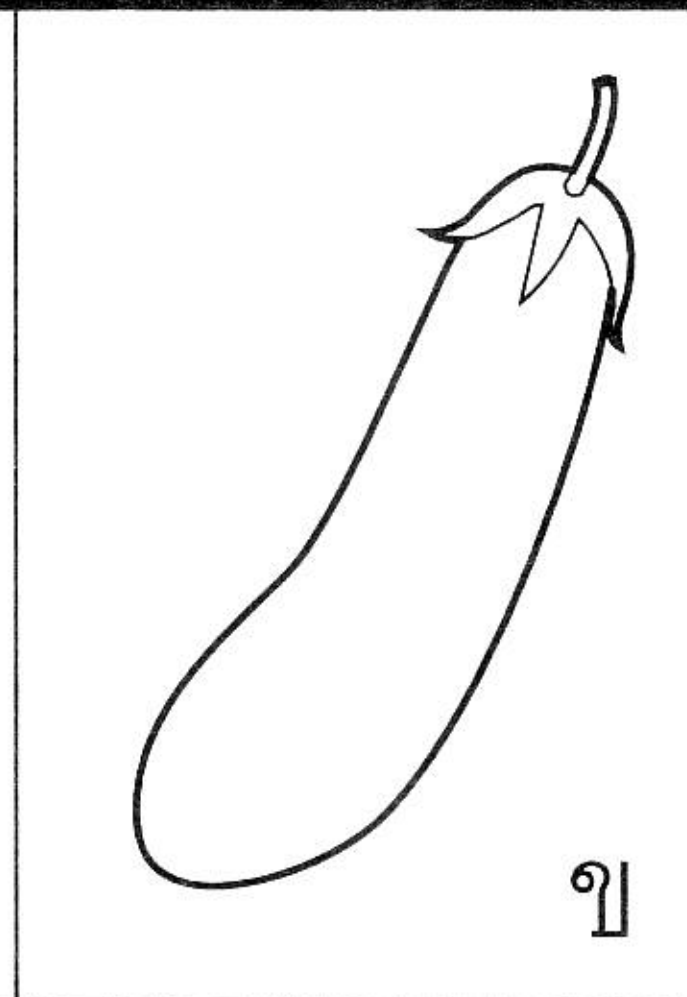
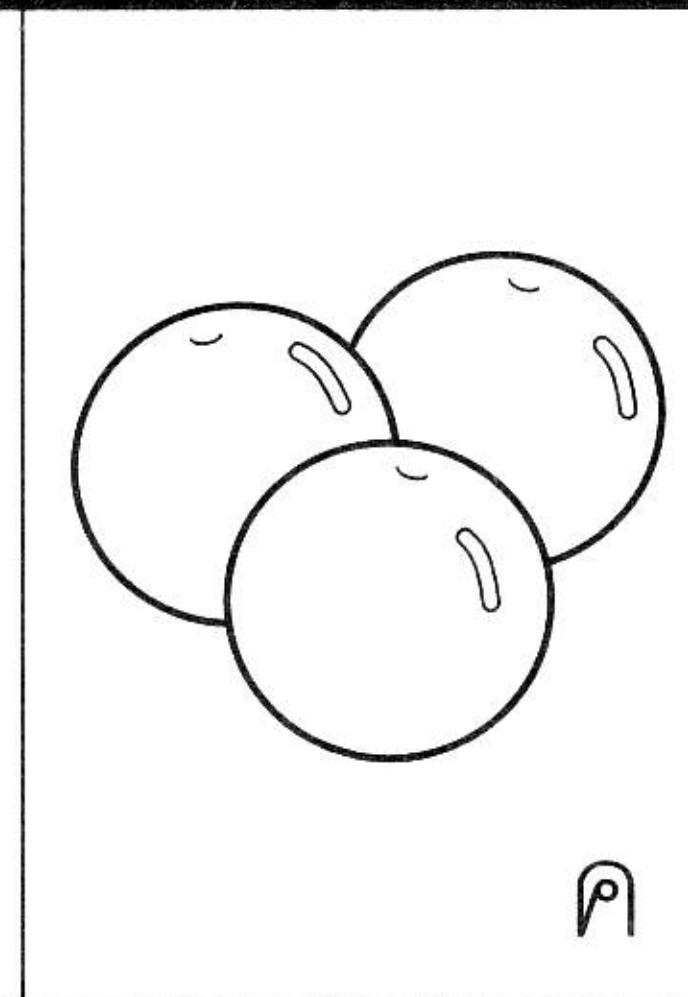
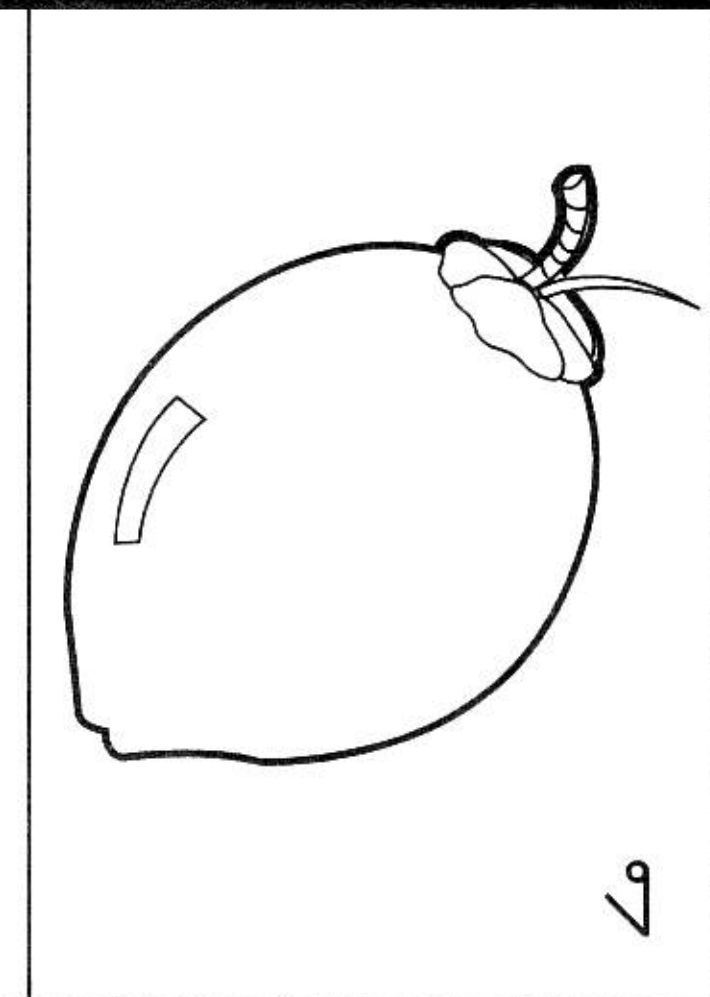
	 ก	 ข	 ค	 ง
---	--	---	--	--

6

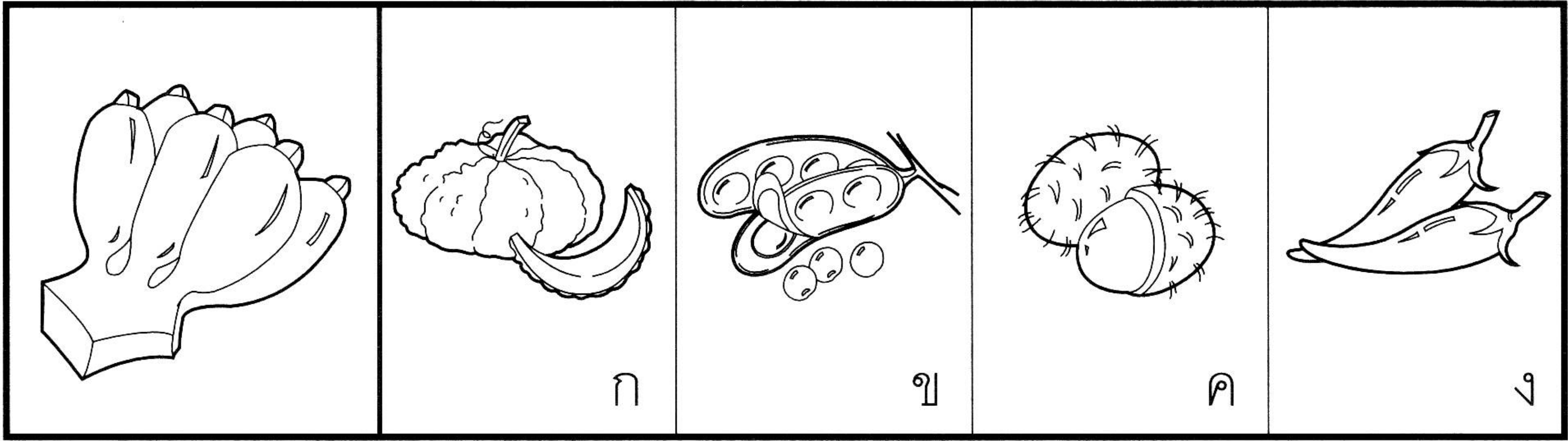

7

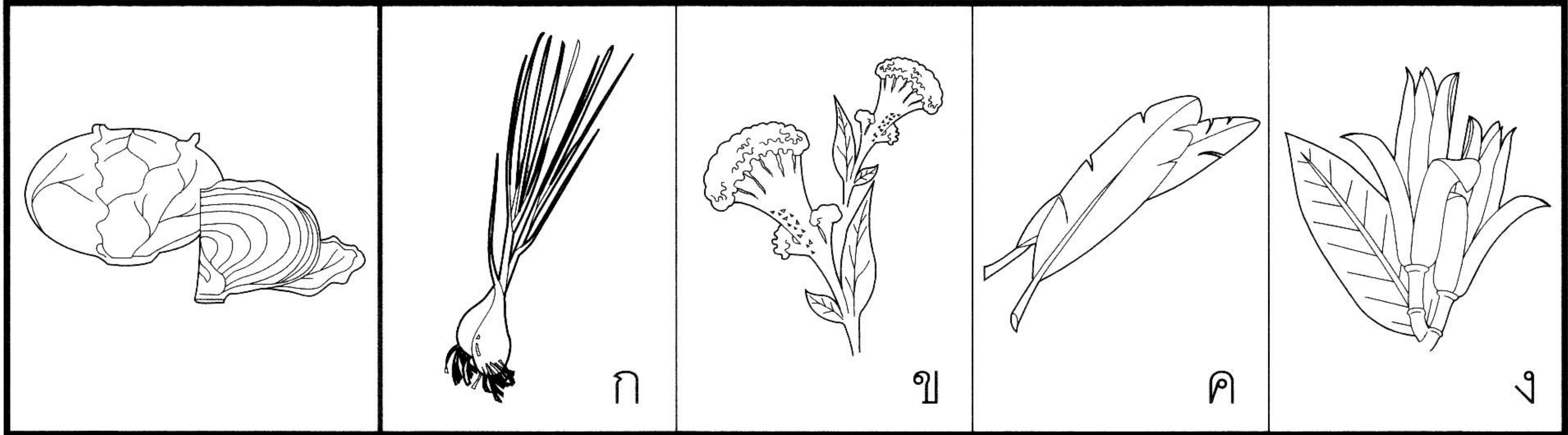

8

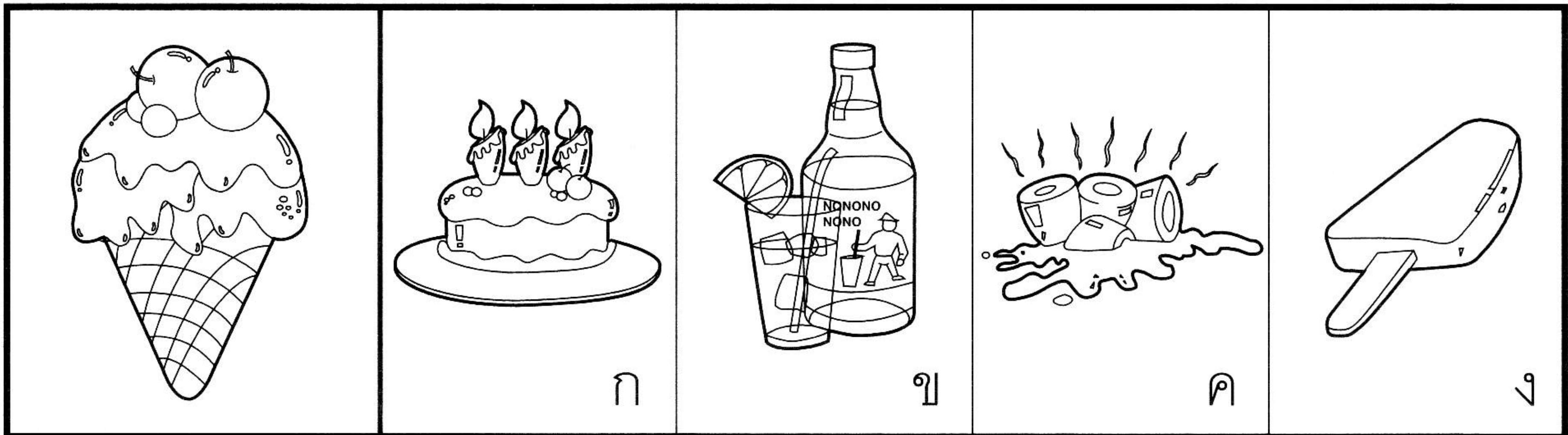

9

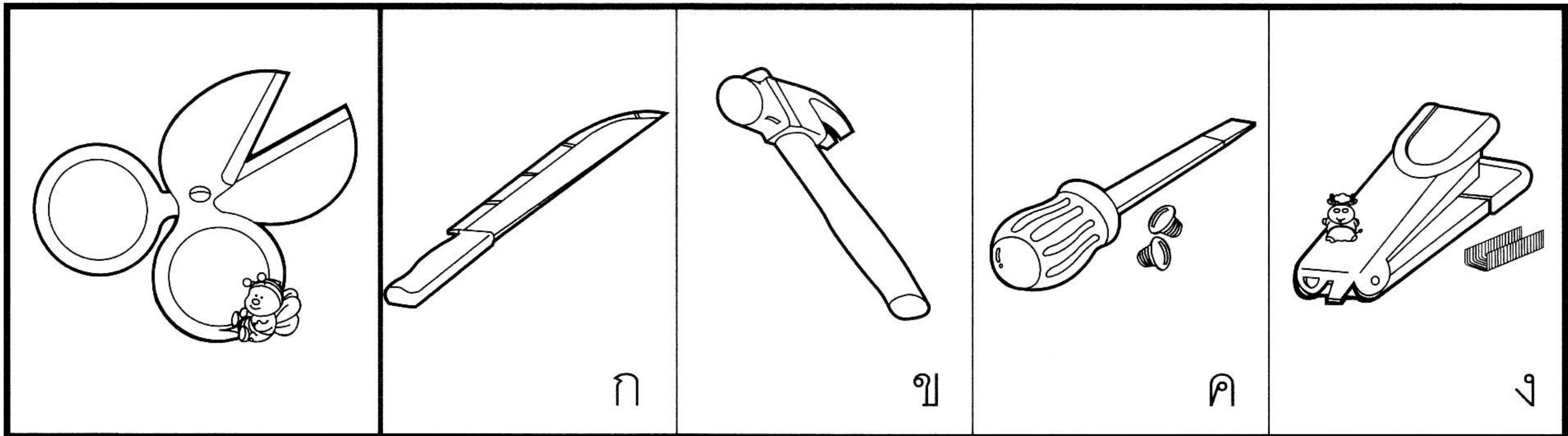

10

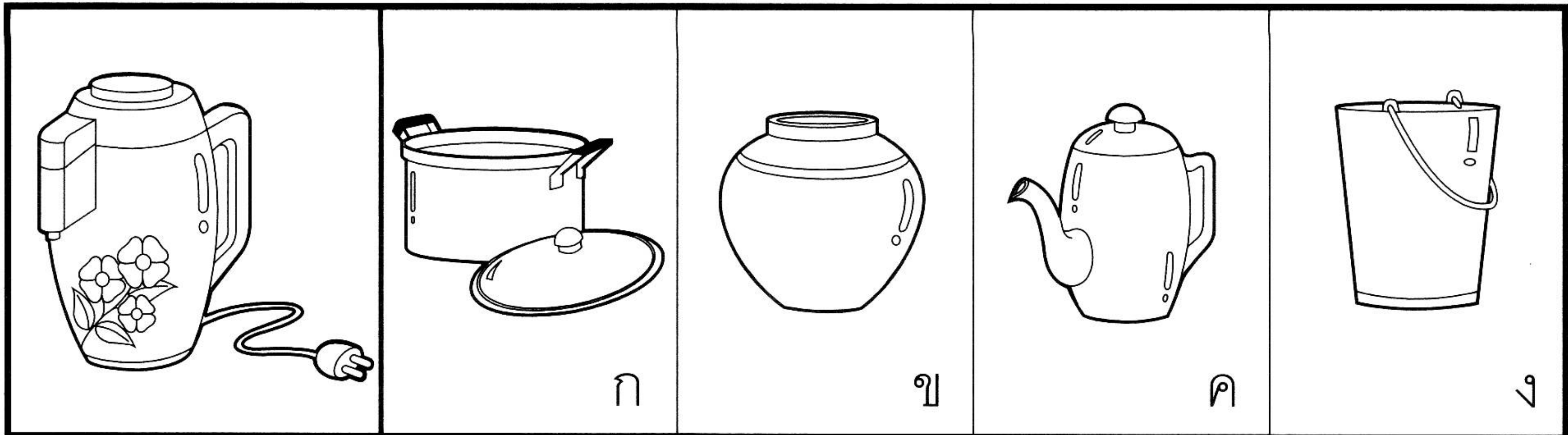

11

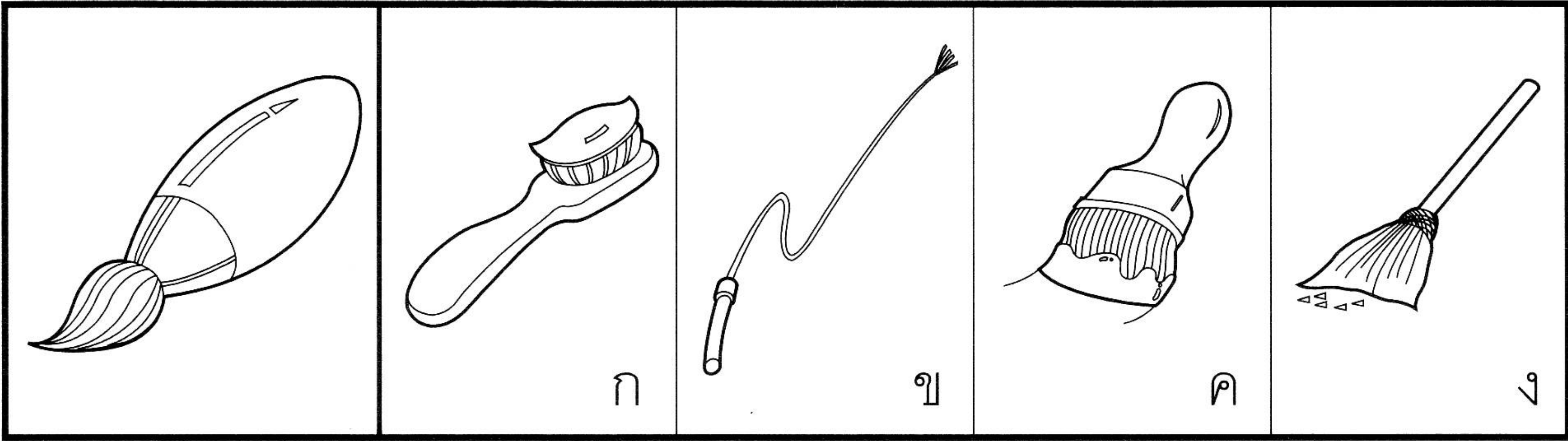

12

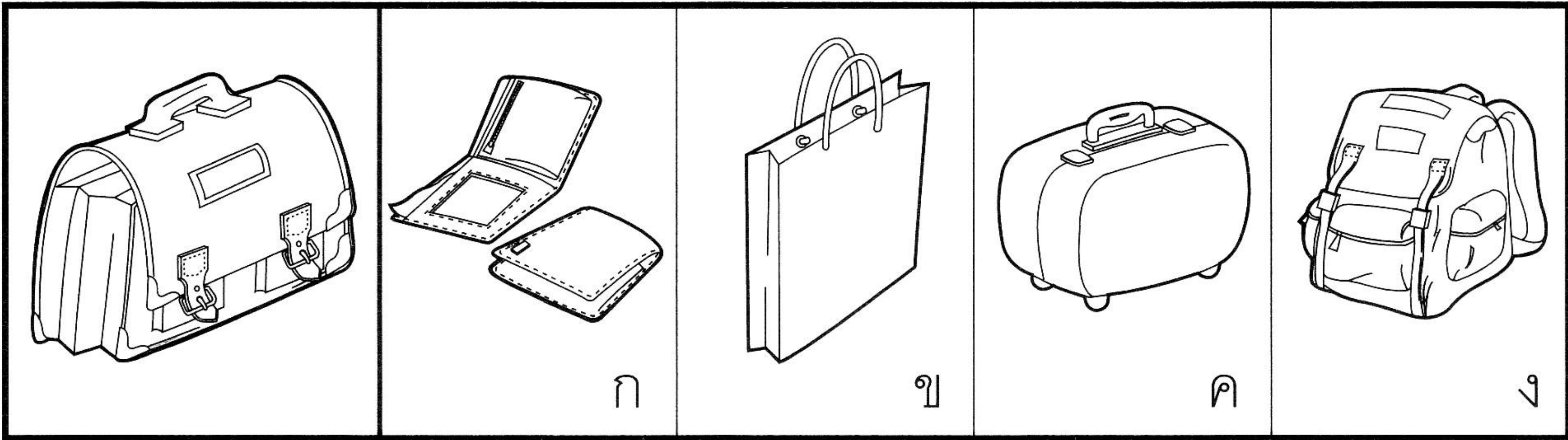

13

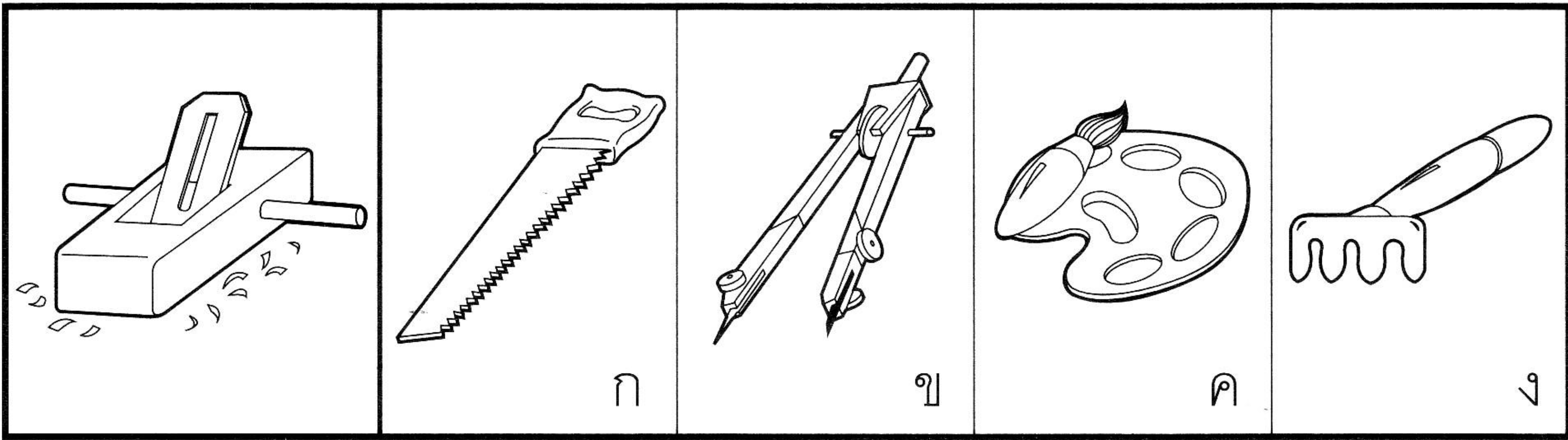

14

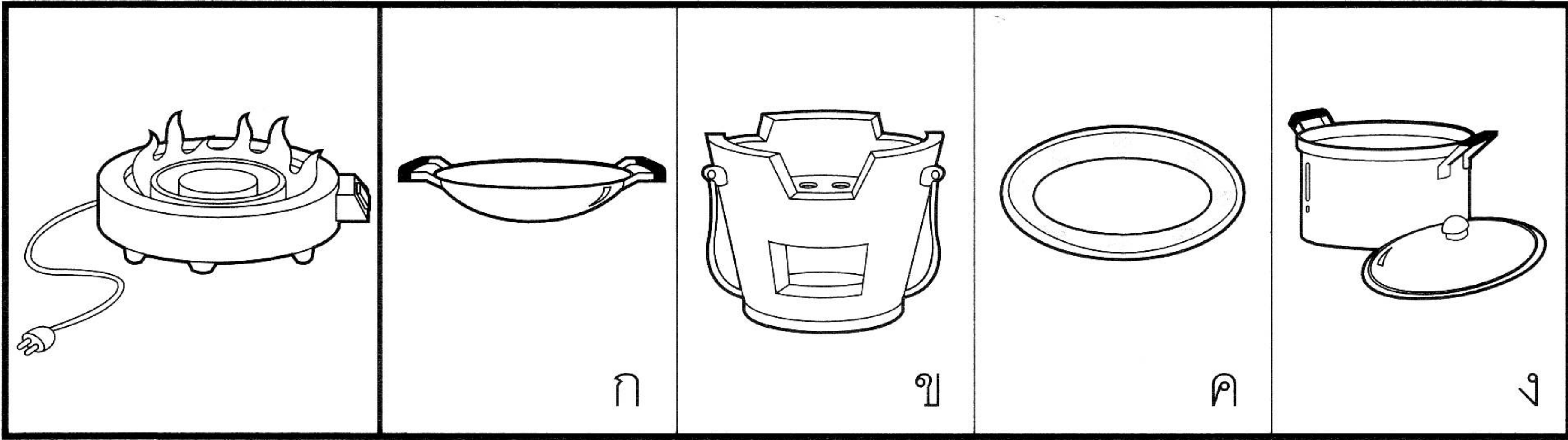

15

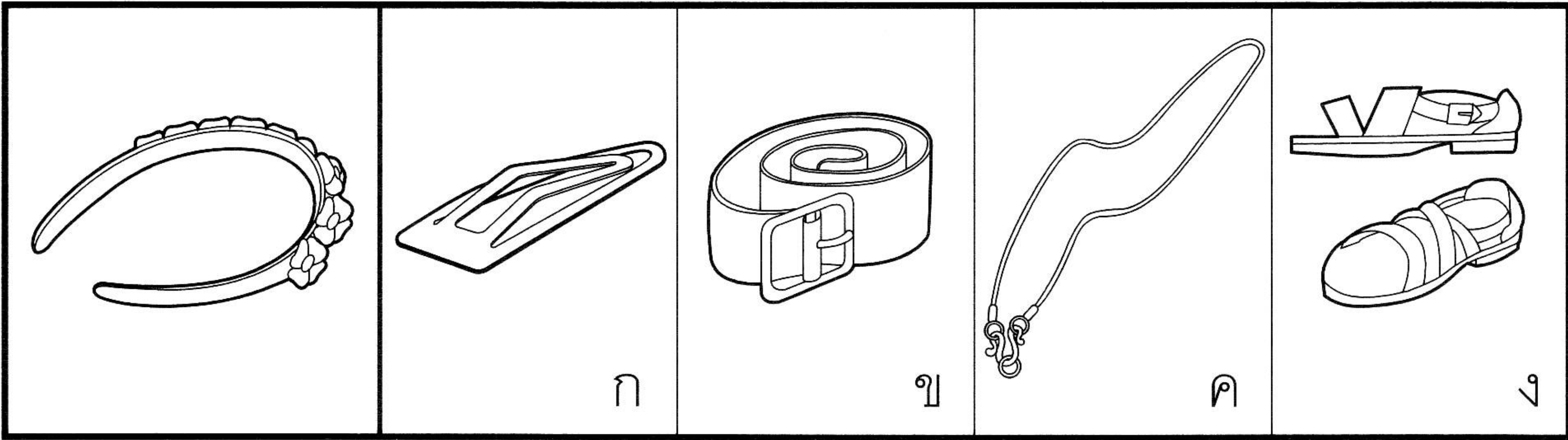

16

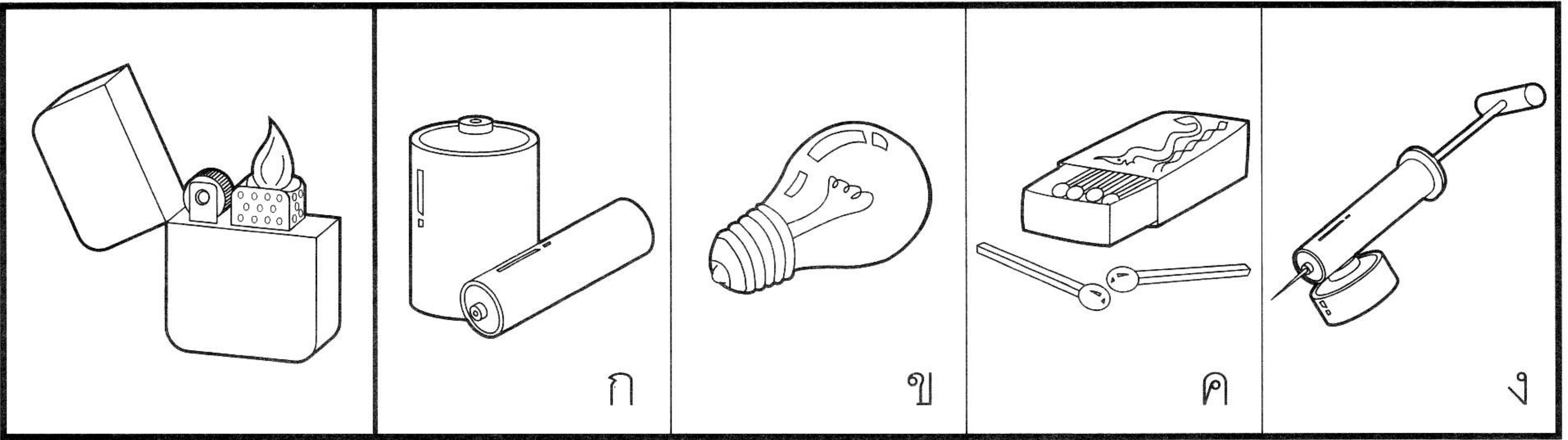

17

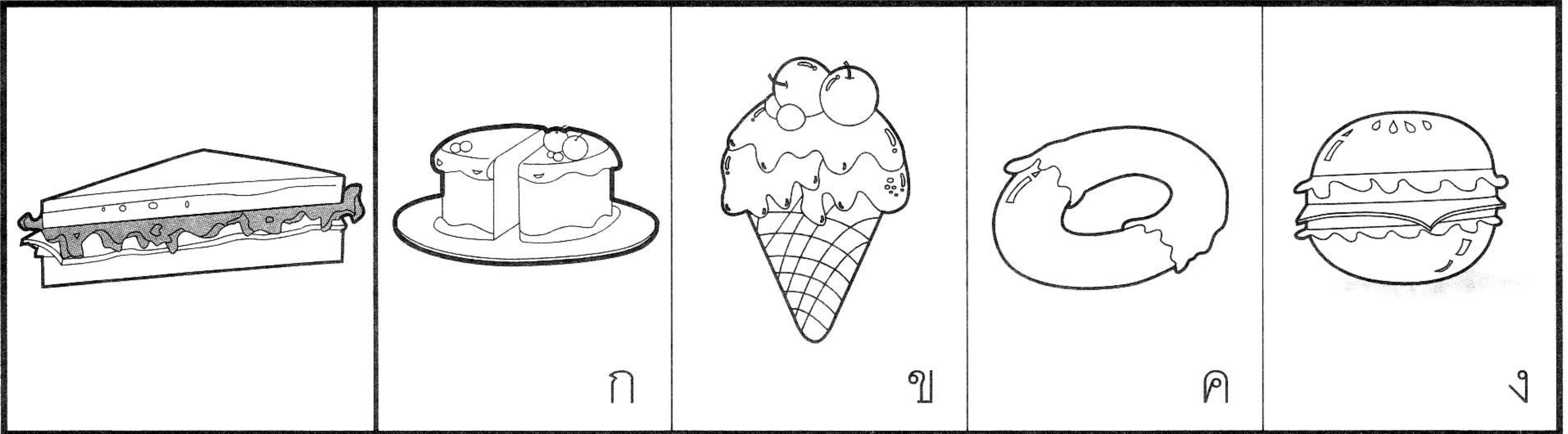

18

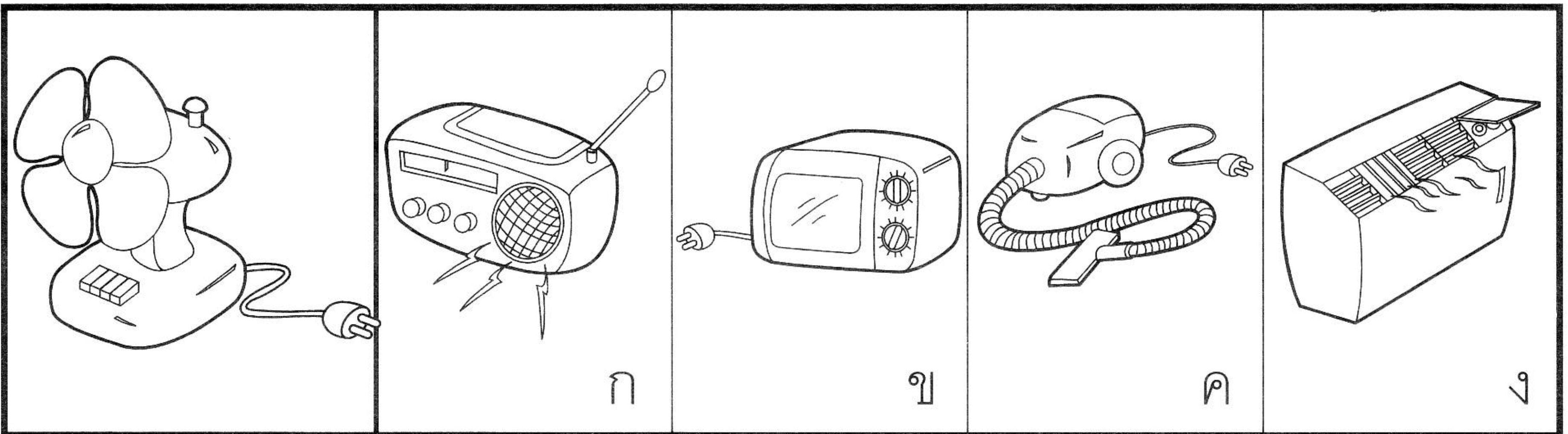

19

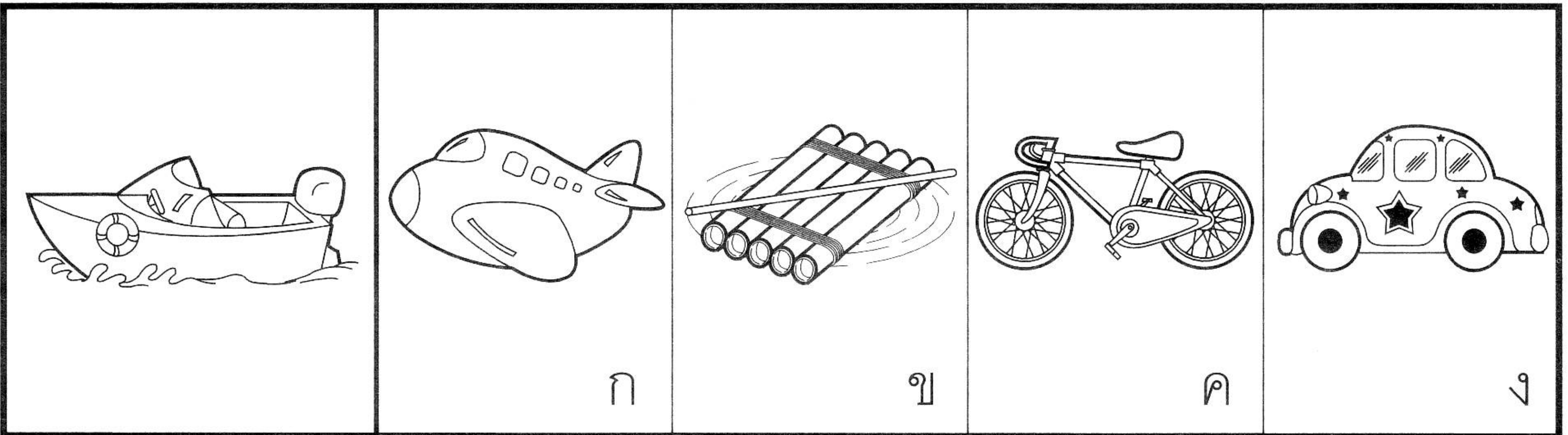

20

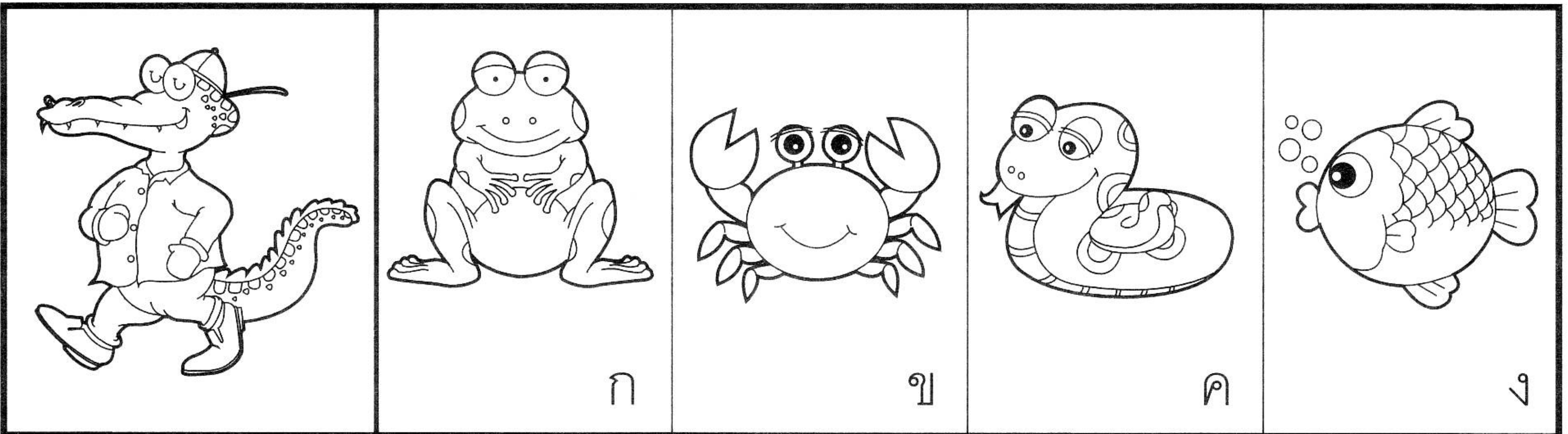

จงขีด ✕ ภาพที่มีคุณสมบัติเหมือนสิ่งที่กำหนดให้ในช่องแรก

1

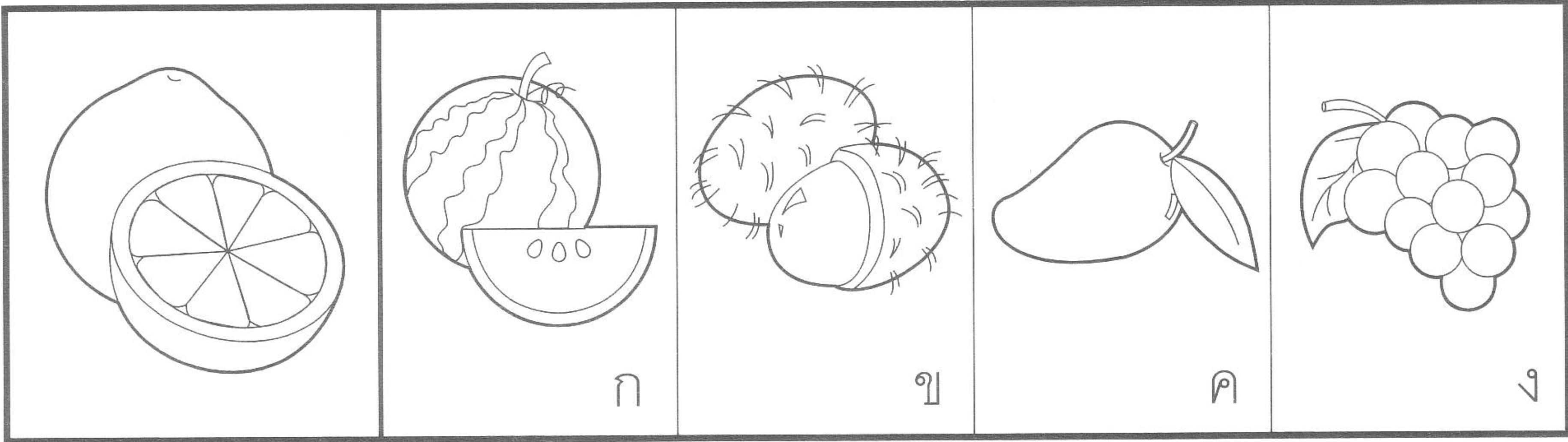

2

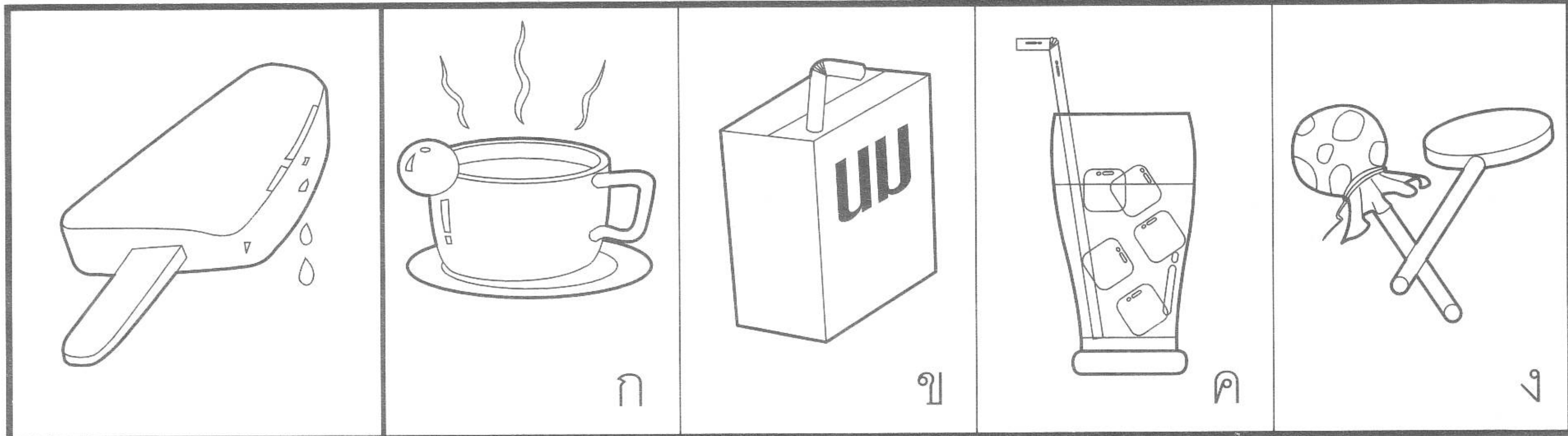

3

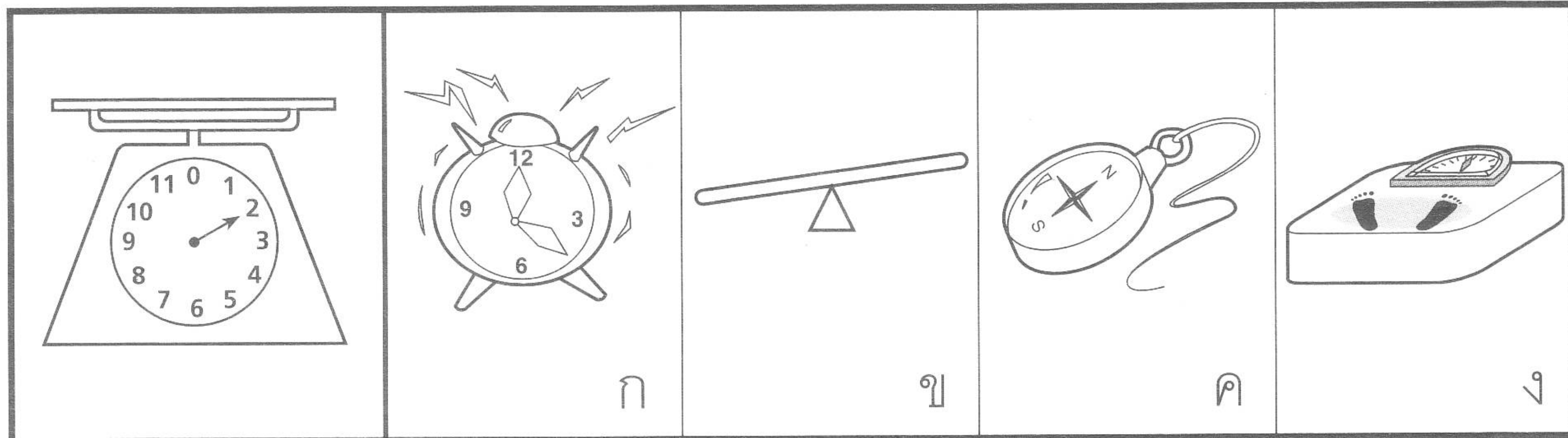

4

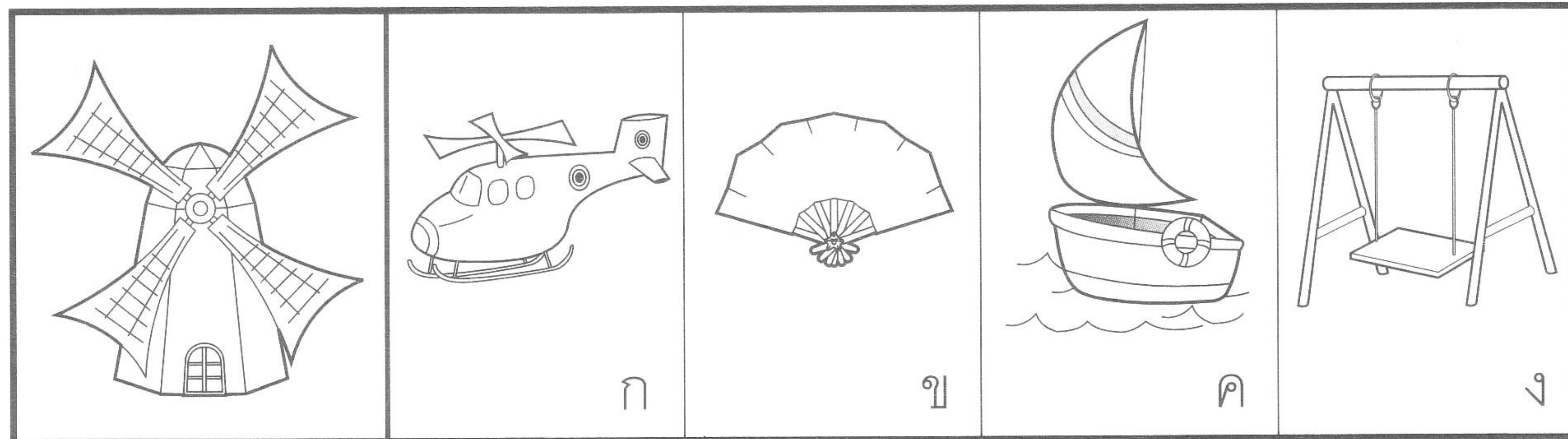

5

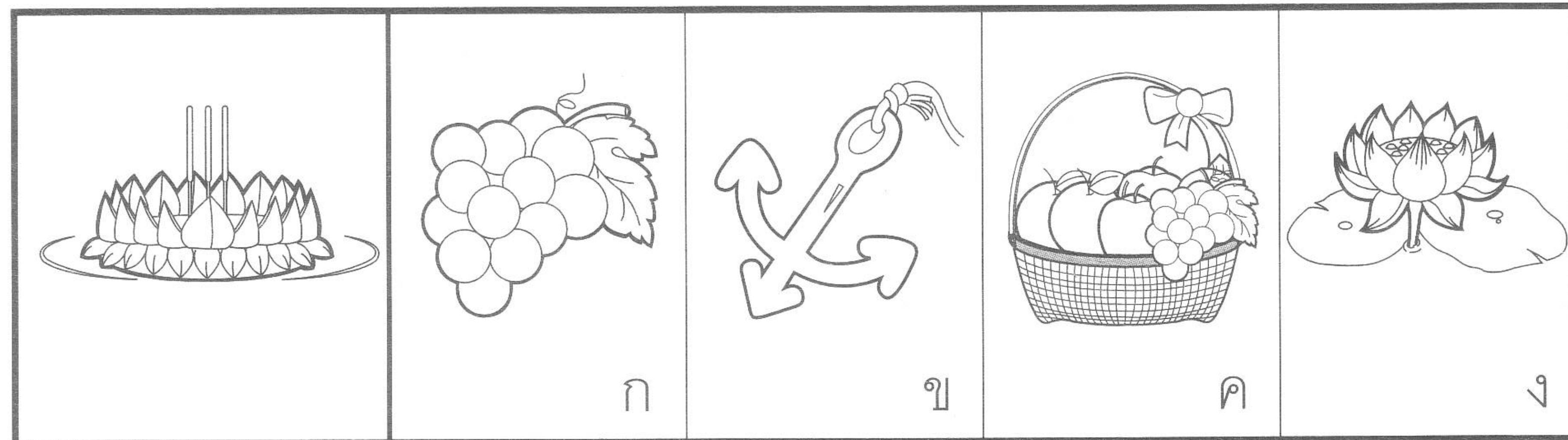

6

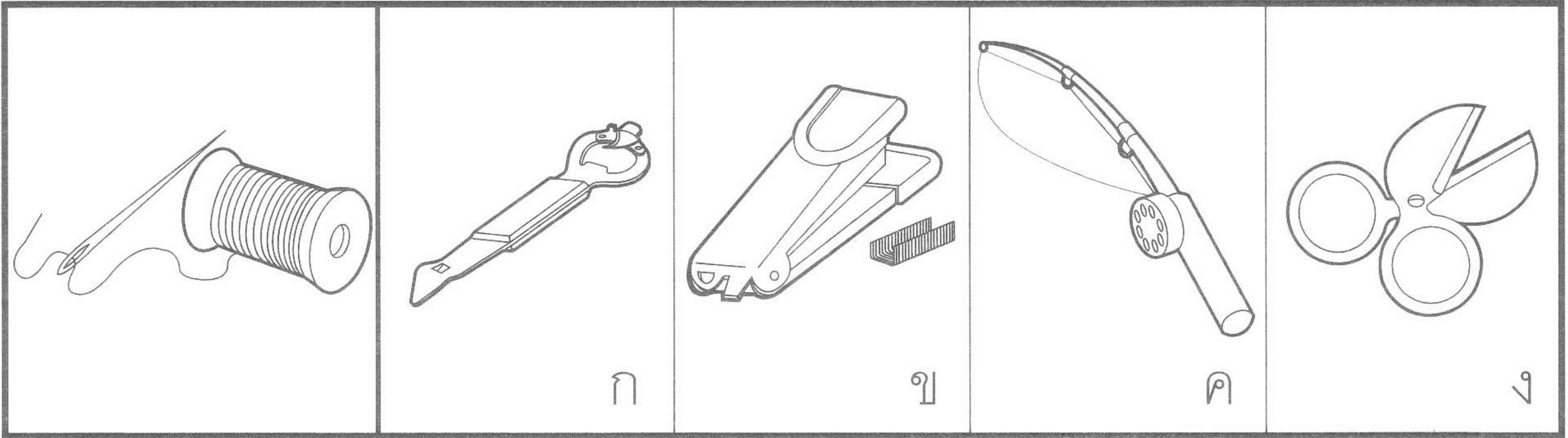

7

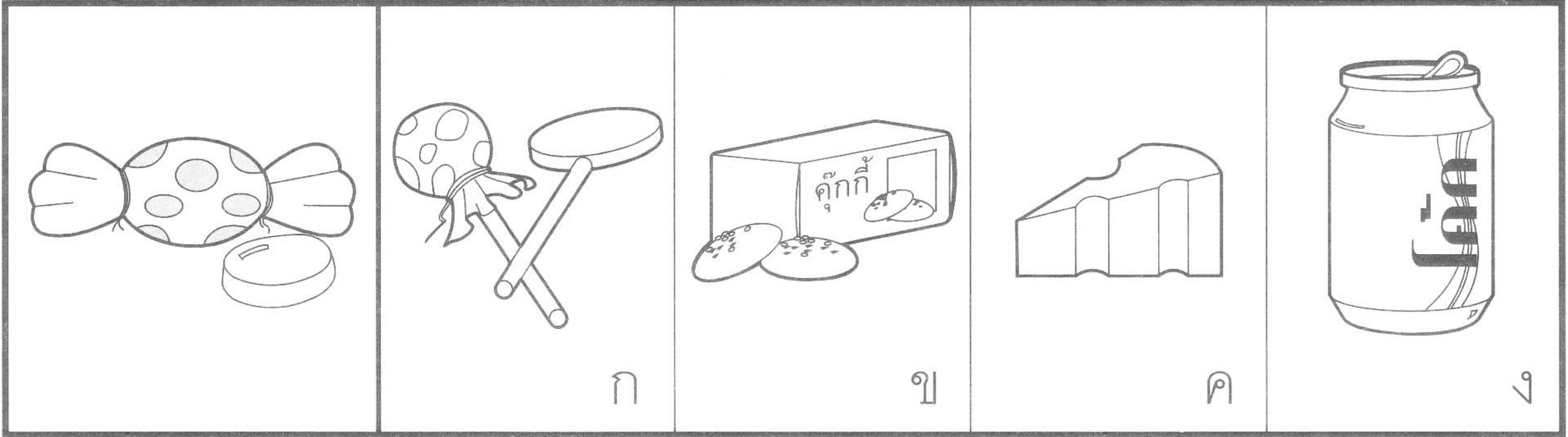

8

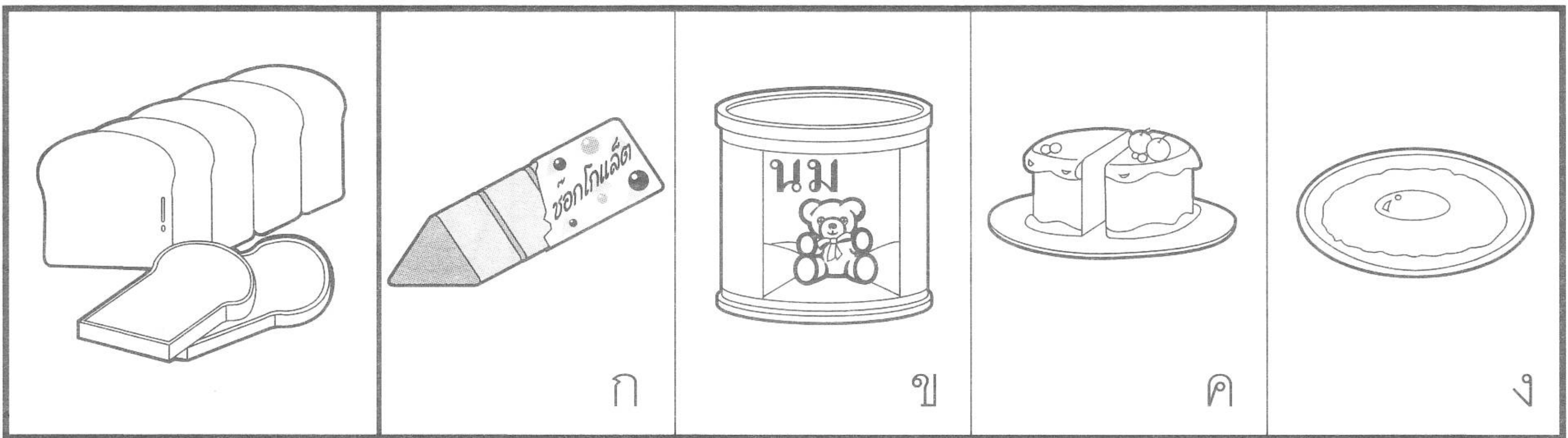

9

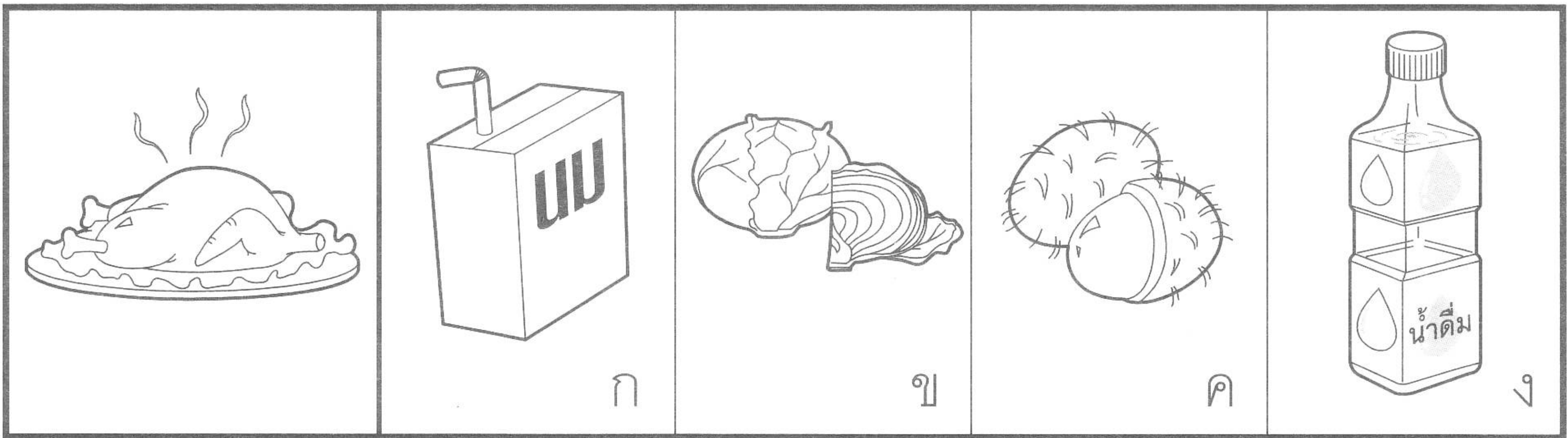

10

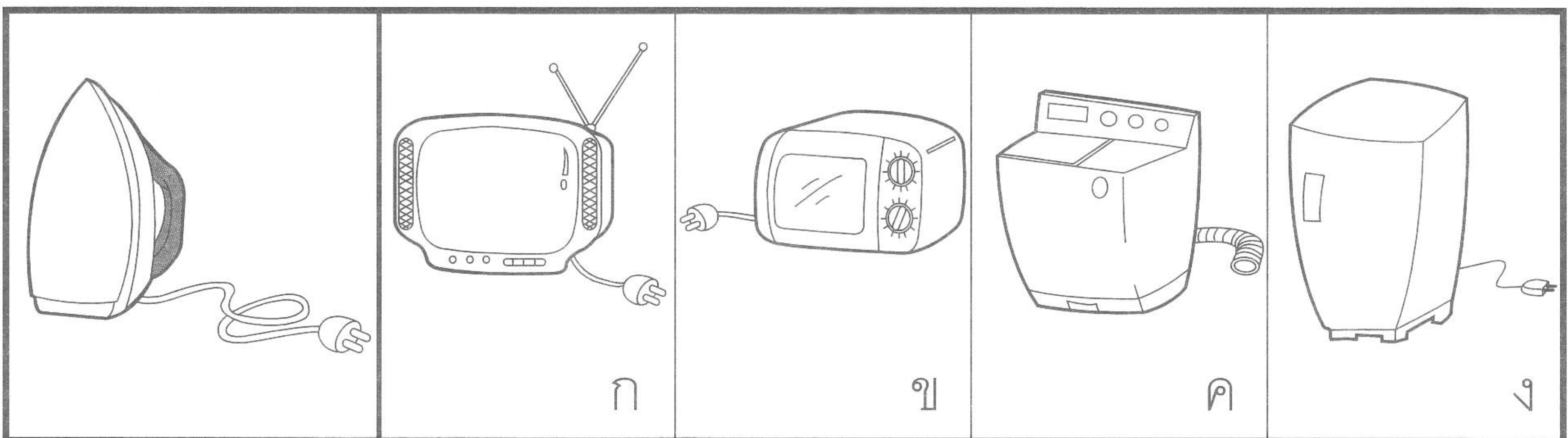

11

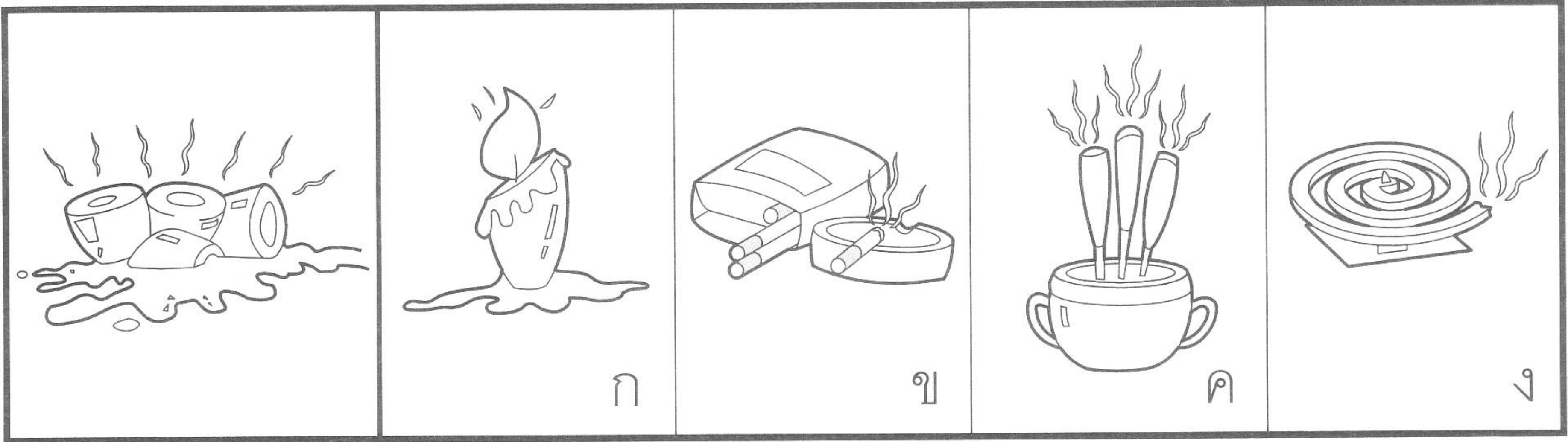

12

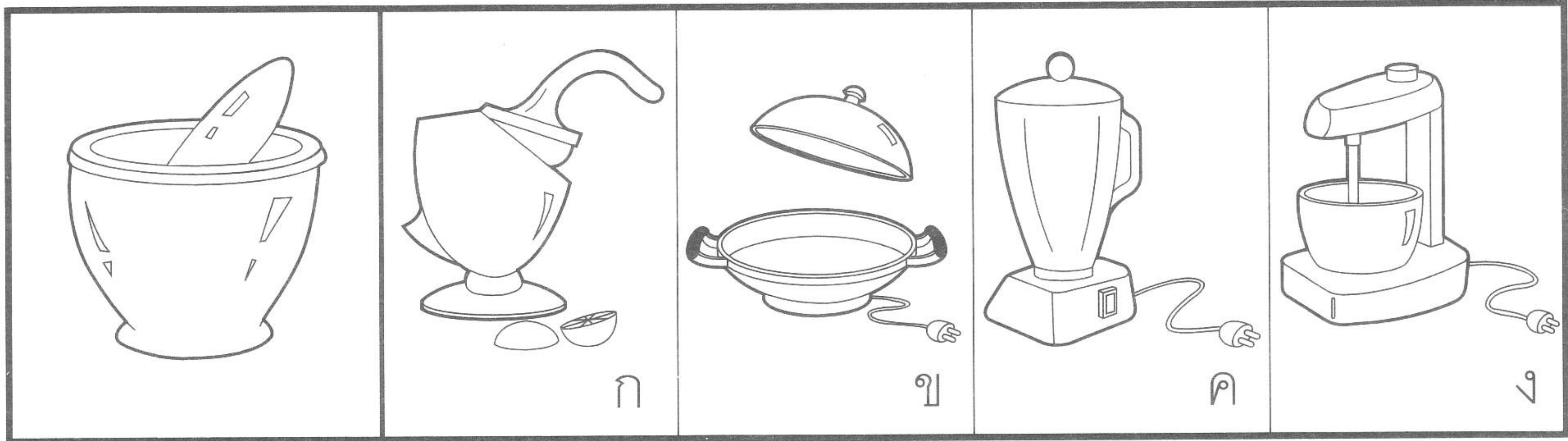

13

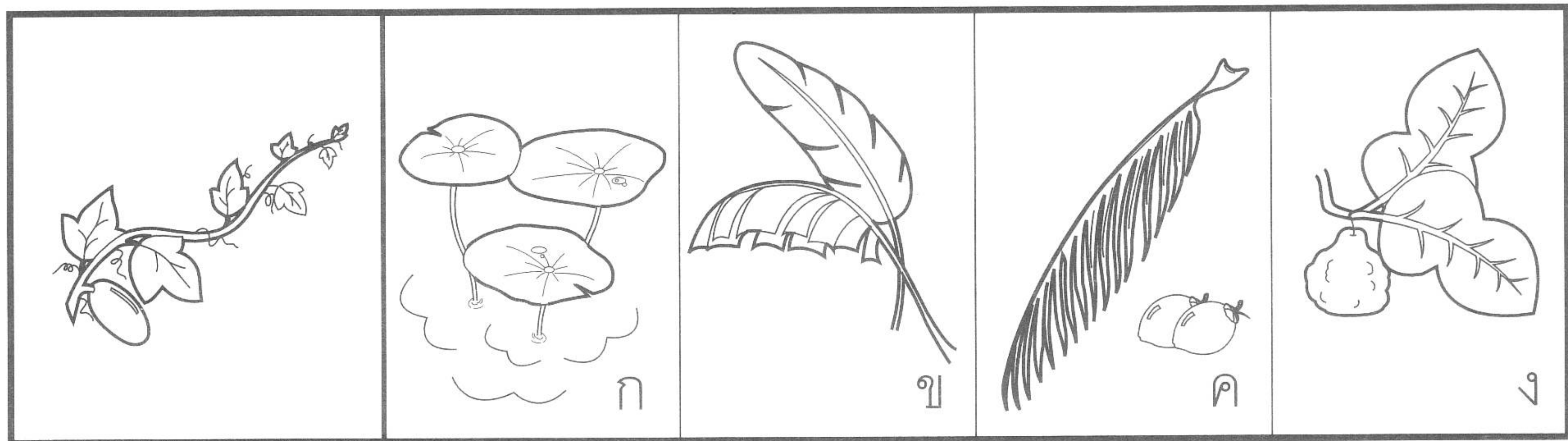

14

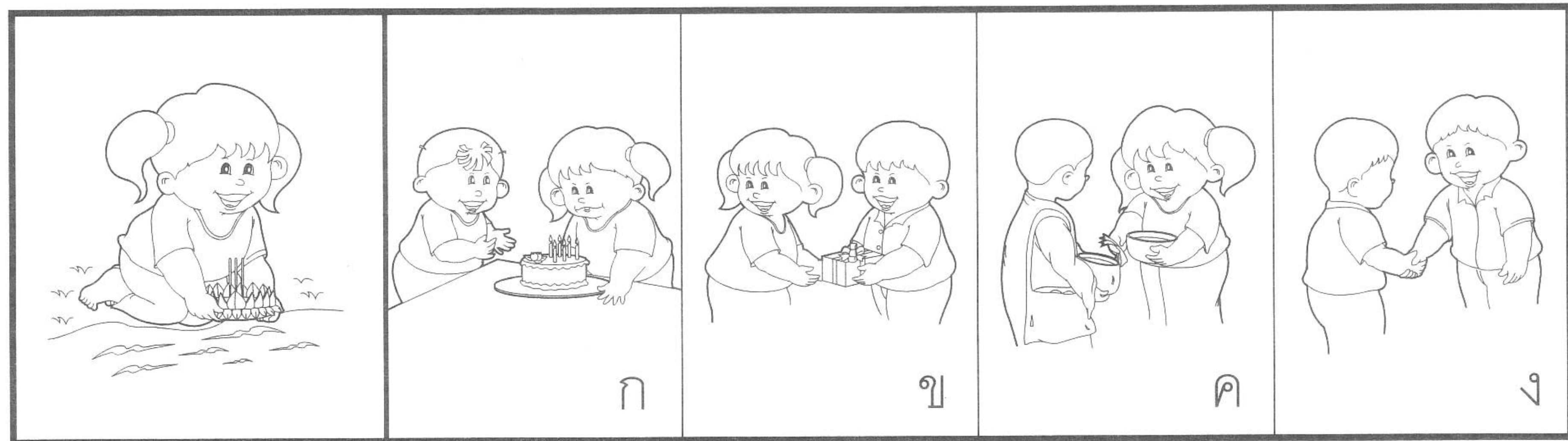

15

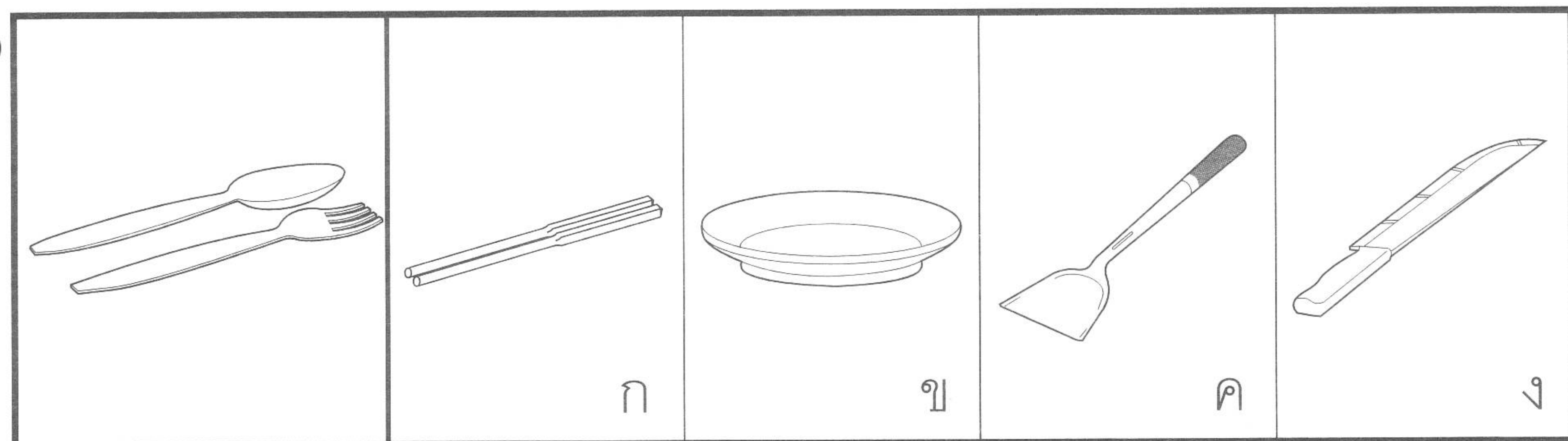

16

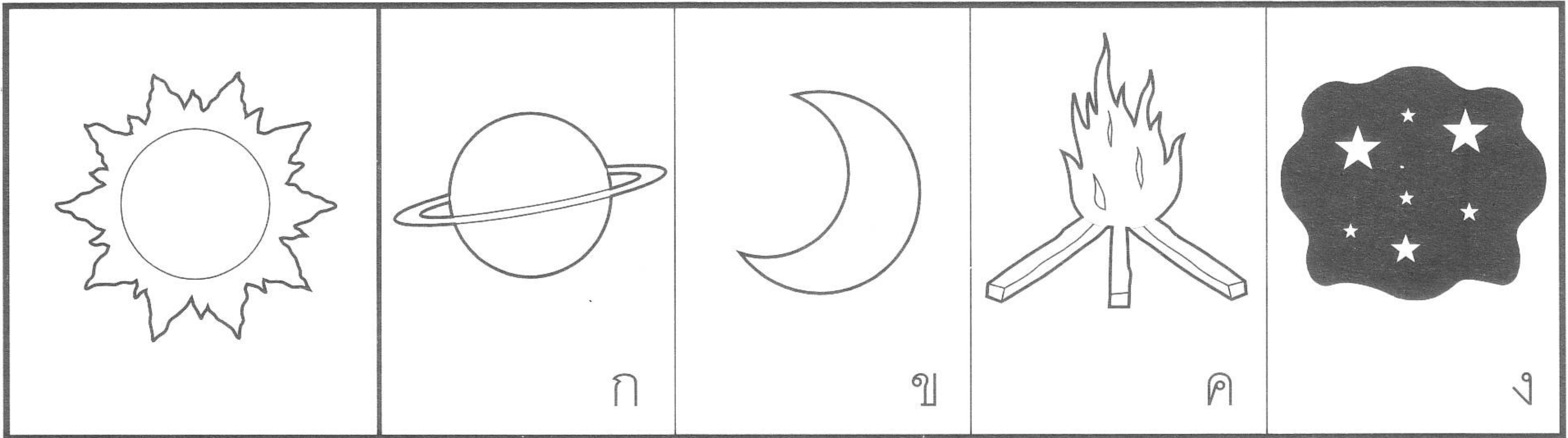

17

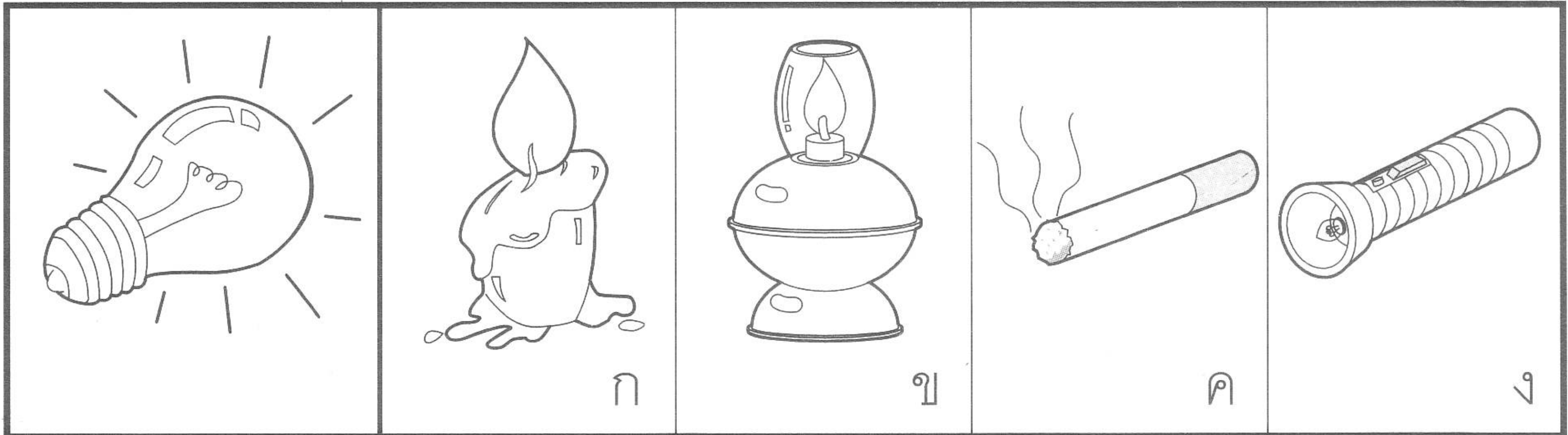

18

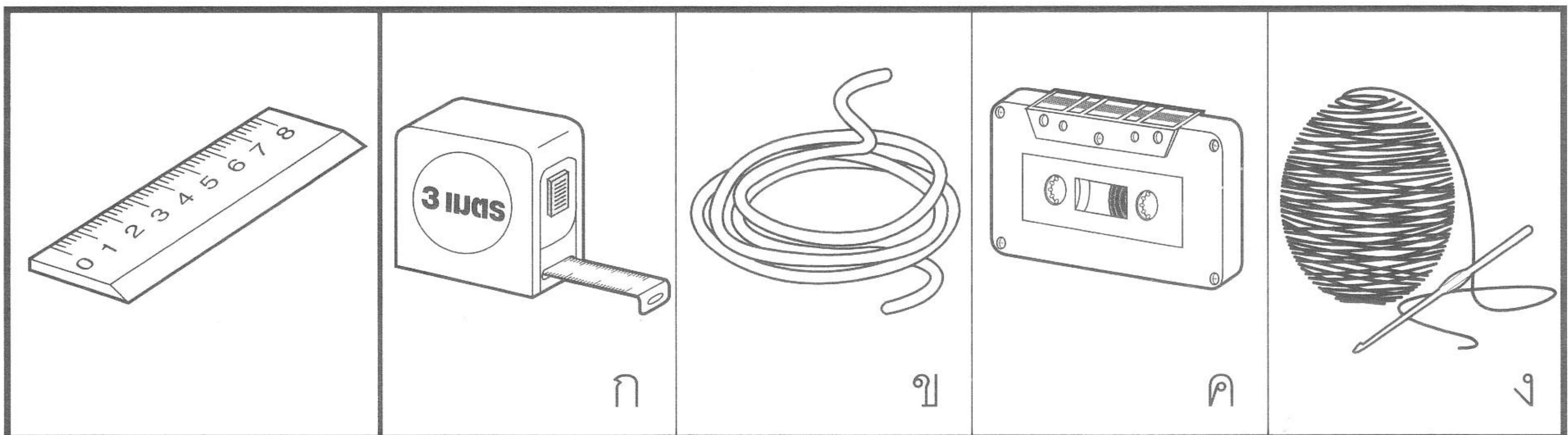

19

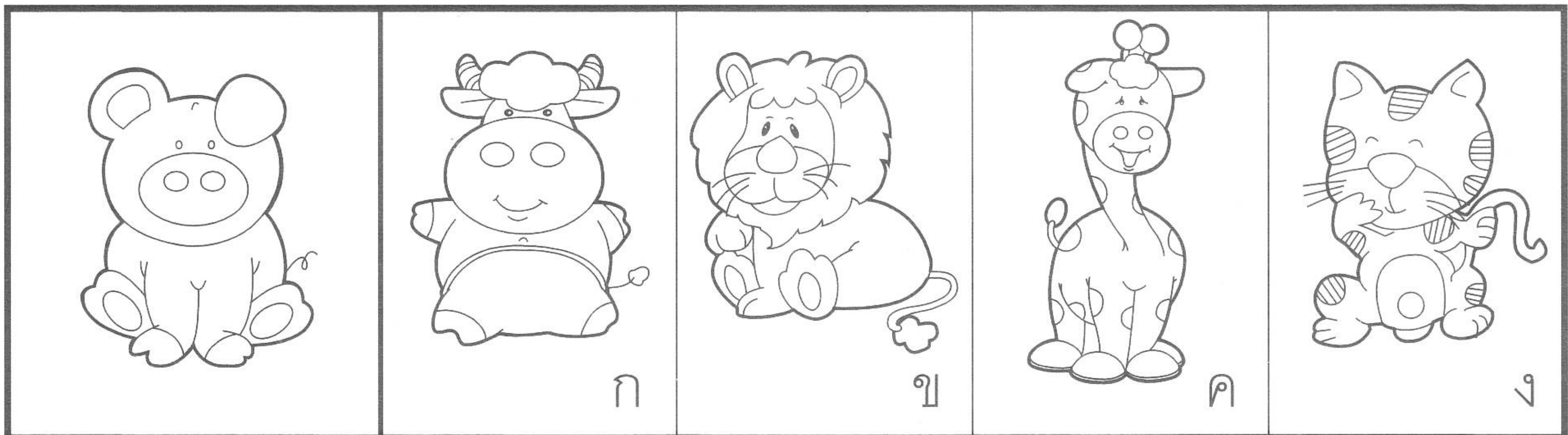

20

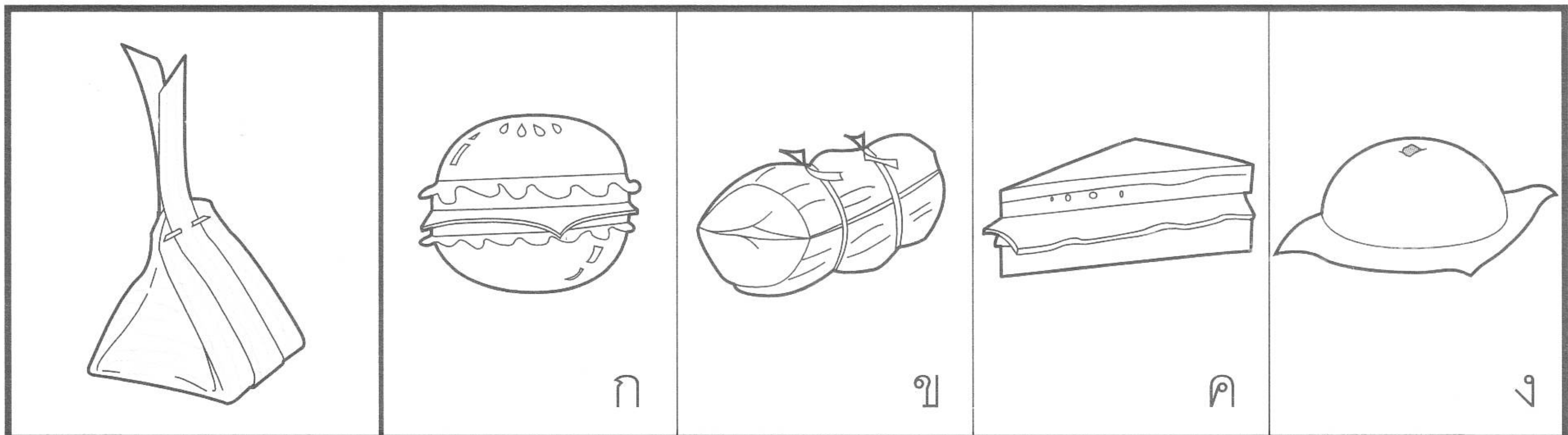

จงขีด ✕ ภาพที่แตกต่างจากภาพอื่น

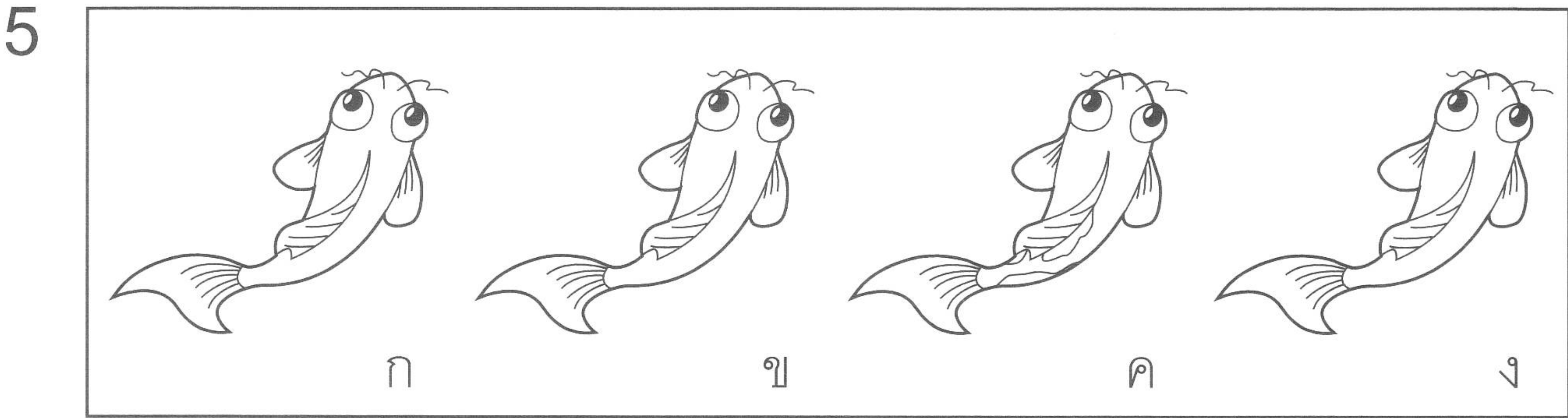
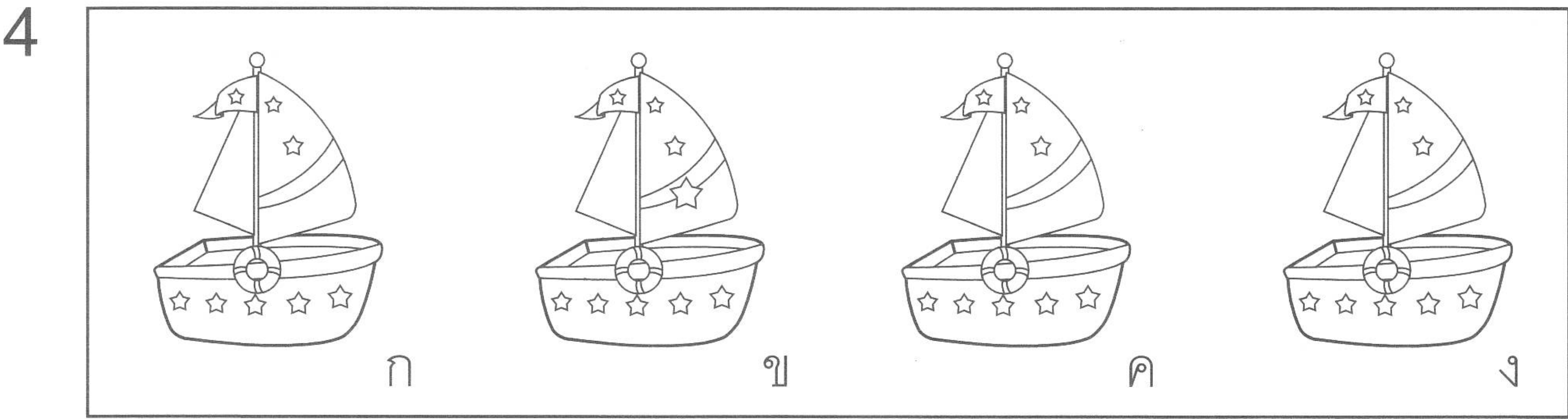
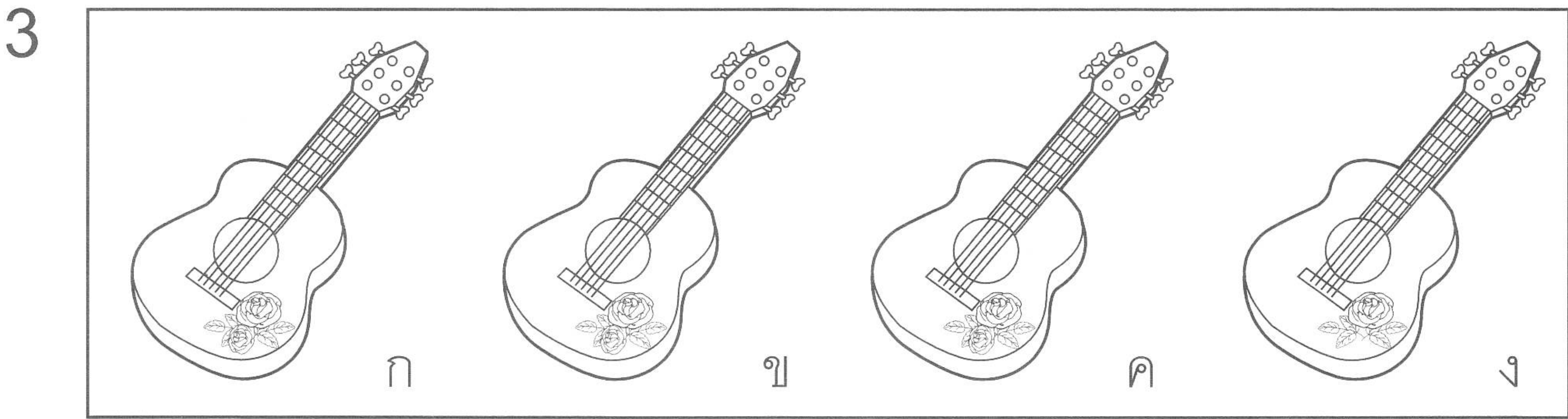
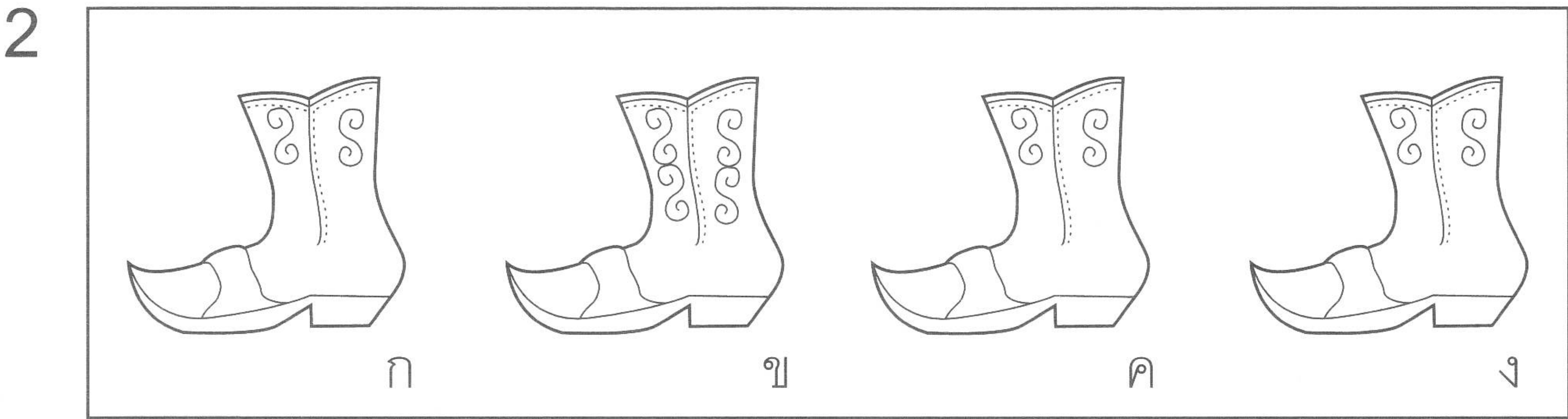
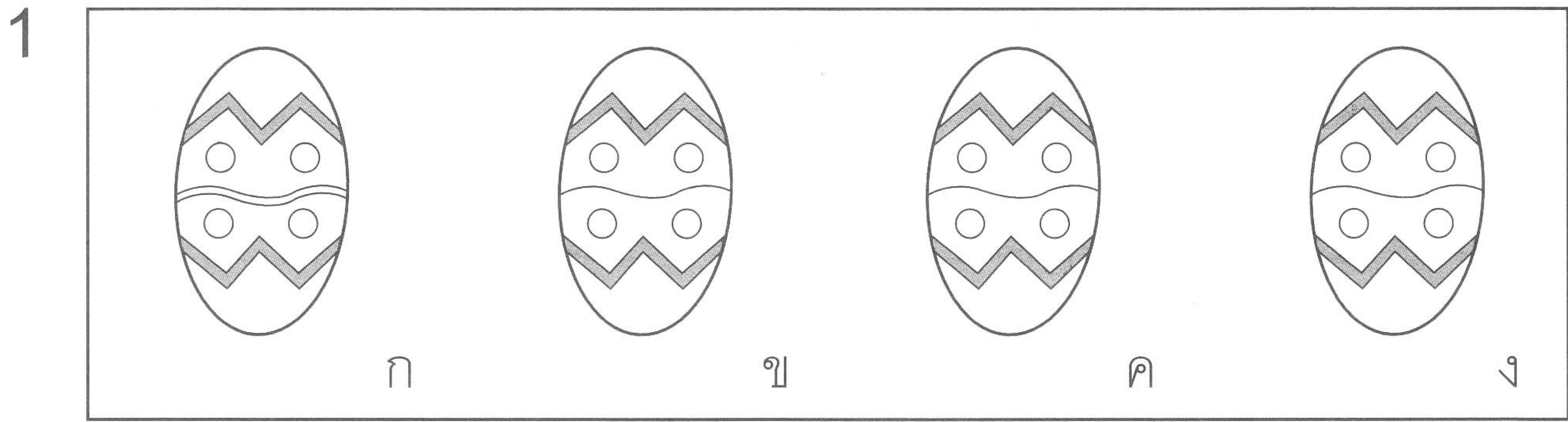

6

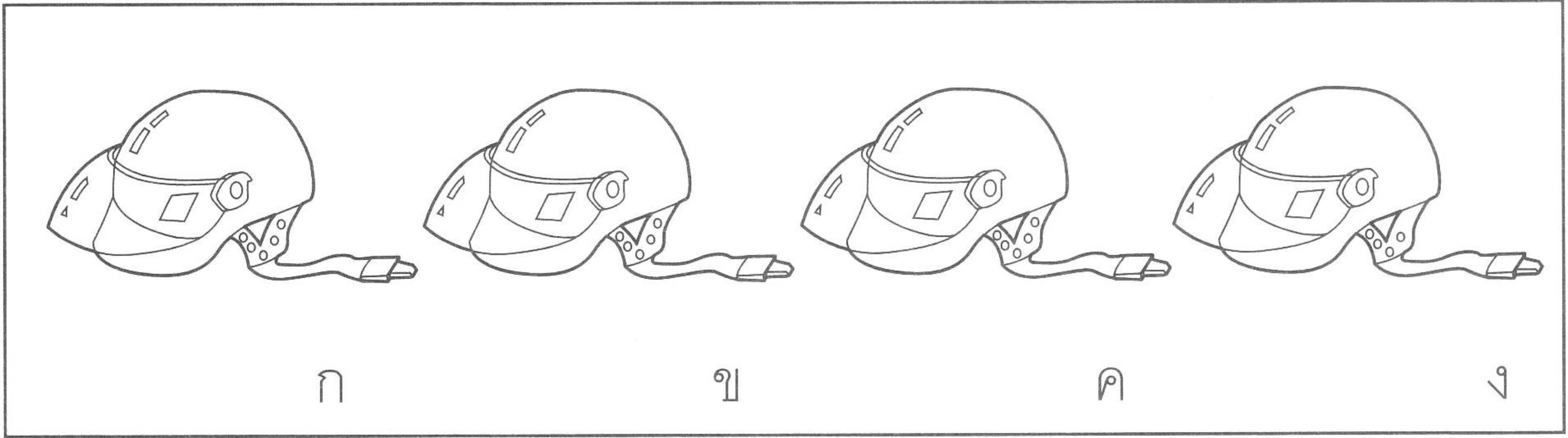

7

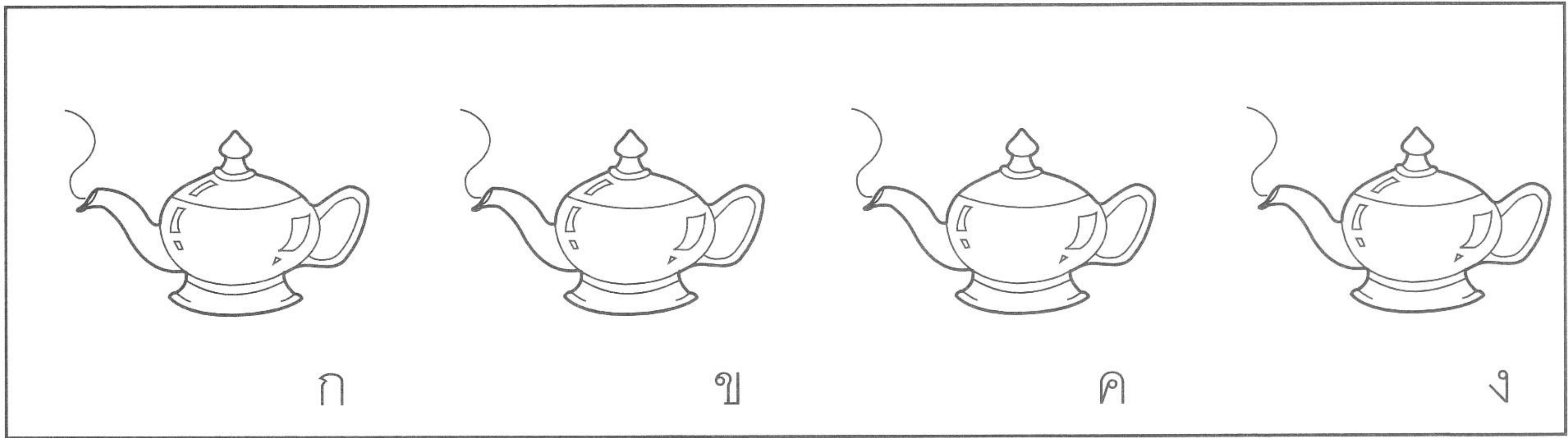

8

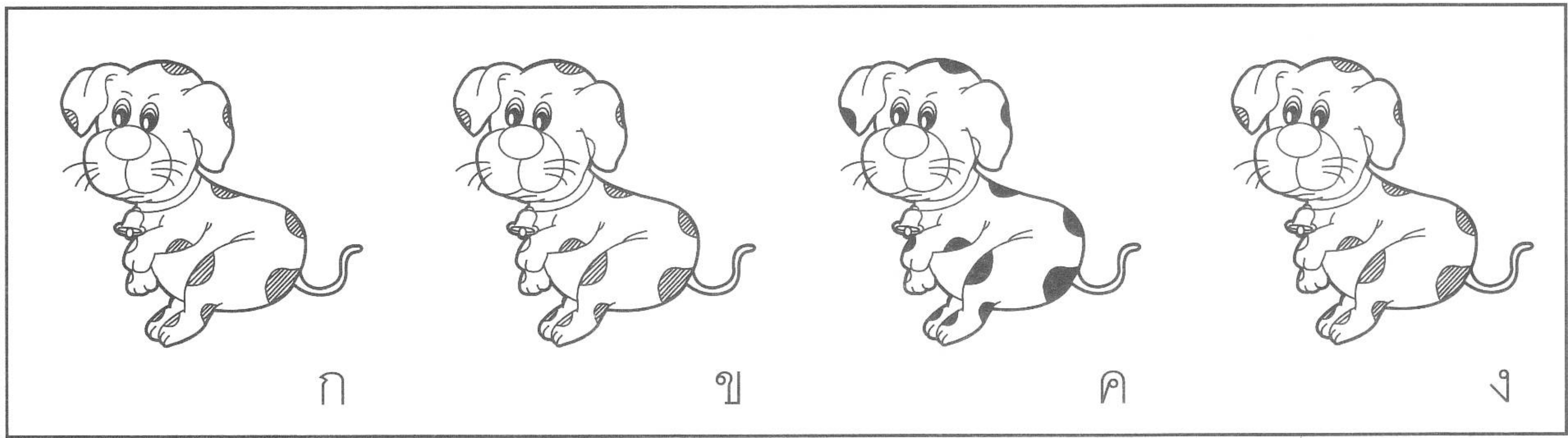

9

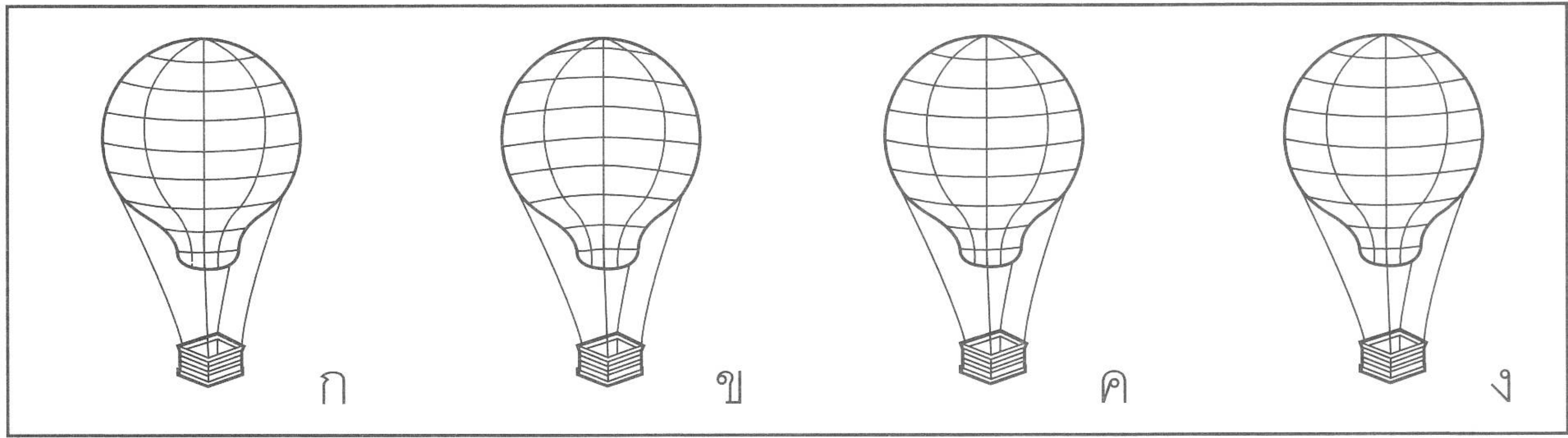

10

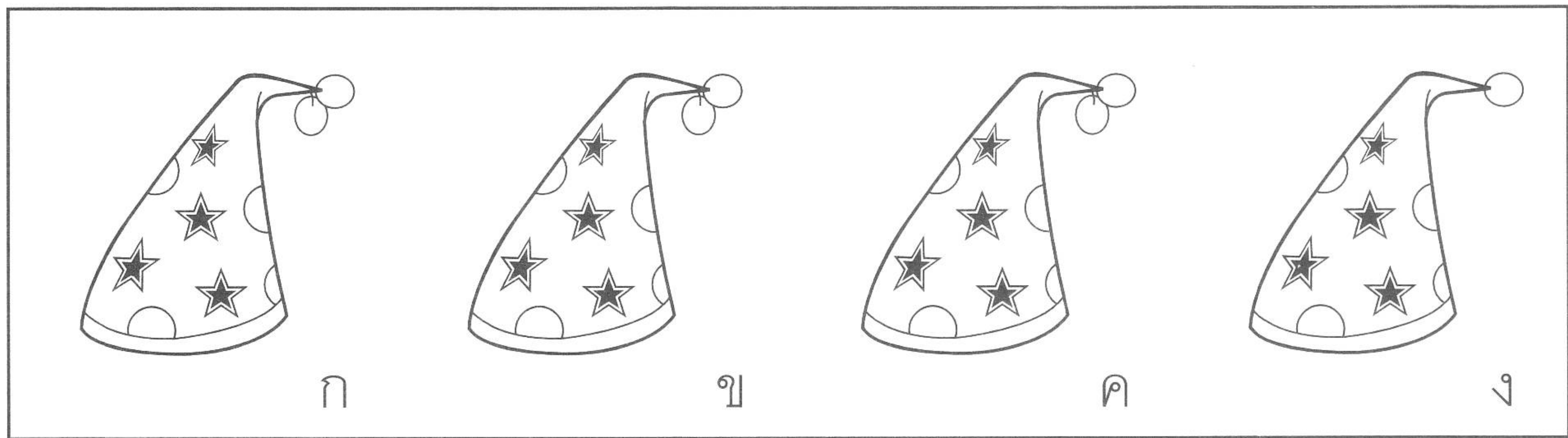

11

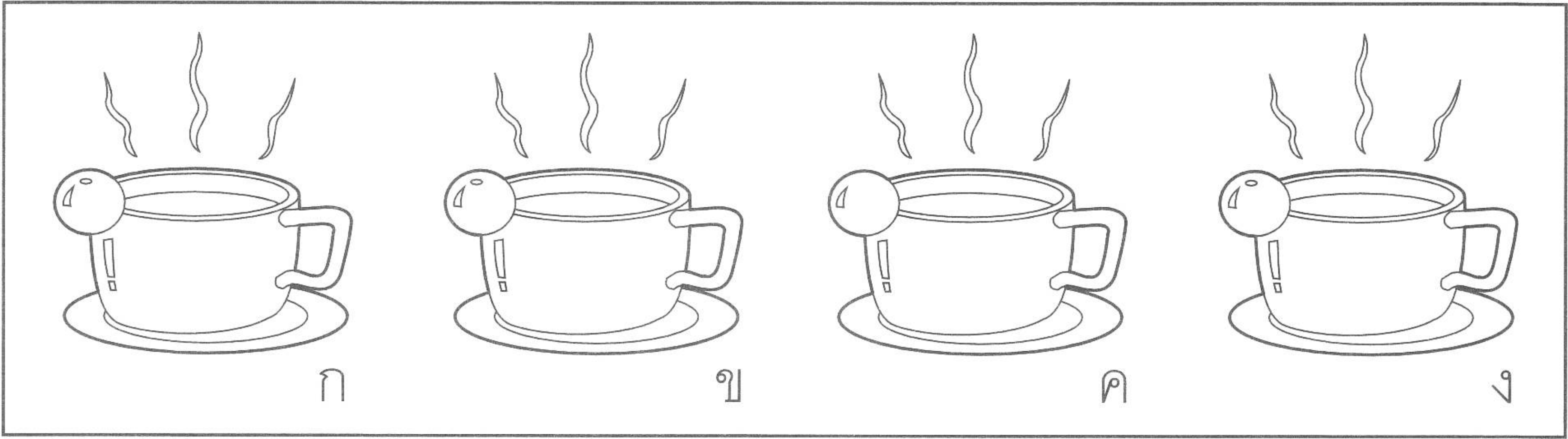

12

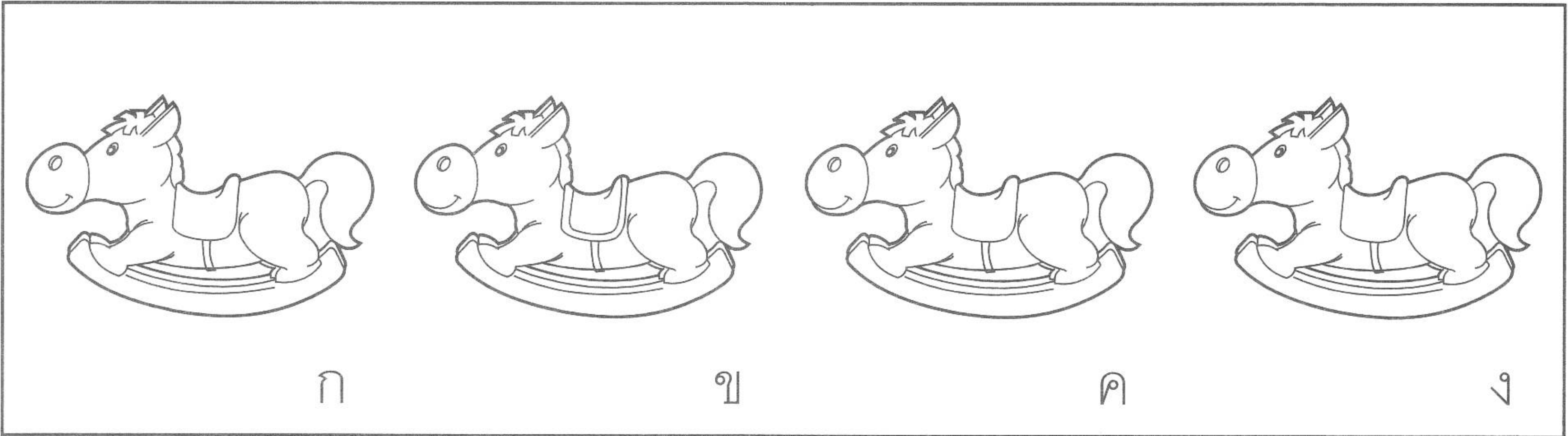

13

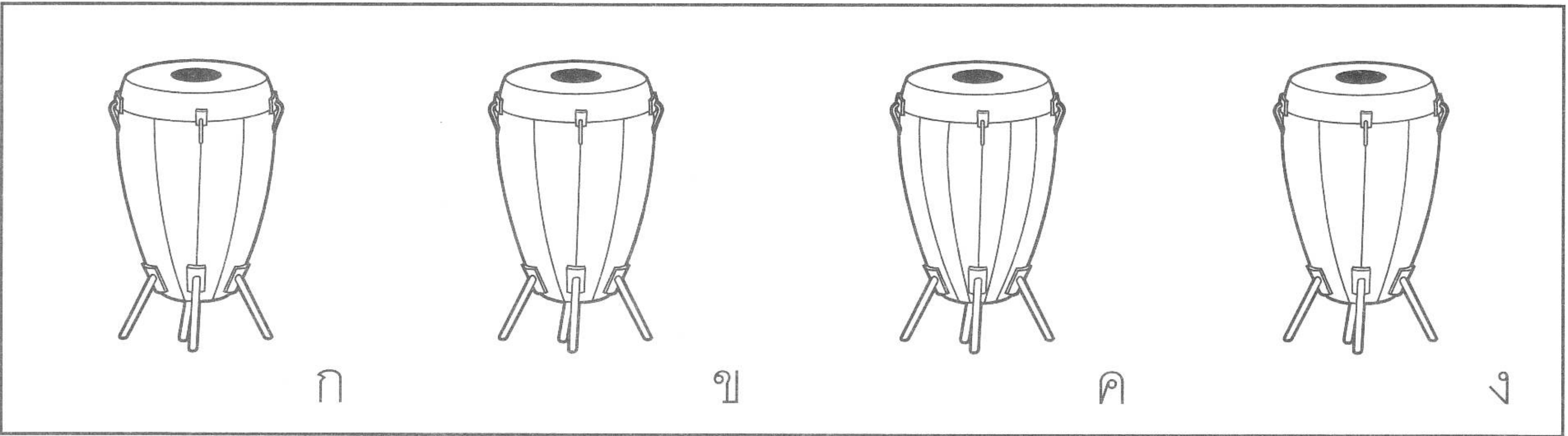

14

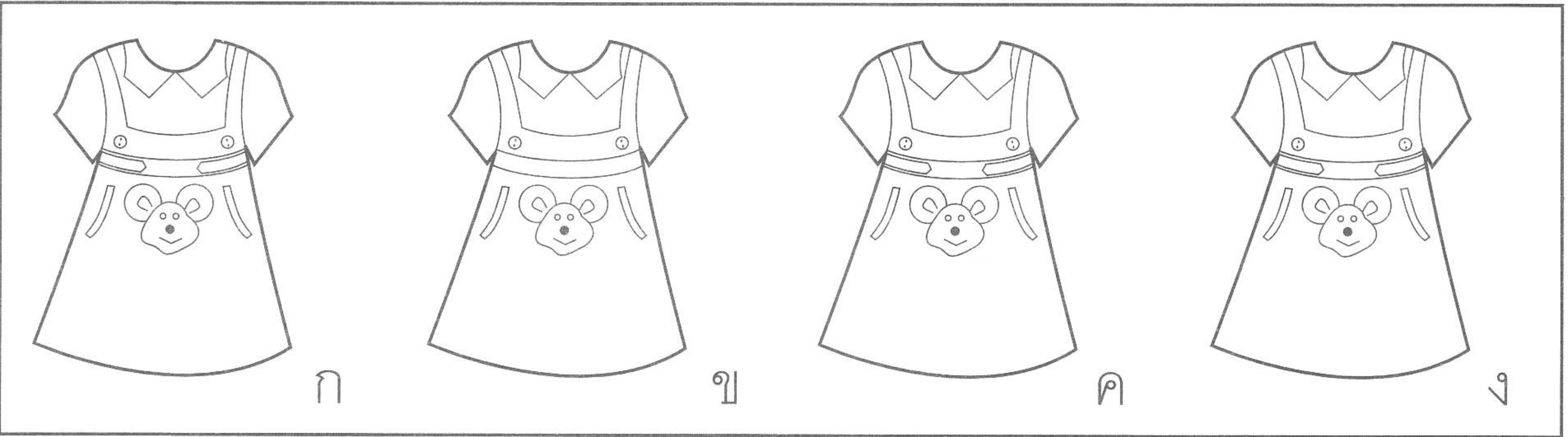

15

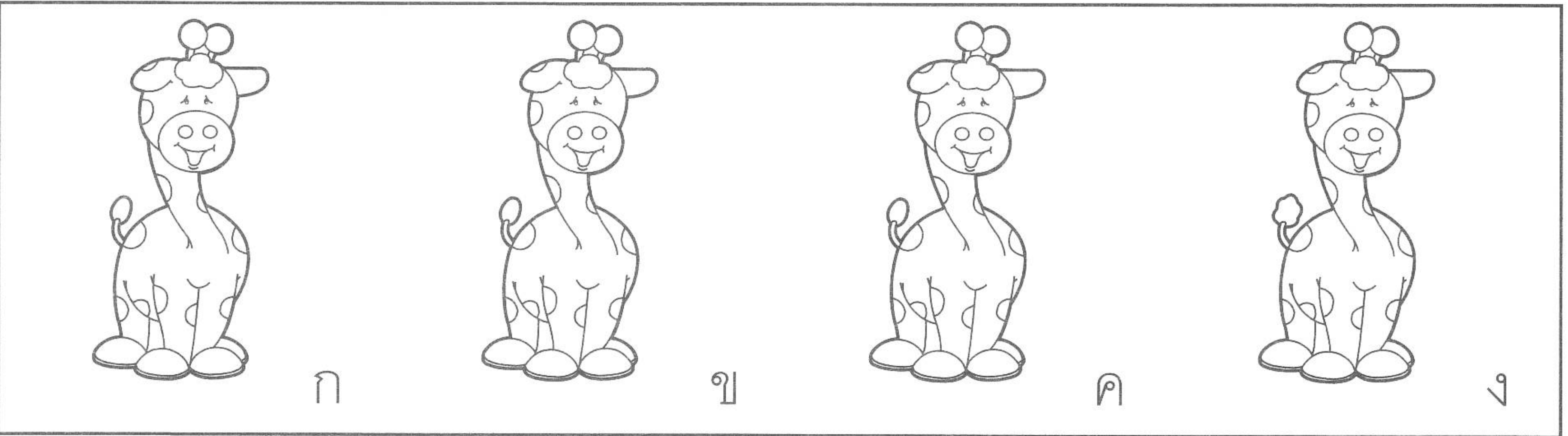

16

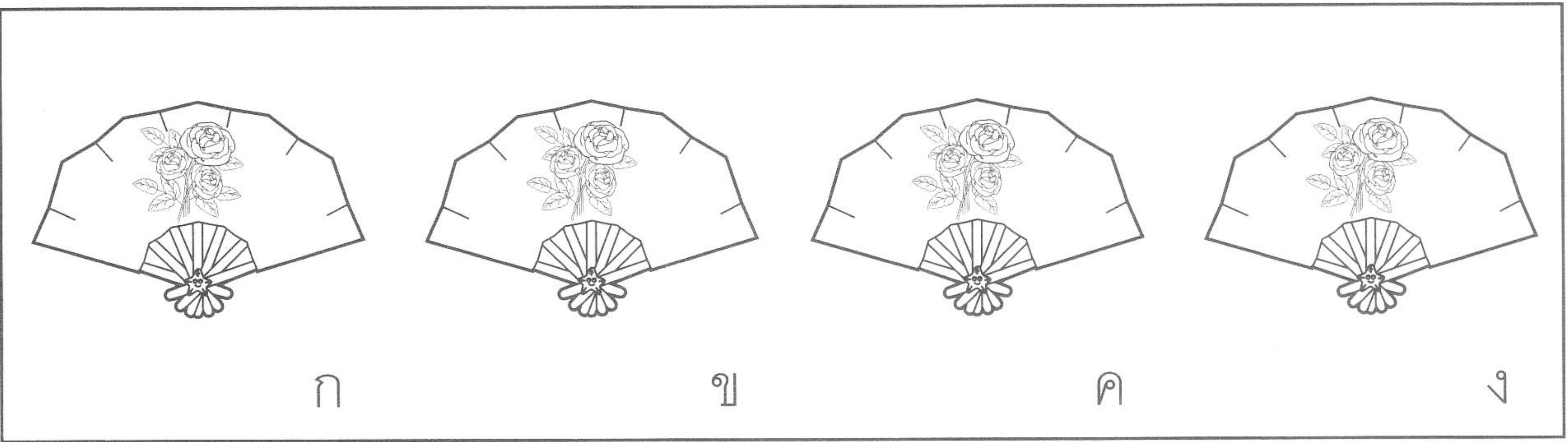

17

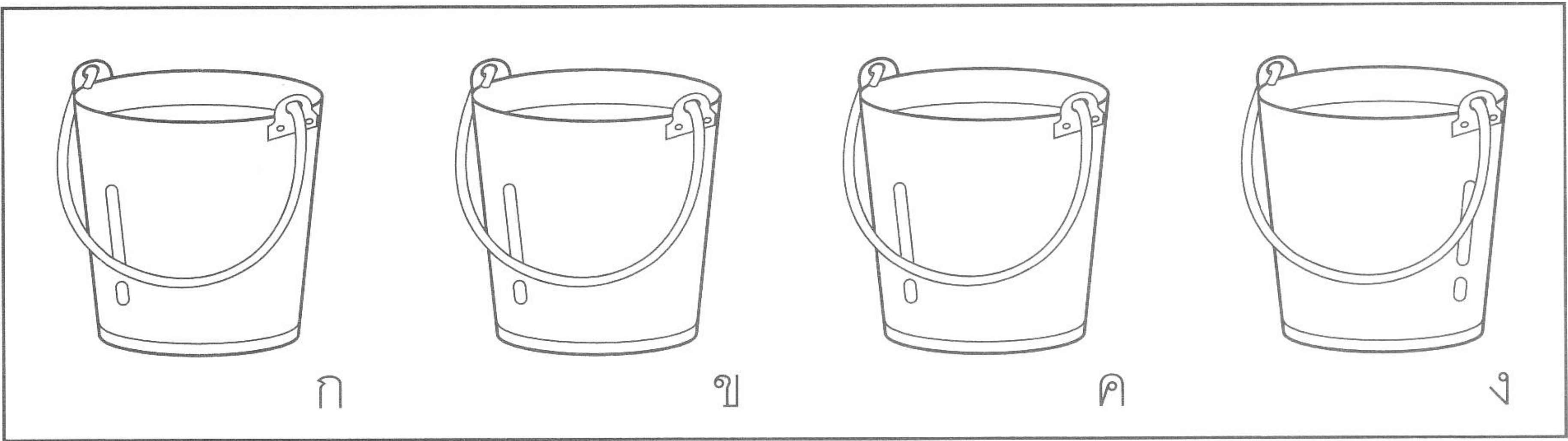

18

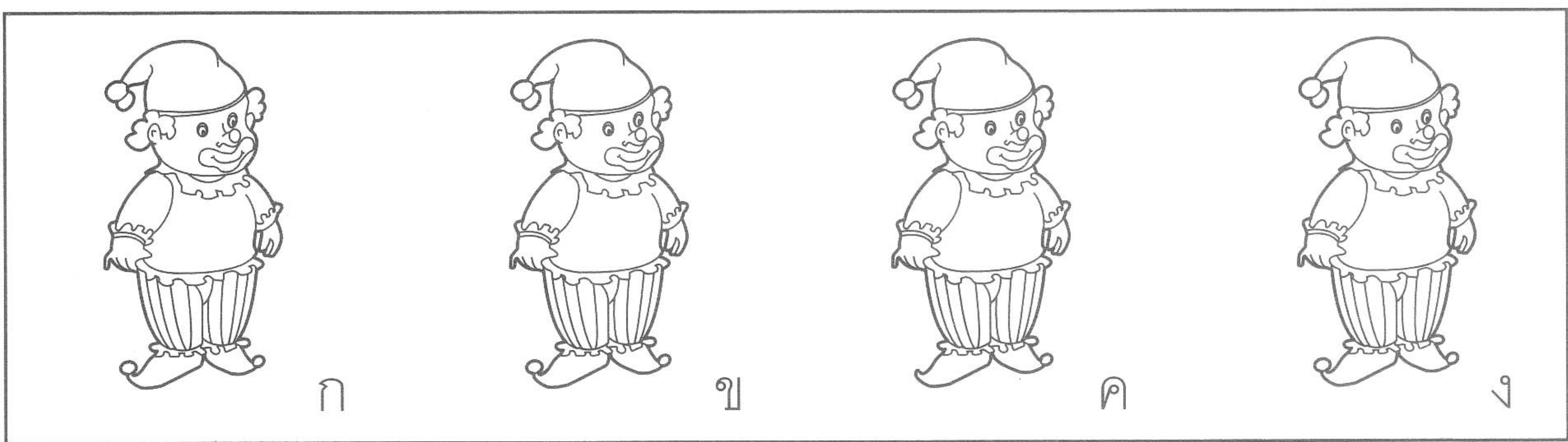

19

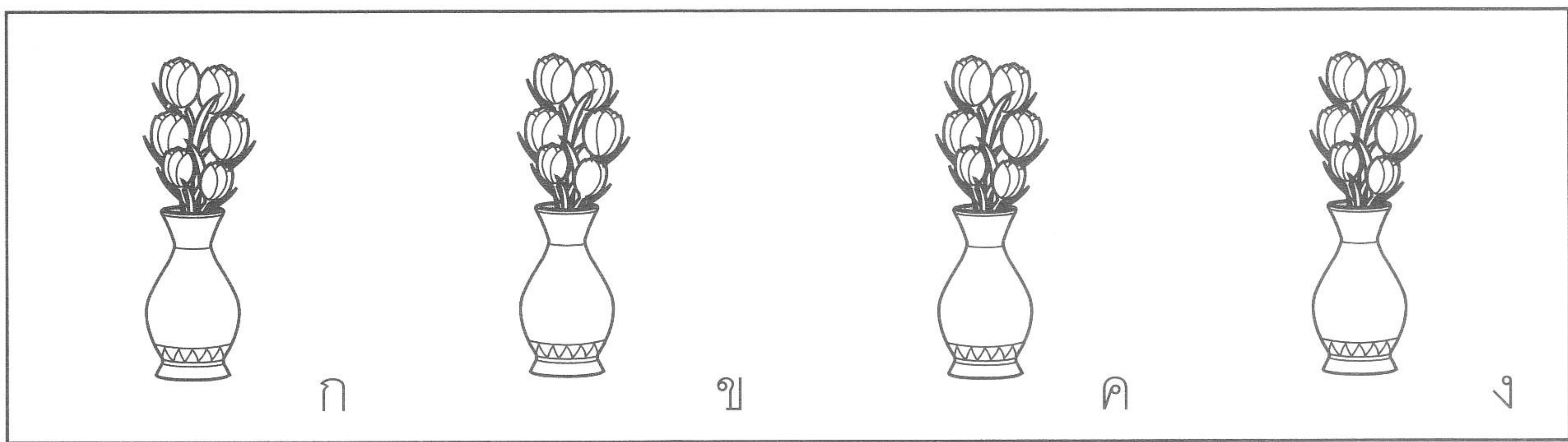

20

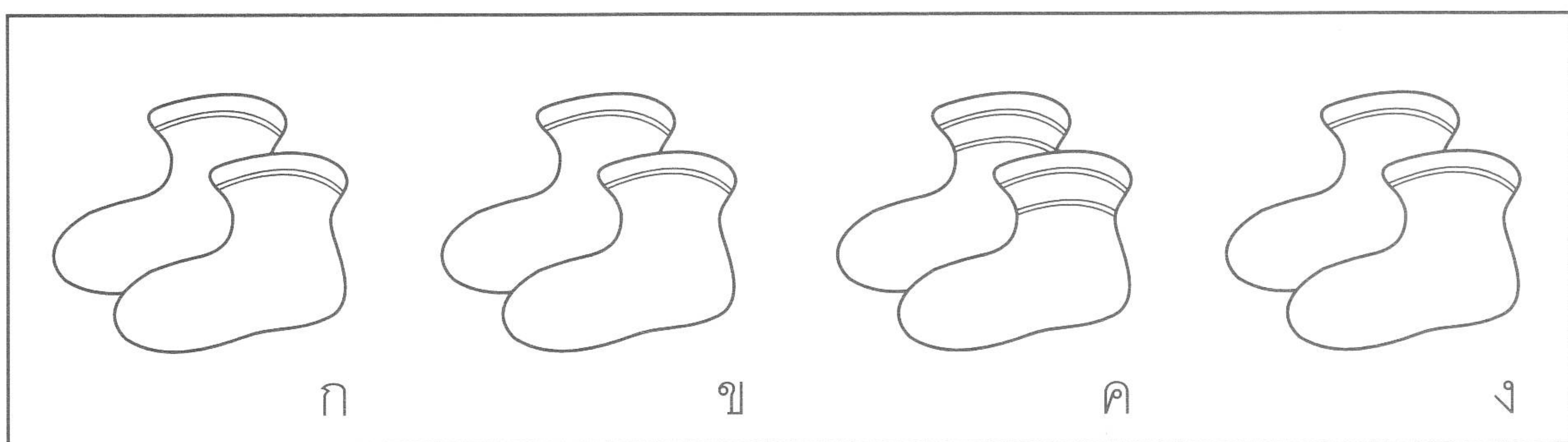

จงขีด ✓ ภาพที่มีคุณสมบัติต่างจากภาพอื่น

1

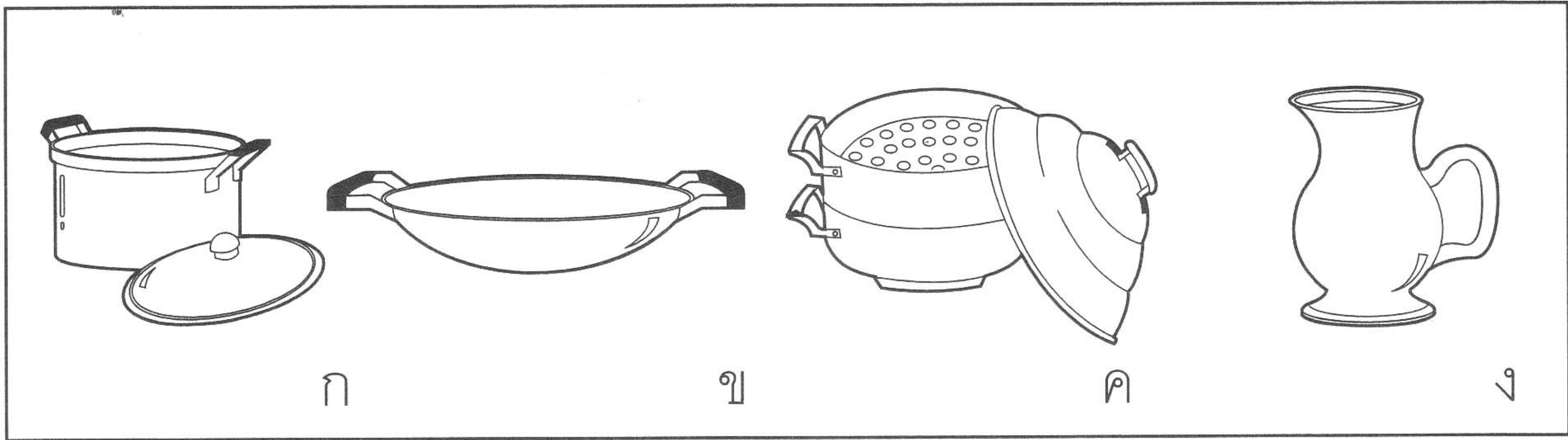

2

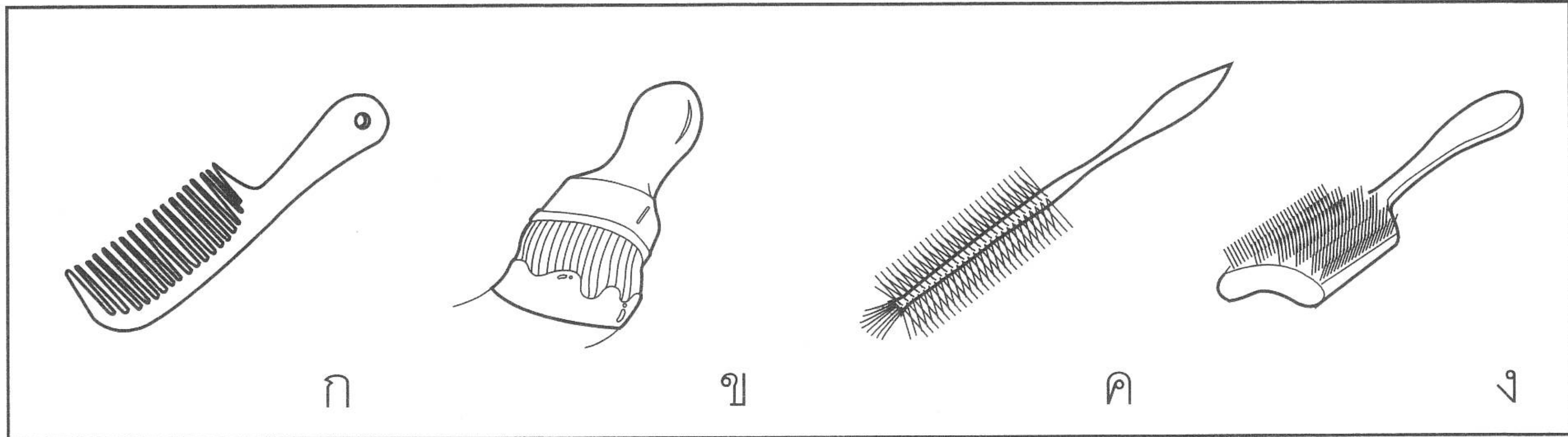

3

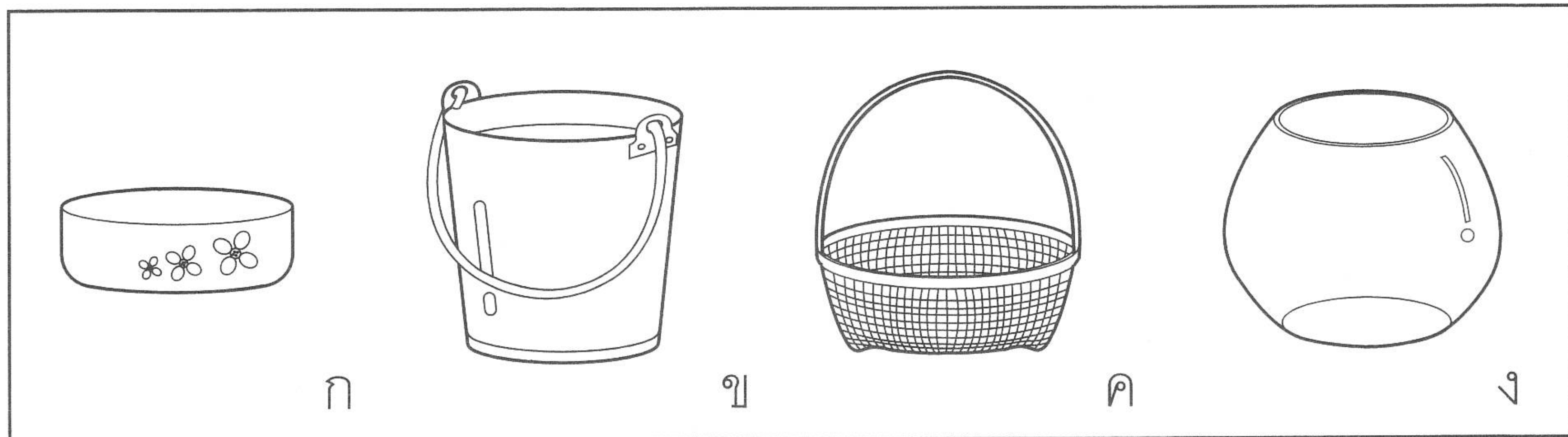

4

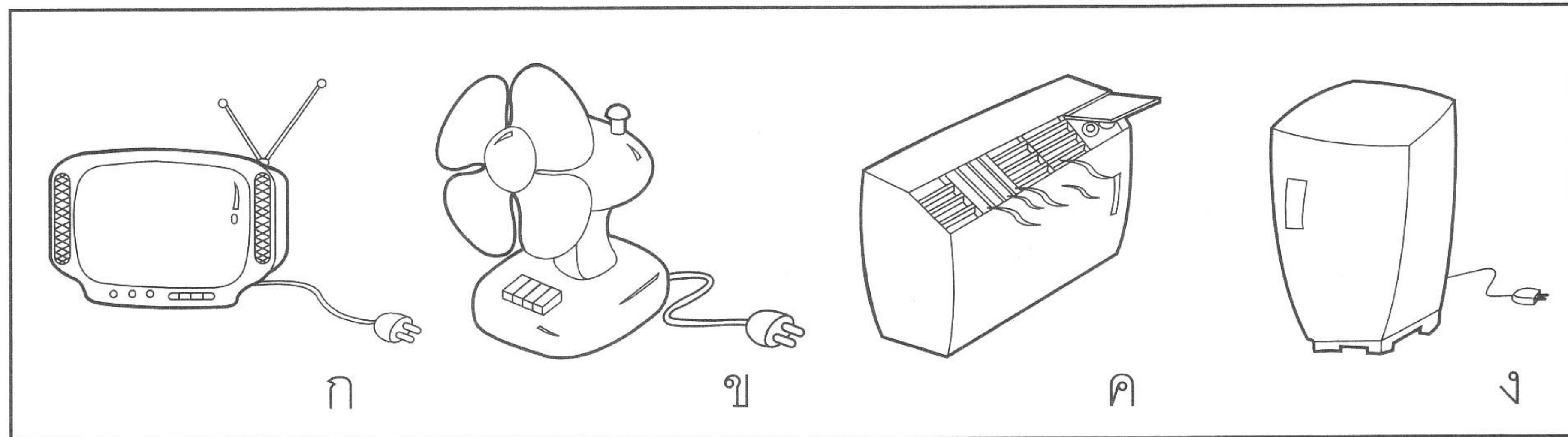

5

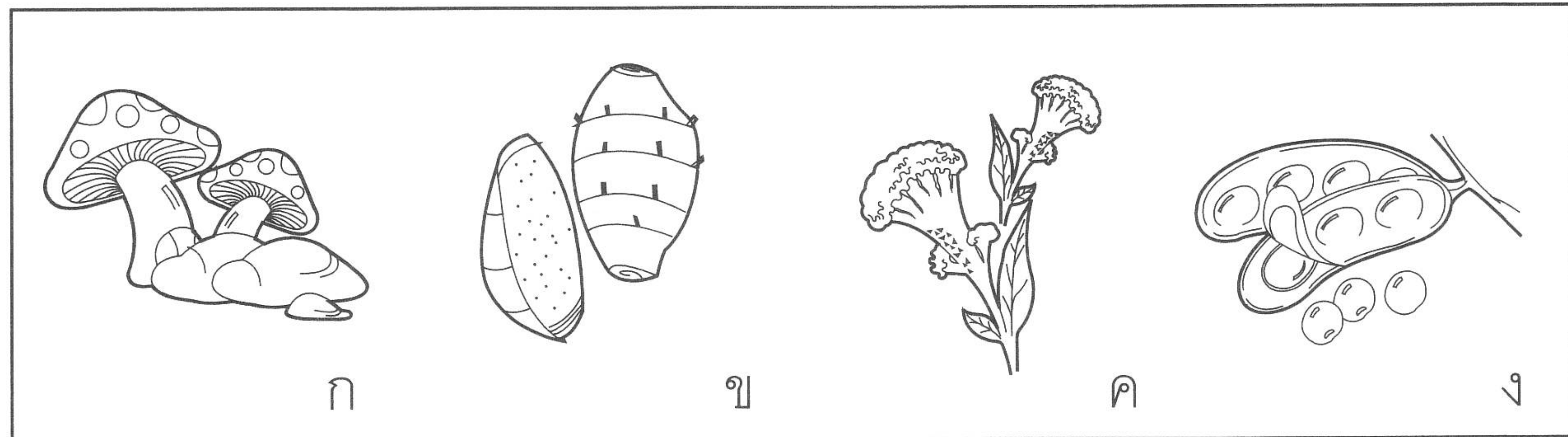

6

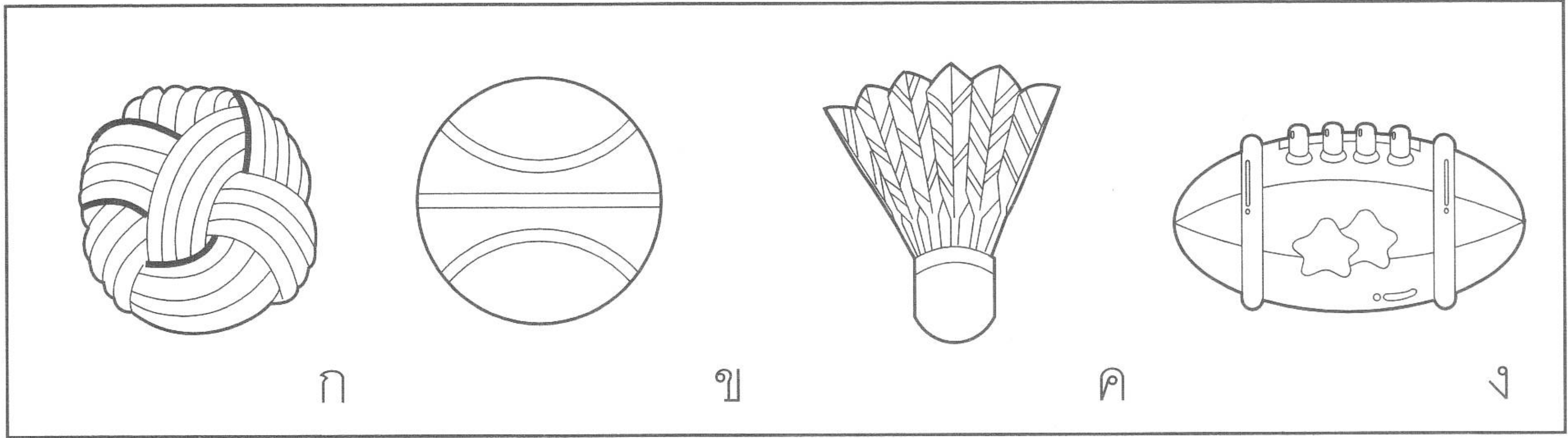

ก

ข

ค

ง

7

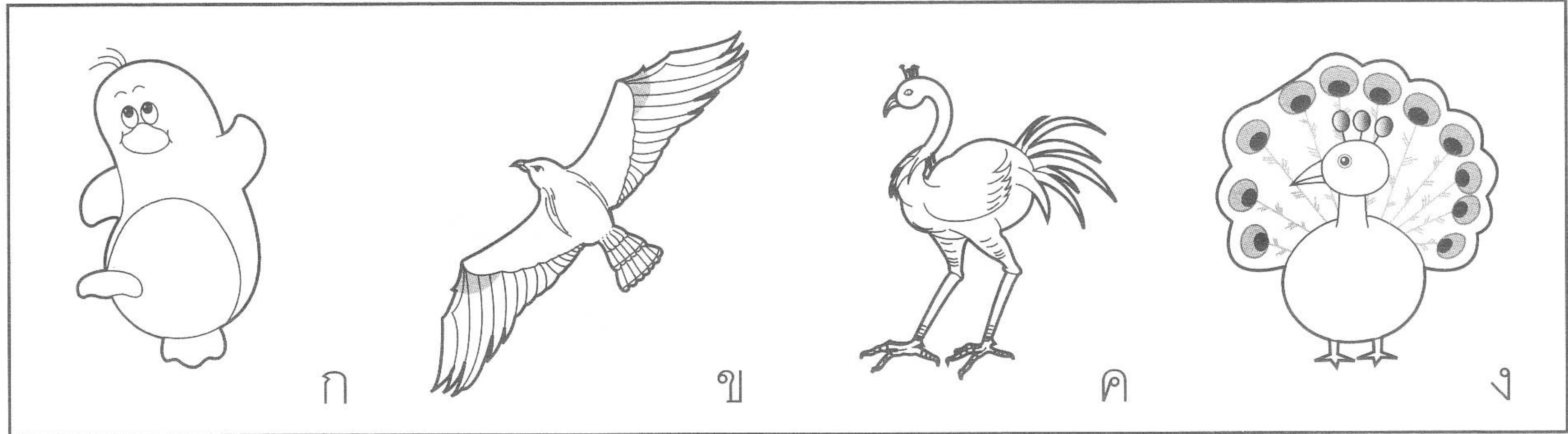

ก

ข

ค

ง

8

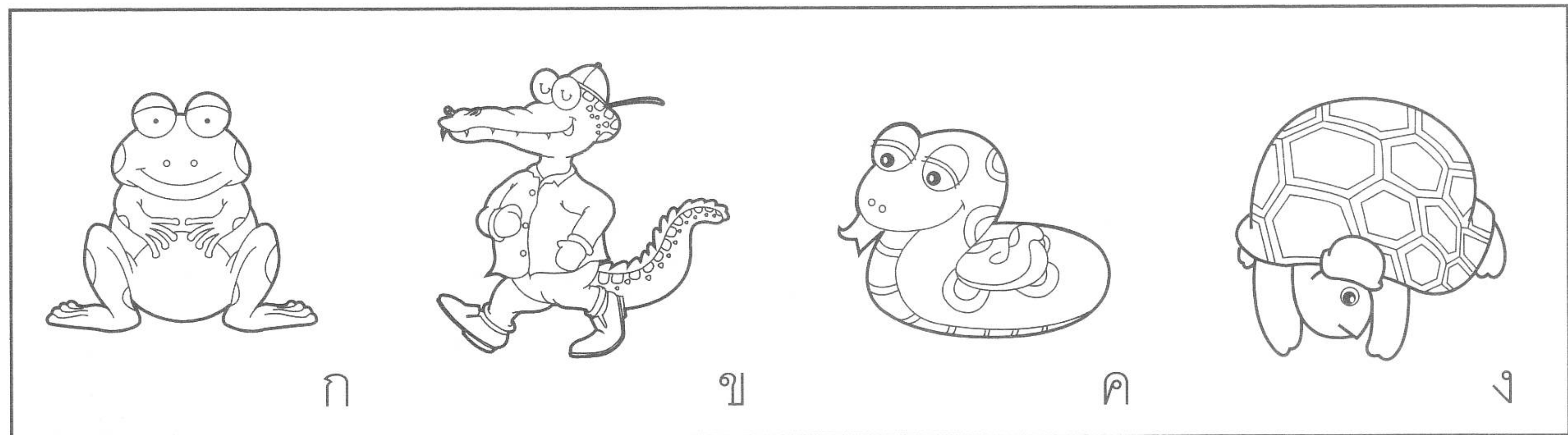

ก

ข

ค

ง

9

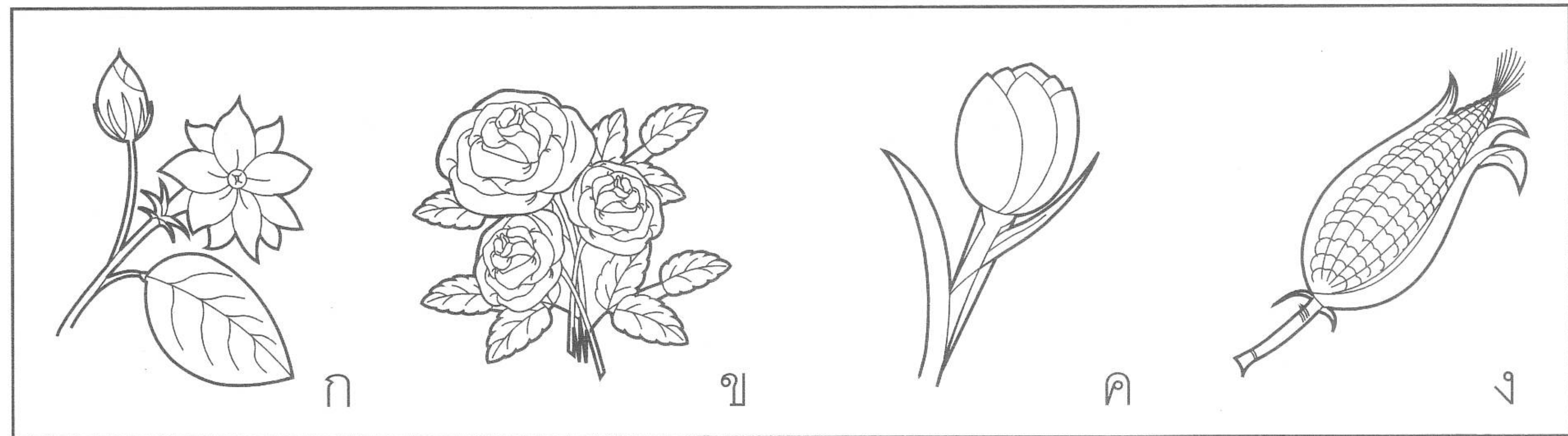

ก

ข

ค

ง

10

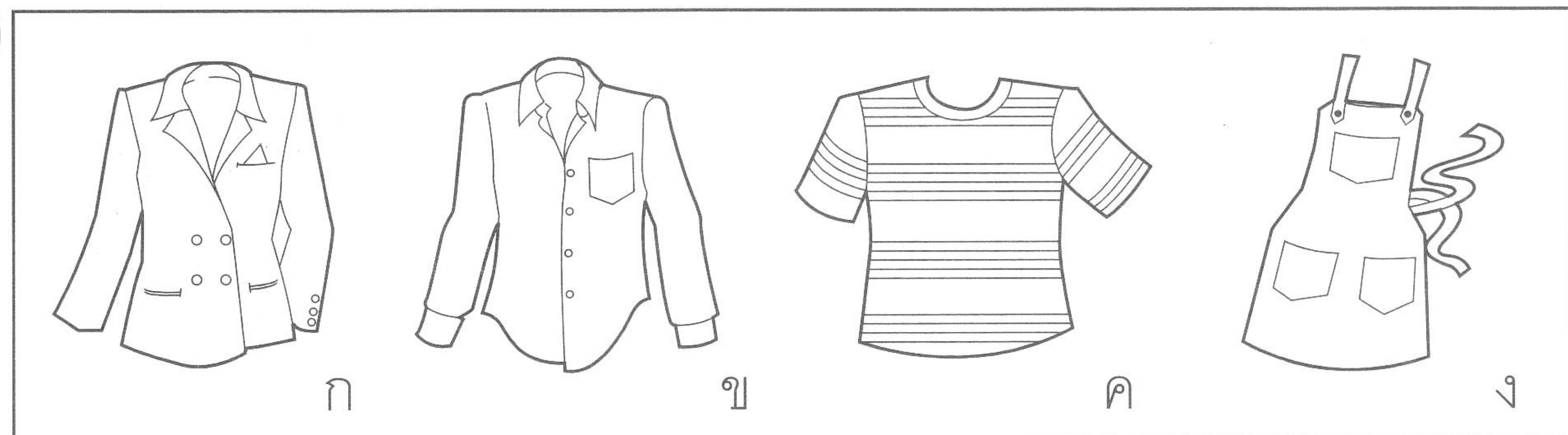

ก

ข

ค

ง

11

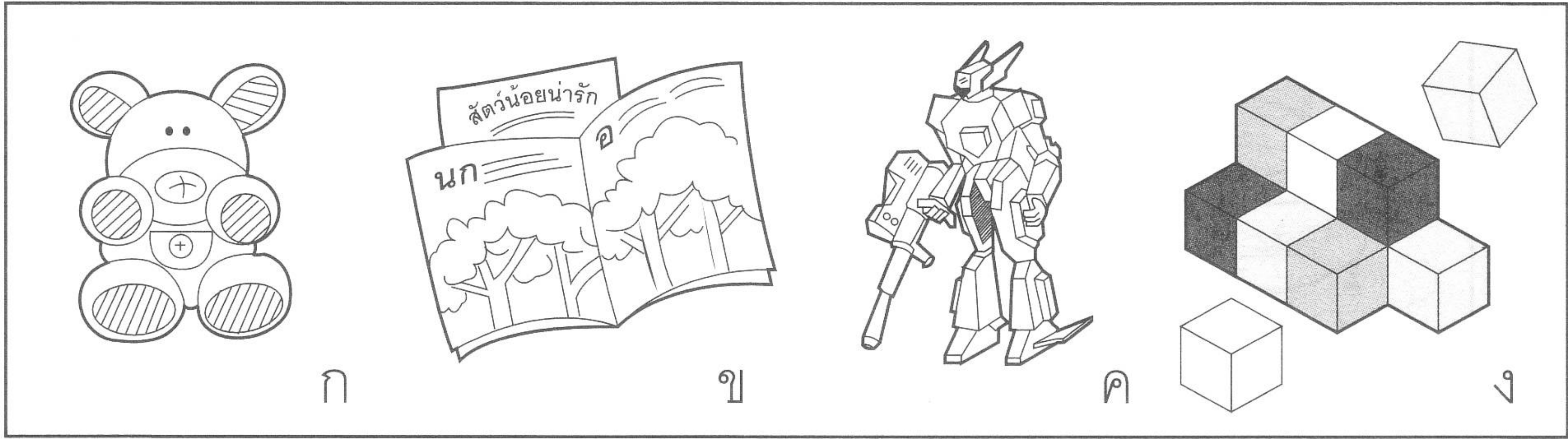

12

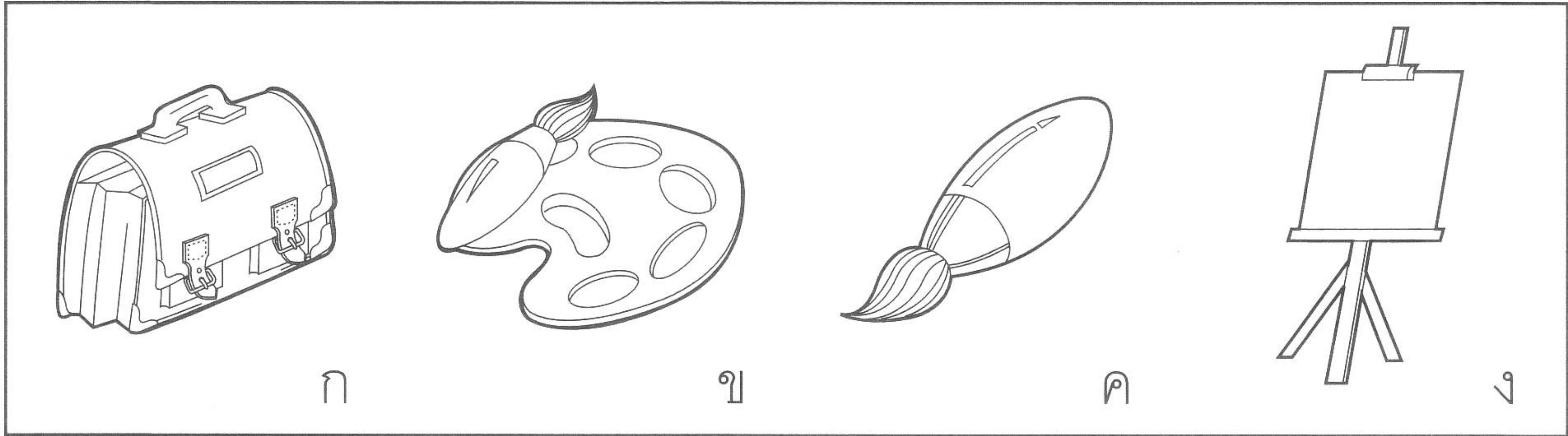

13

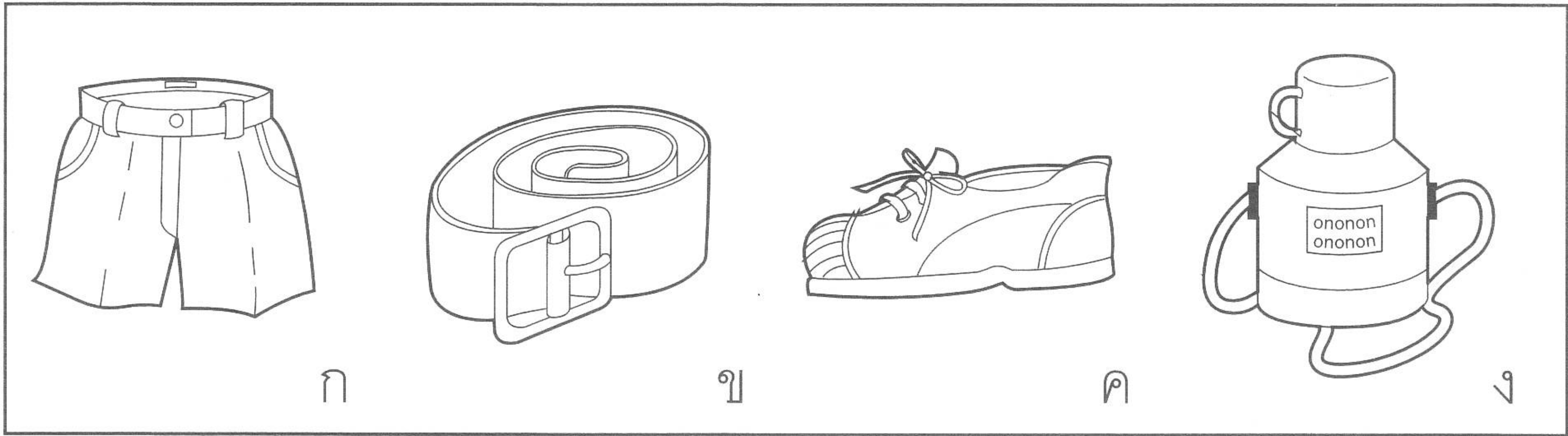

14

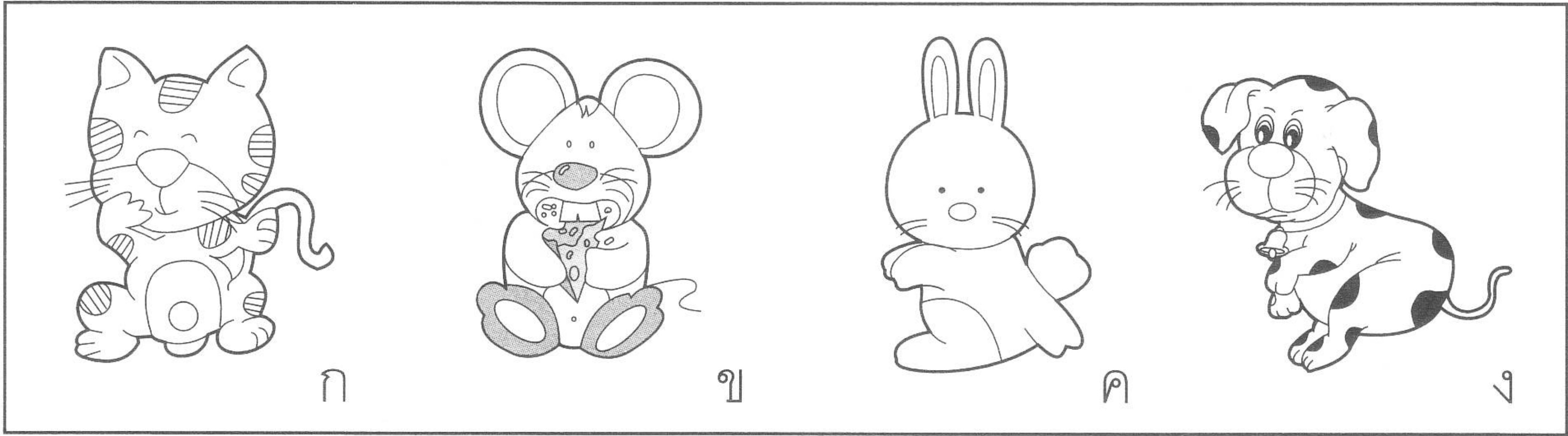

15

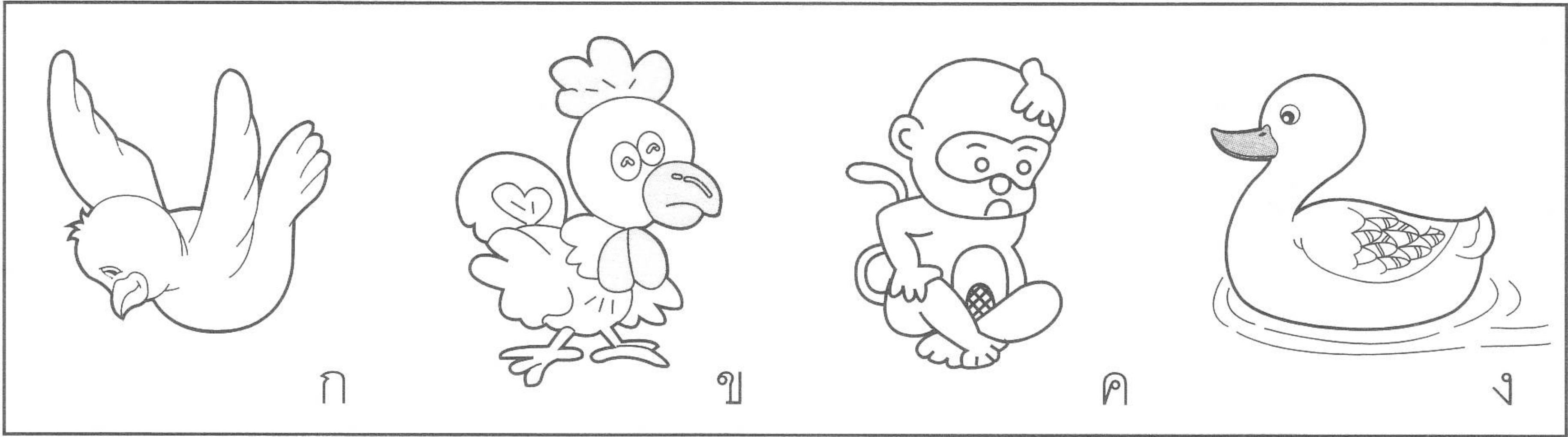

16

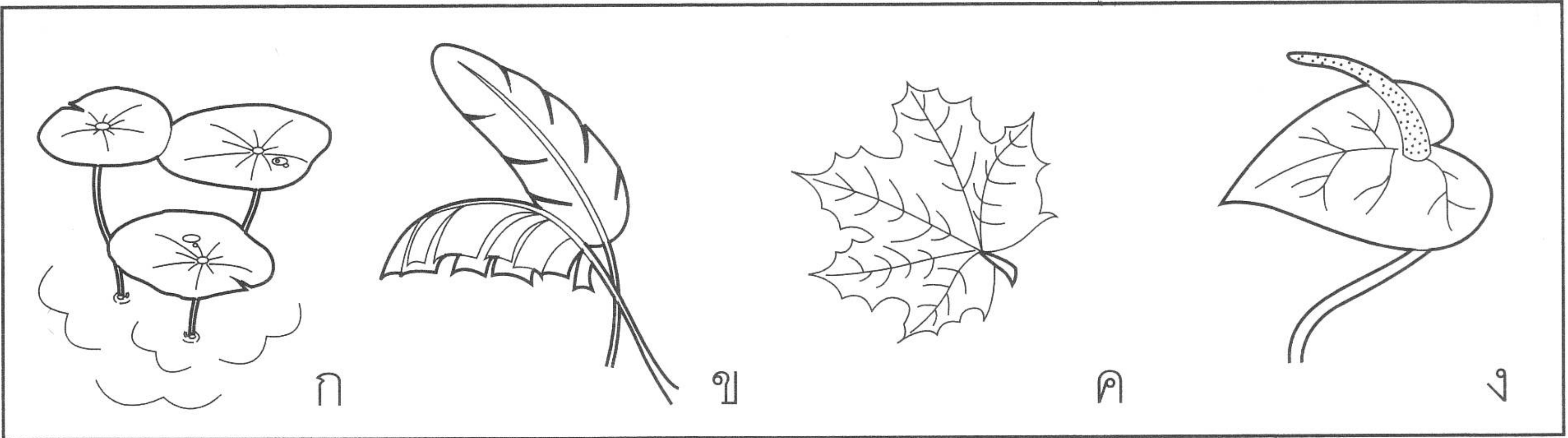

17

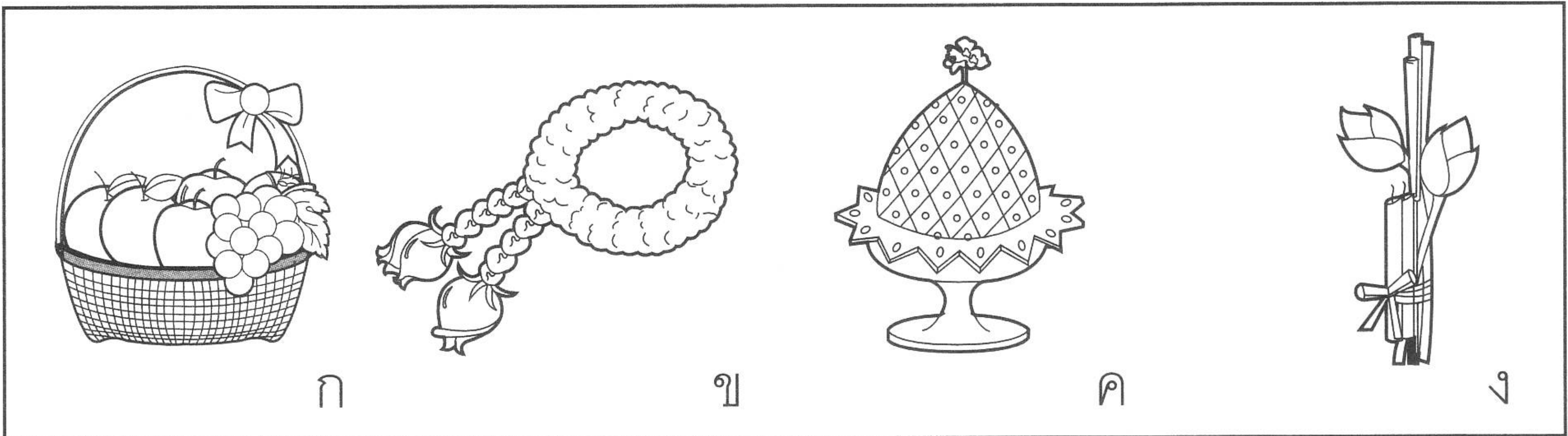

18

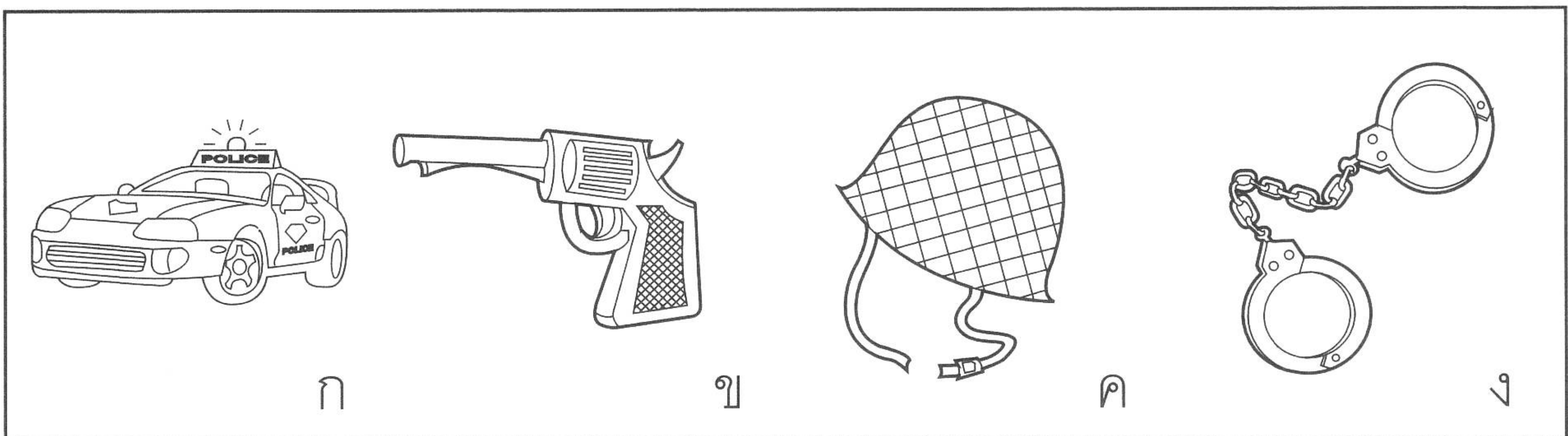

19

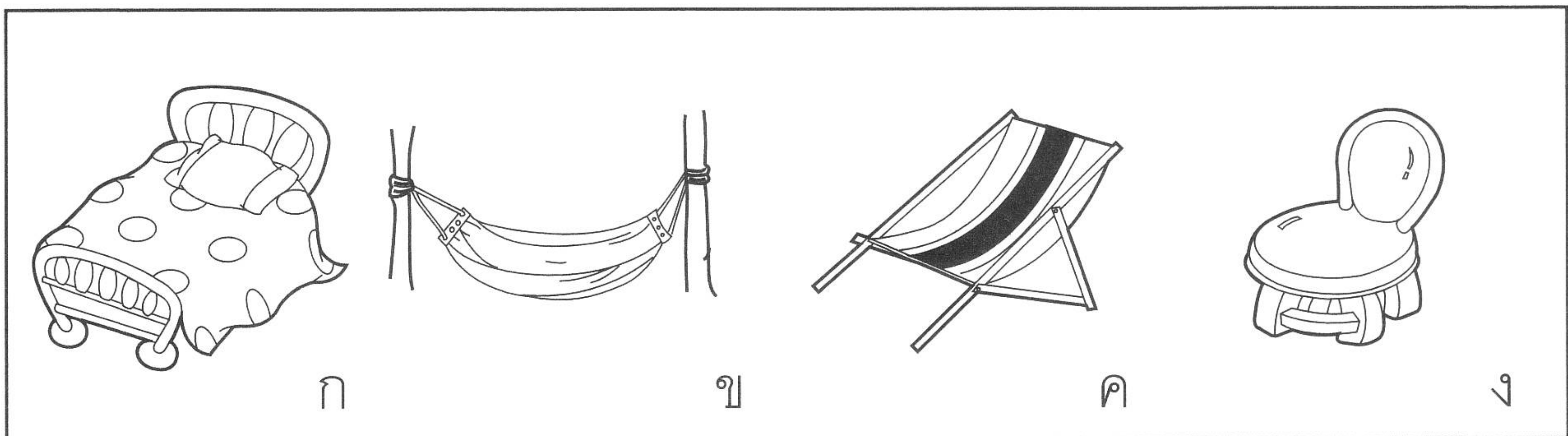

20

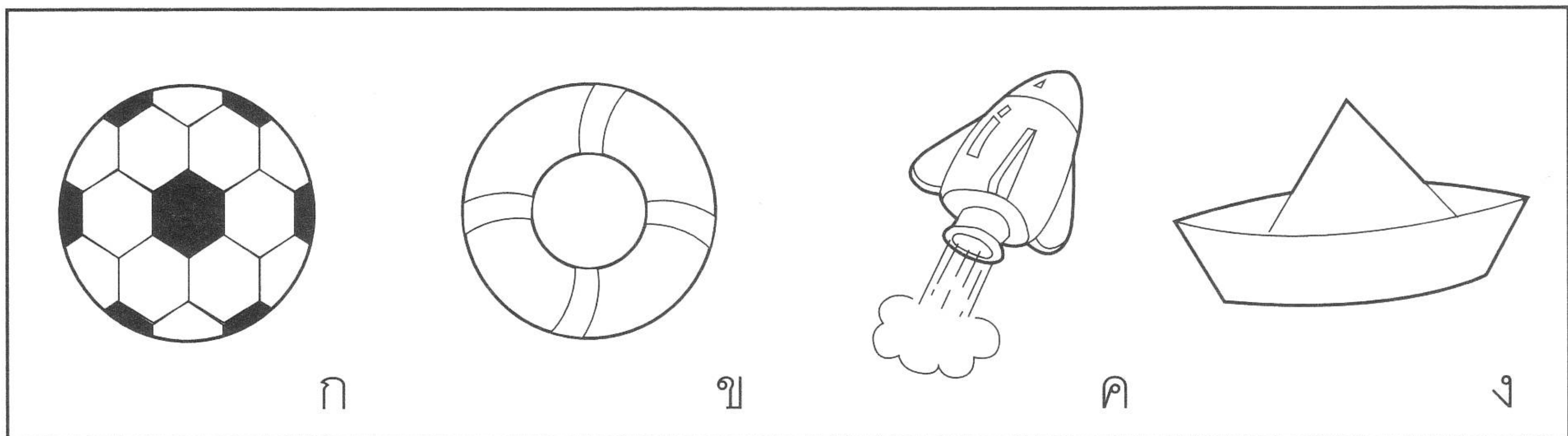

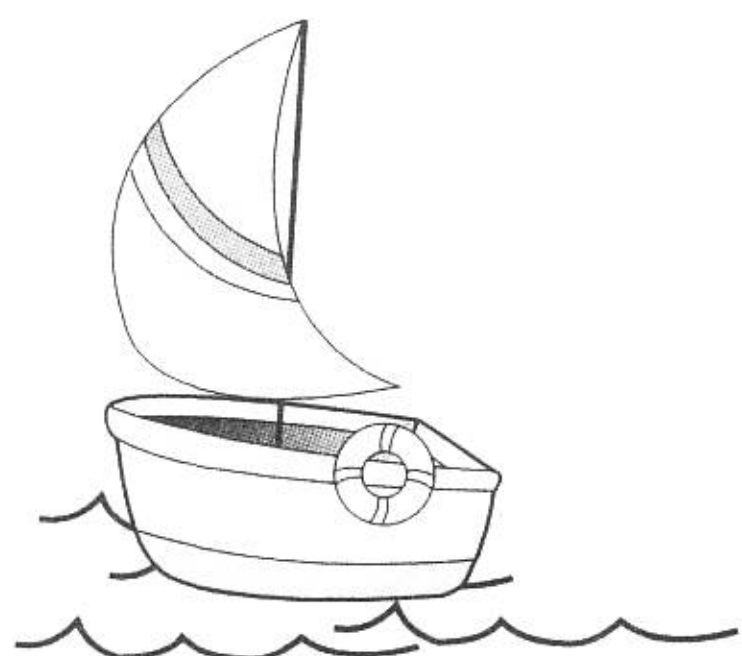

ตอนที่ 2

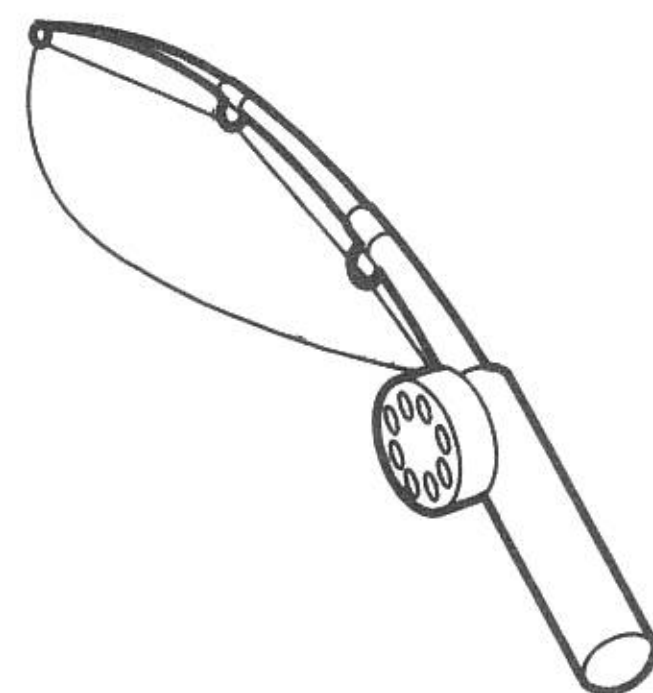

ลำดับเหตุการณ์

◇ เรียงลำดับเหตุการณ์จากภาพ 20 ข้อ

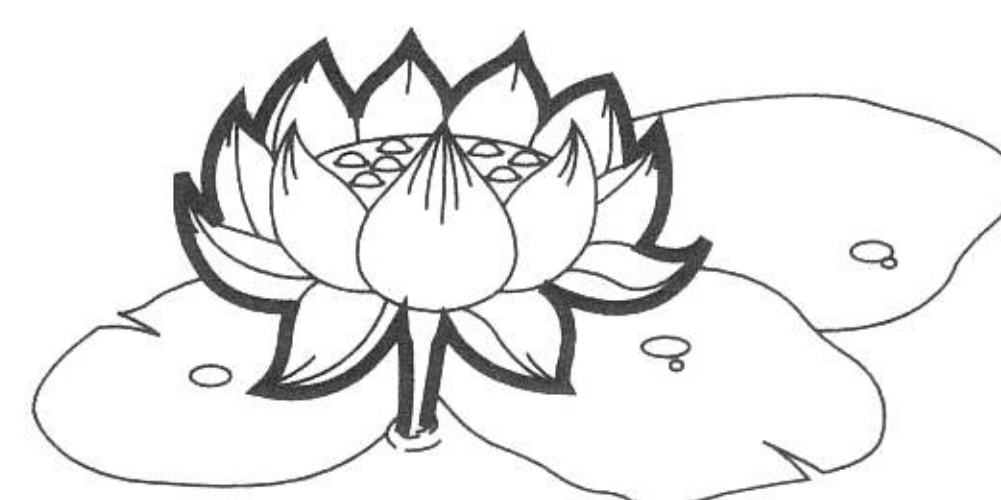

จงลำดับเหตุการณ์ โดยใส่ตัวเลขใน □

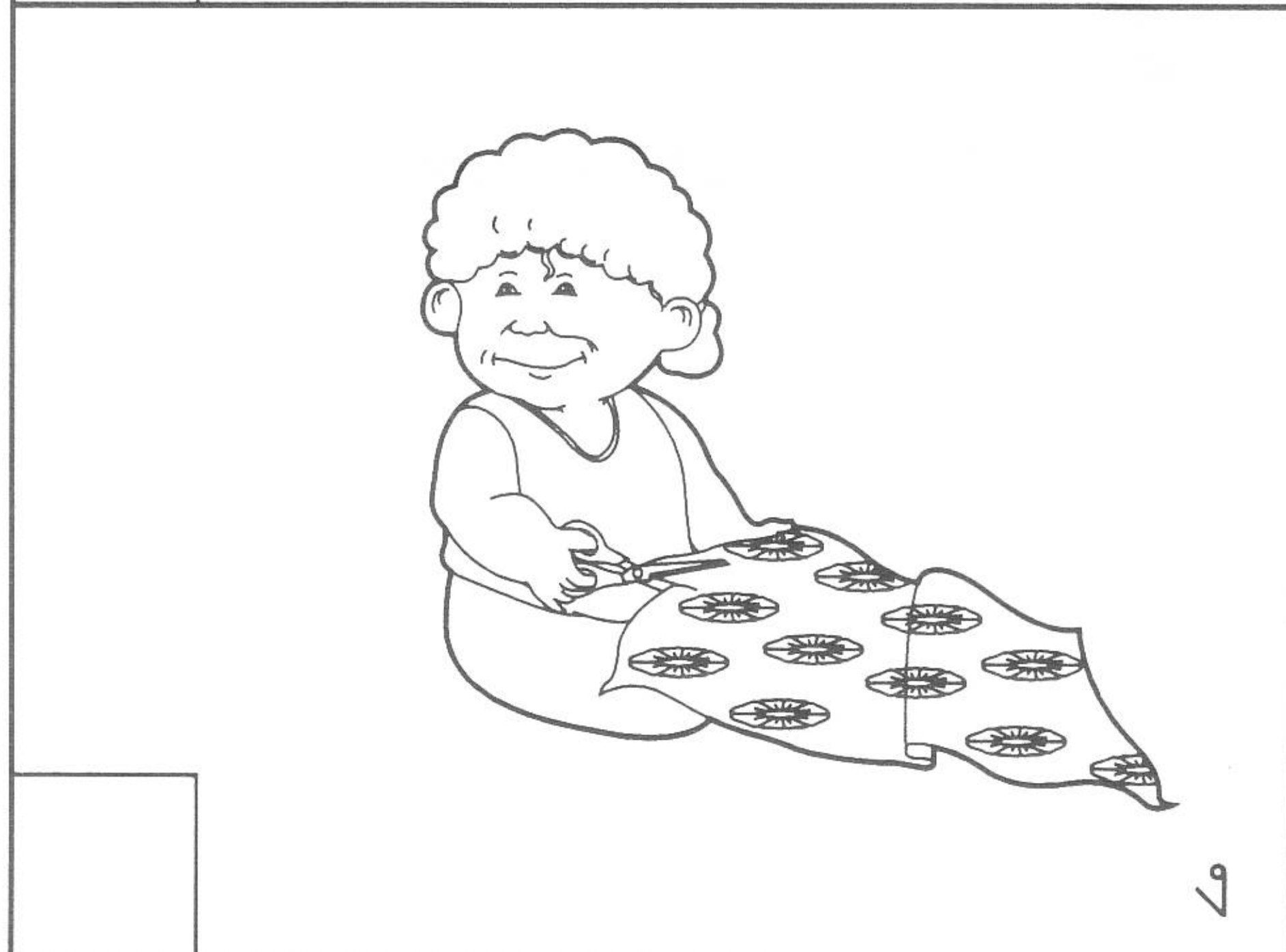
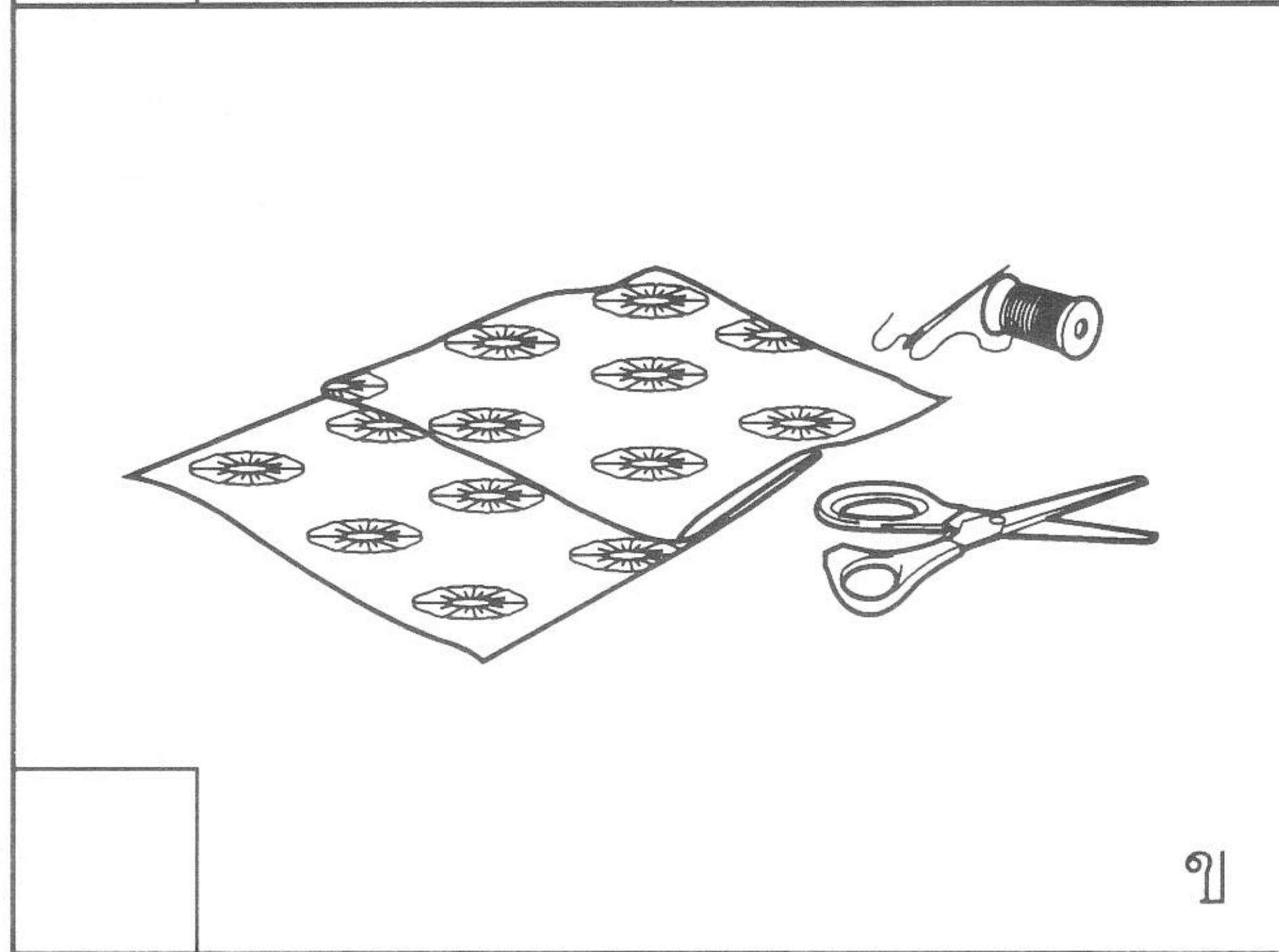
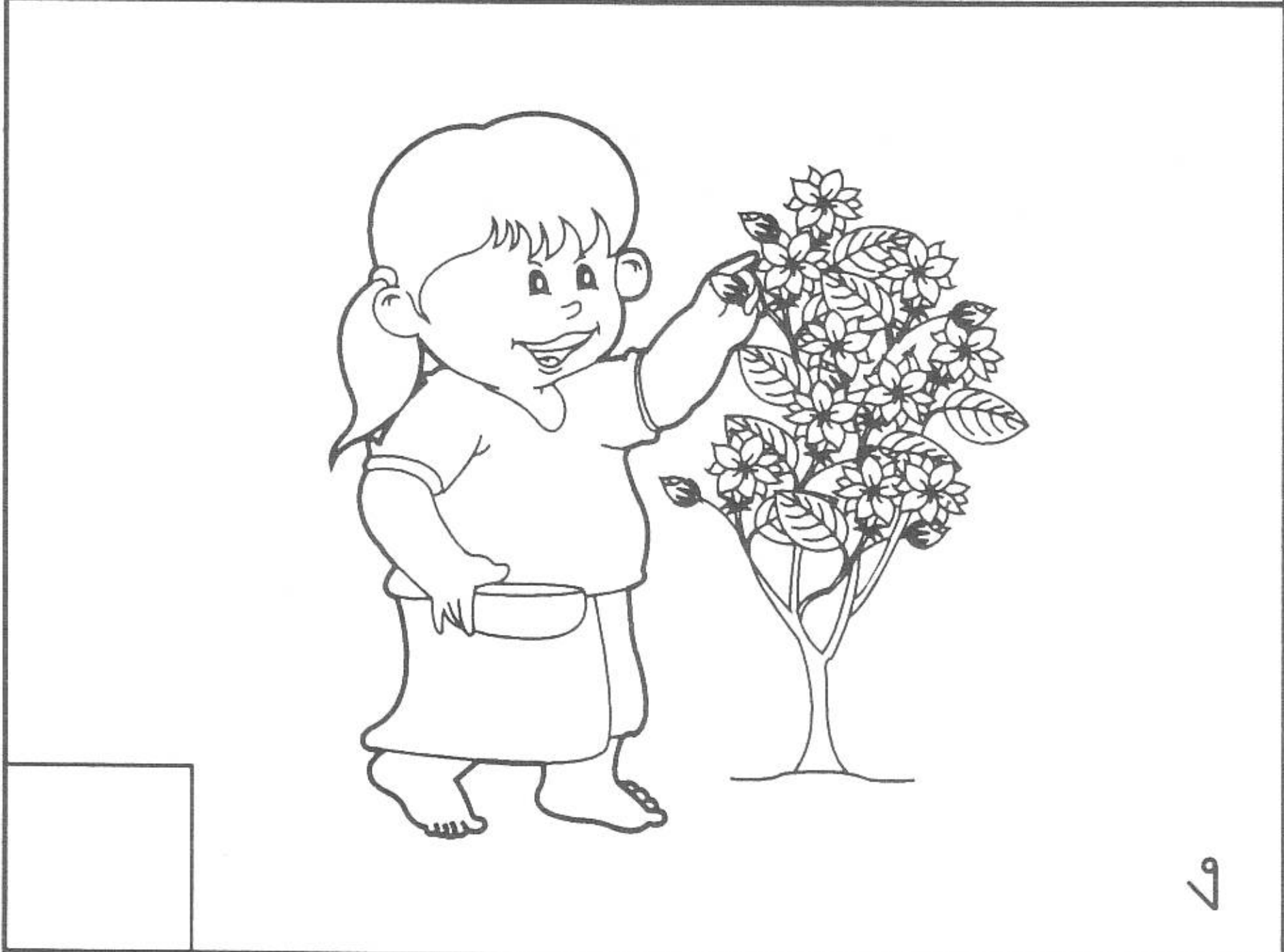
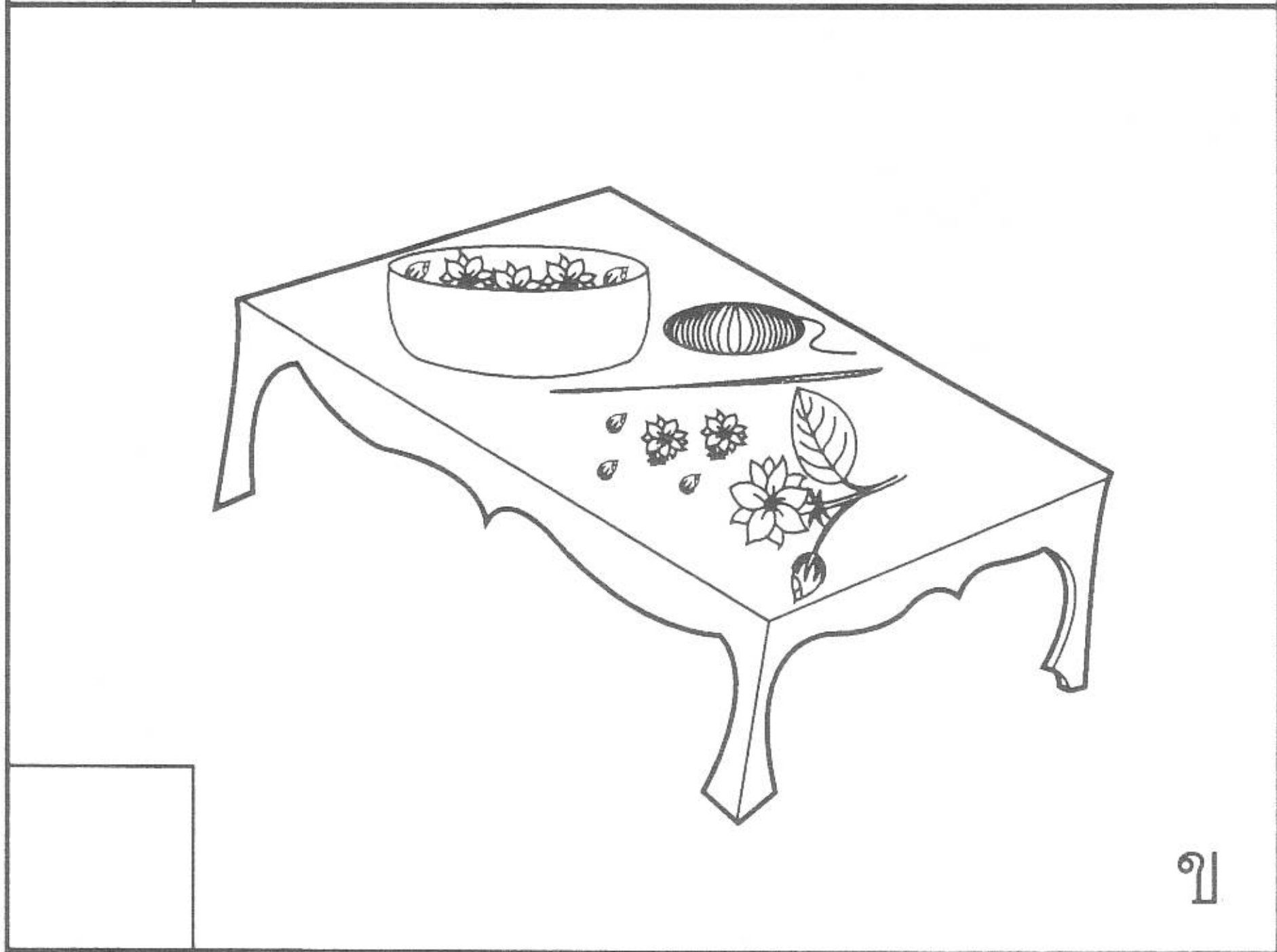

3

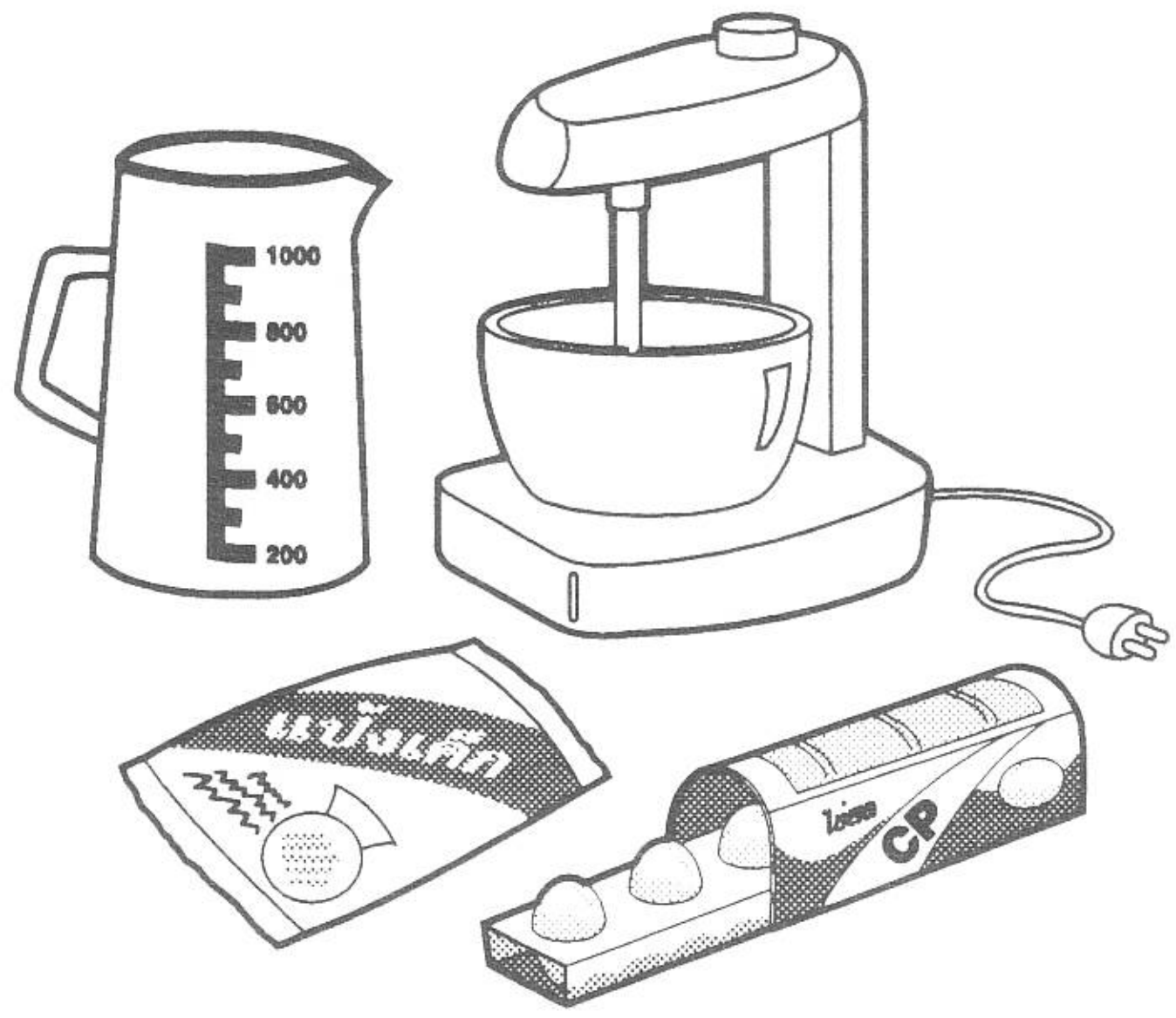

ก

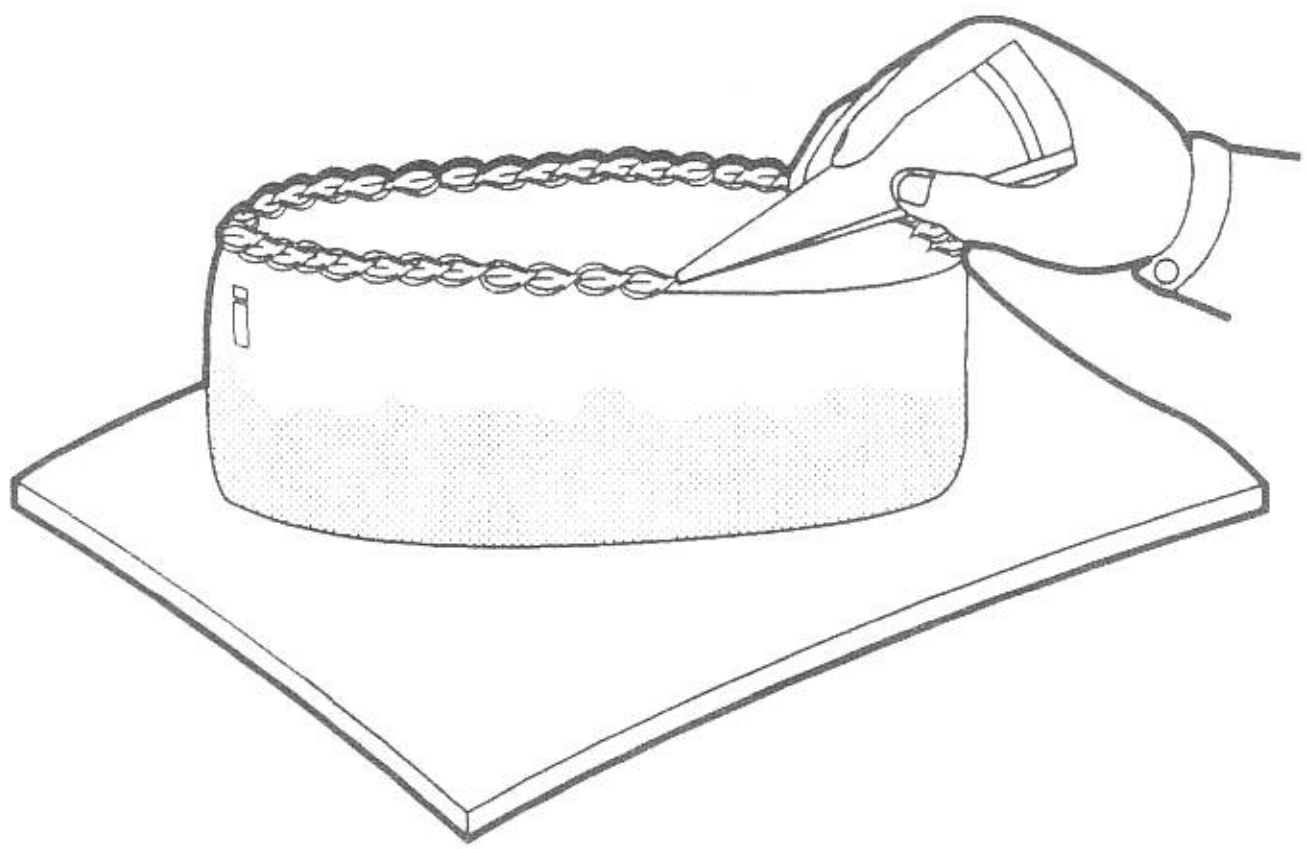

ข

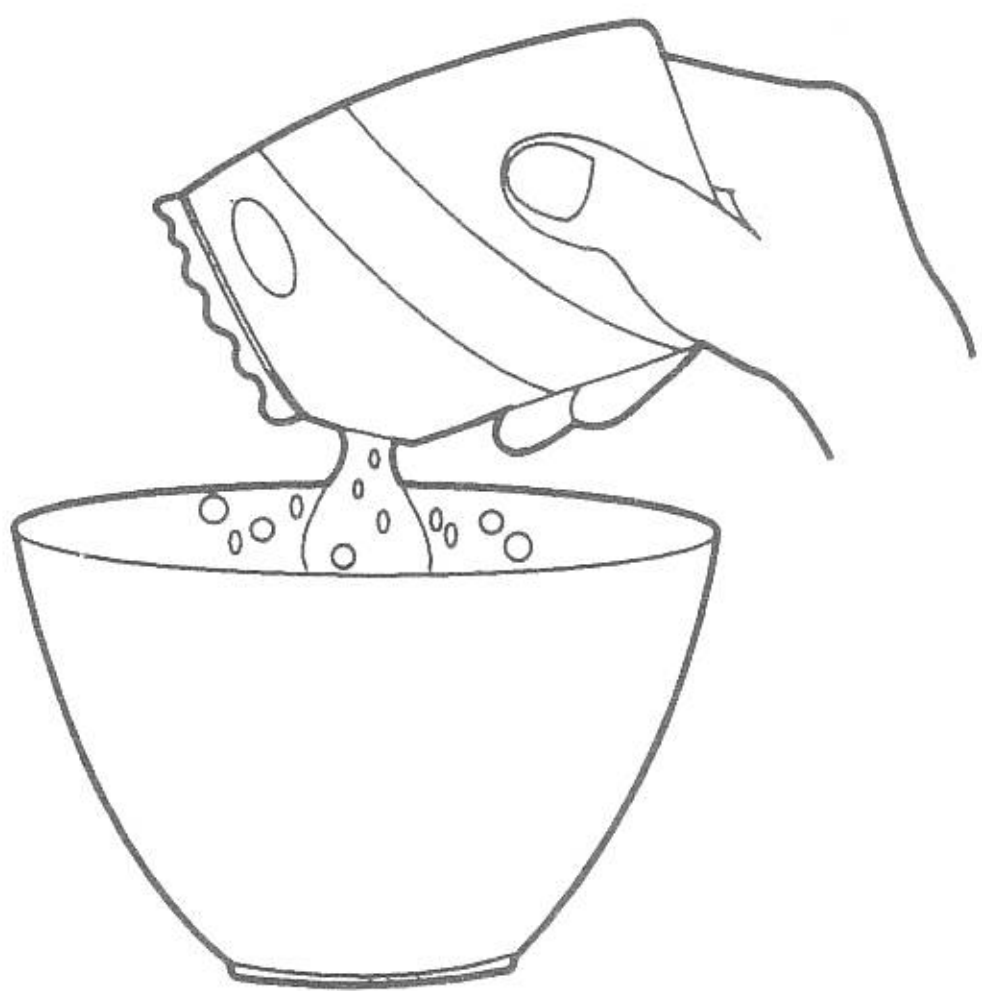

ค

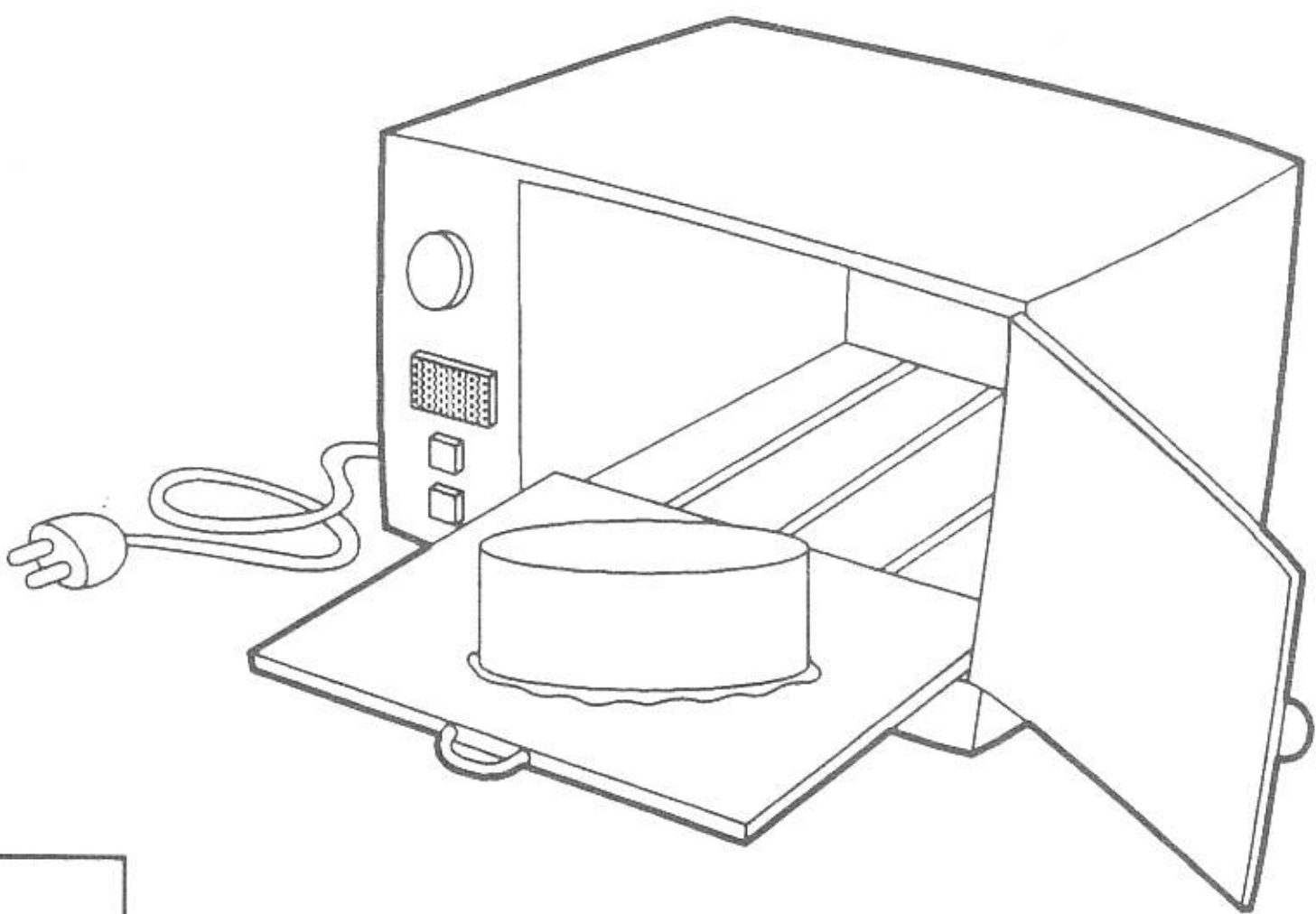

ง

4



ก



ข



ค



ง

5



ก



ข



ค



ง

6

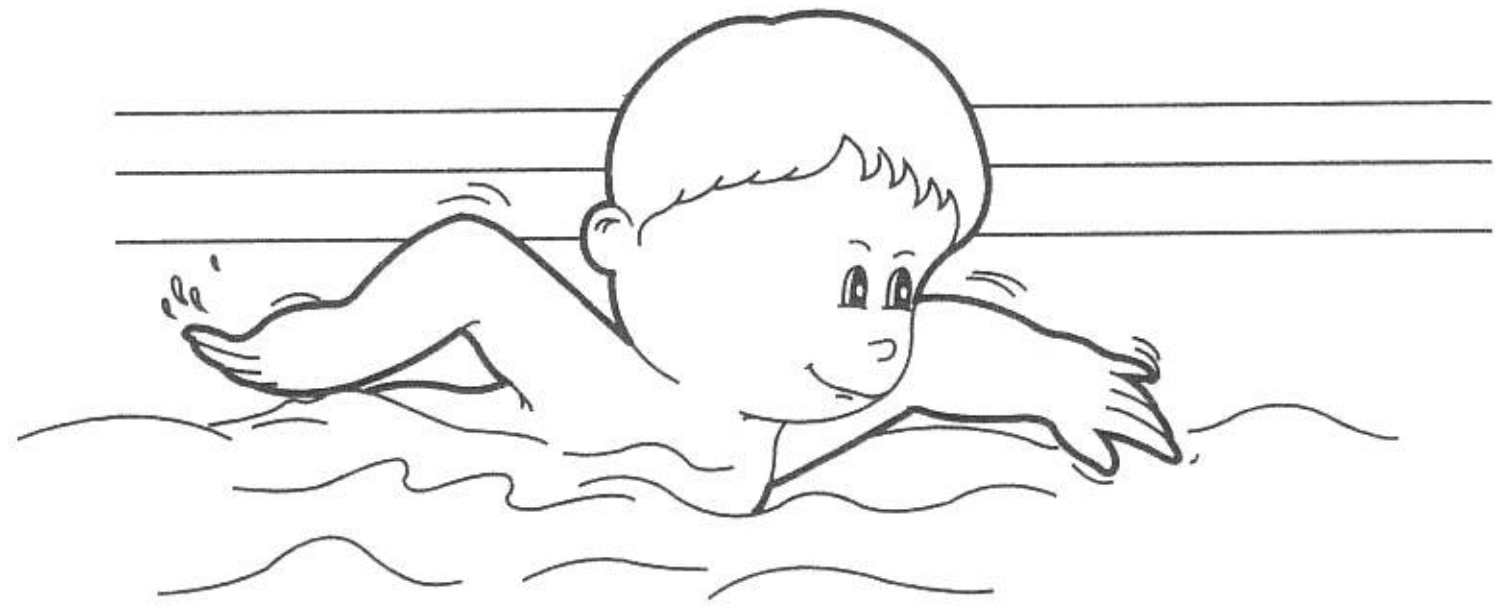

ก



ข



ค



ง

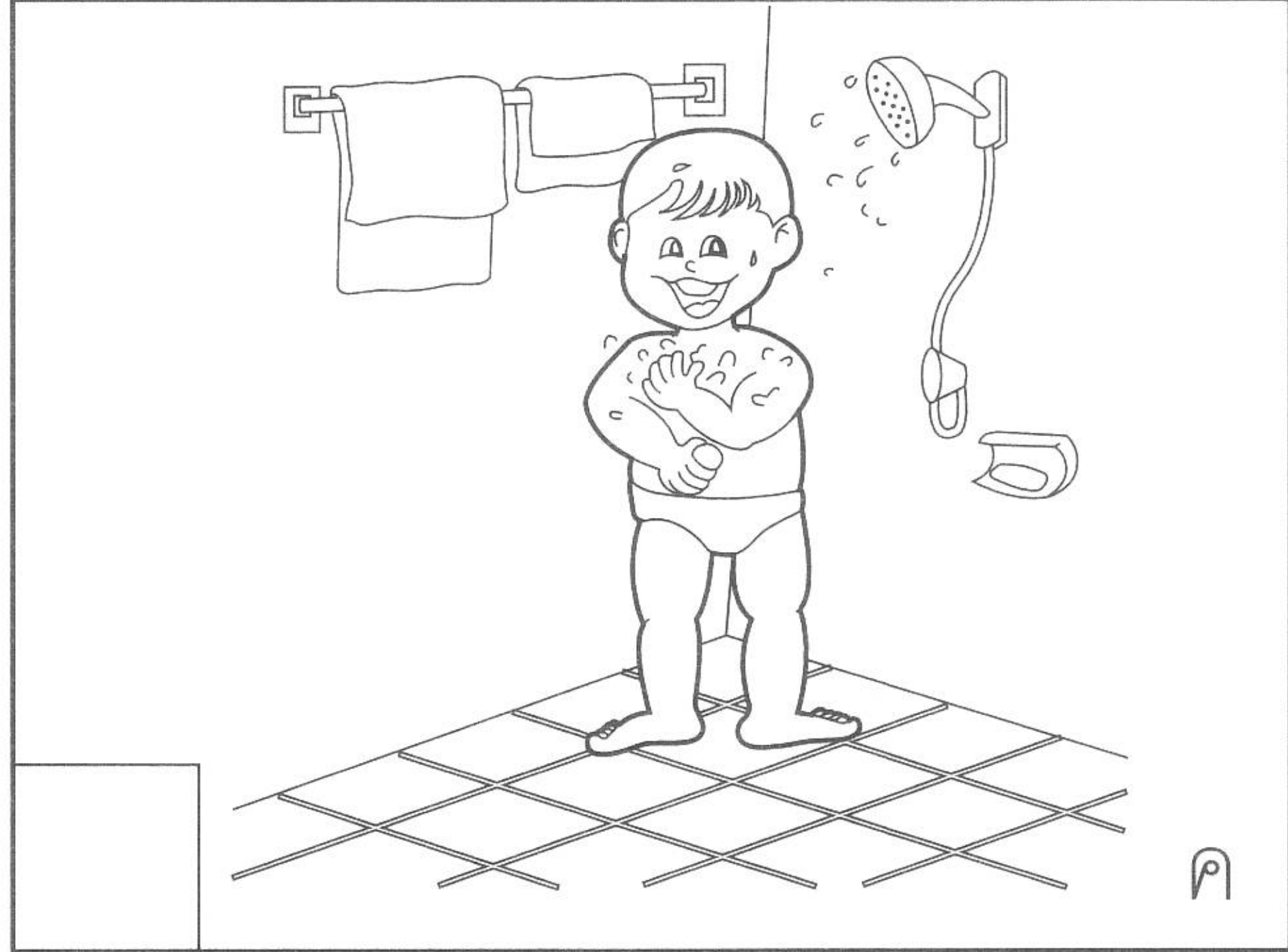
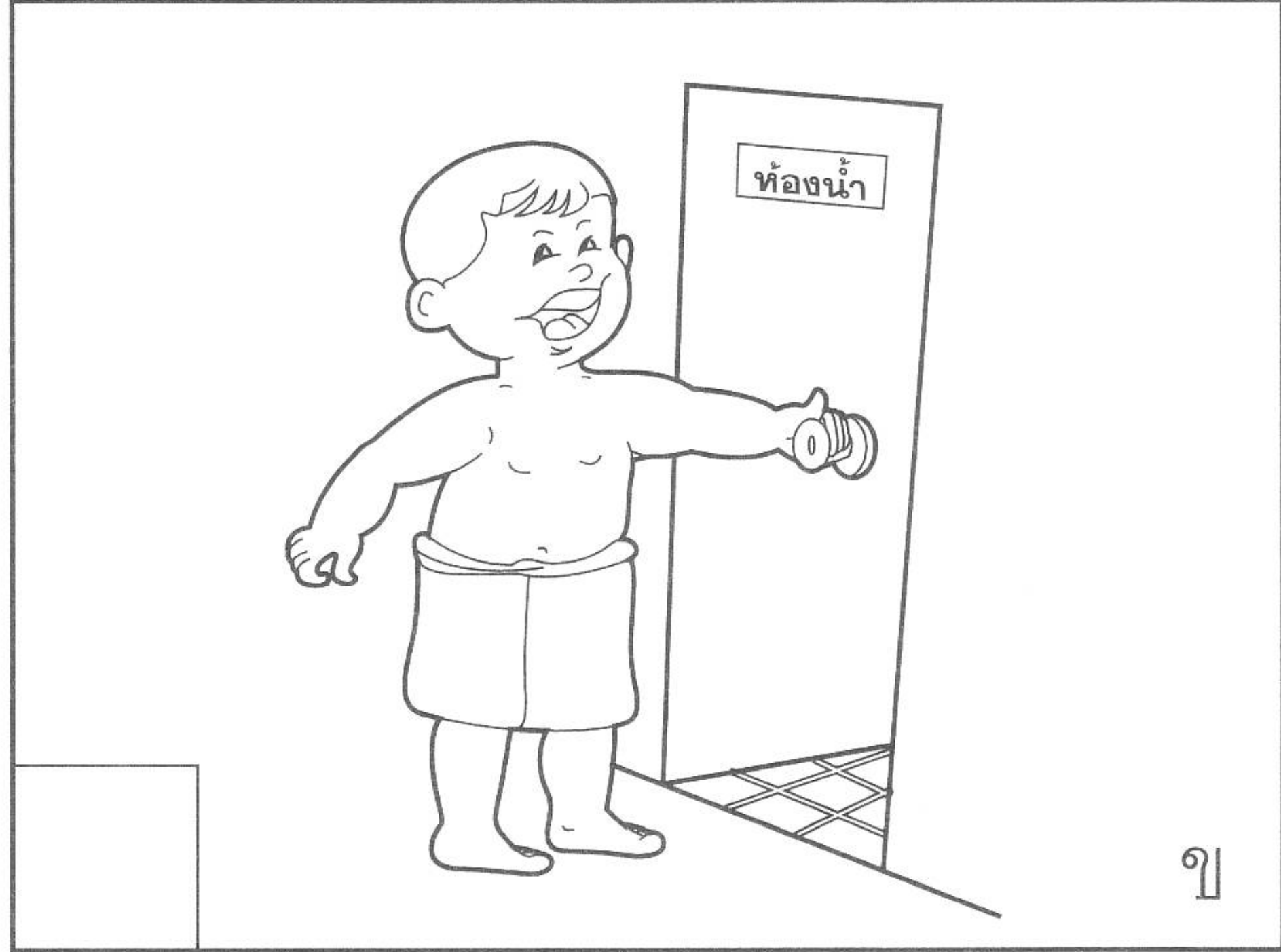
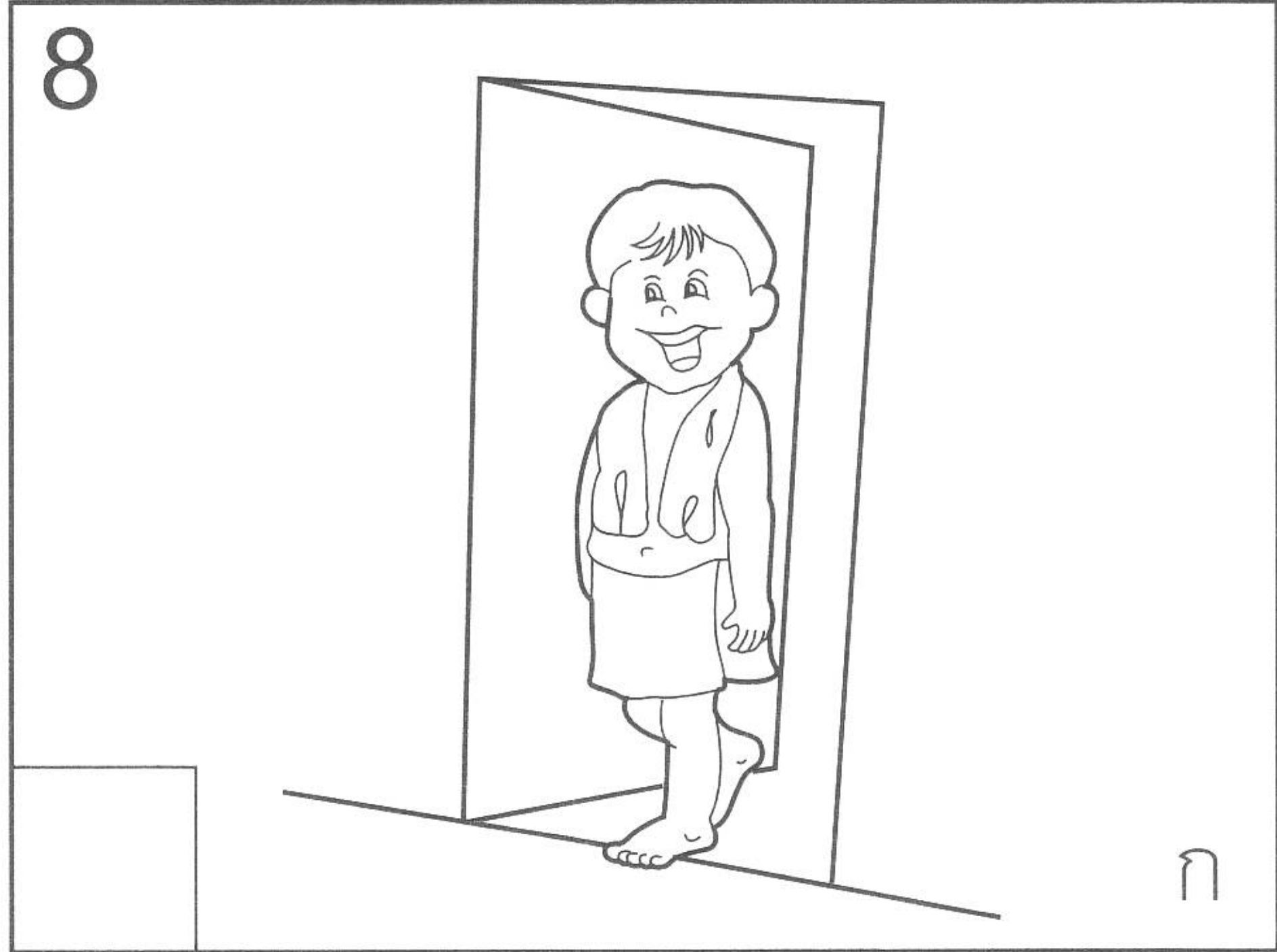
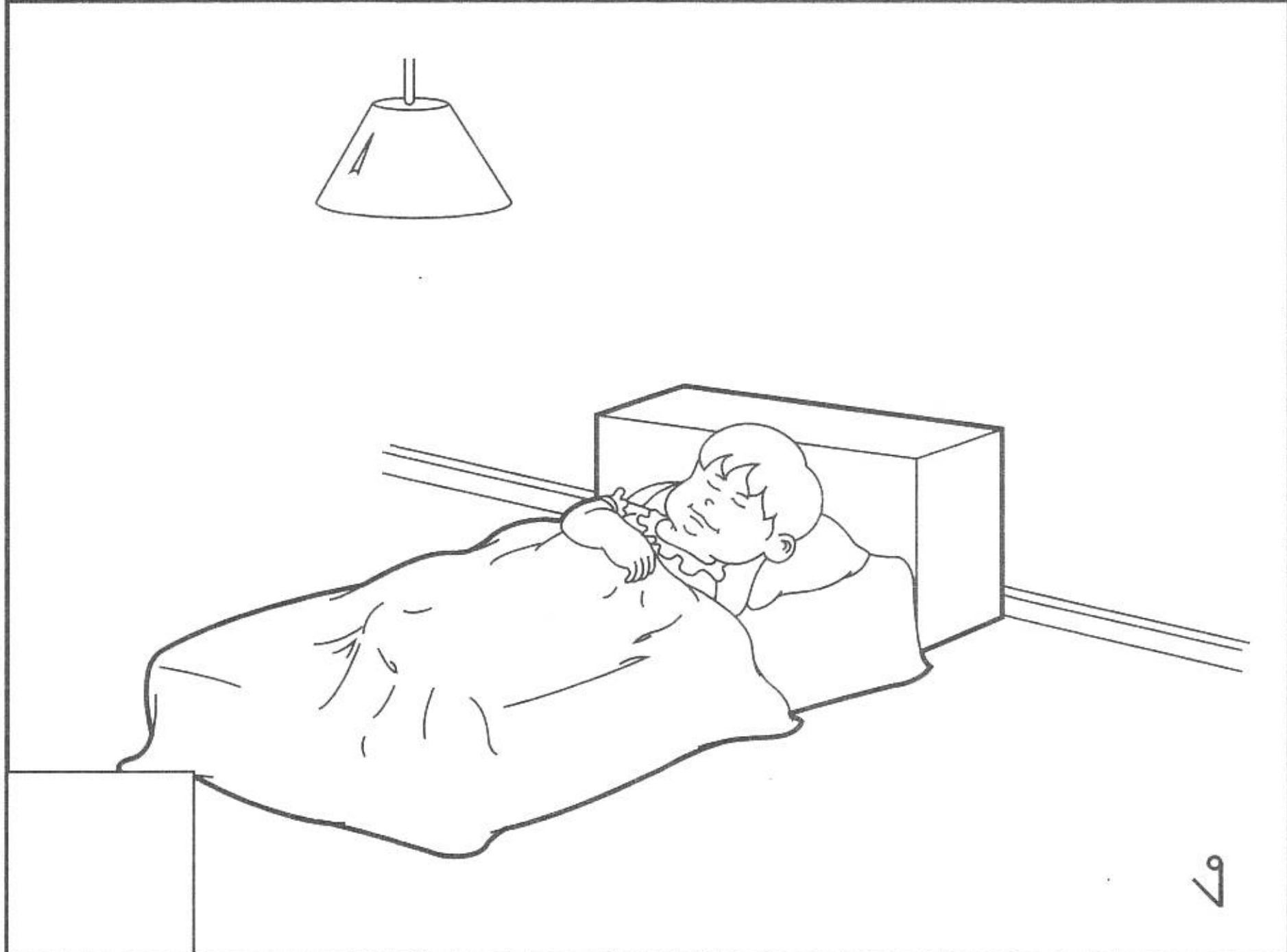
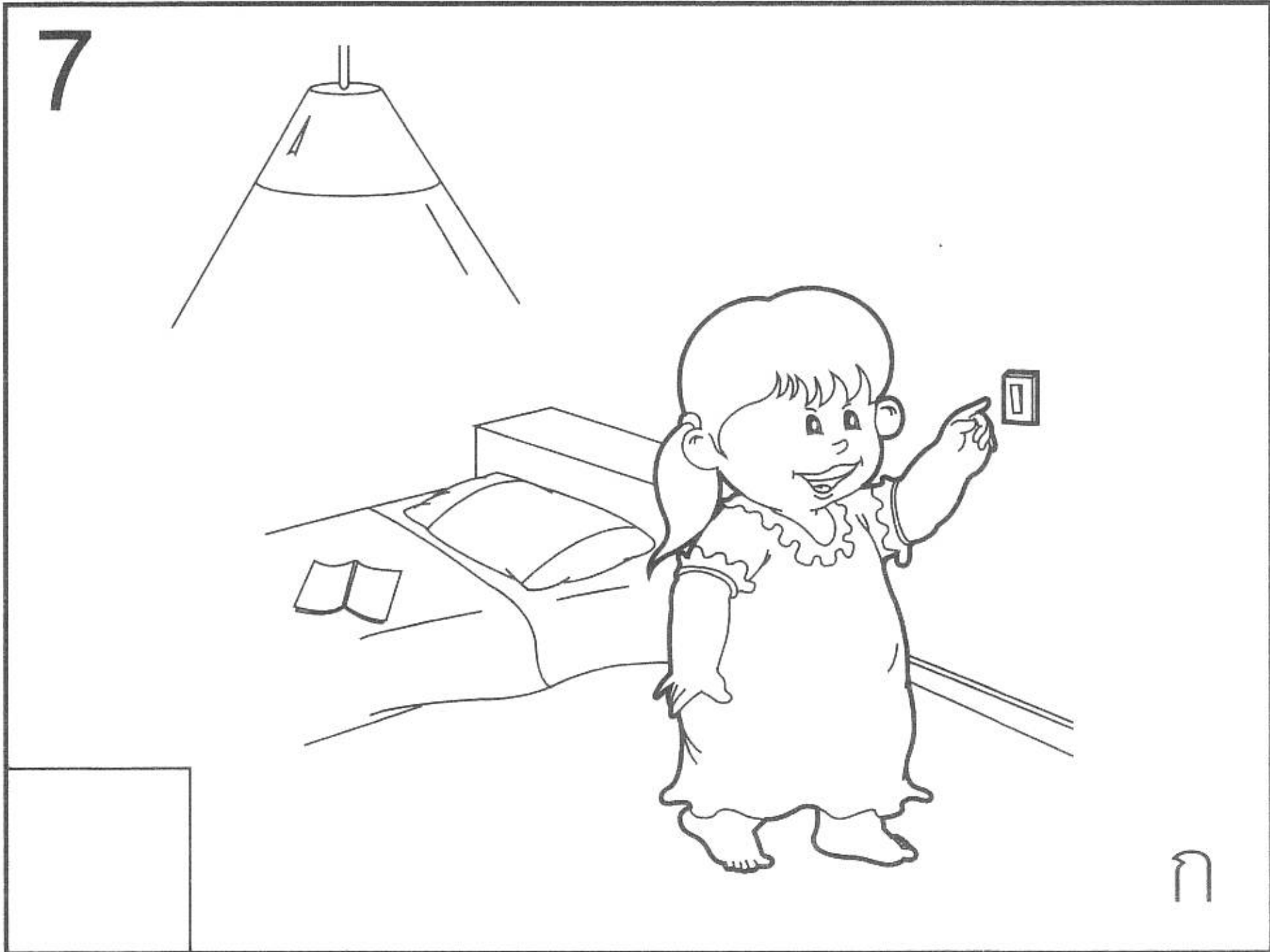

9



ก

10

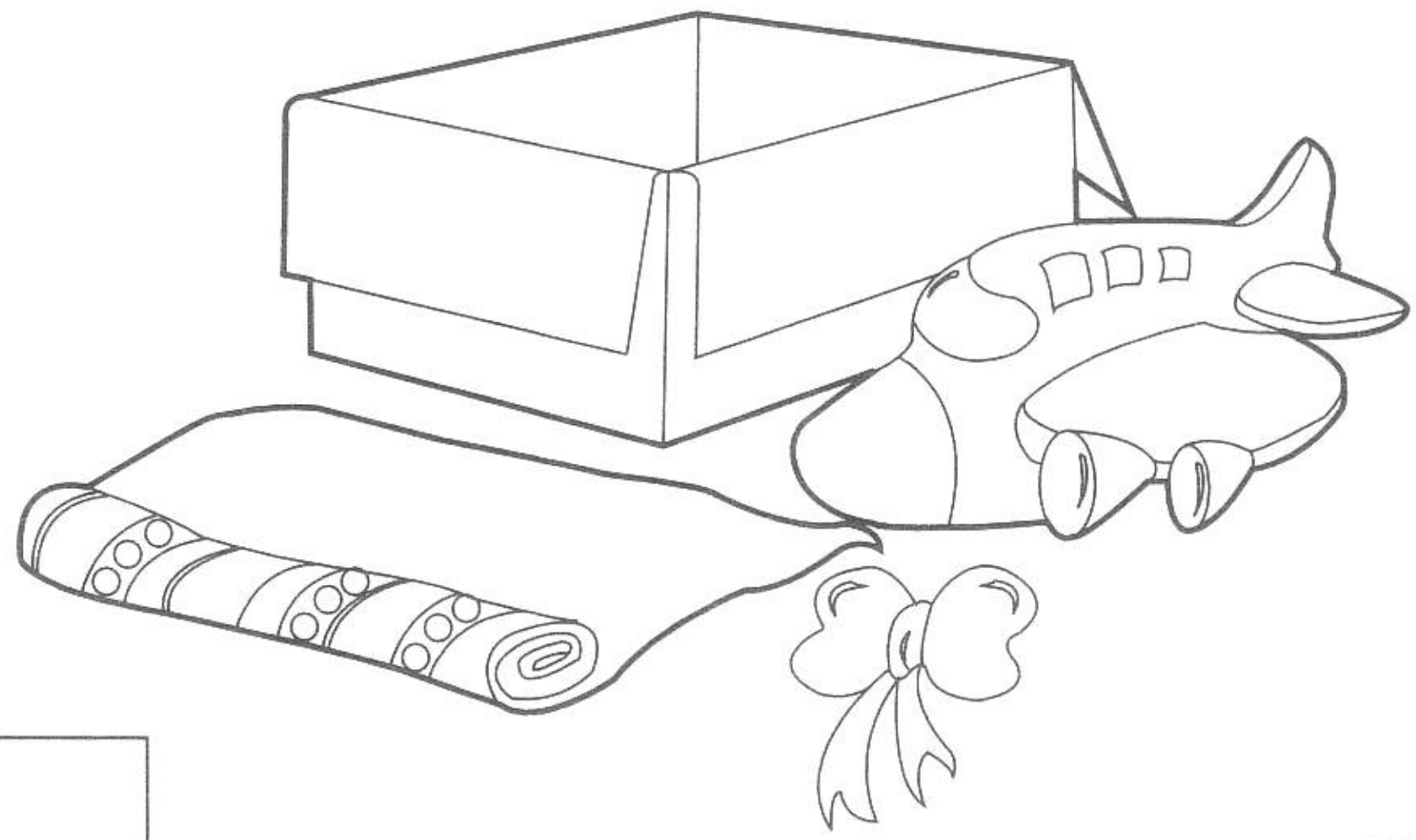

ก



ข

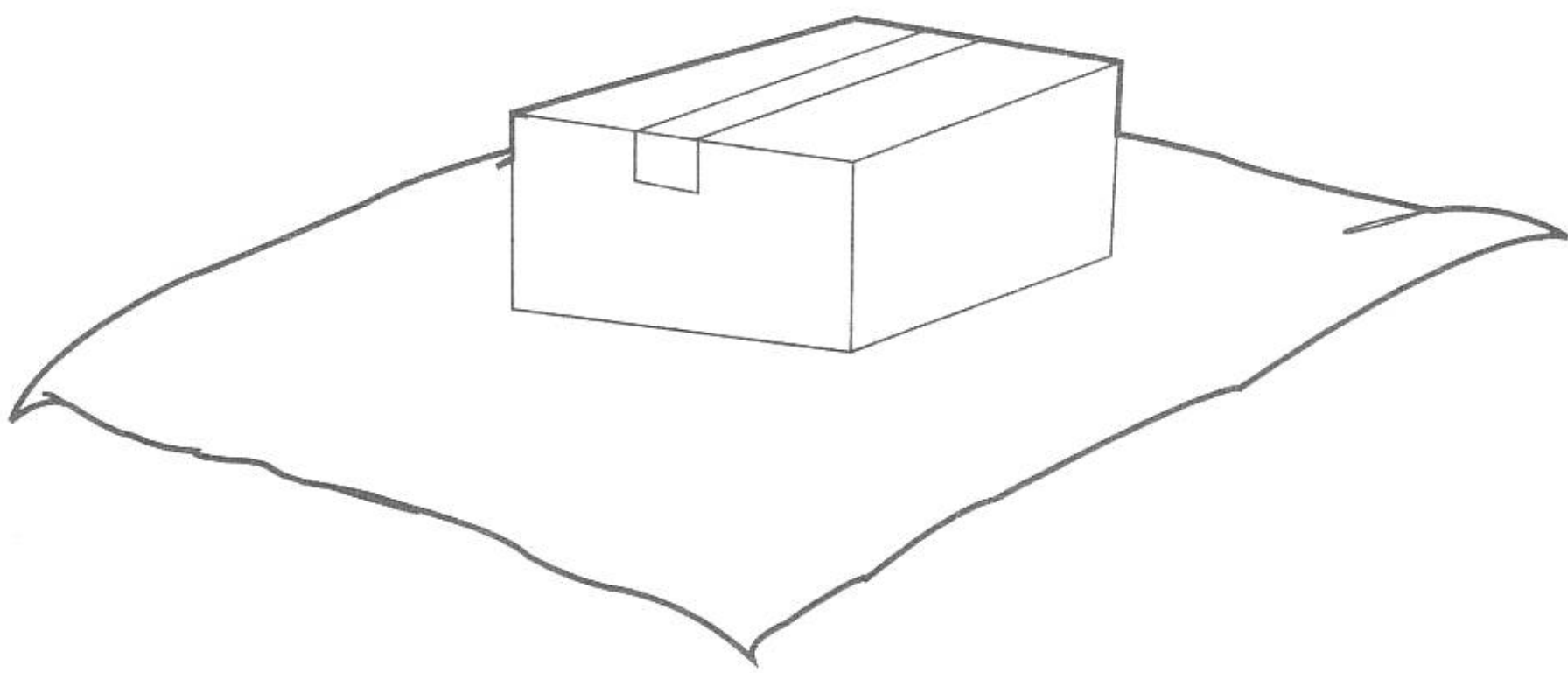

ข



ค

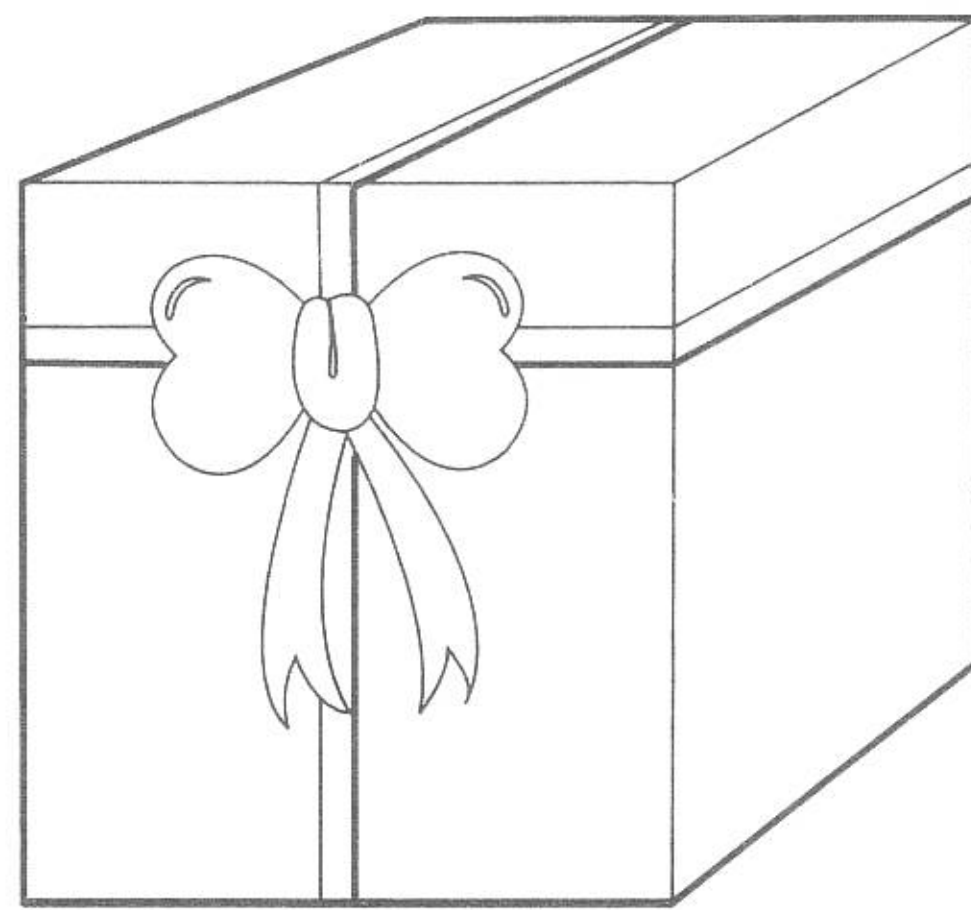

ค



ง



ง

11



၈



၅



၆



၇

12

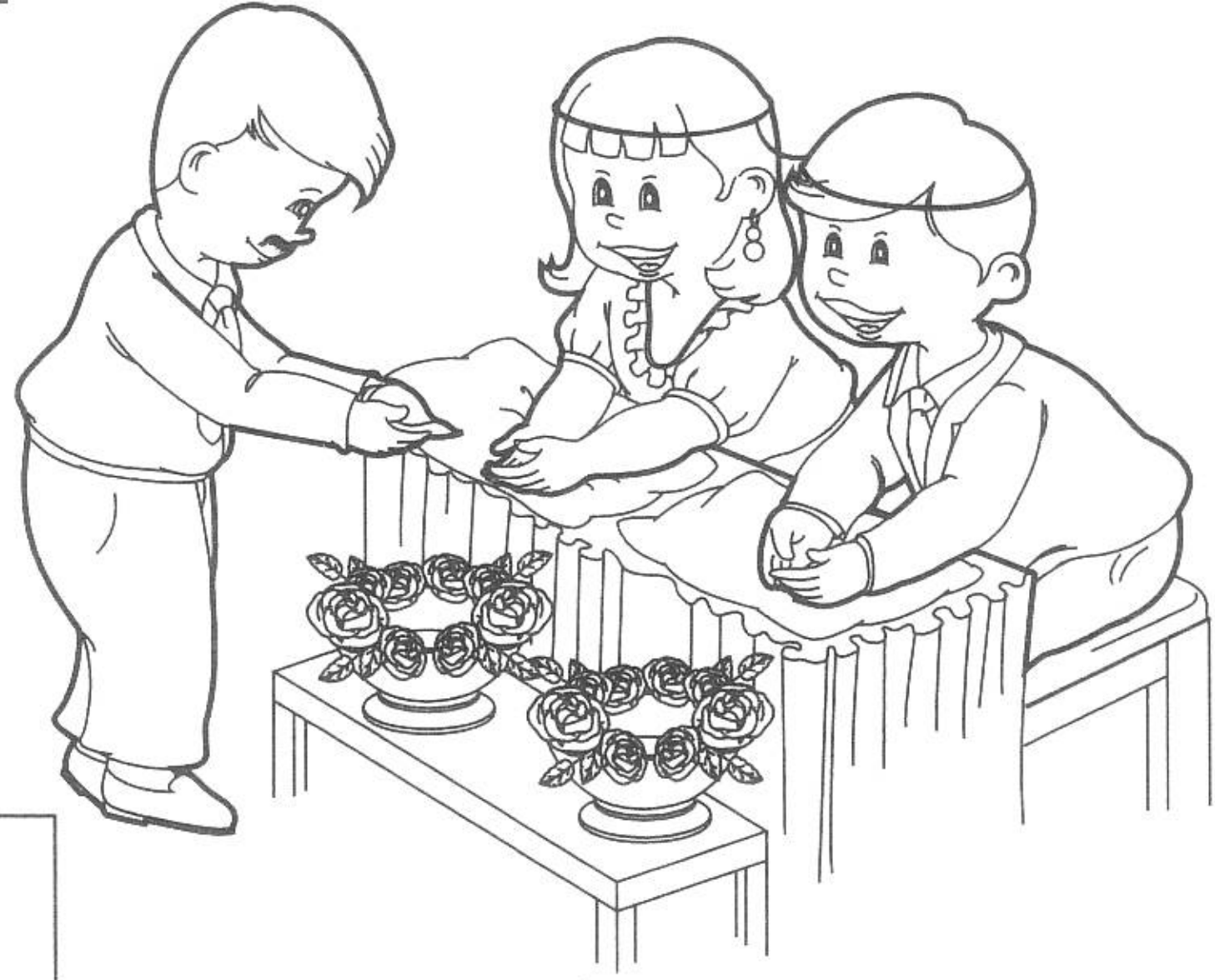

၈



၅



၆



၇

13

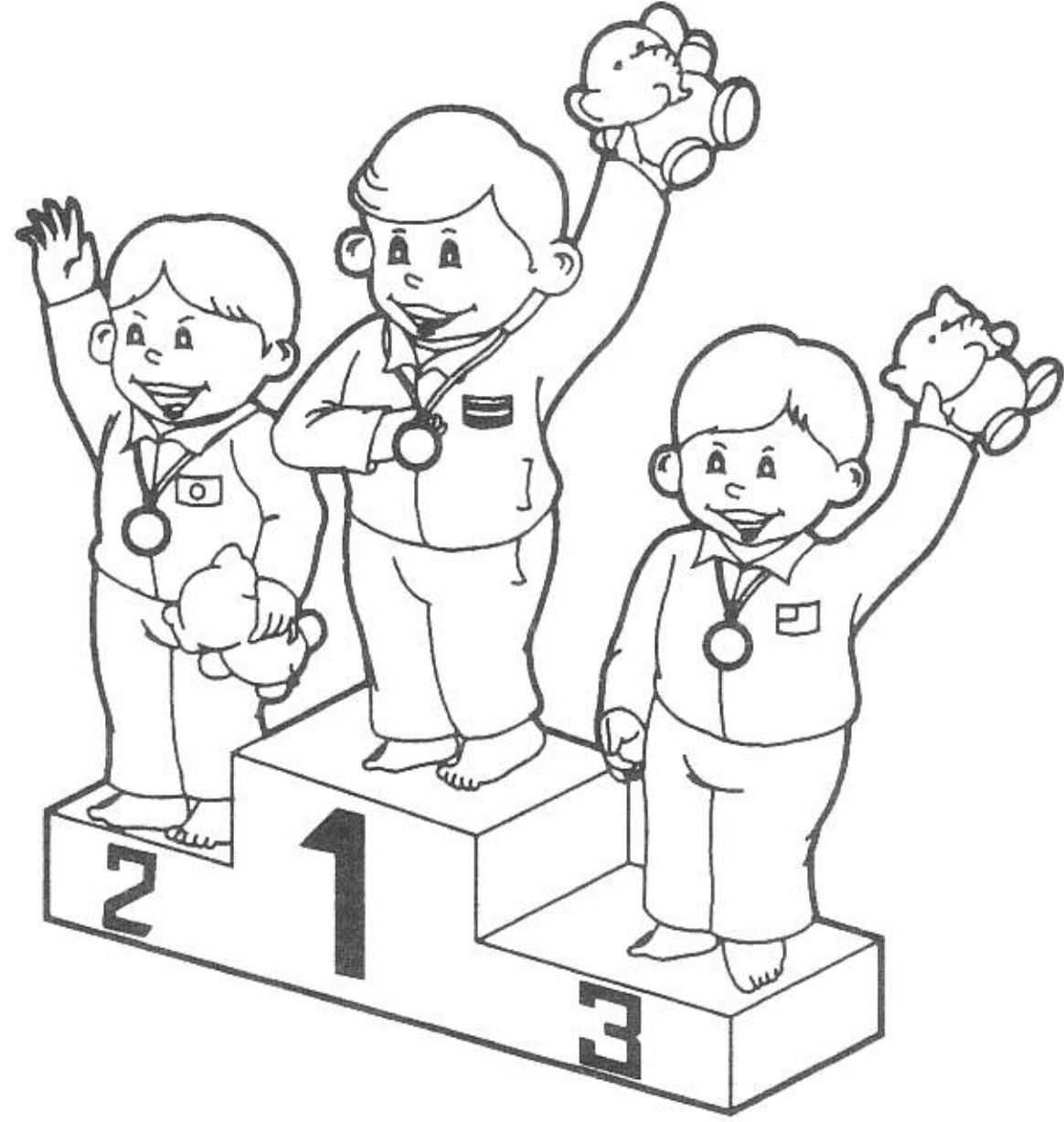

ก



ข



ค



ง

14



ก



ข



ค



ง

15



၁



၂



၃



၄

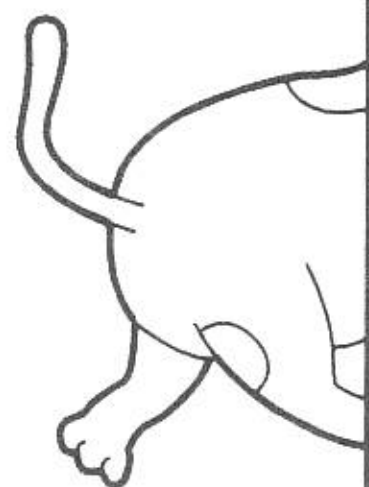

16



၁



၂



၃



၄

17



ก



ข



ค

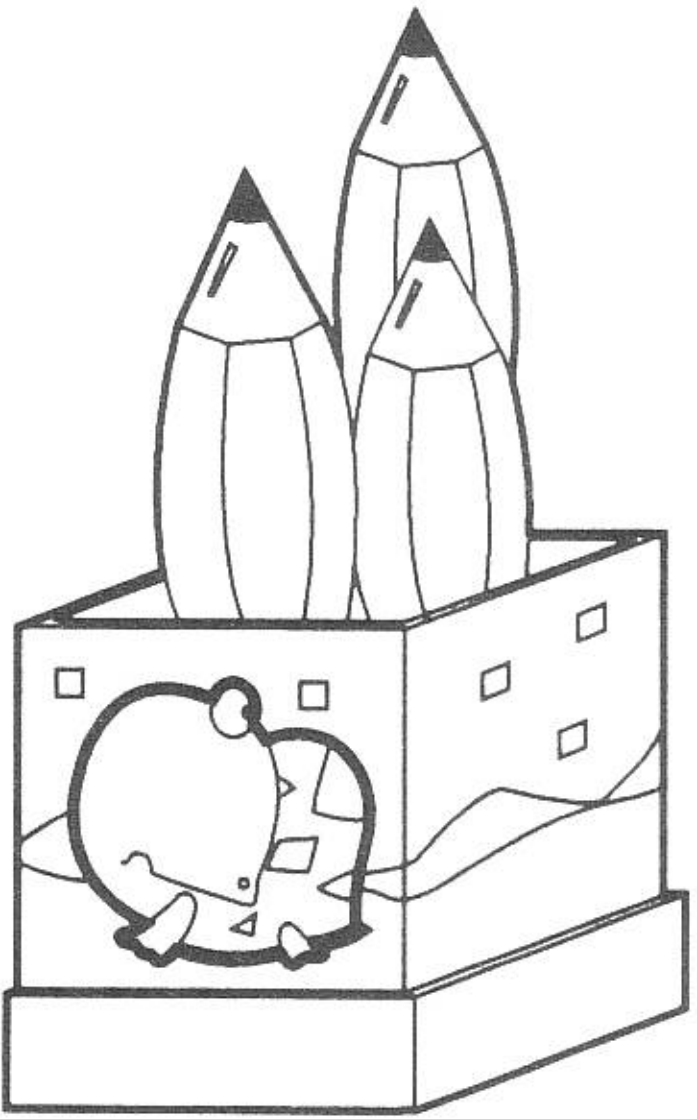

ง

18

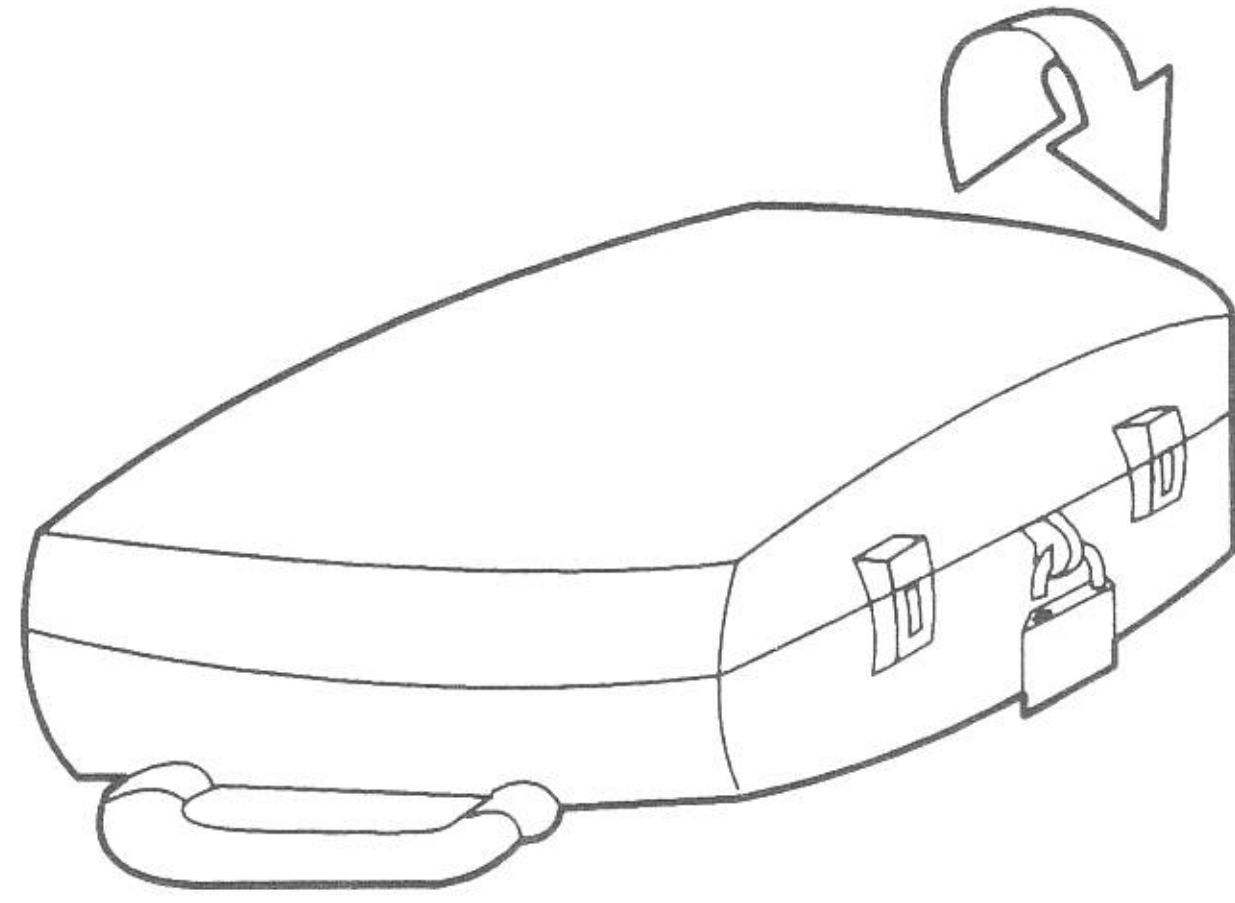

ก

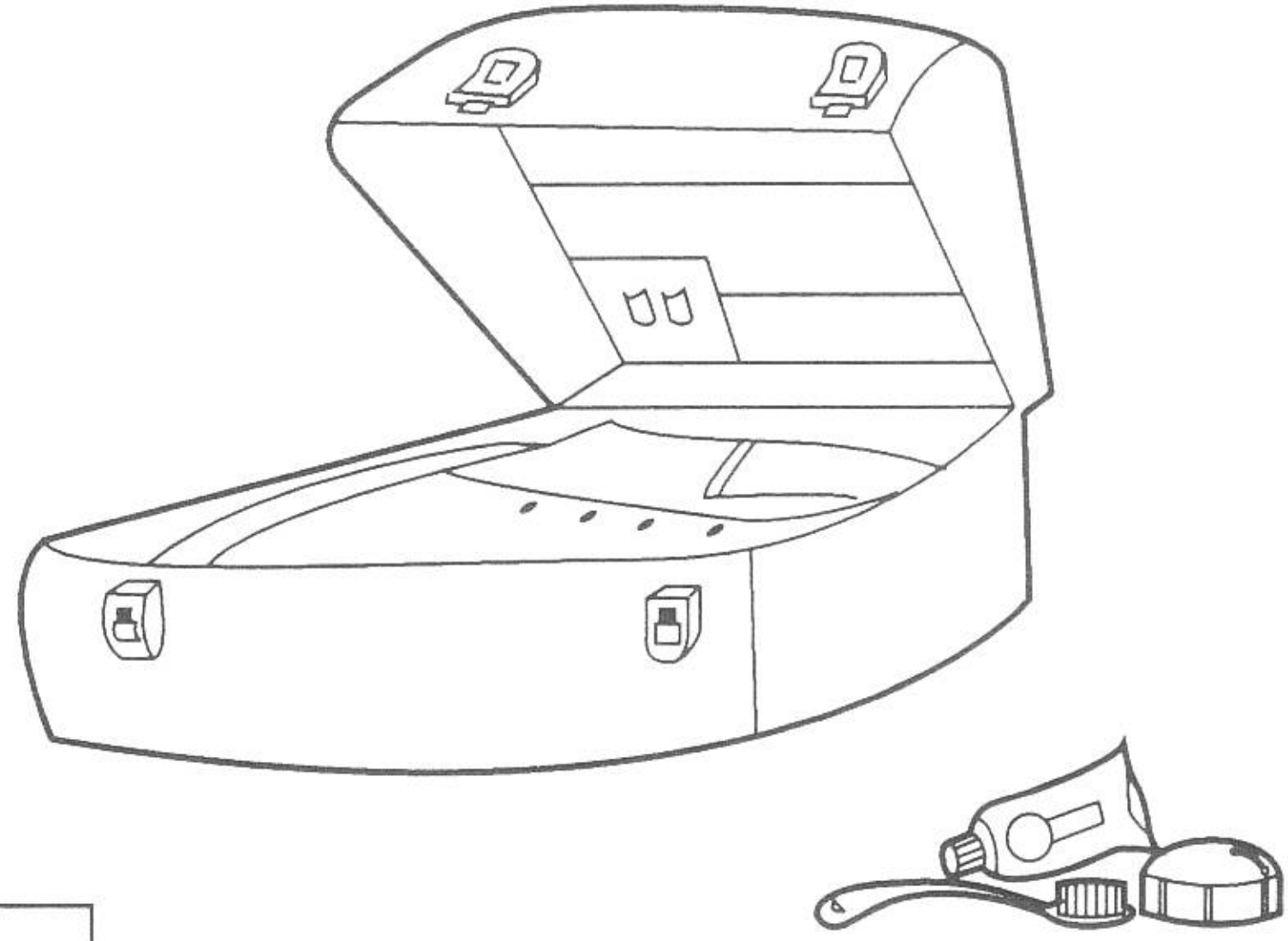

ข

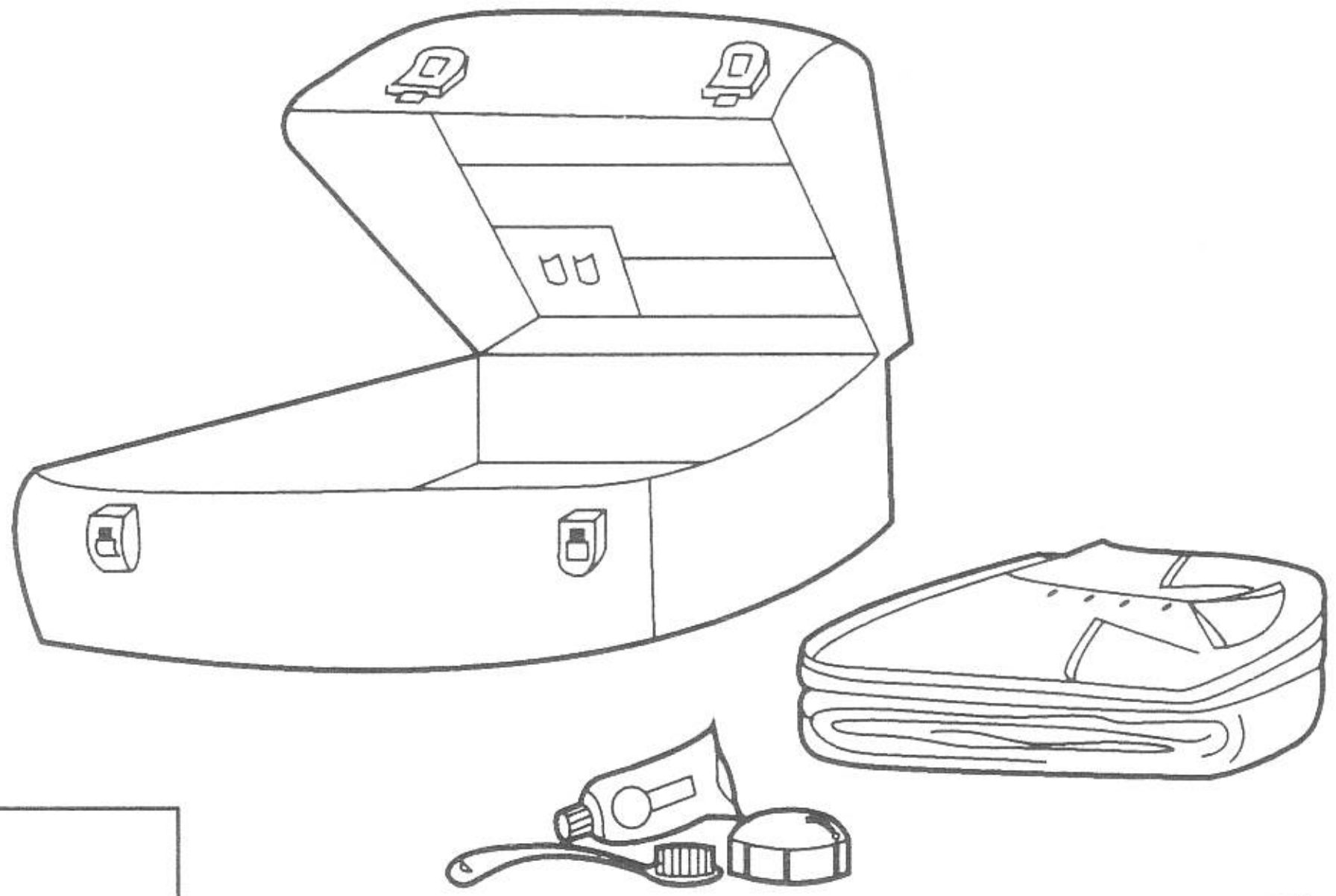

ค



ง

19



ก



ข

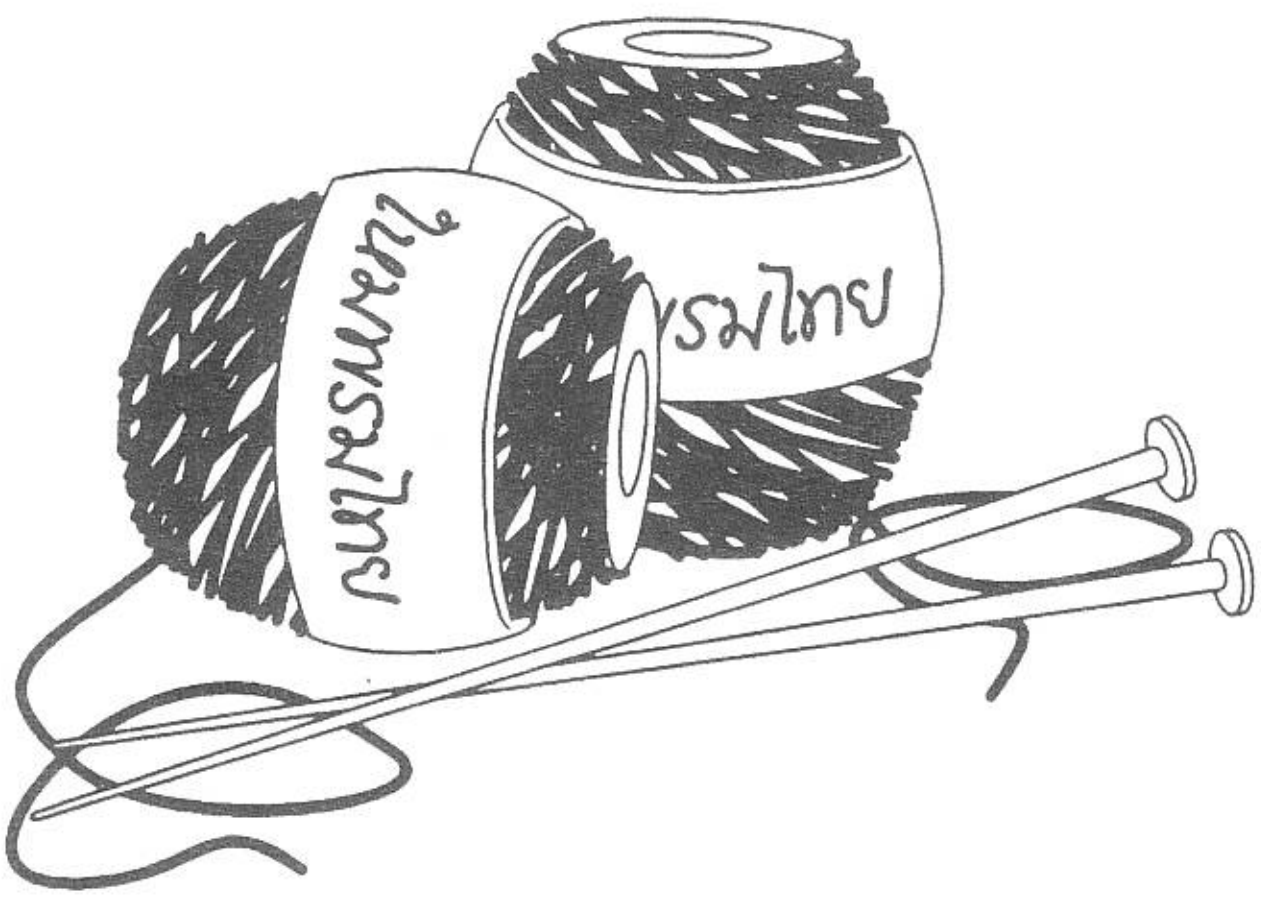

ค



ง

20

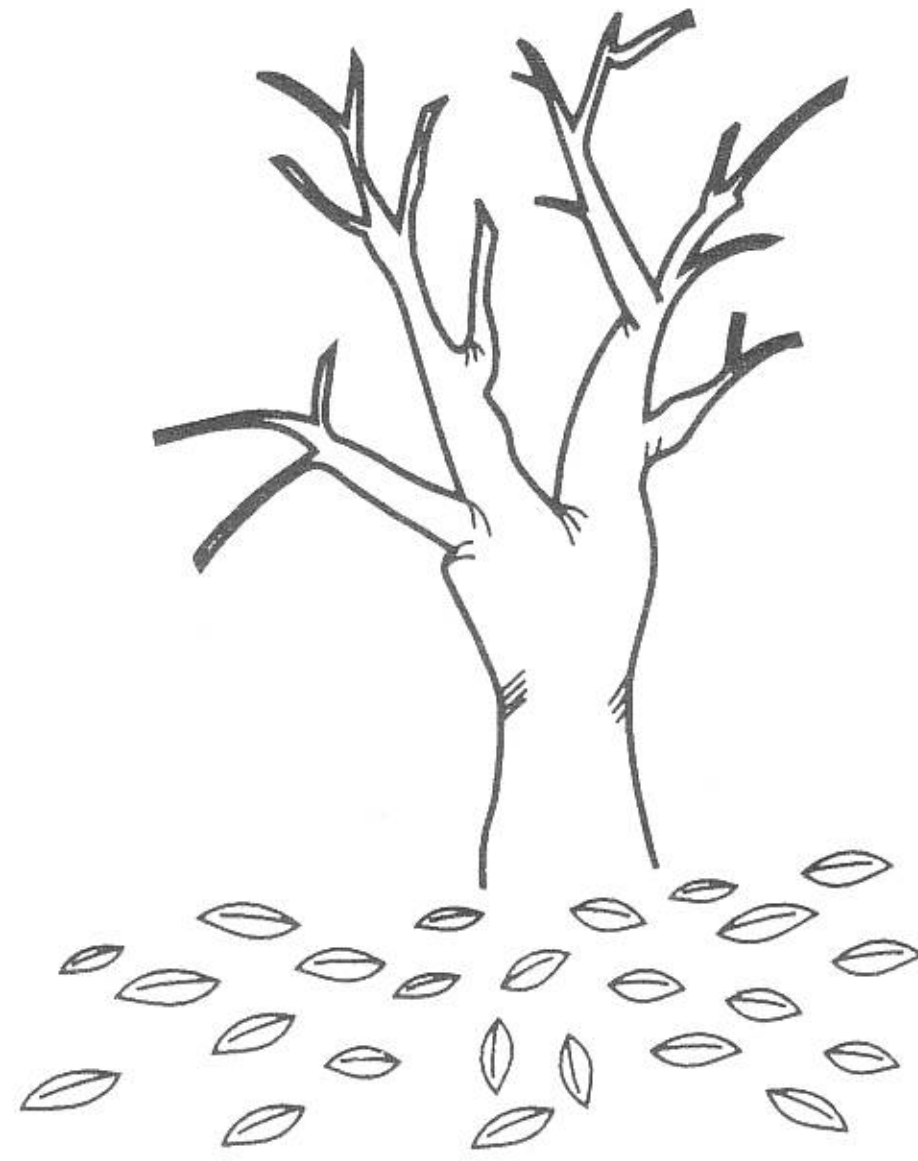

ก

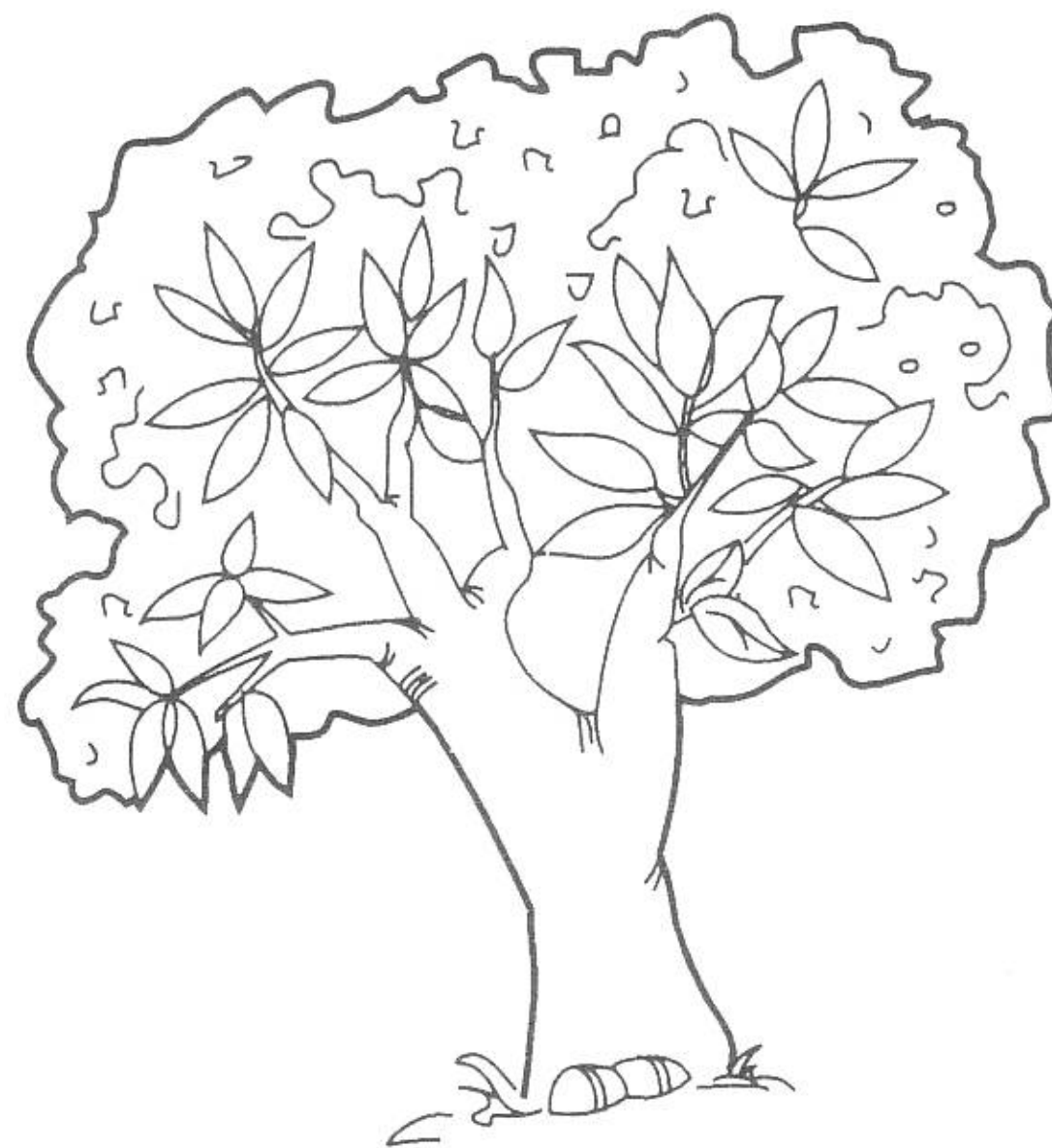

ข

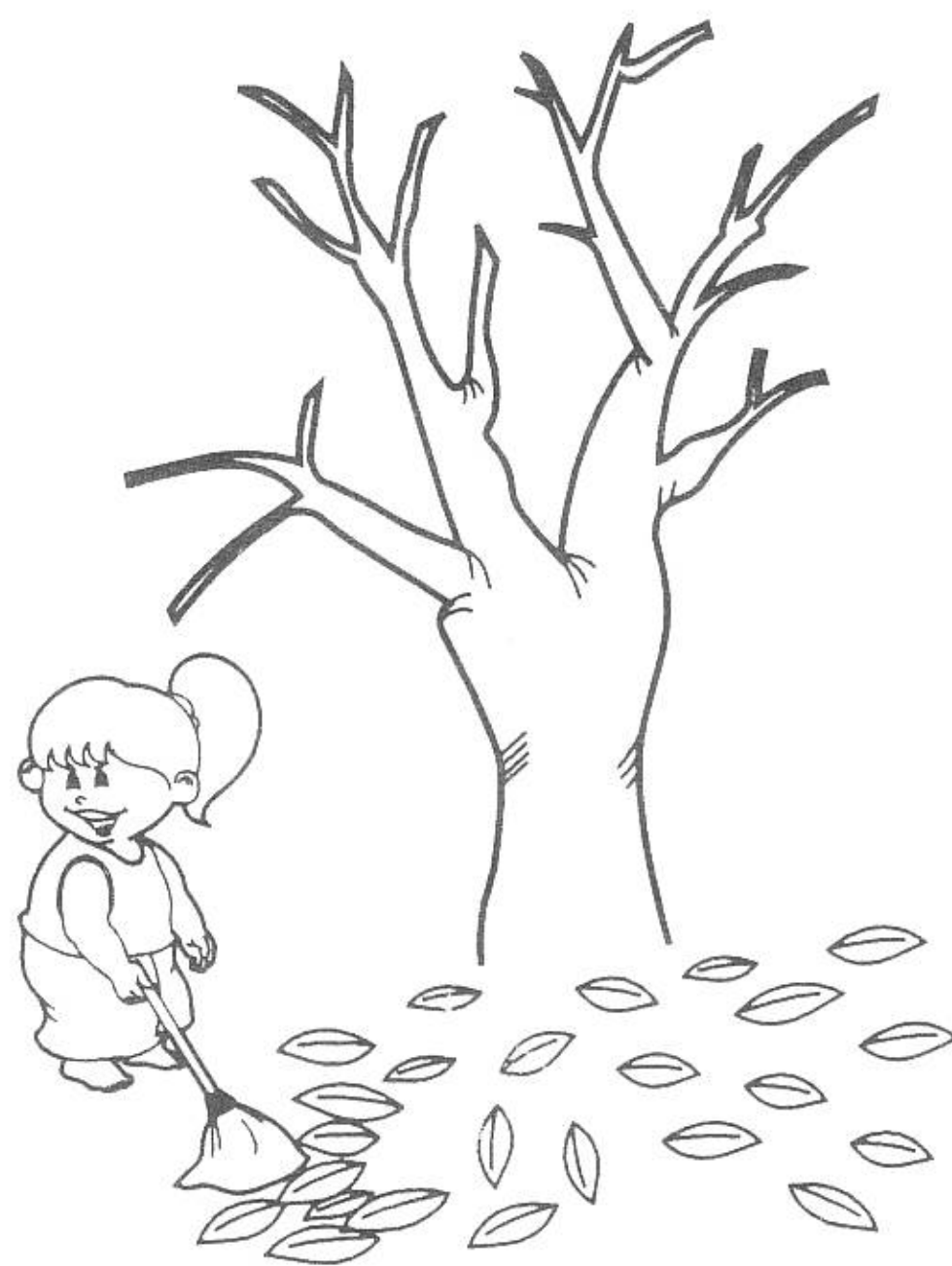

ค

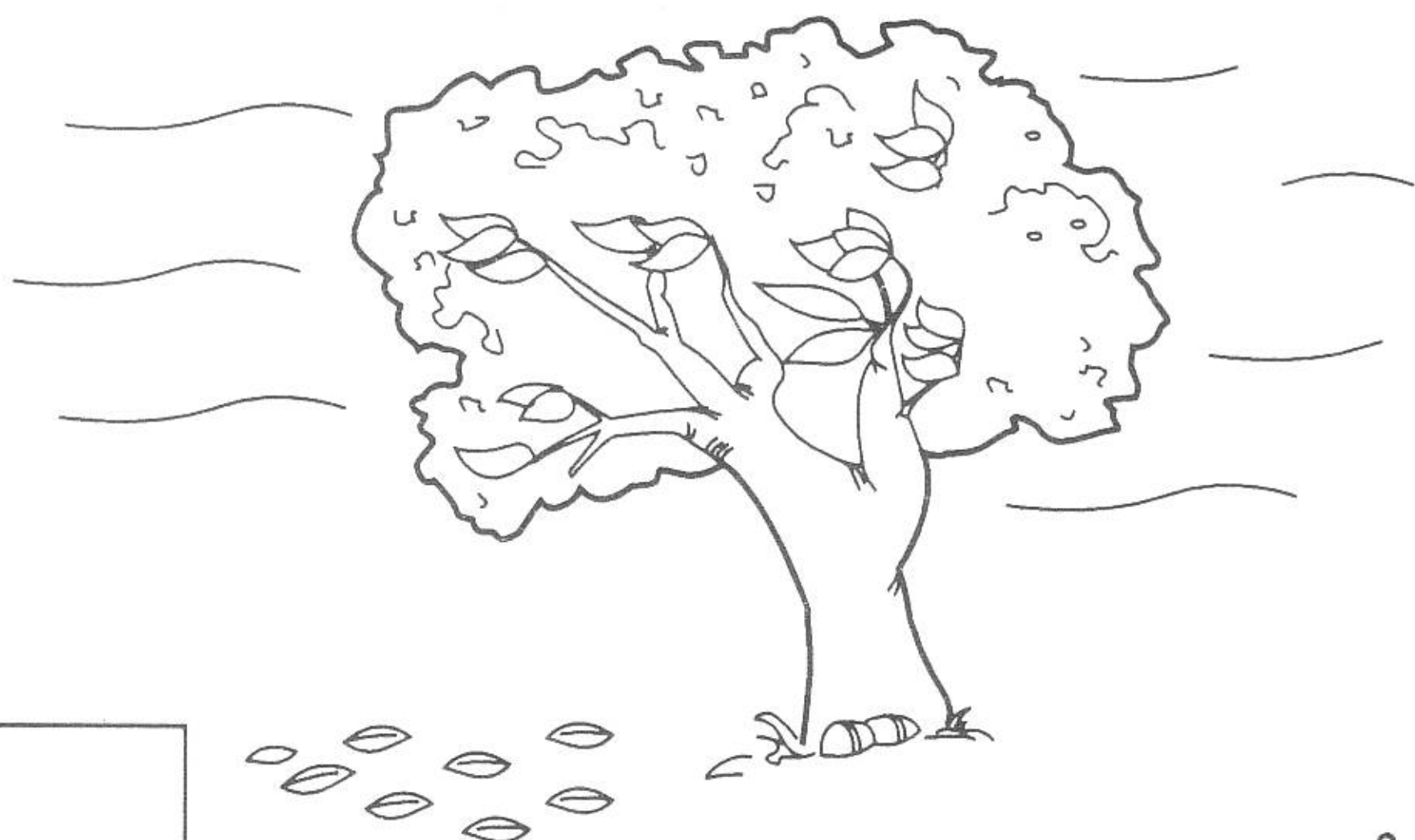

ง

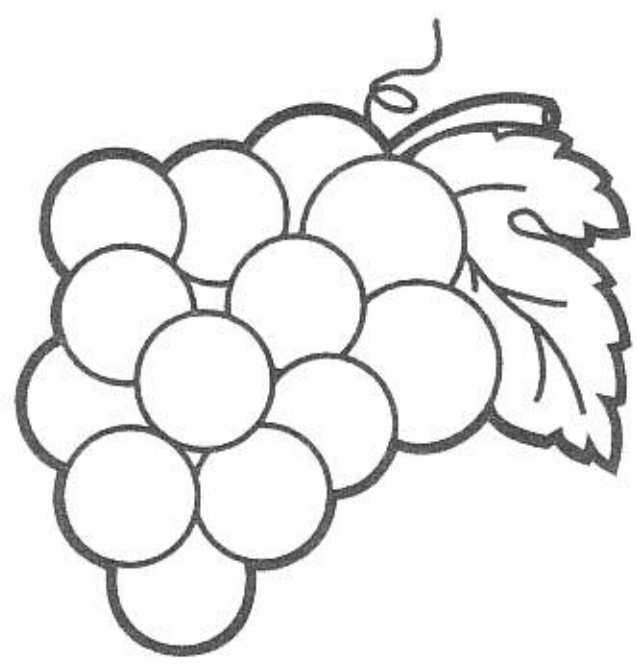

ตอนที่ 3

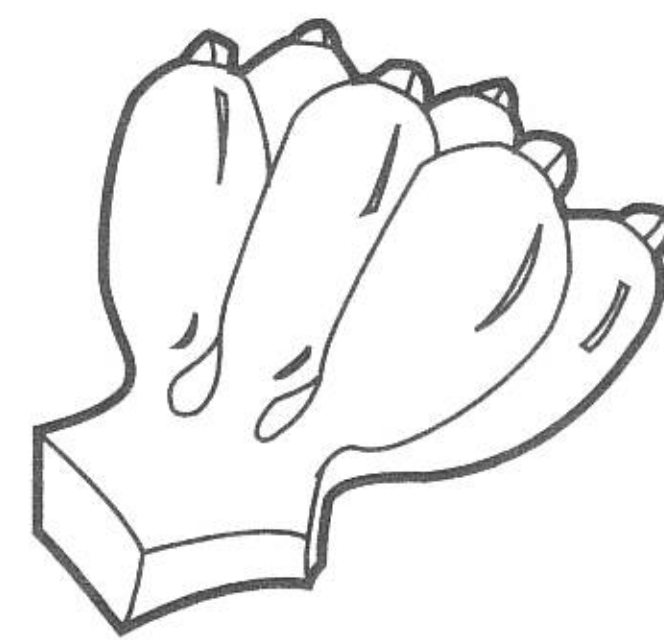

การหาภาพสมบูรณ

- ◇ การนำภาพมาประกอบให้ได้ภาพตามแบบ 20 ข้อ
- ◇ การต่อลายไม้บล็อก 24 ข้อ
- ◇ การหาภาพที่มีลายเข้าชุดกับภาพที่กำหนด 20 ข้อ
- ◇ การหาภาพที่ซ่อนในภาพที่กำหนด 20 ข้อ
- ◇ การหาภาพที่เกิดจากการรวมกันของภาพที่กำหนด 16 ข้อ



จงขีด ✓ ภาพที่นำมาประกอบแล้วได้ภาพตามแบบที่กำหนดให้

1

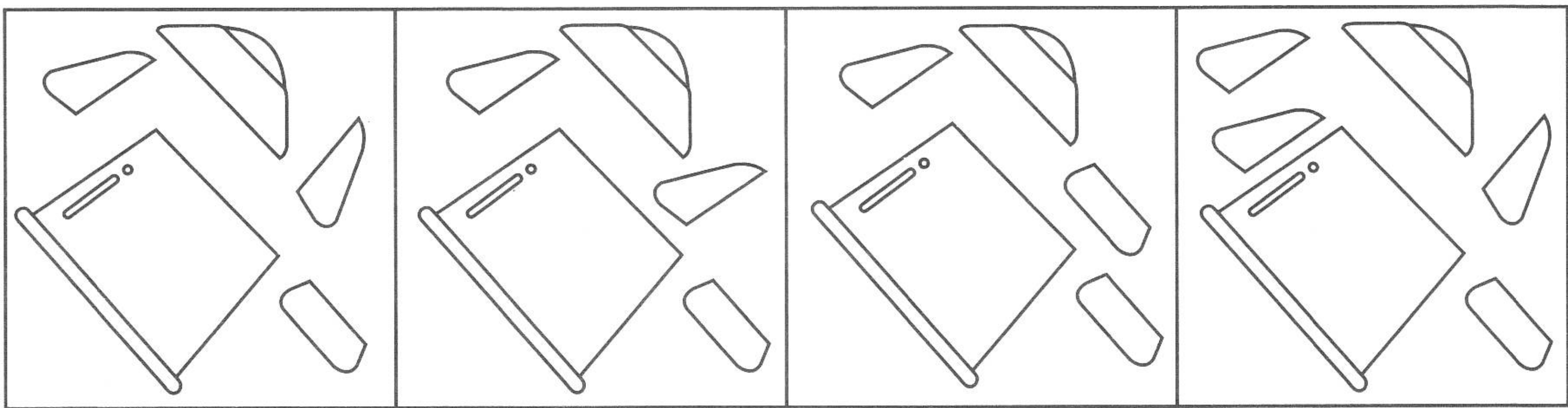
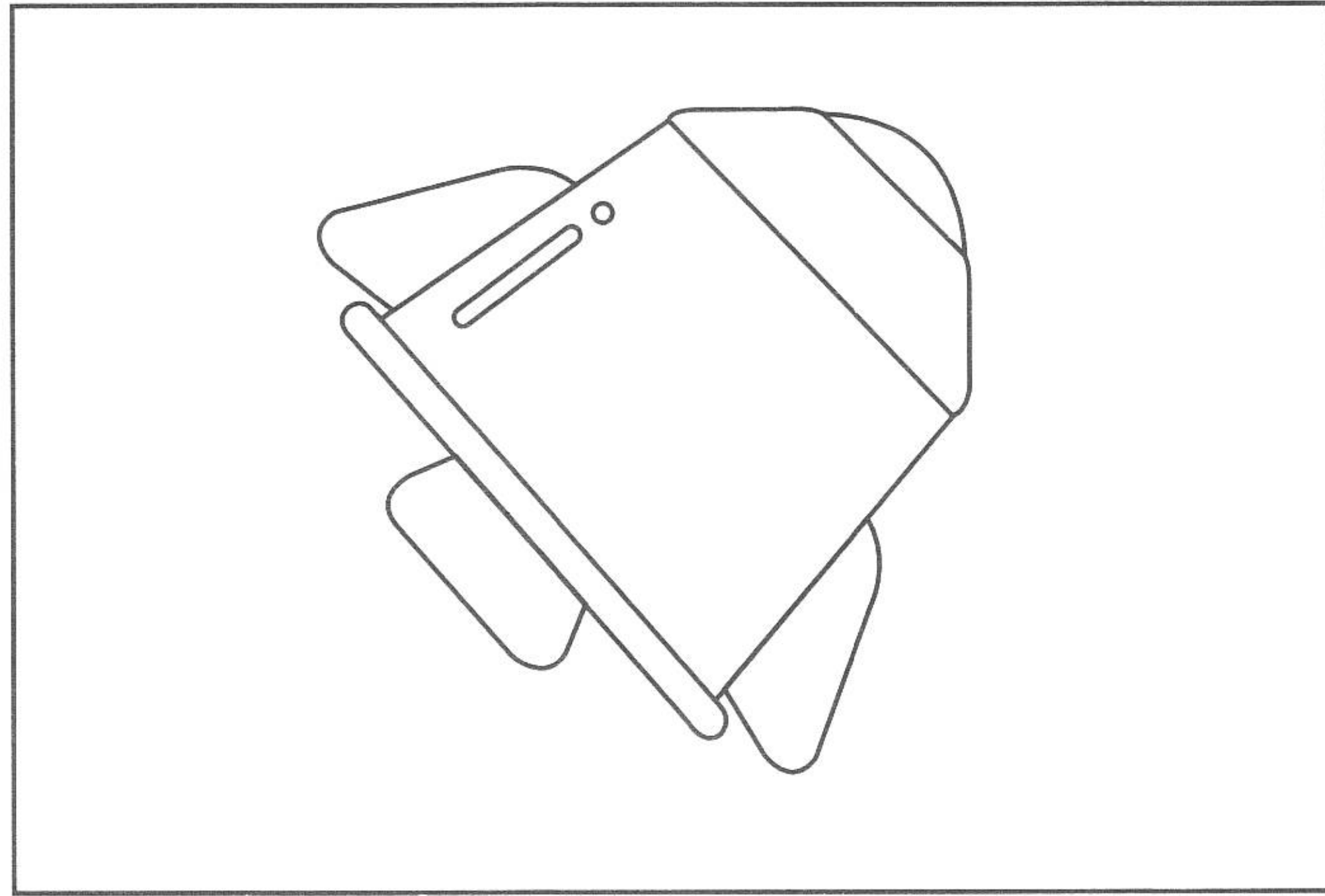

ก

ข

ค

ง

2

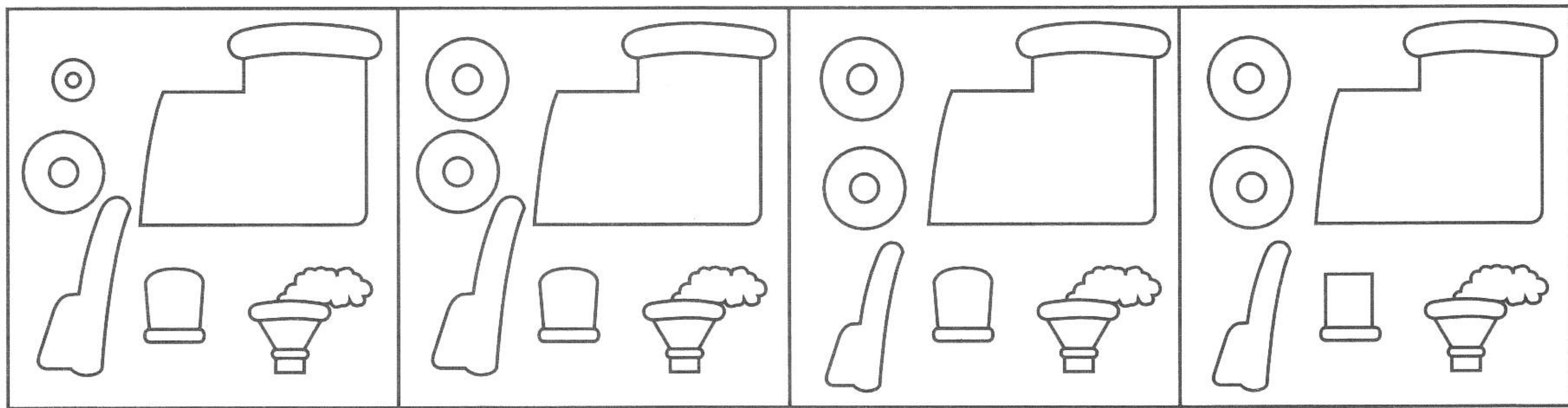
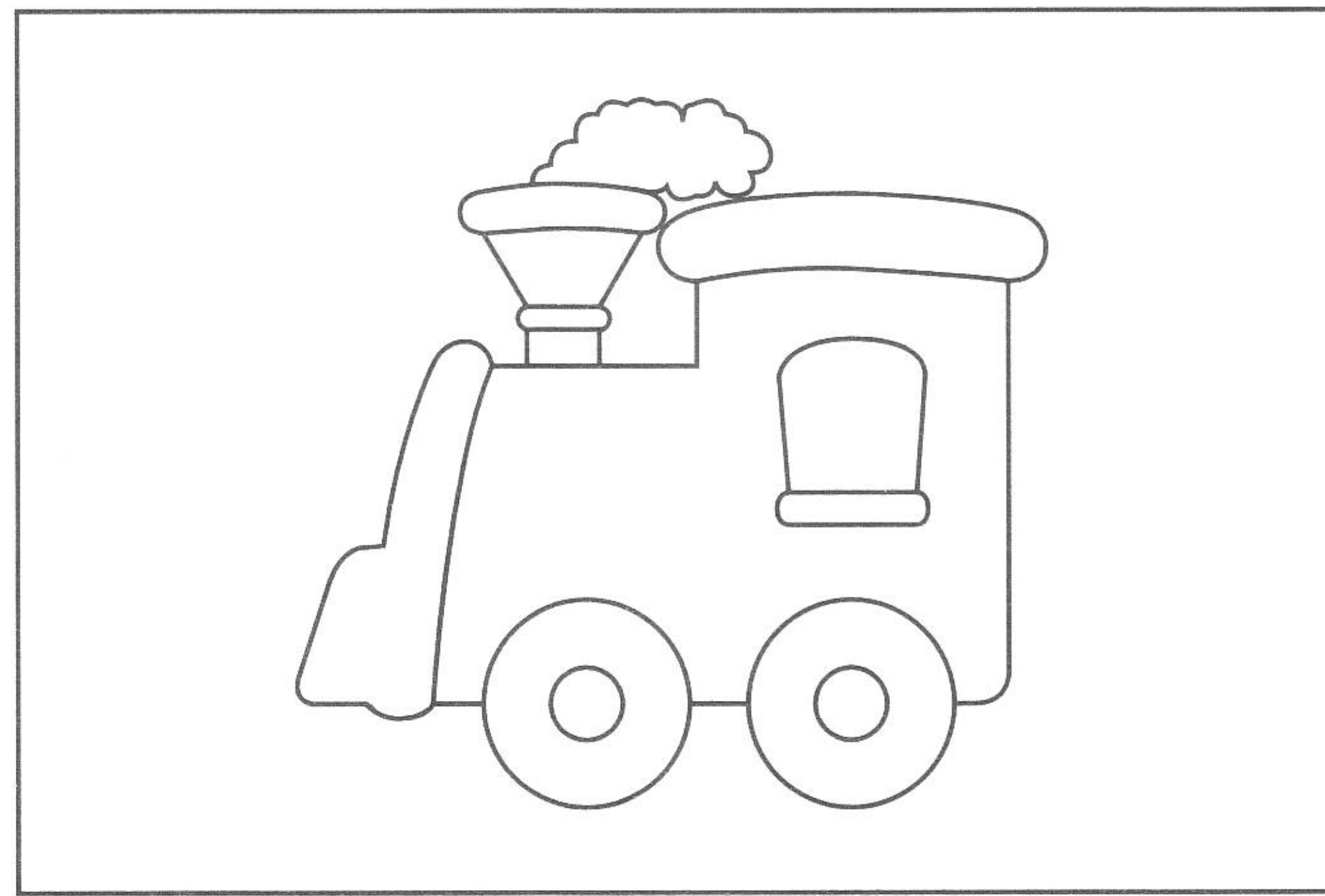

ก

ข

ค

ง

3

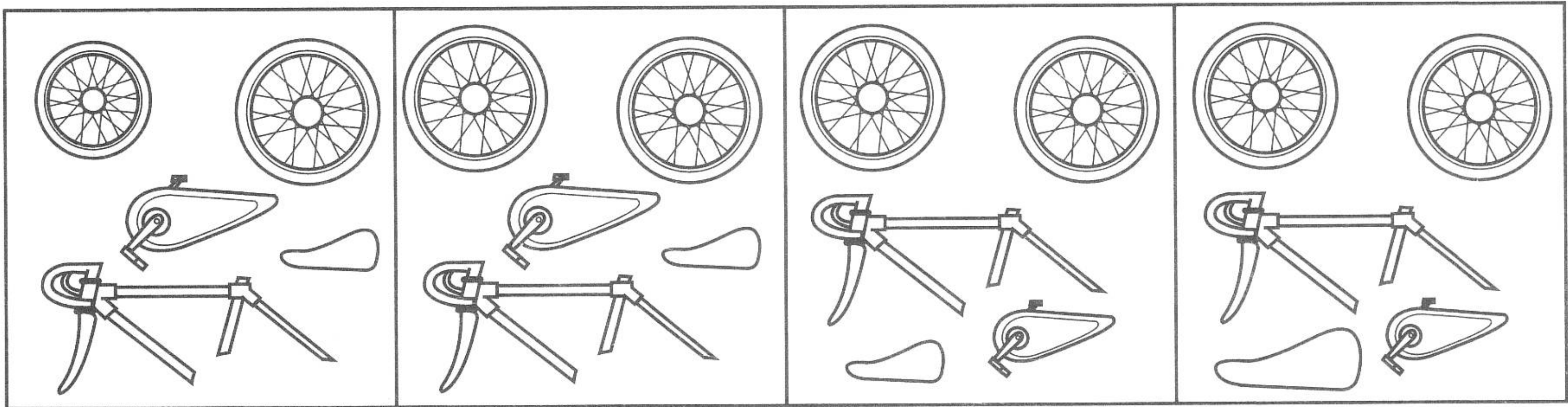
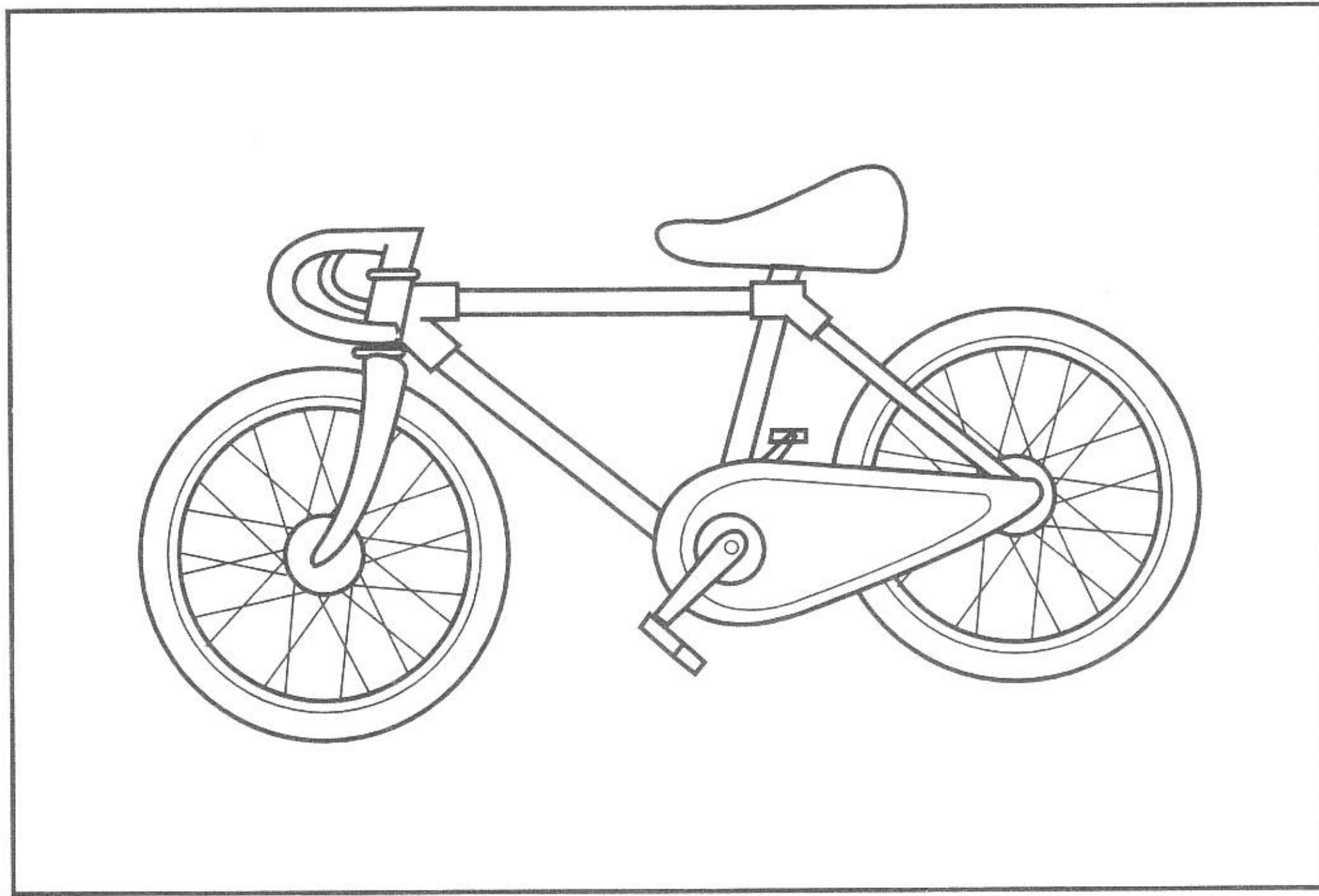

ก

ข

ค

ง

4

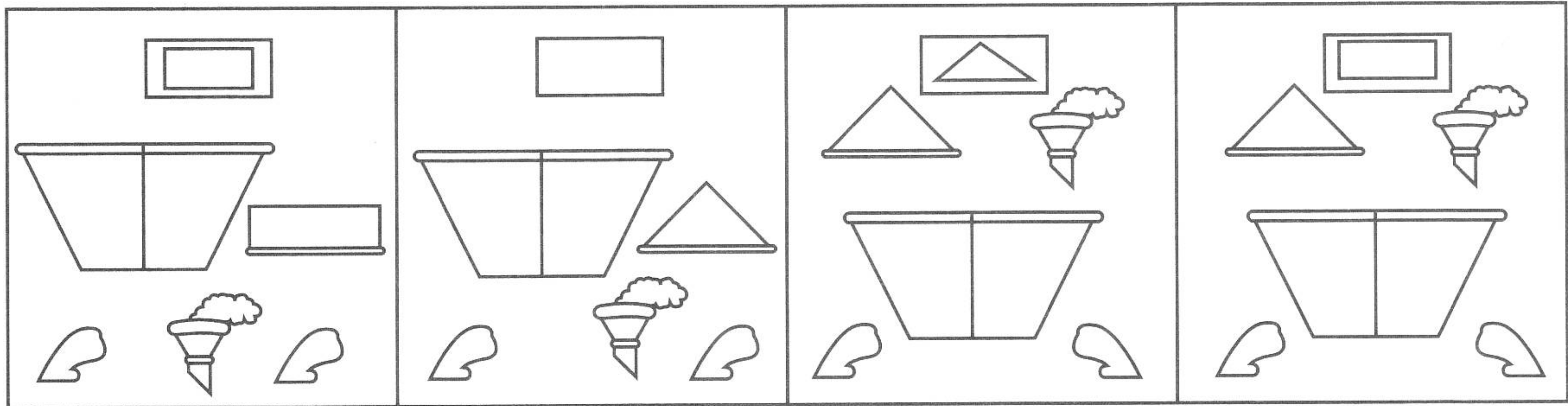
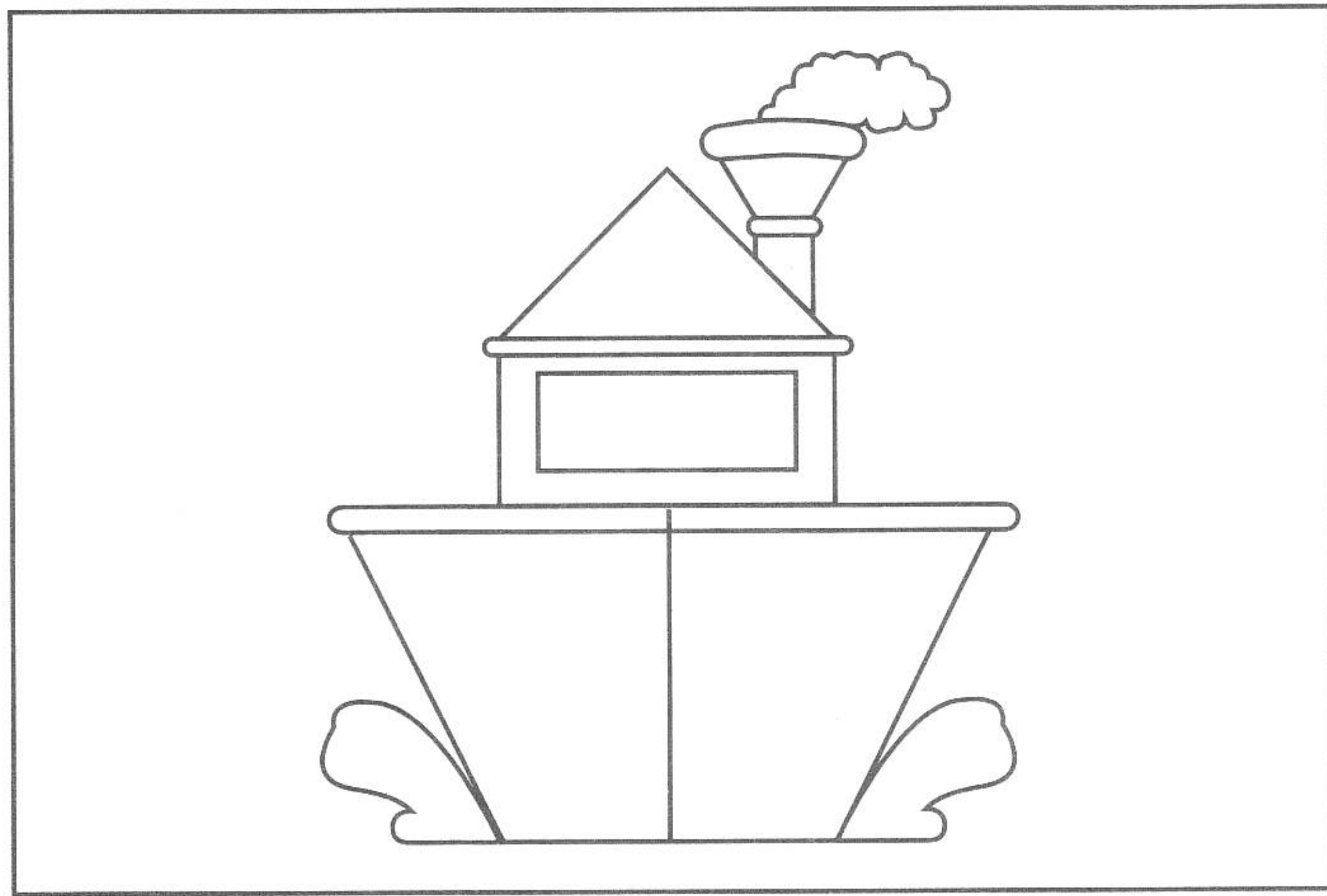

ก

ข

ค

ง

5

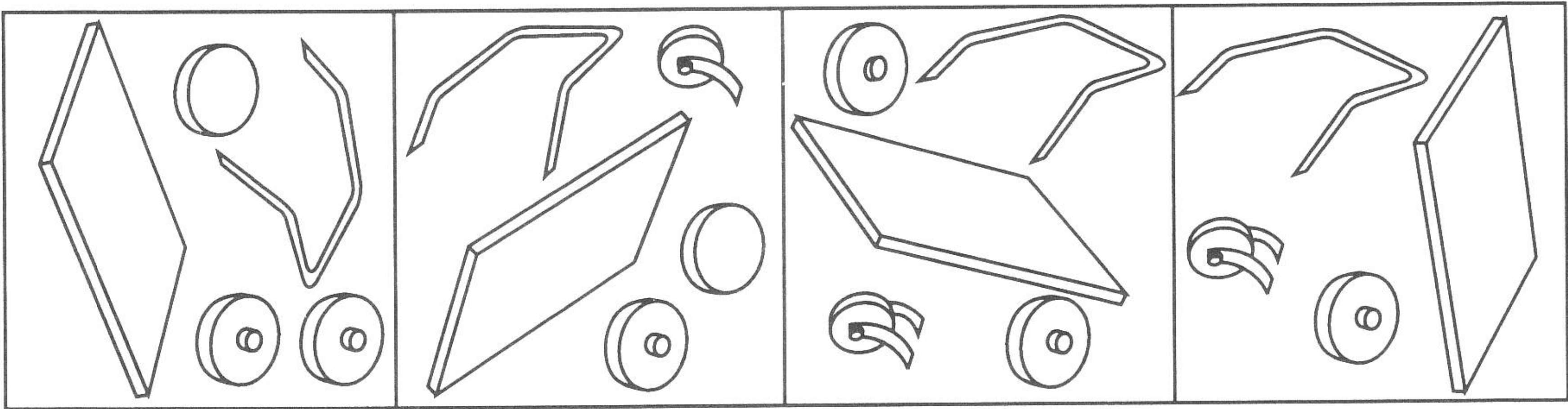
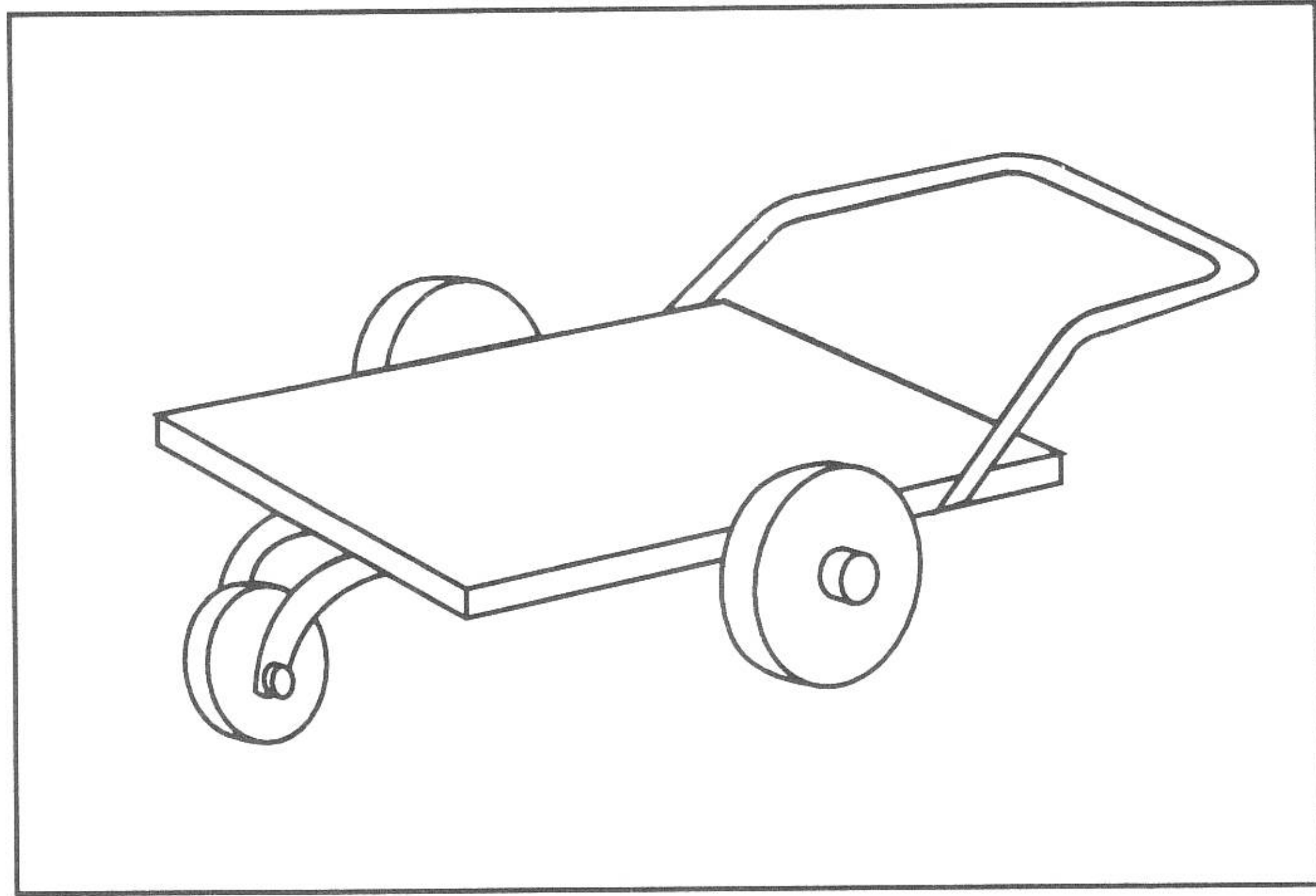

ก

ข

ค

ง

6

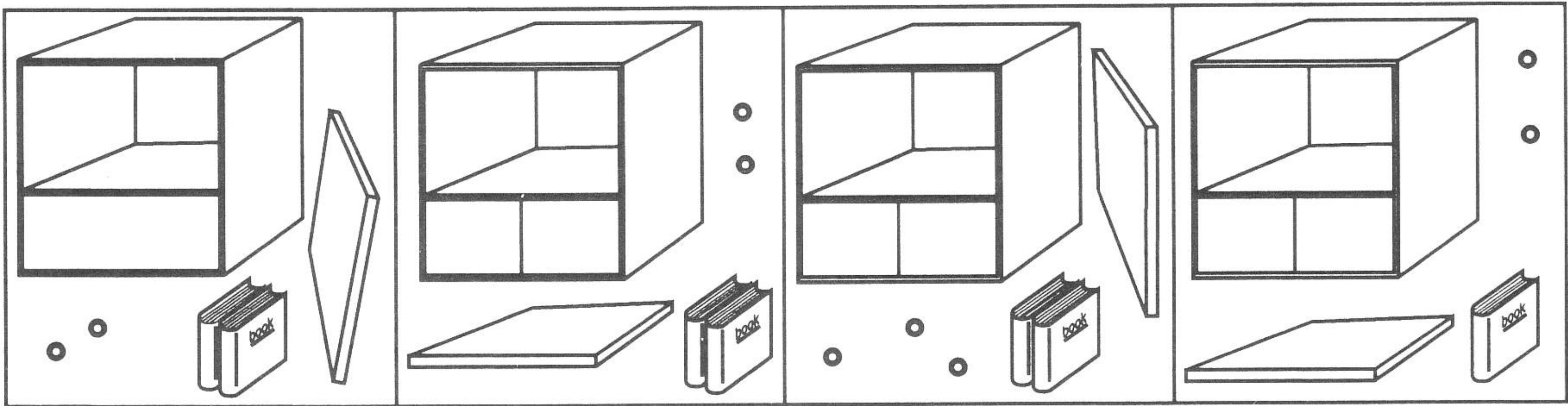
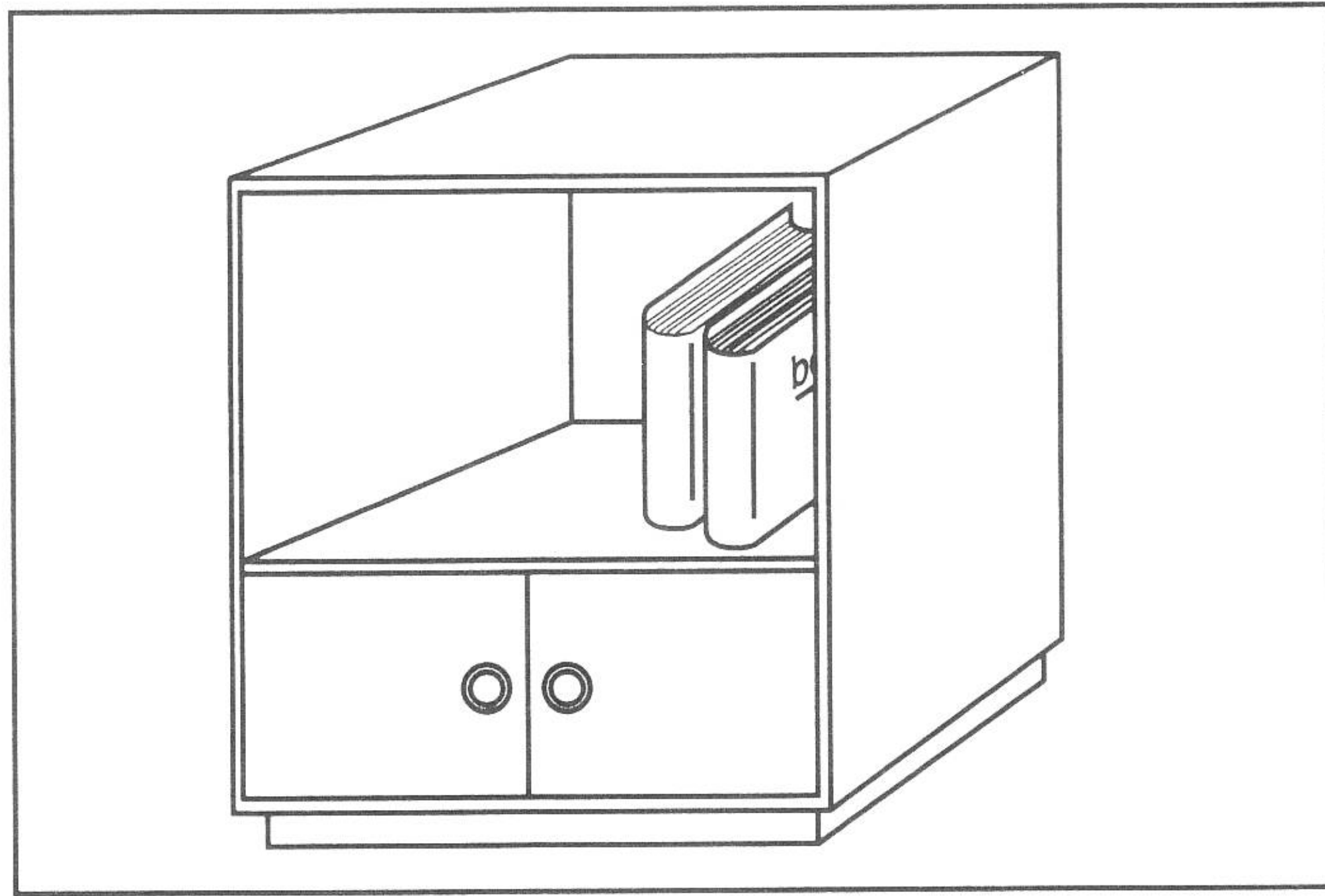

ก

ข

ค

ง

7

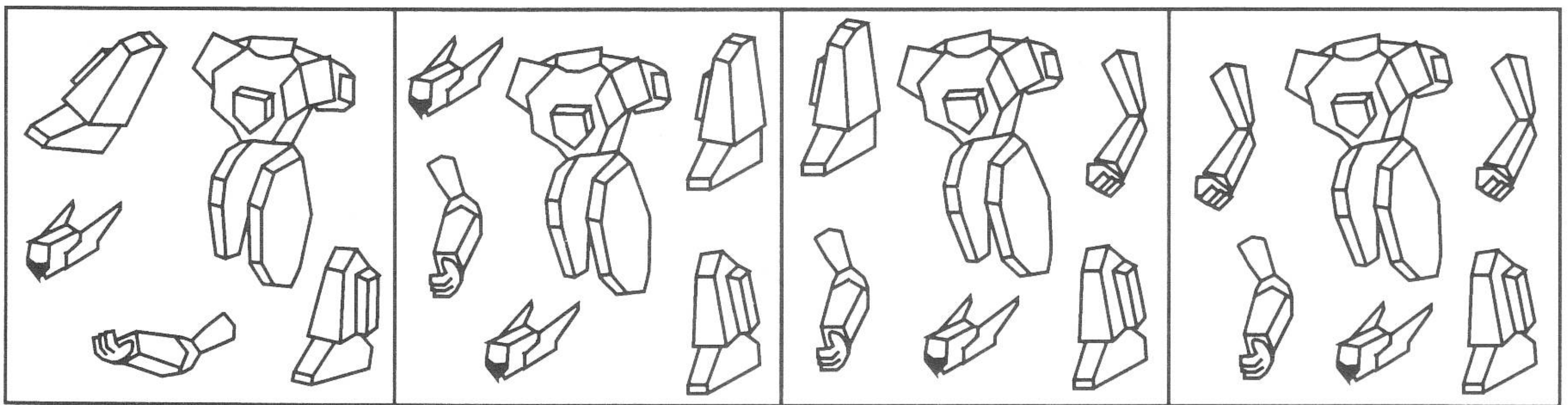
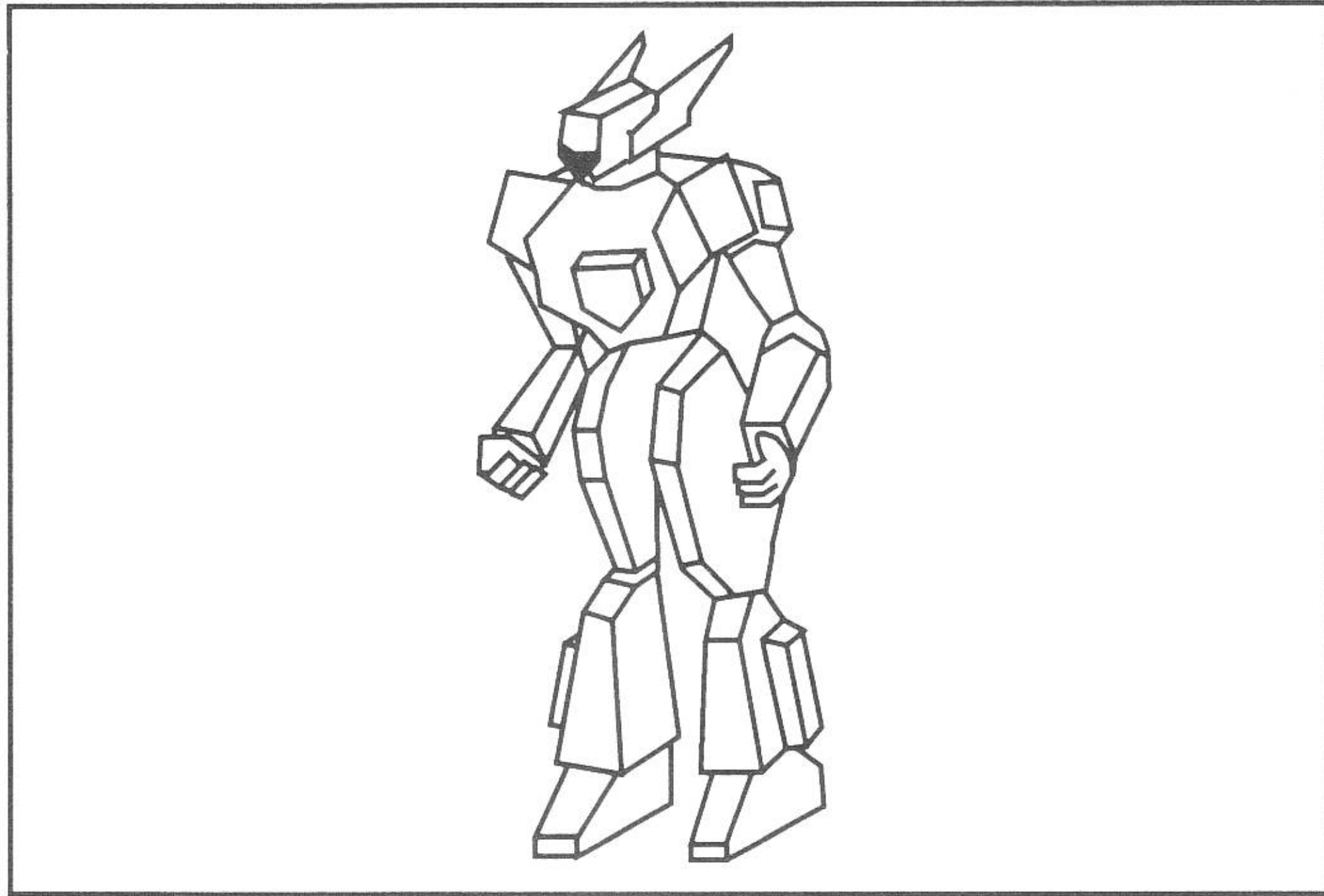

ก

ข

ค

ง

8

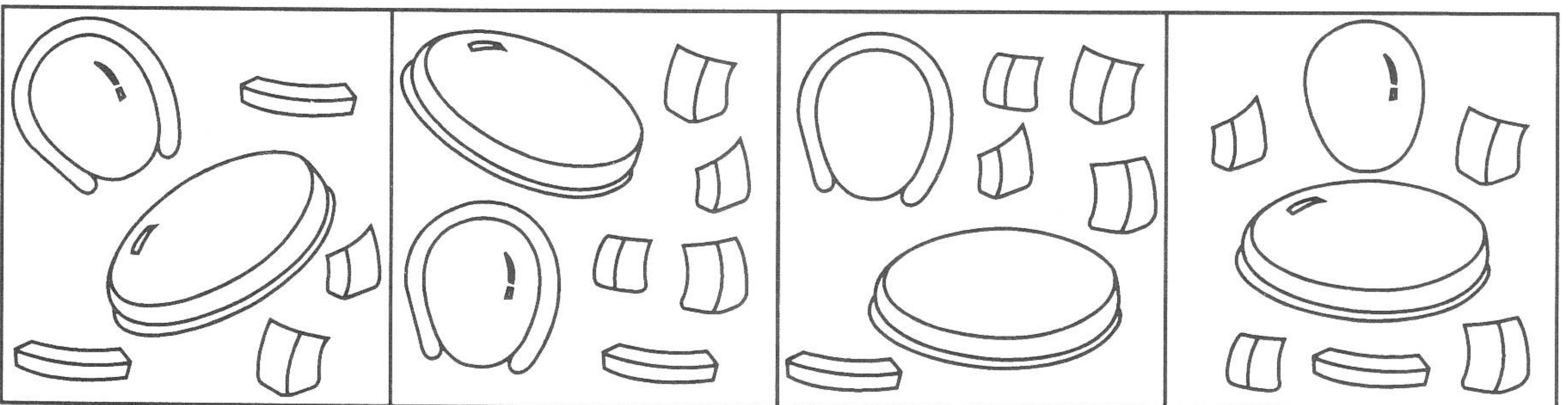
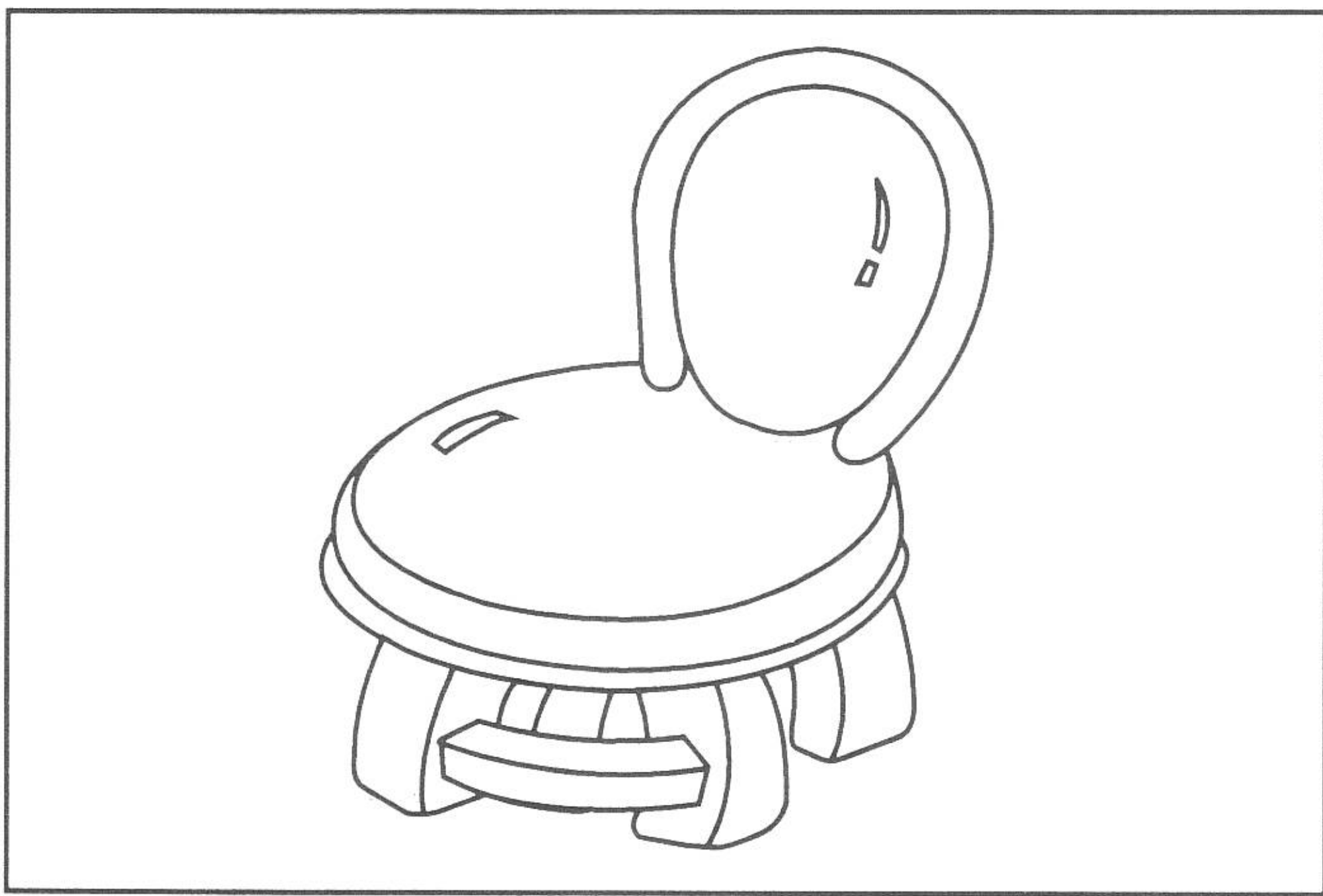

ก

ข

ค

ง

9

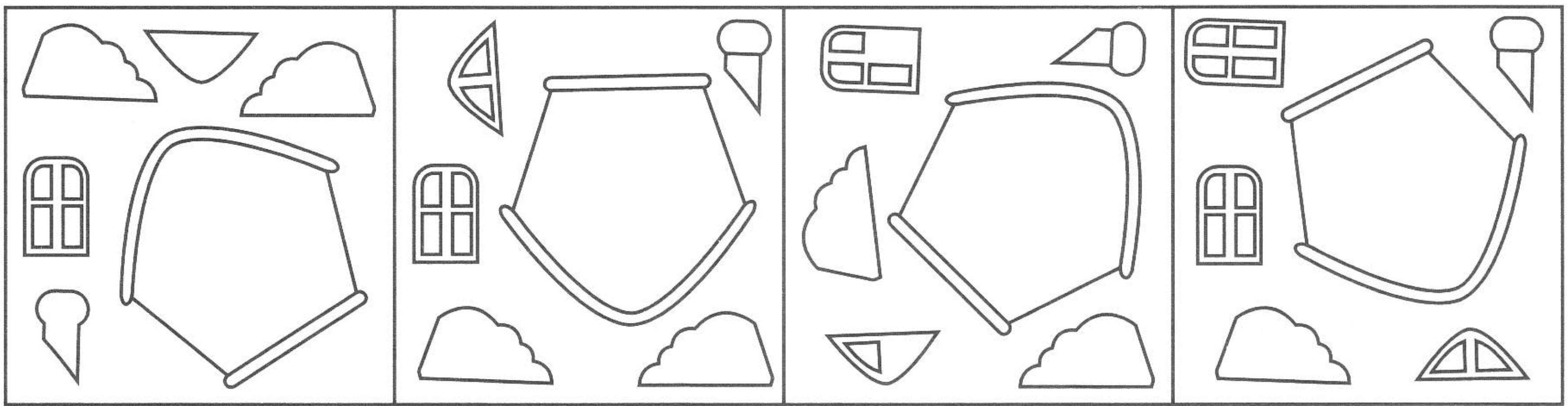
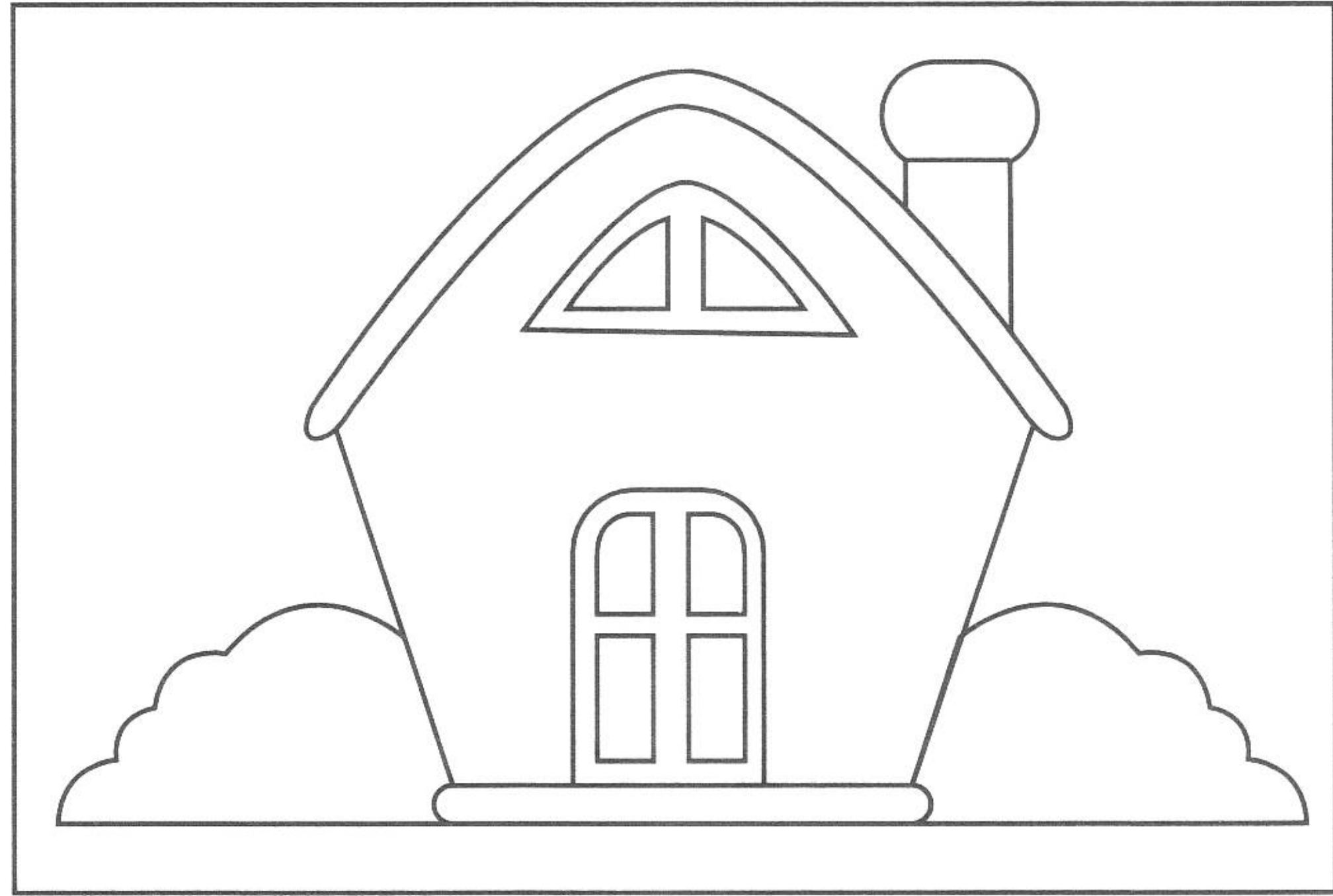

ก

ข

ค

ง

10

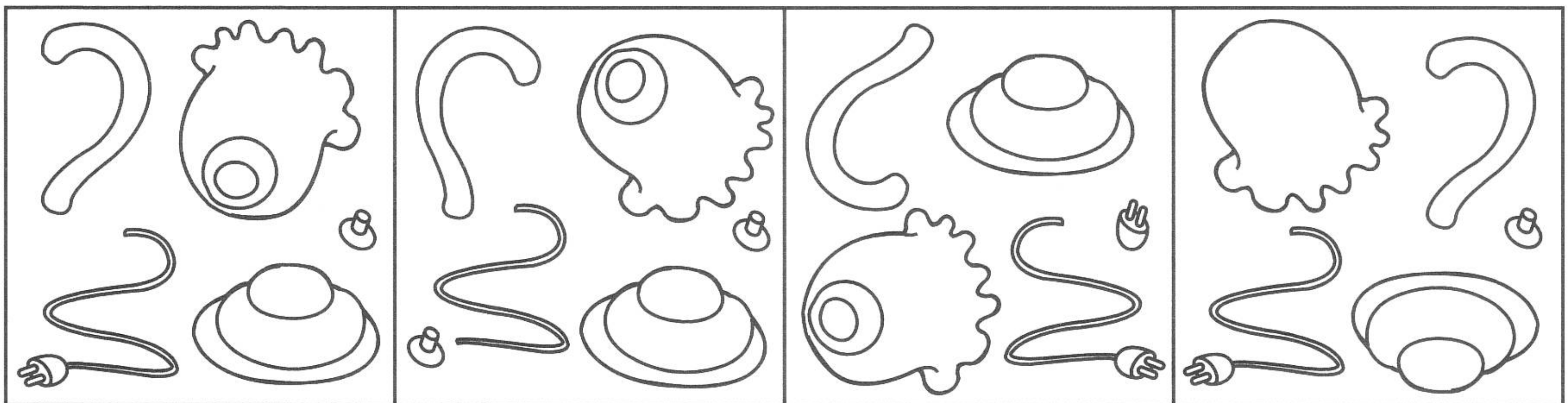
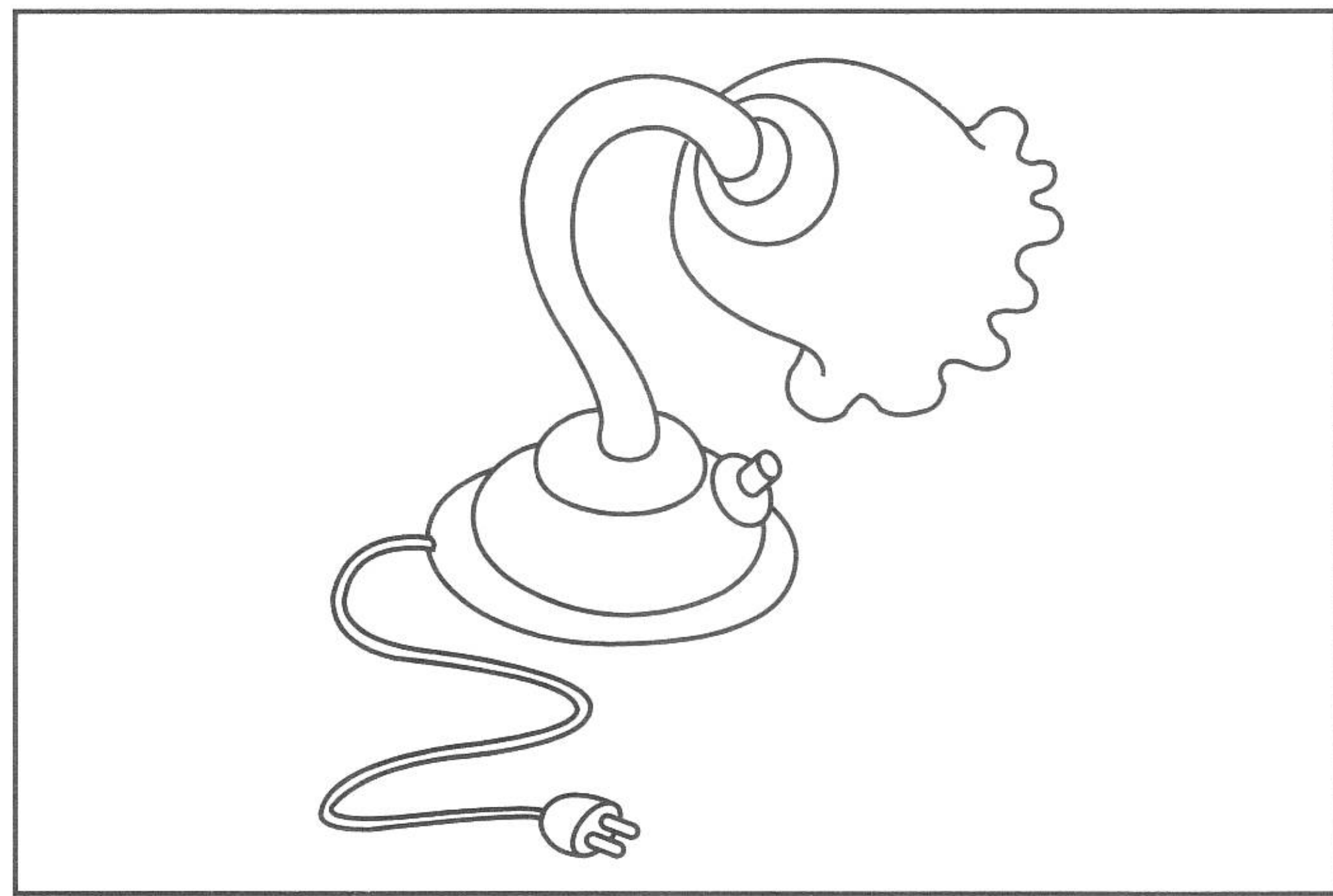

ก

ข

ค

ง

11

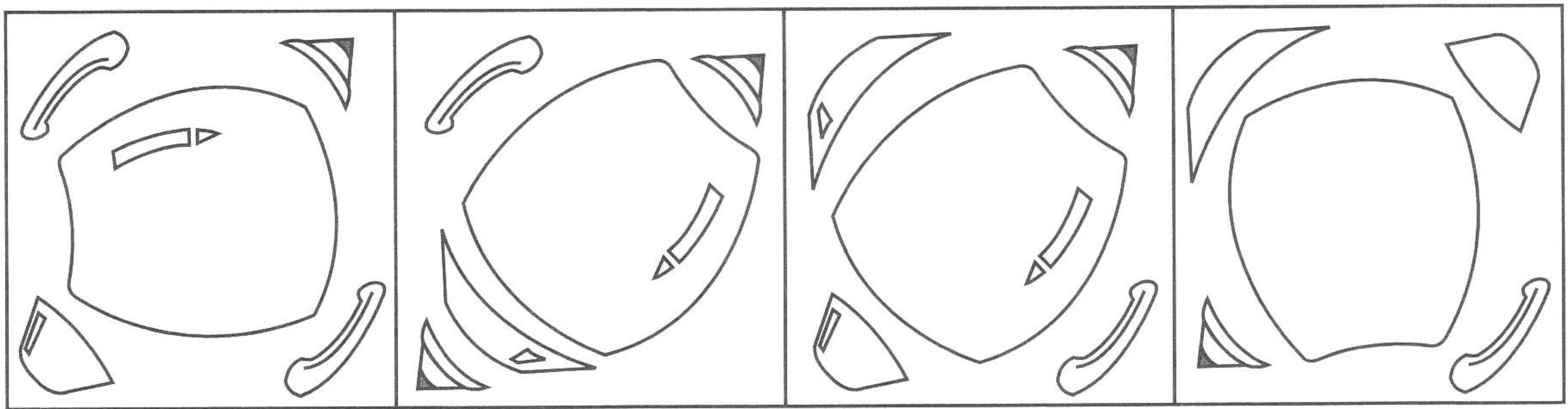
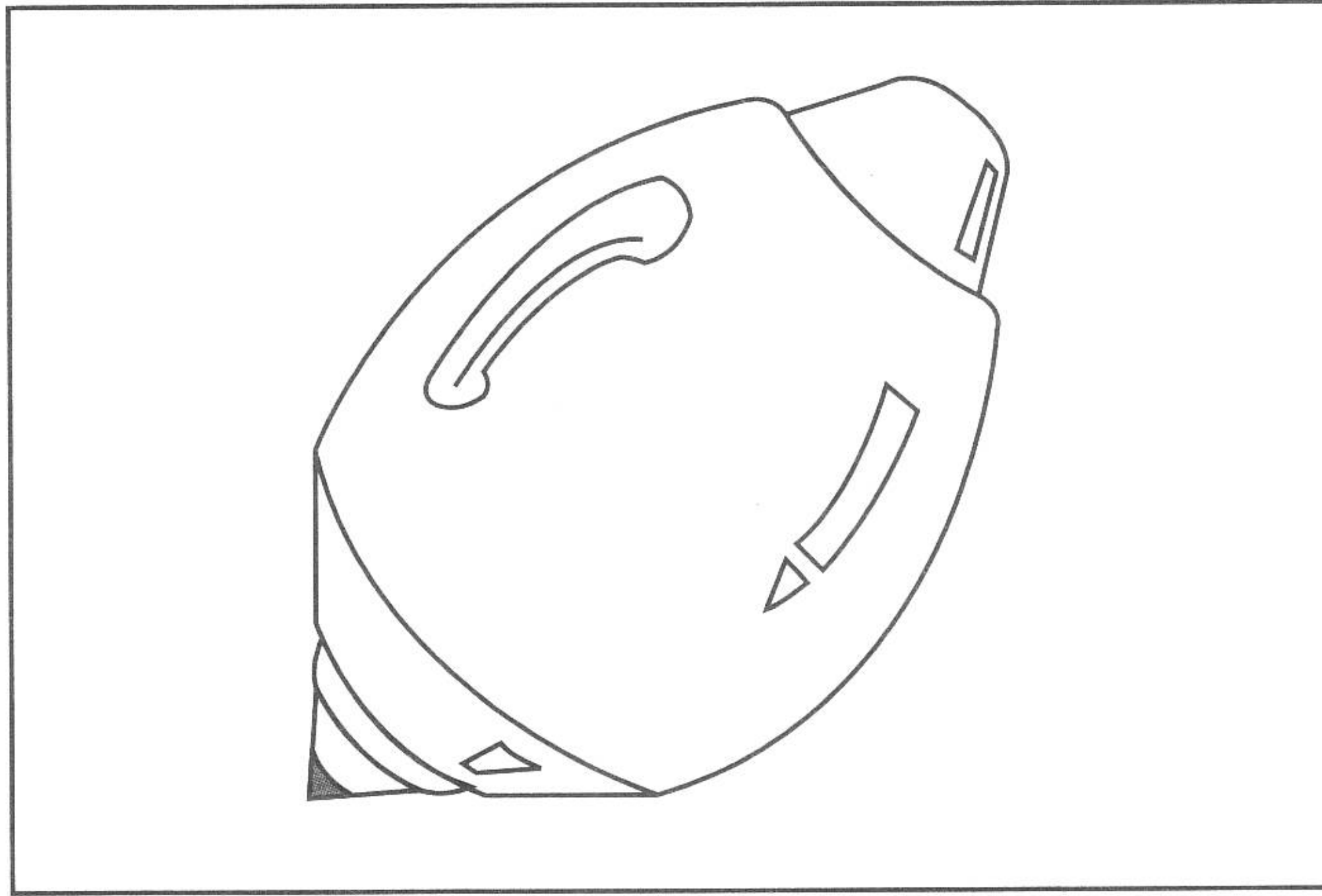

ก

ข

ค

ง

12

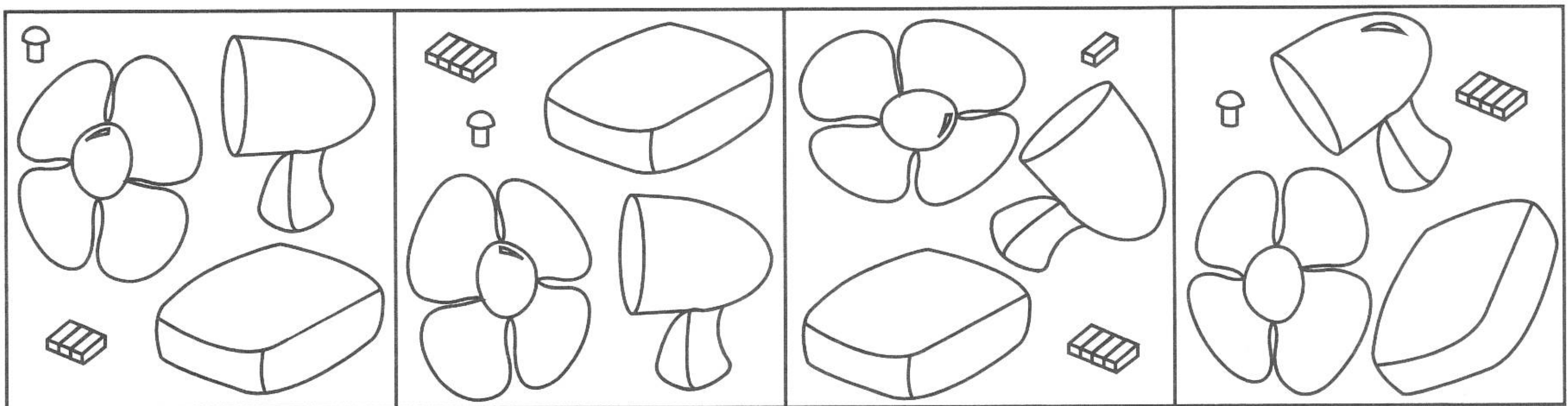
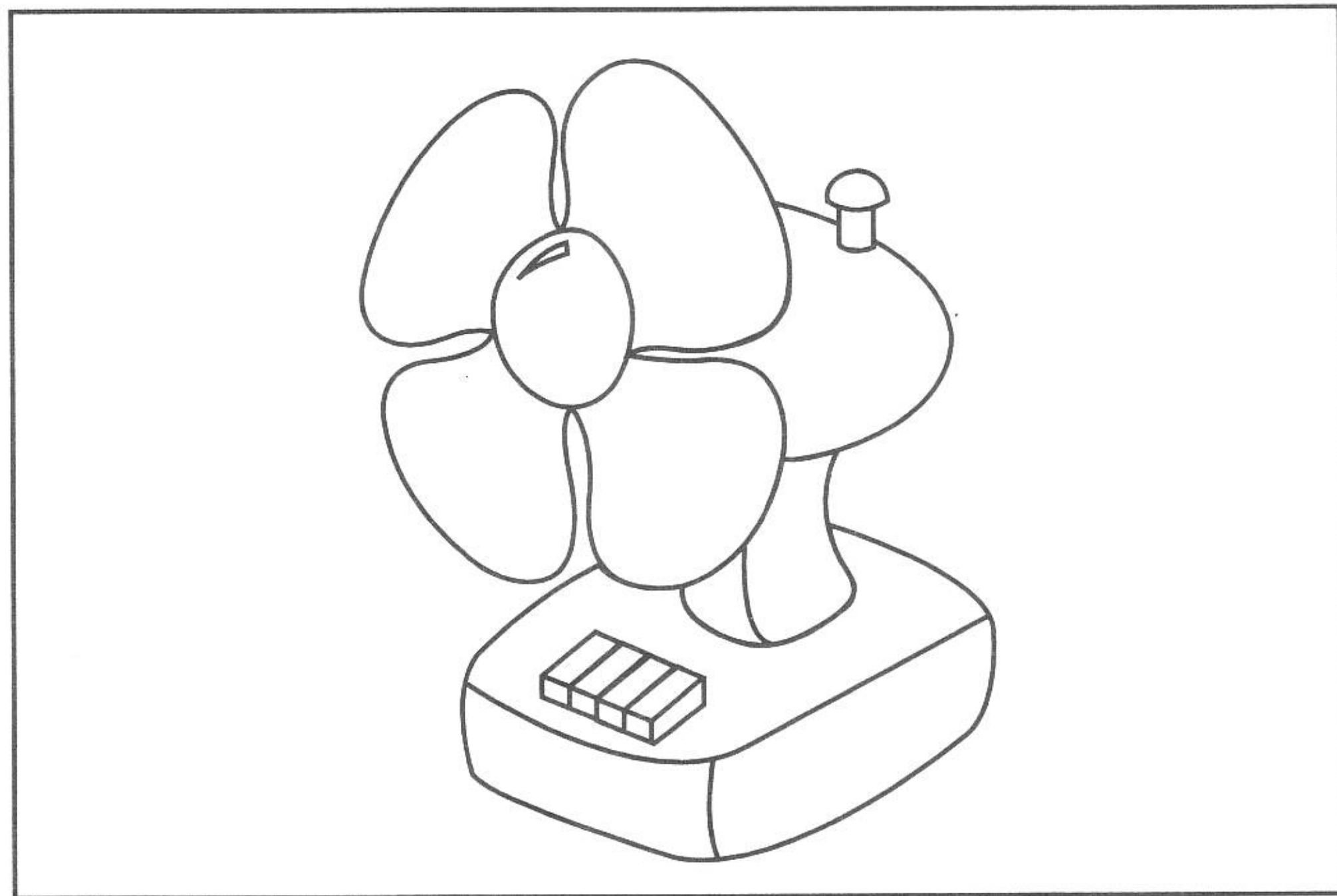

ก

ข

ค

ง

13

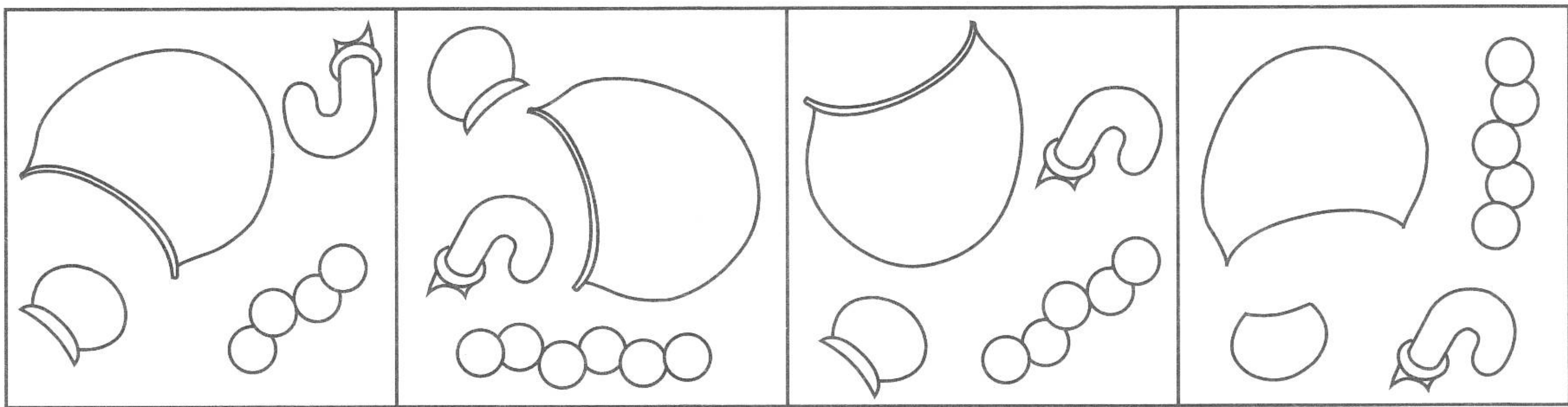
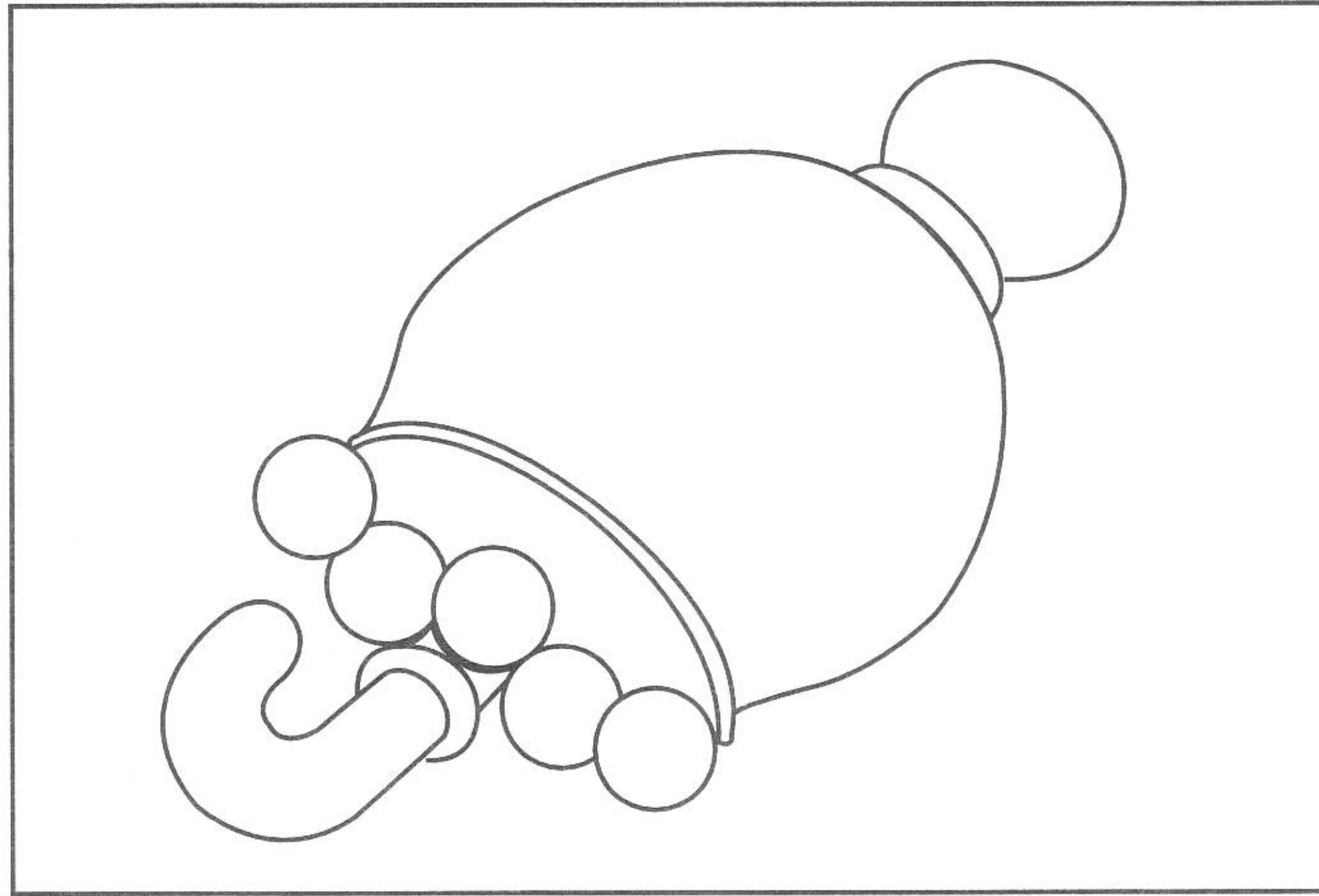

ก

ข

ค

ง

14

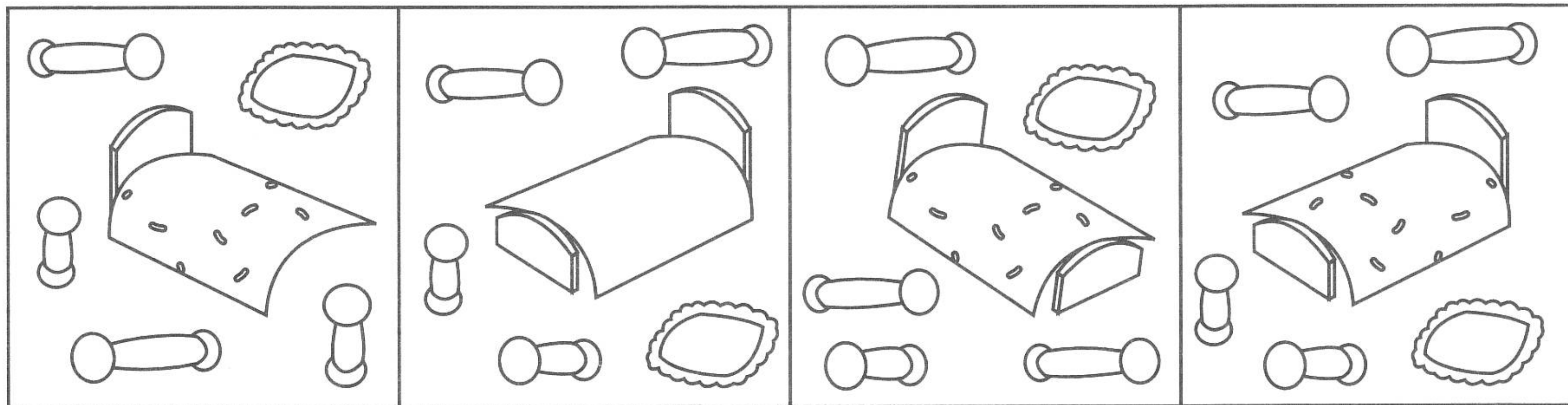
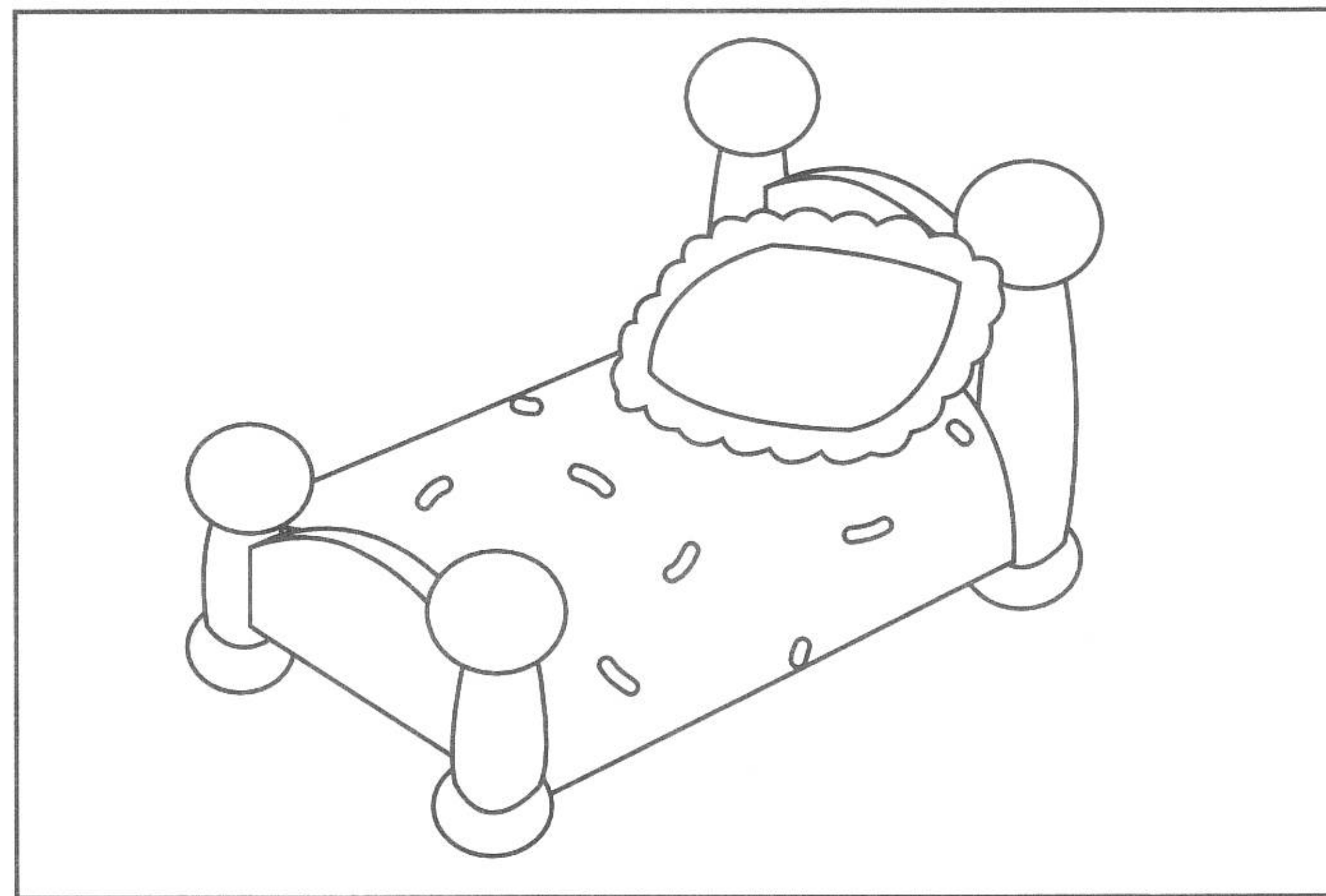

ก

ข

ค

ง

15

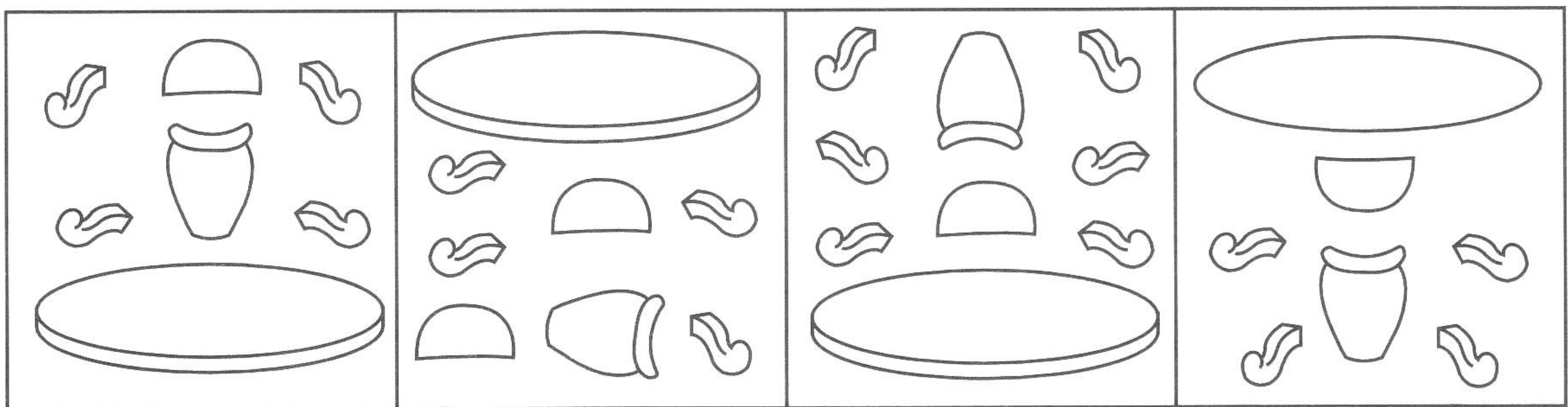
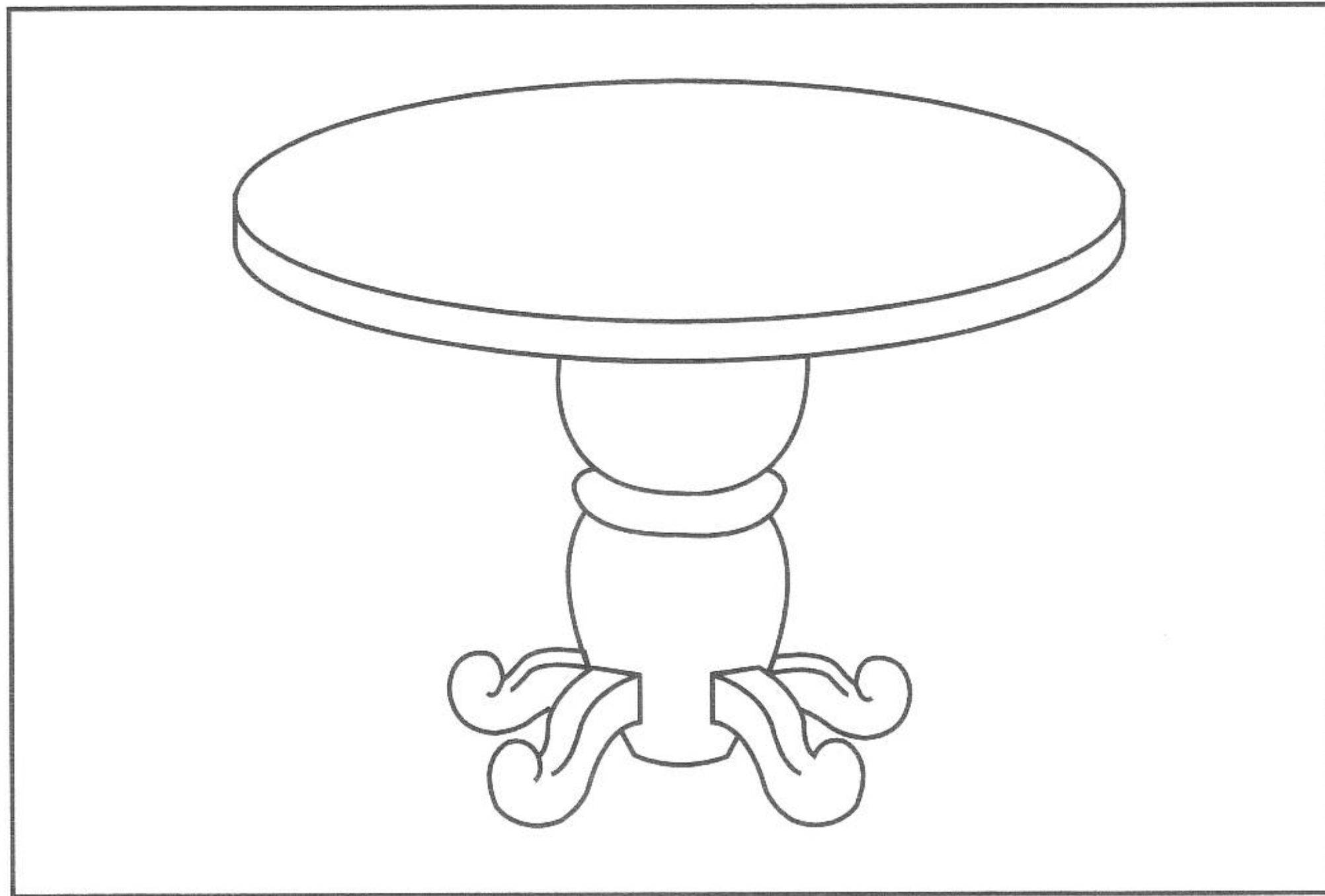

ก

ข

ค

ง

16

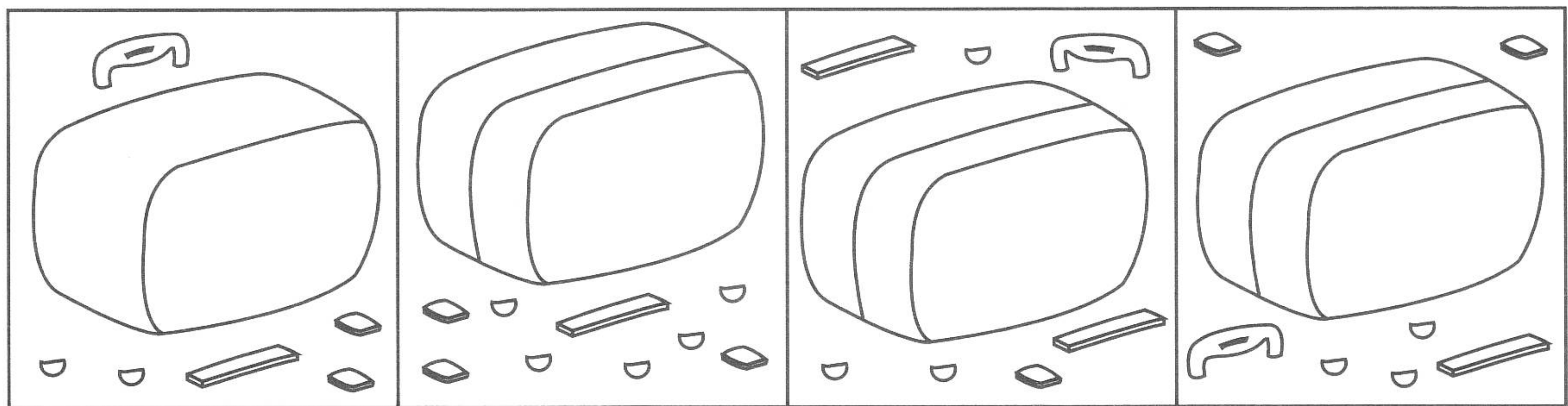
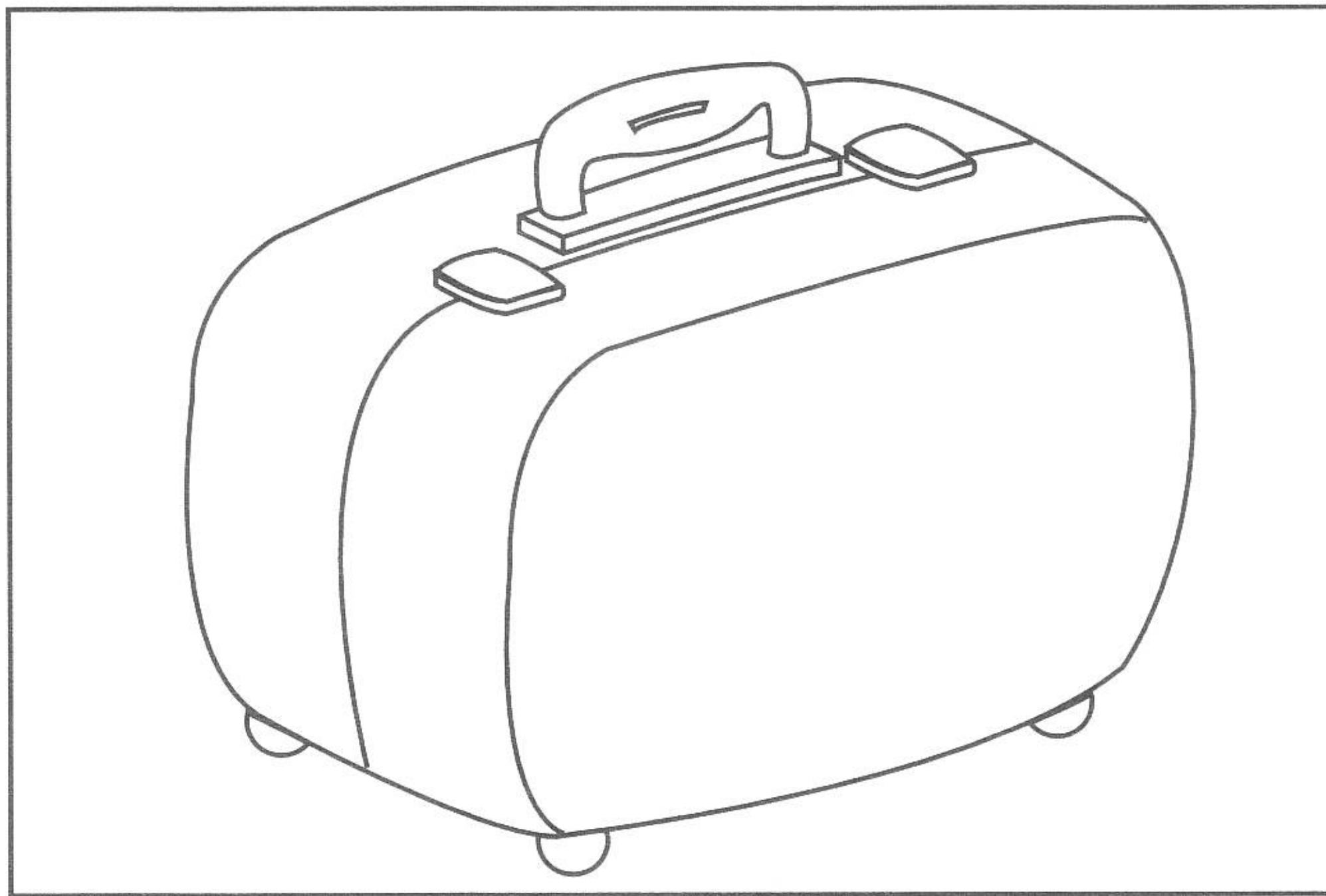

ก

ข

ค

ง

17

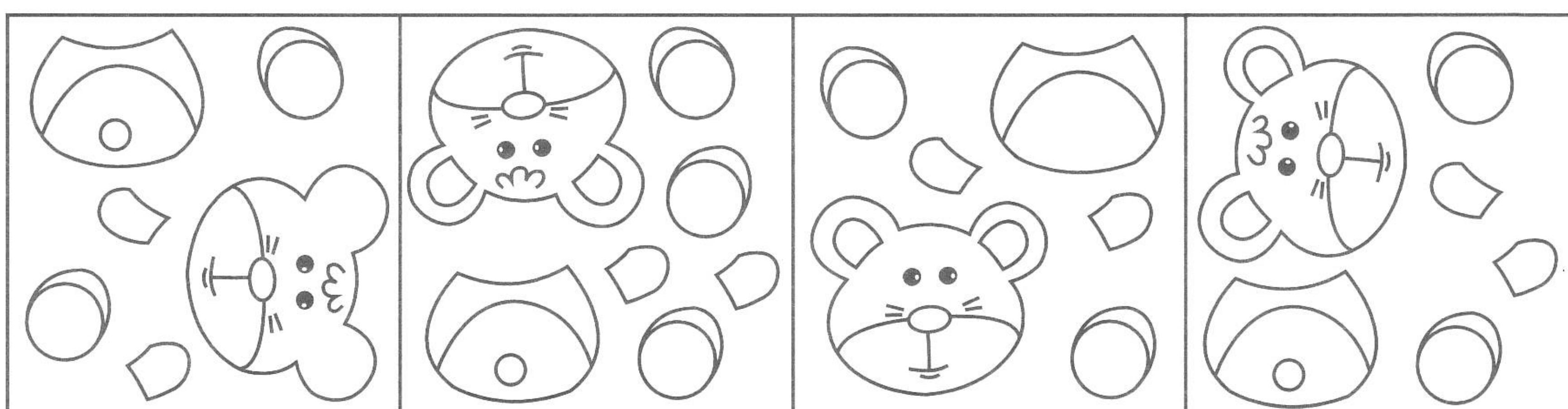
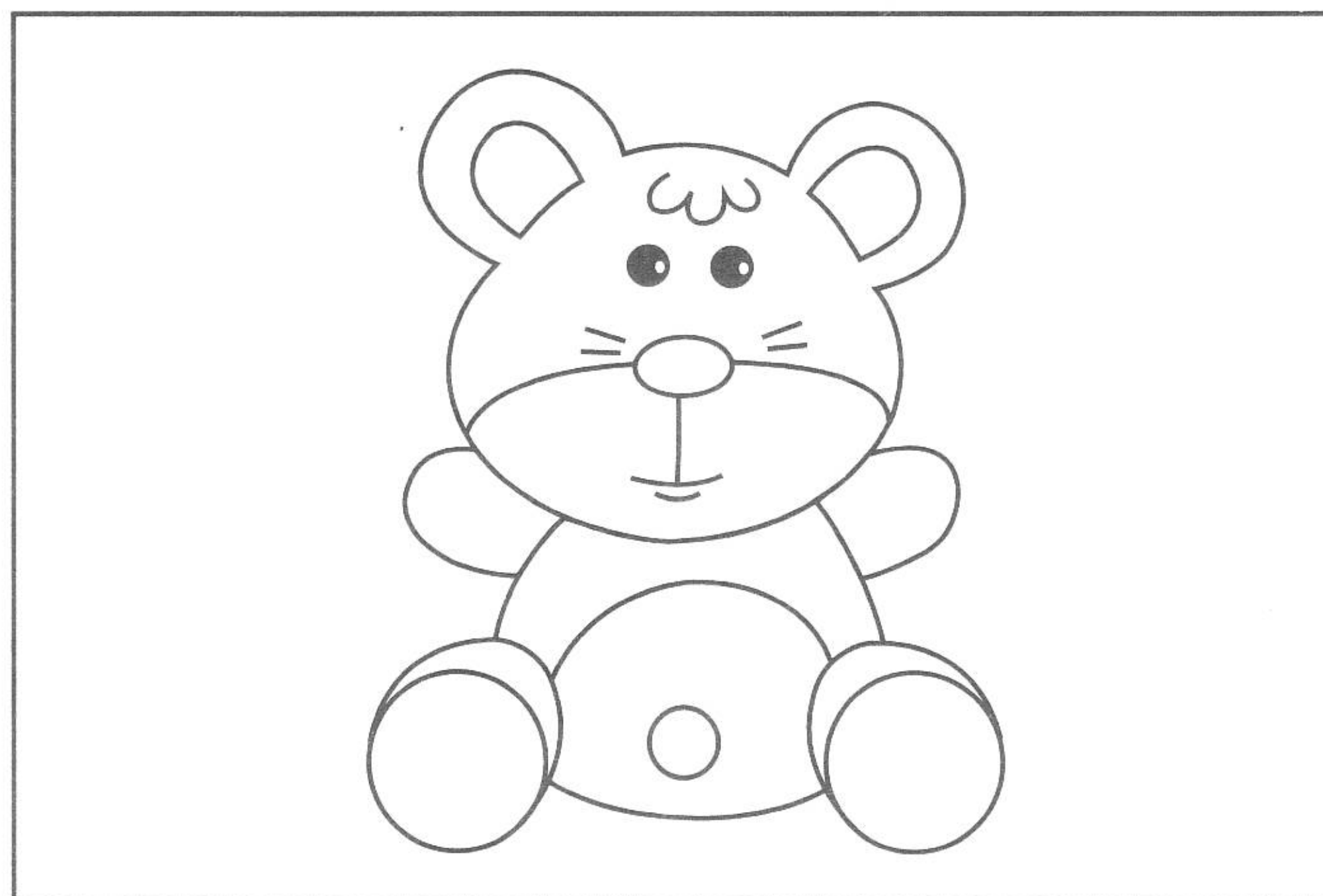

ก

ข

ค

ง

18

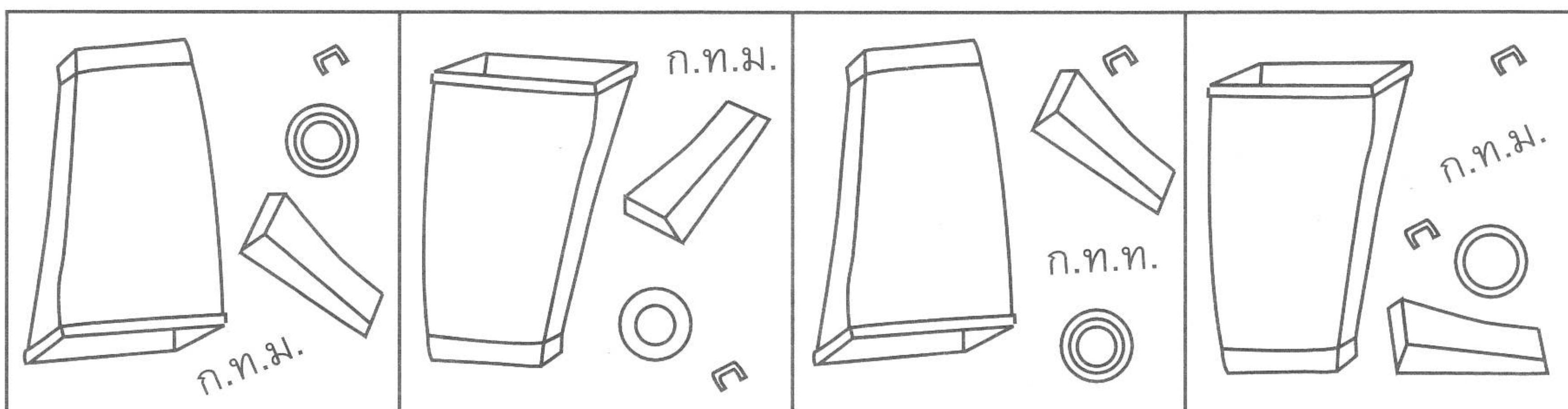

ก

ข

ค

ง

19

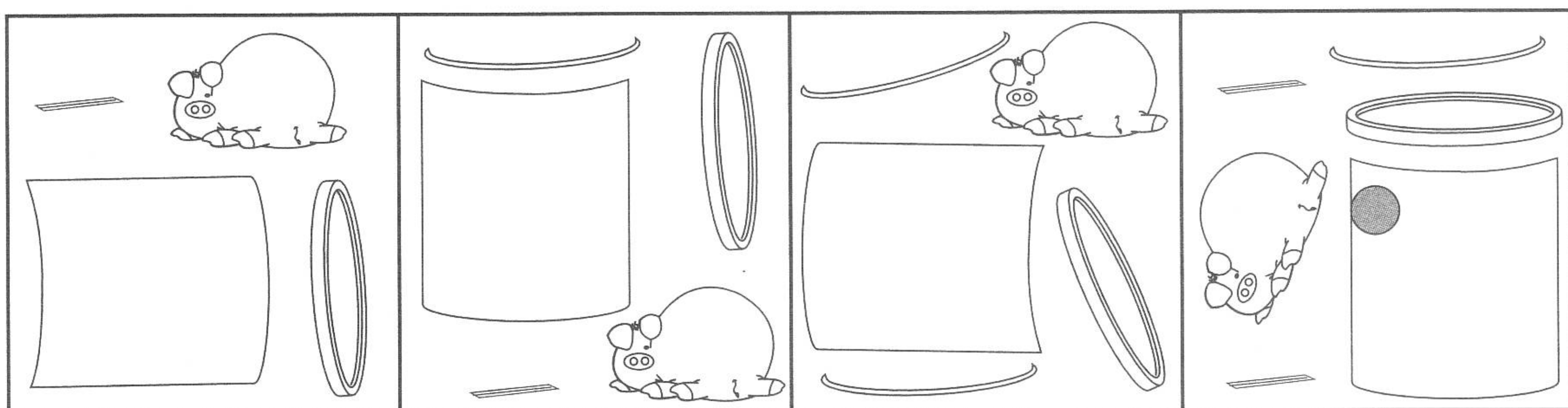

ก

ข

ค

ง

20

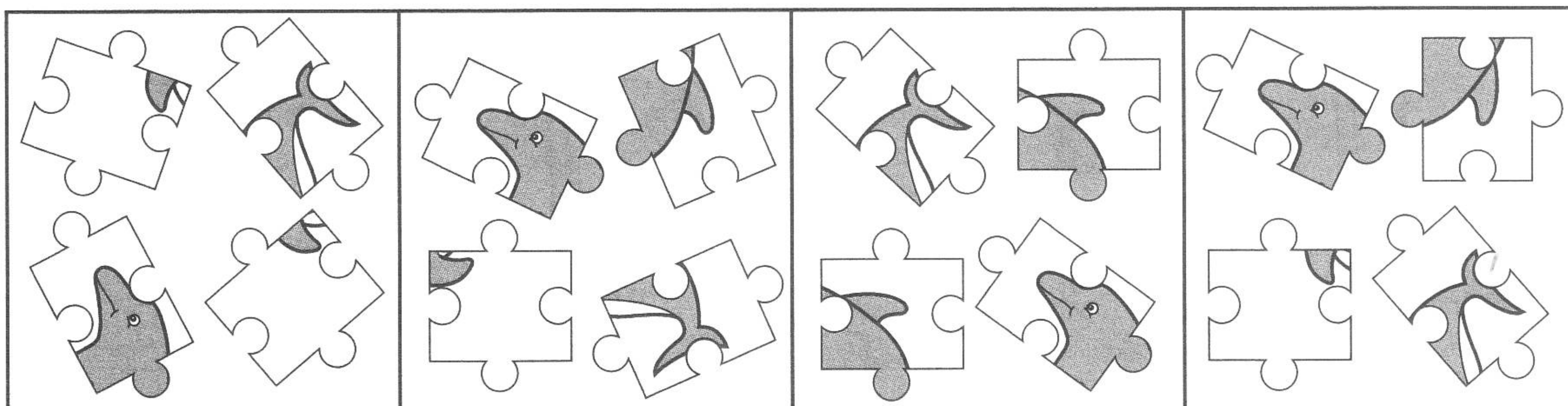
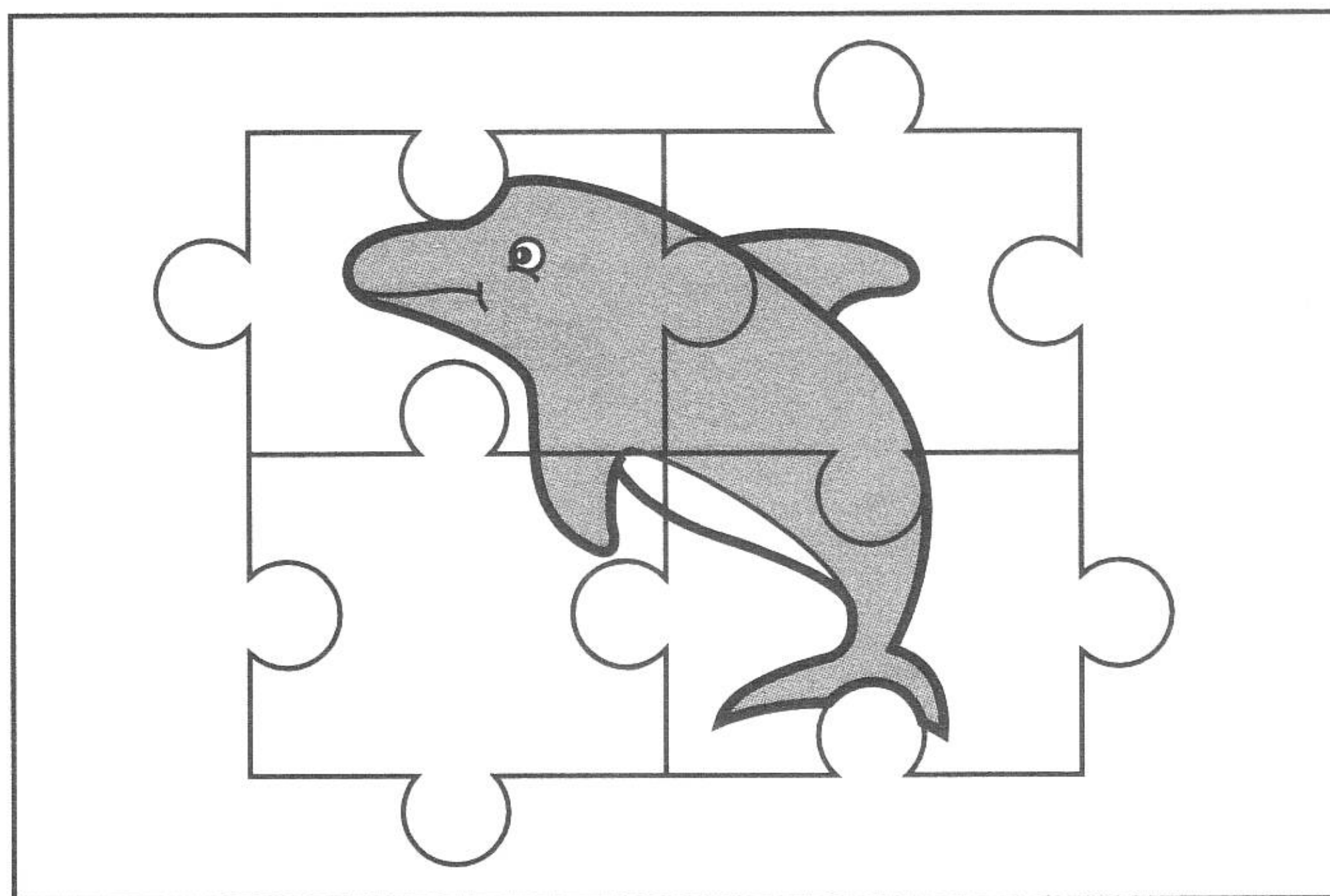

ก

ข

ค

ง

จงต่อลายไม้บล็อกให้ถูกต้องโดยเลือก ข้อที่ถูกต้อง

1

	 ก	 ข
	 ค	 ง

2

	 ก	 ข
	 ค	 ง

3

	 ก	 ข
	 ค	 ง

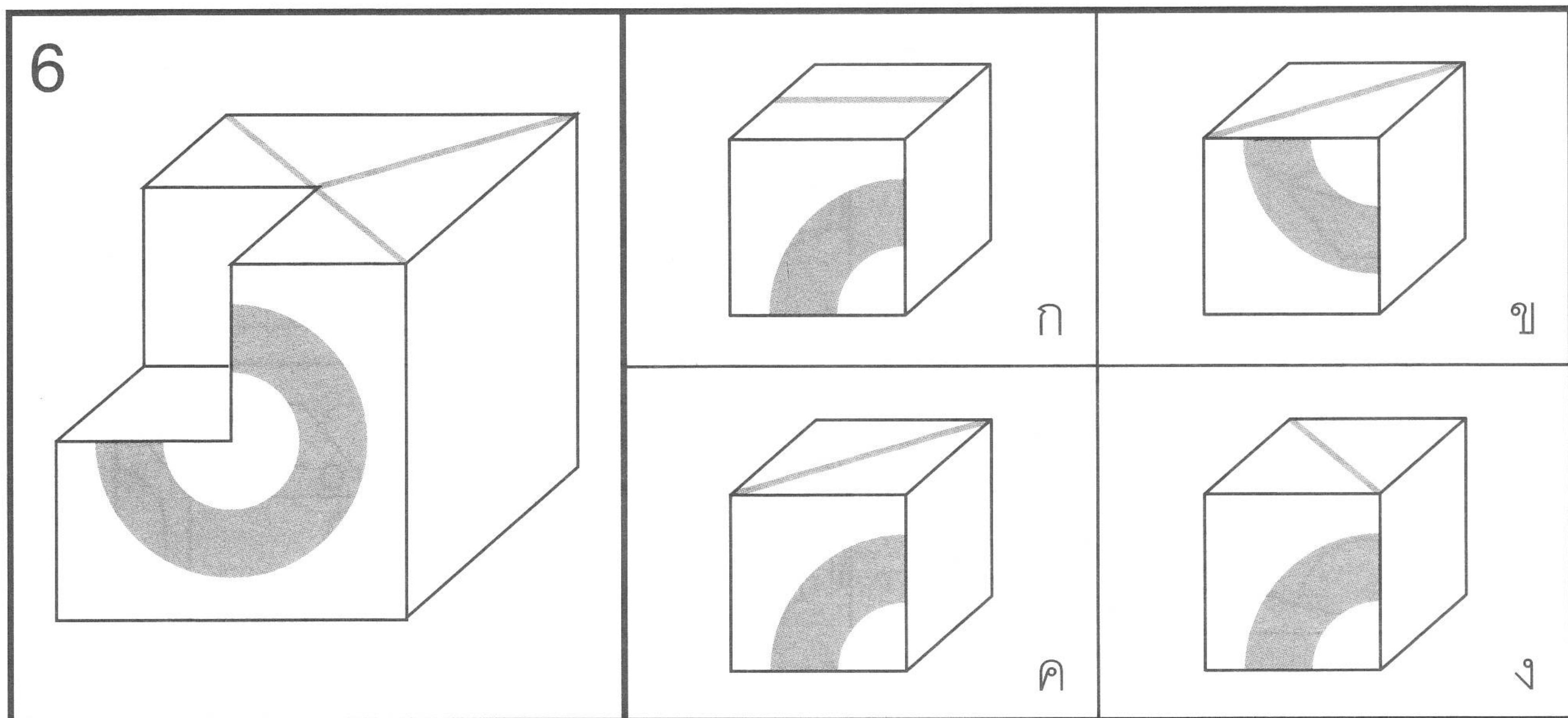
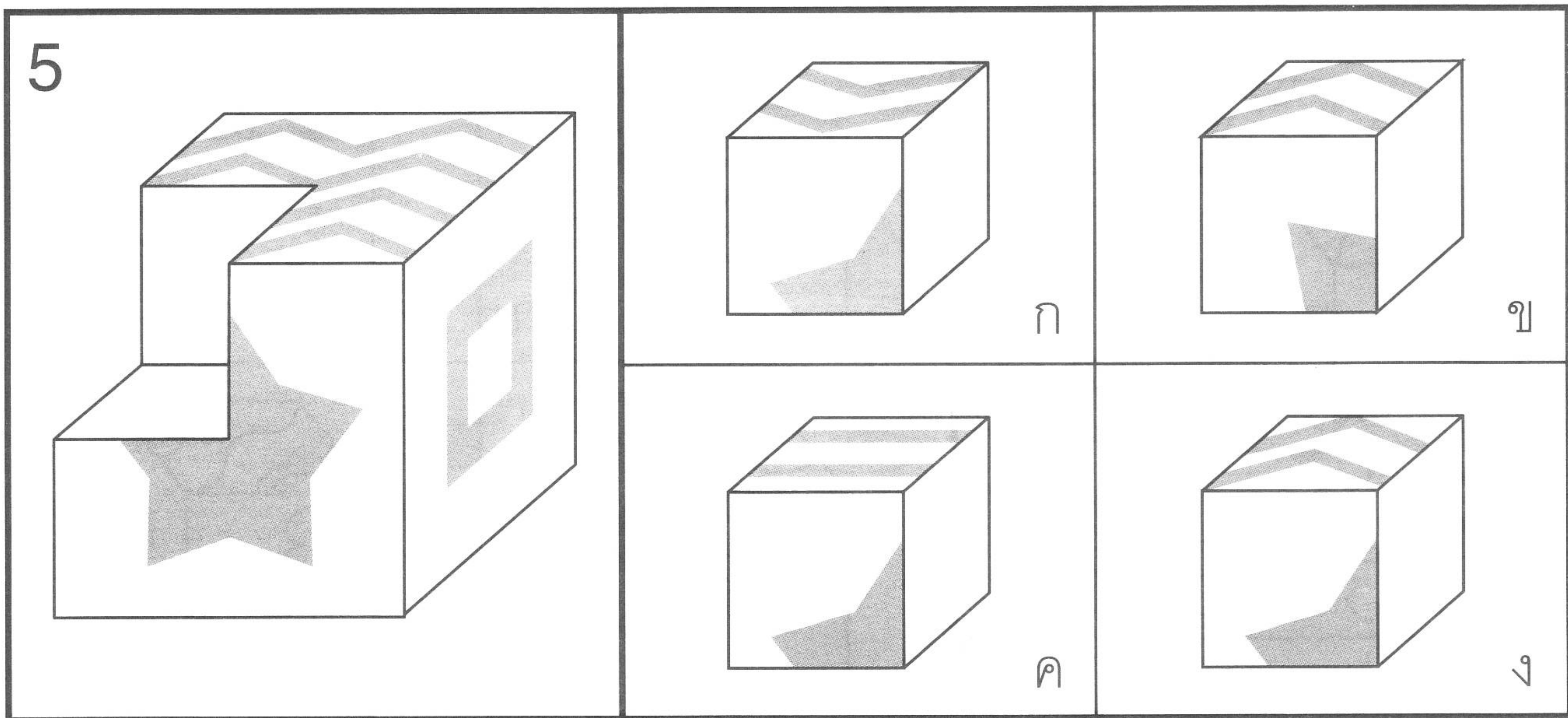
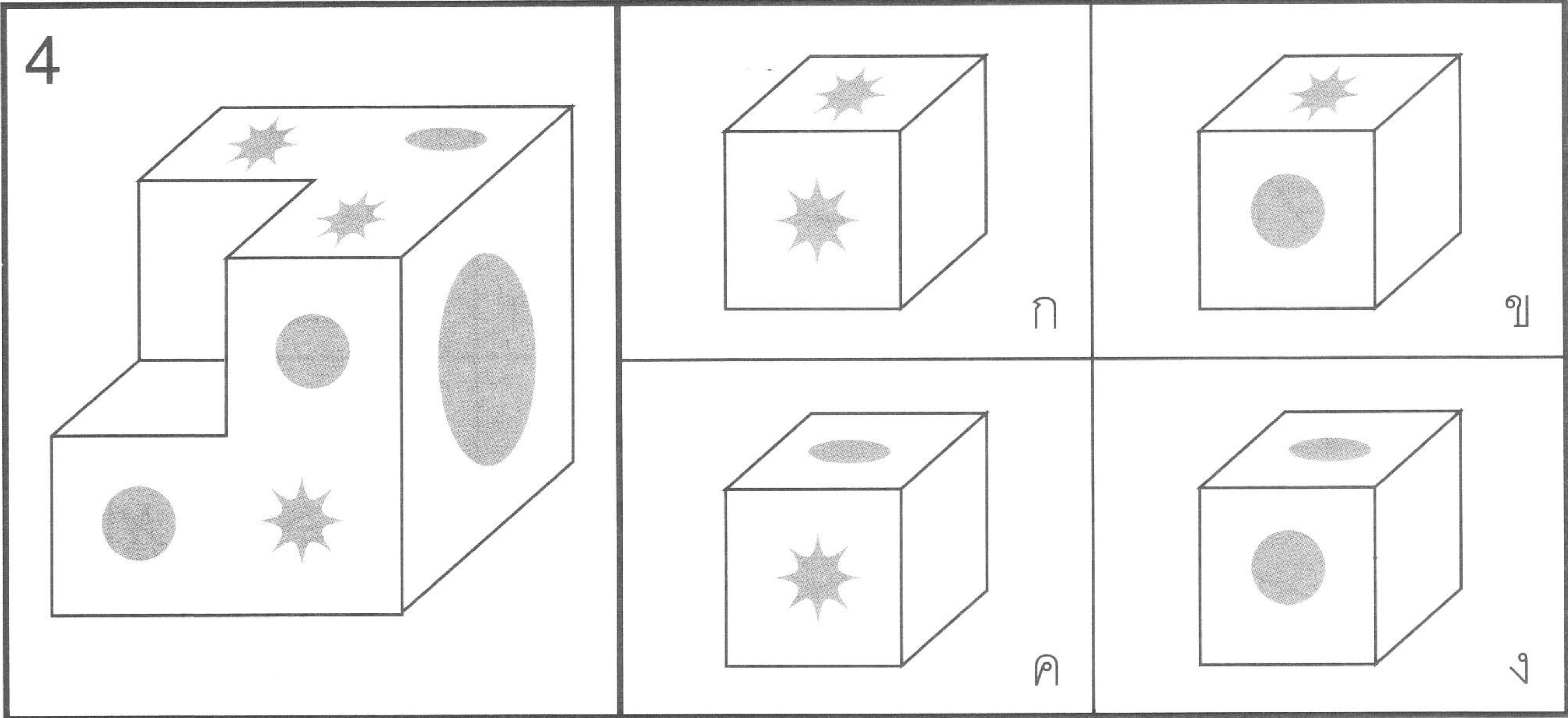

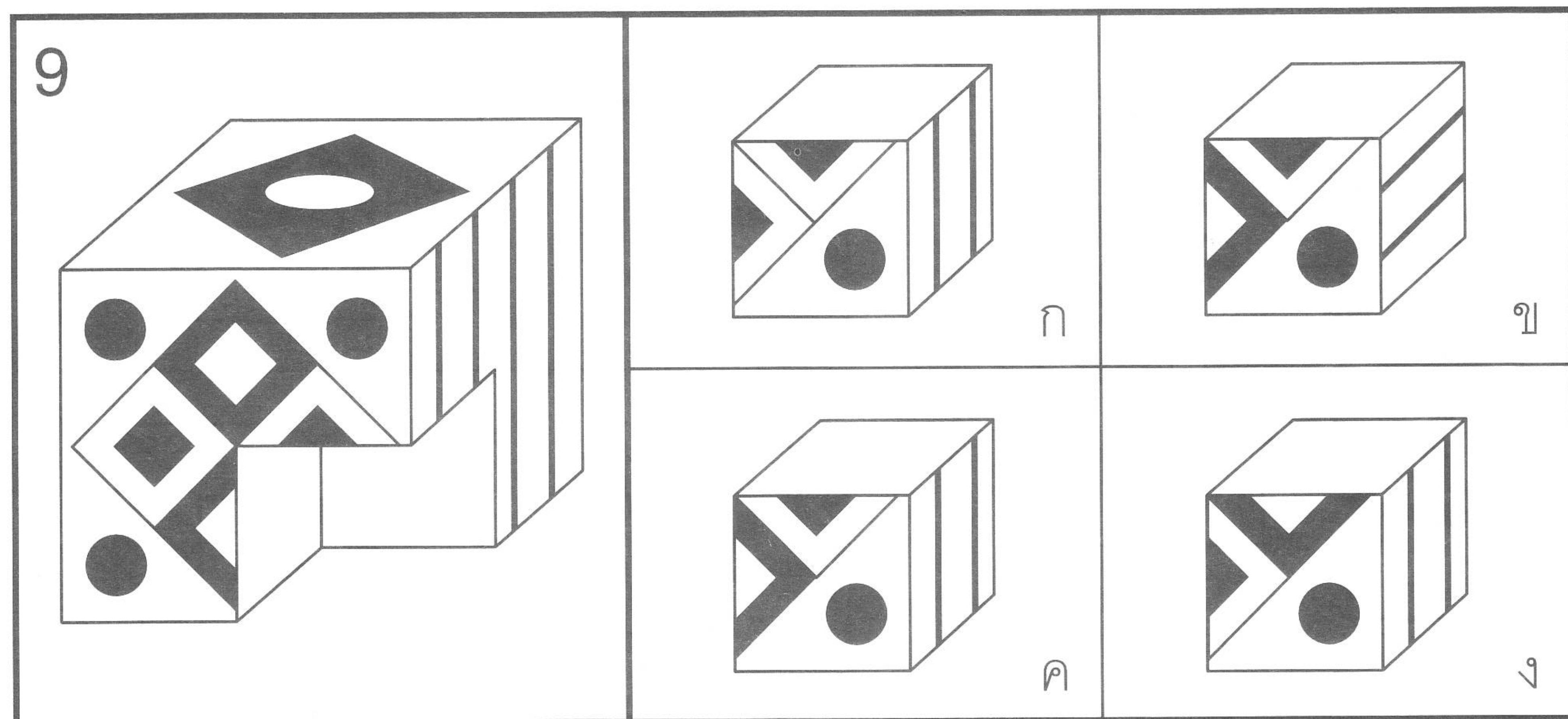
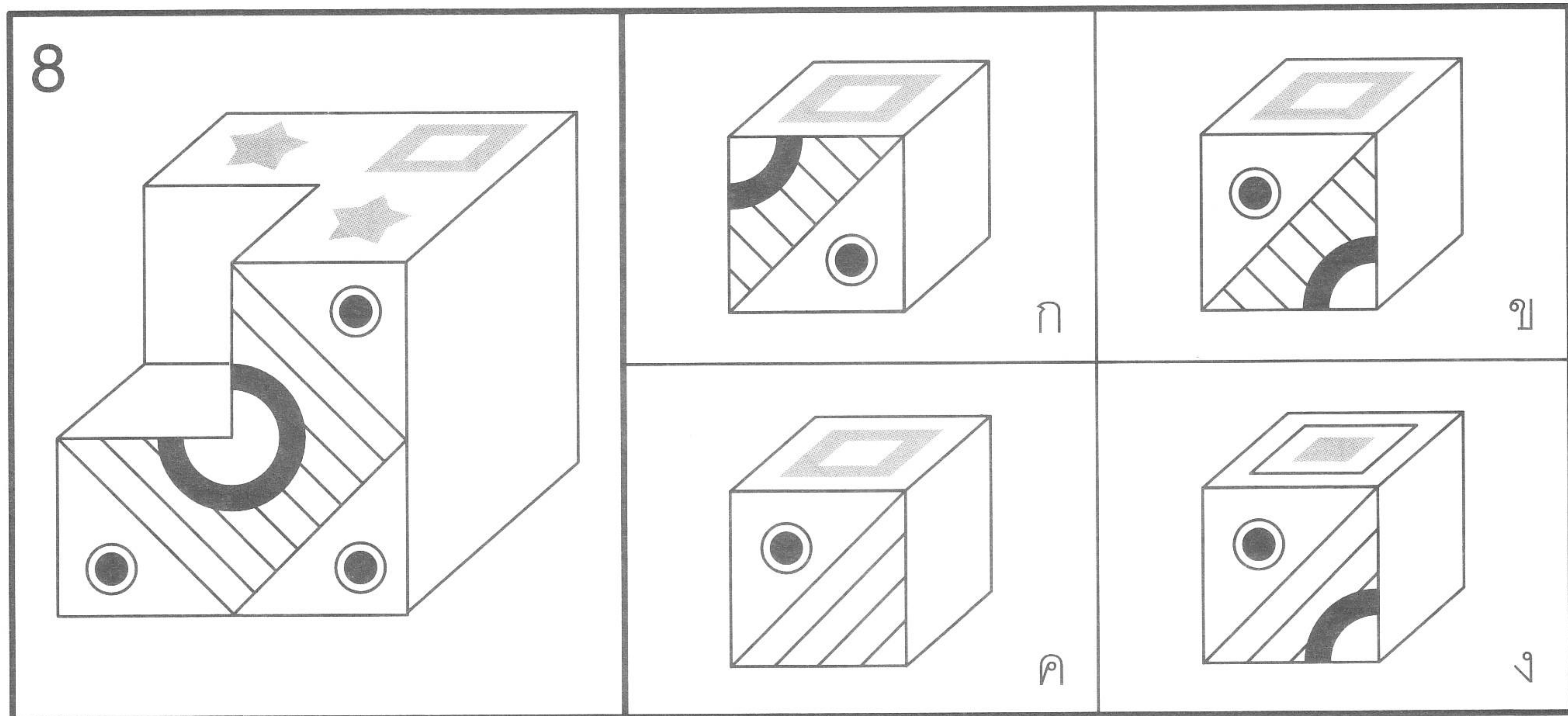
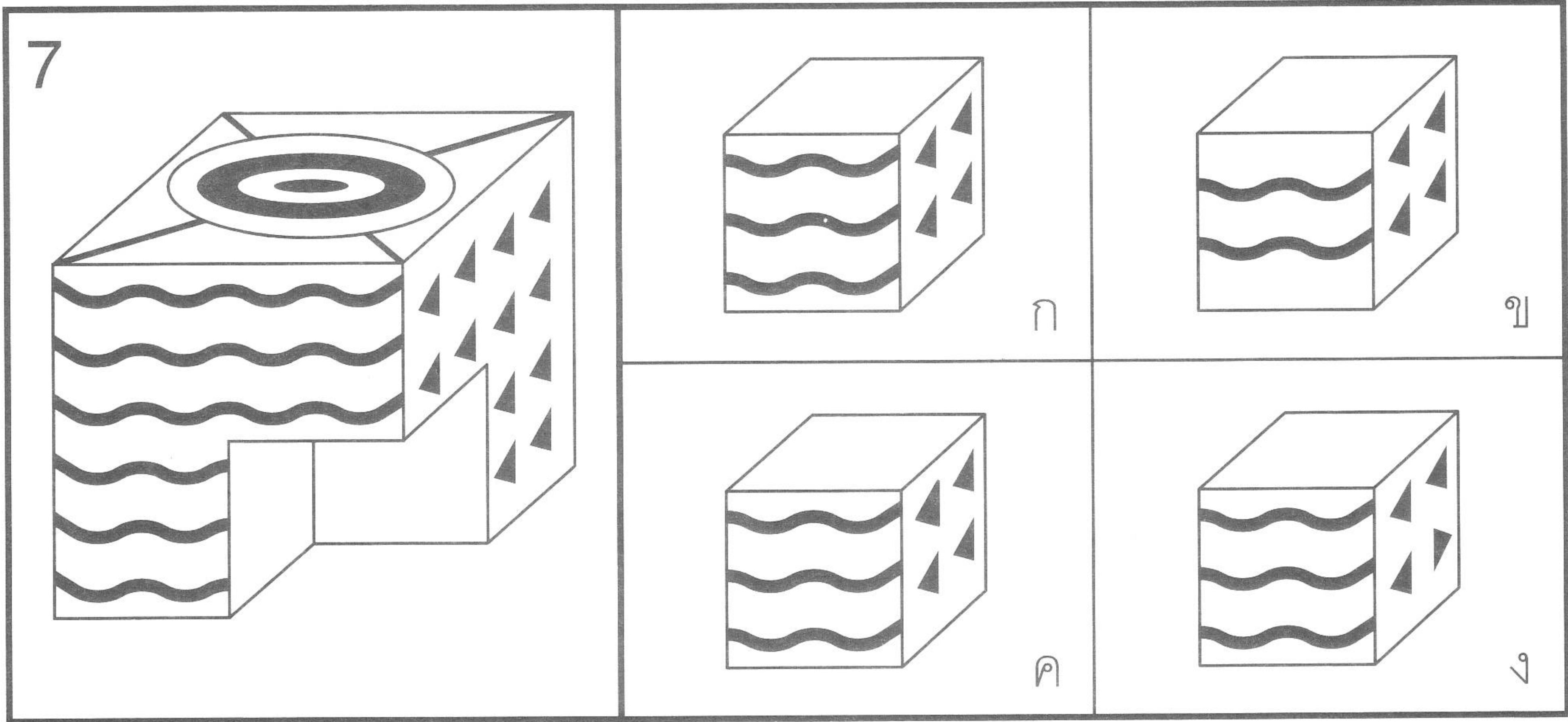

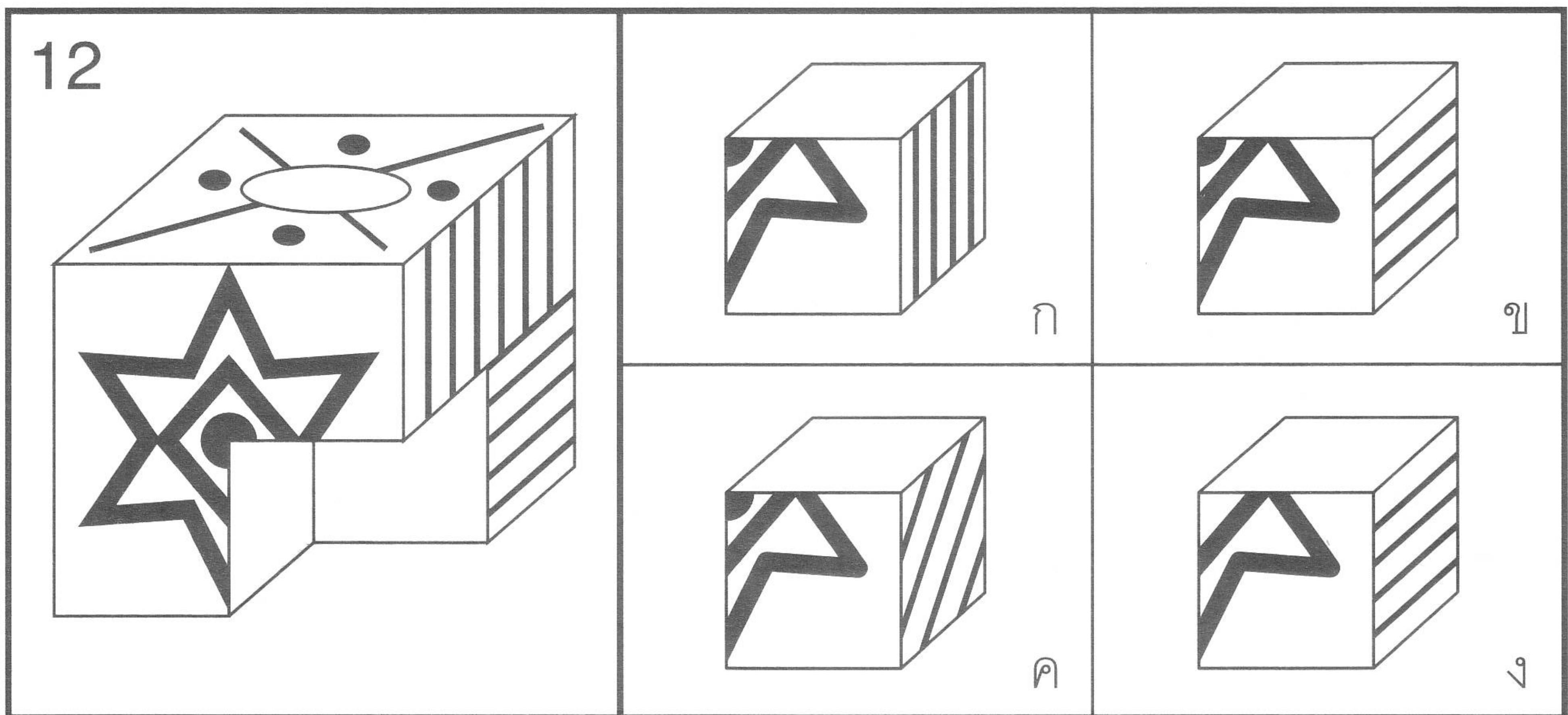
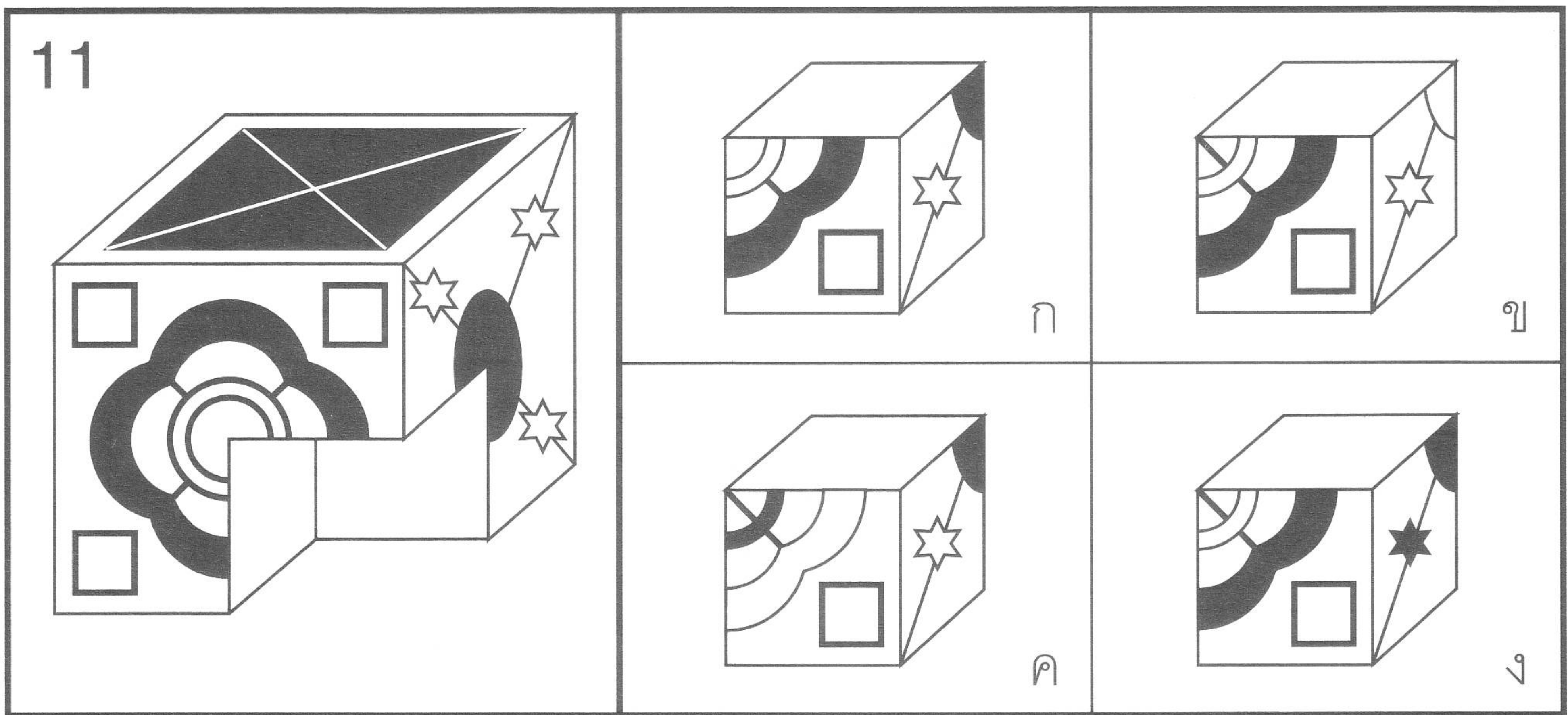
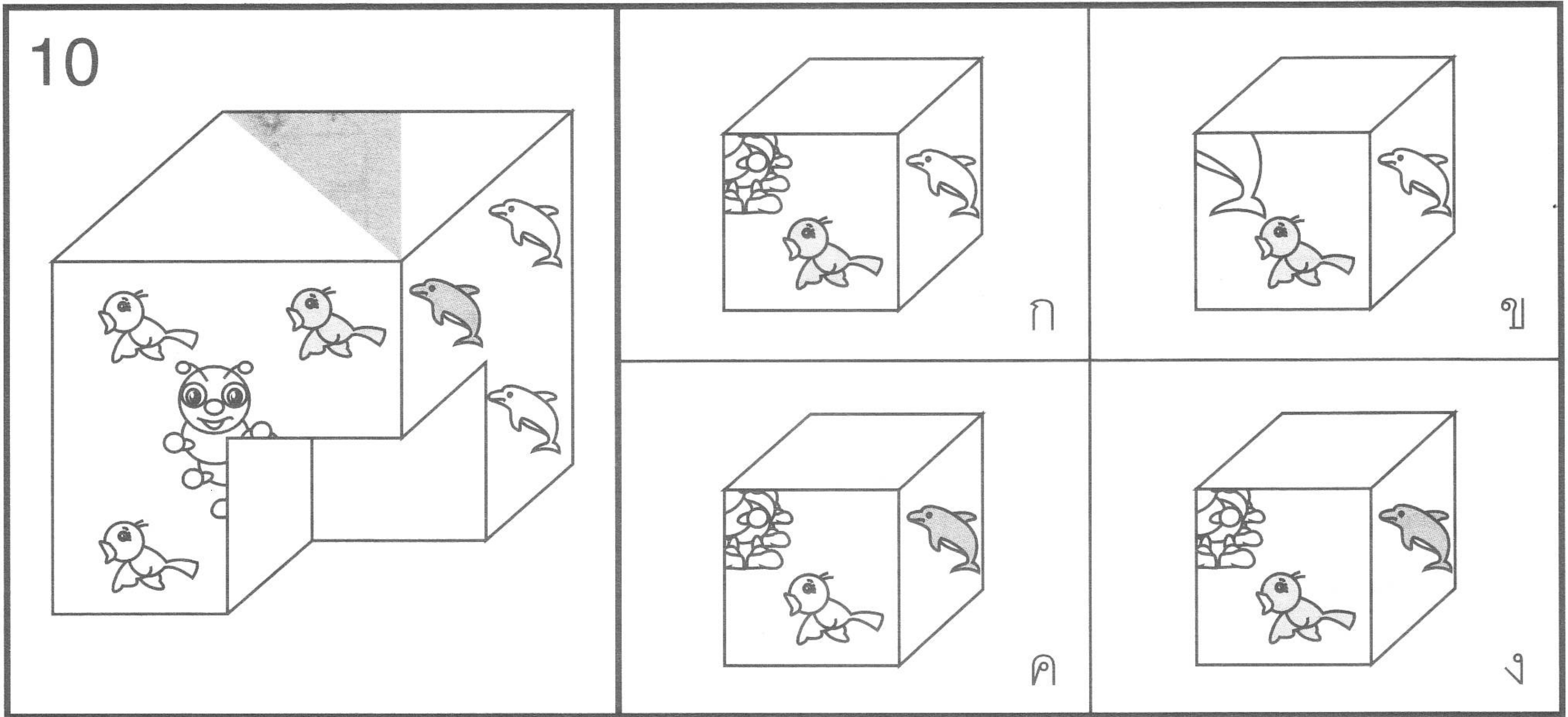

13

ก ข
ค ง

14

ก ข
ค ง

15

ก ข
ค ง

16

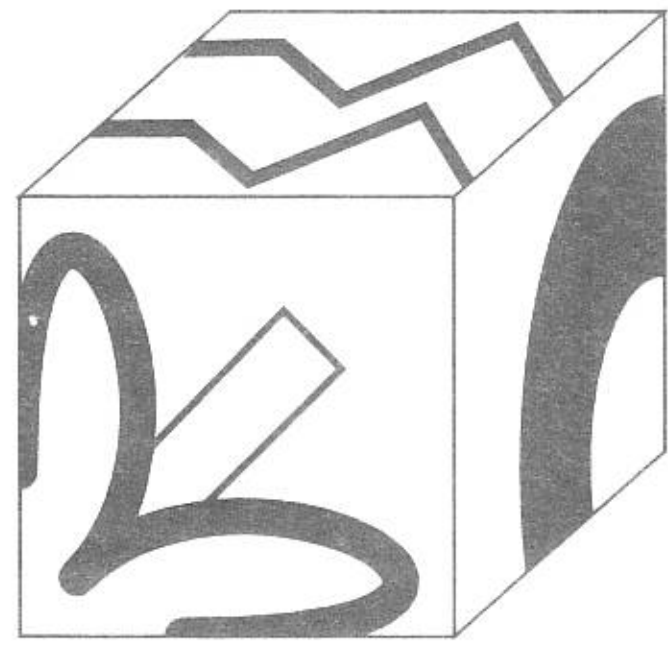
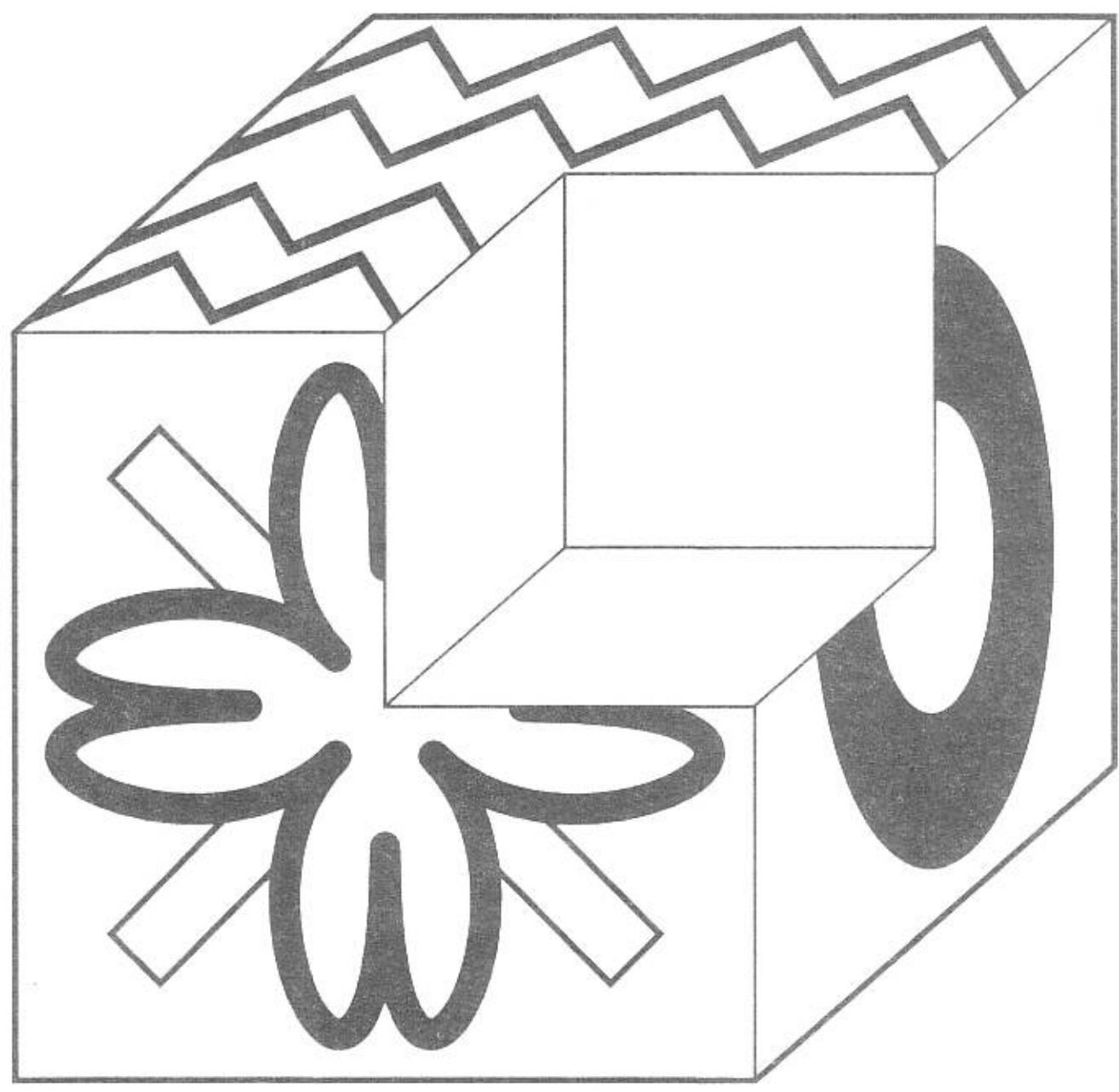

ก

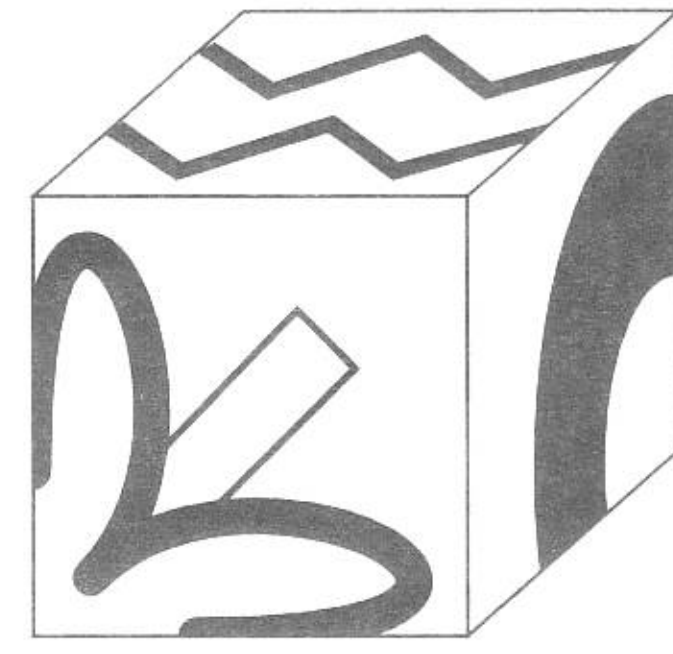

ข

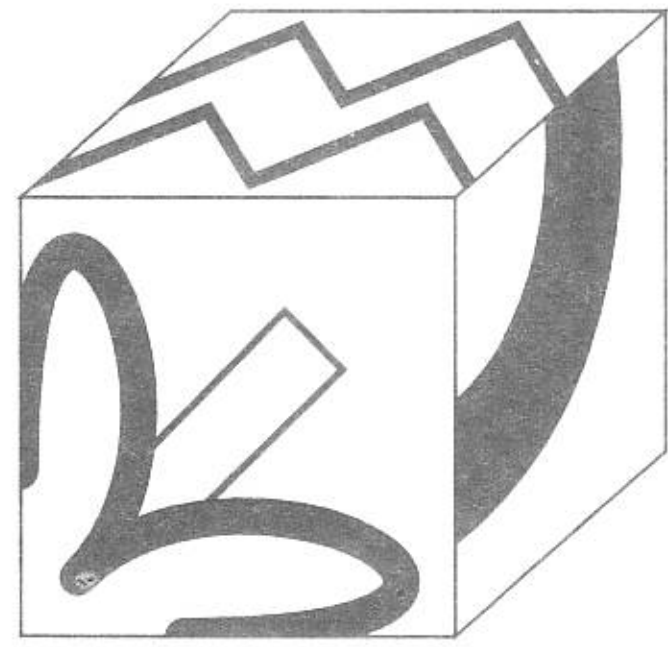

ค

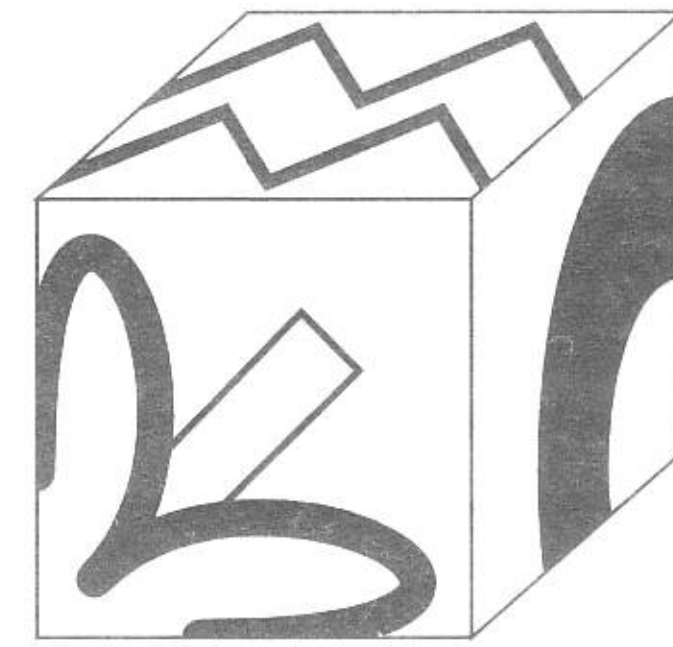

ง

17

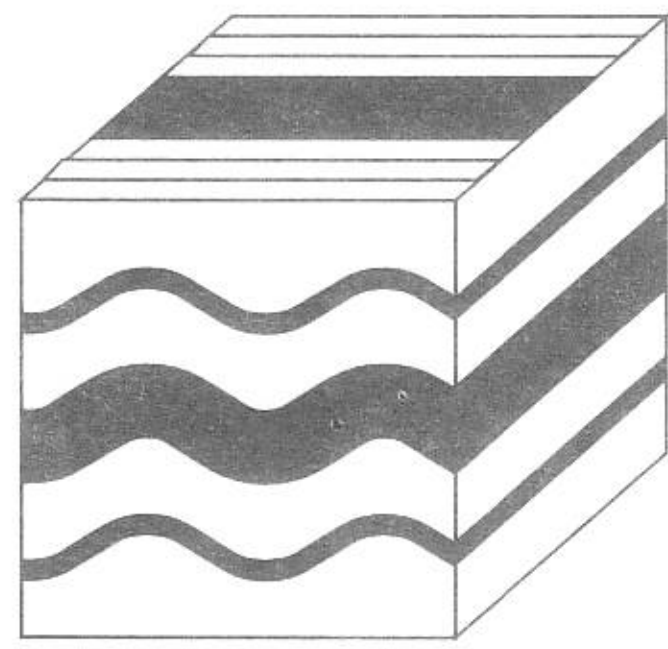
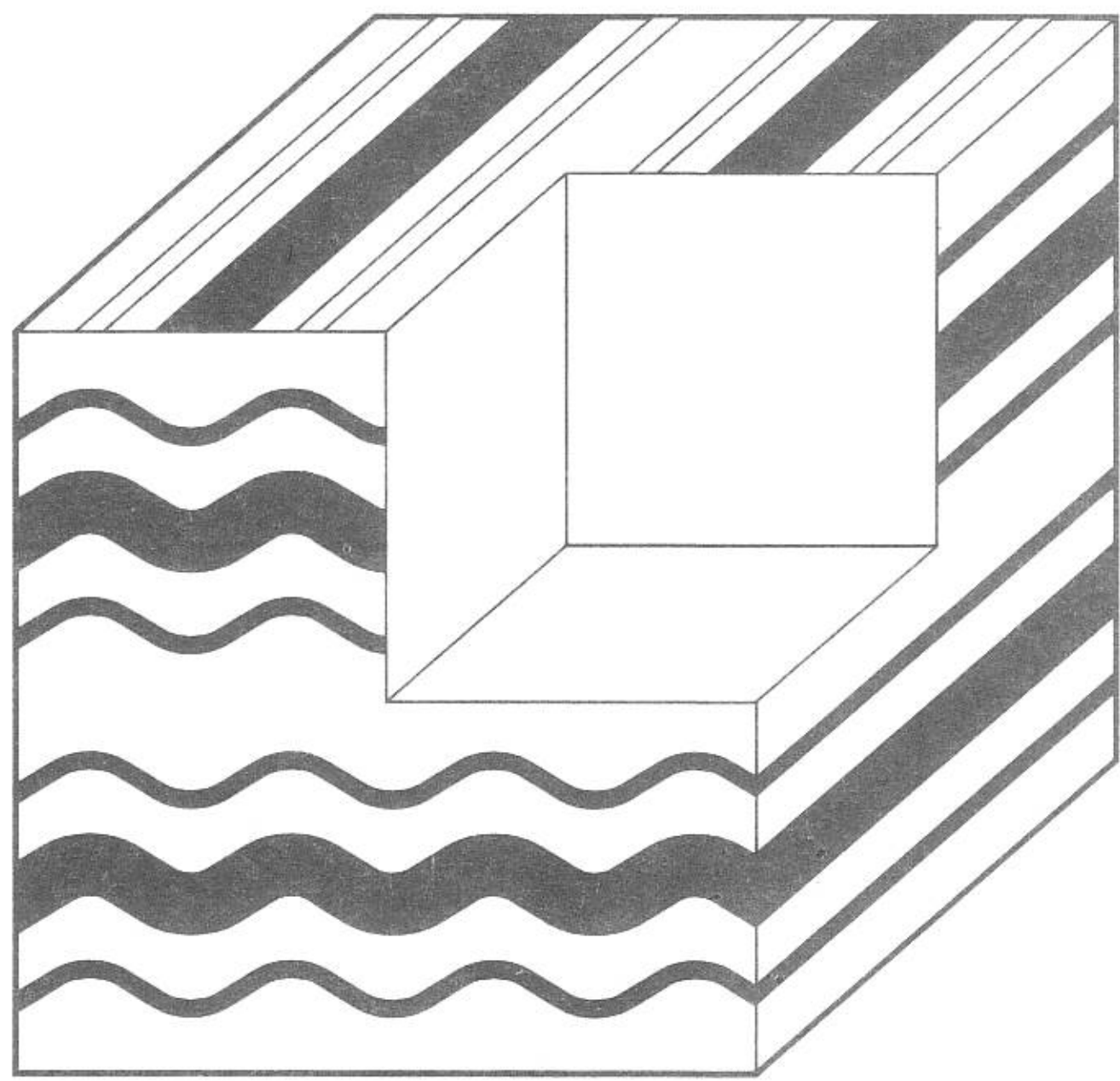

ก

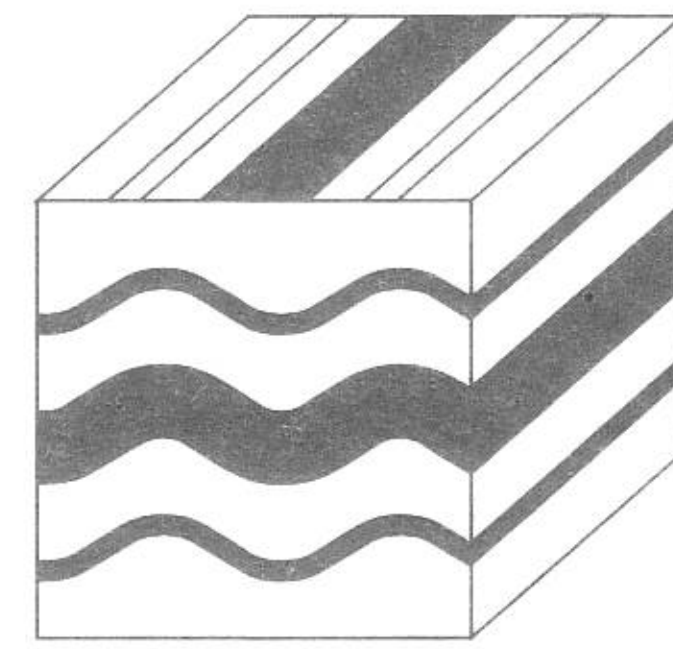

ข

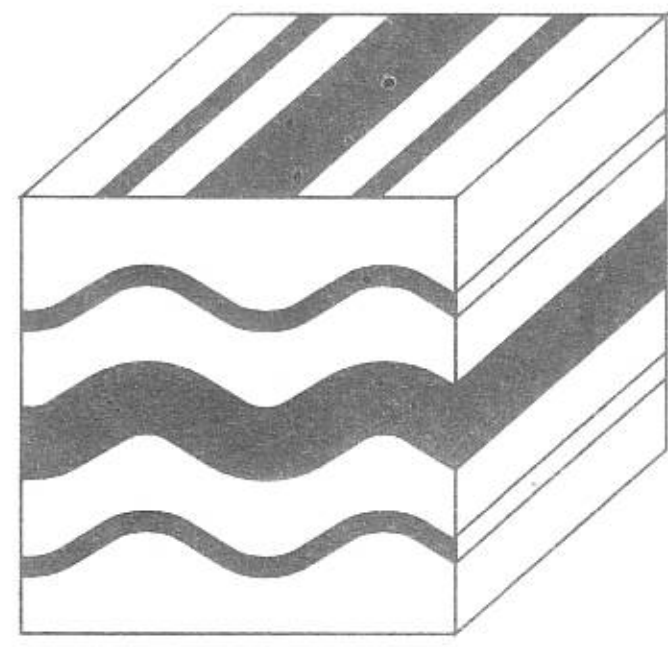

ค

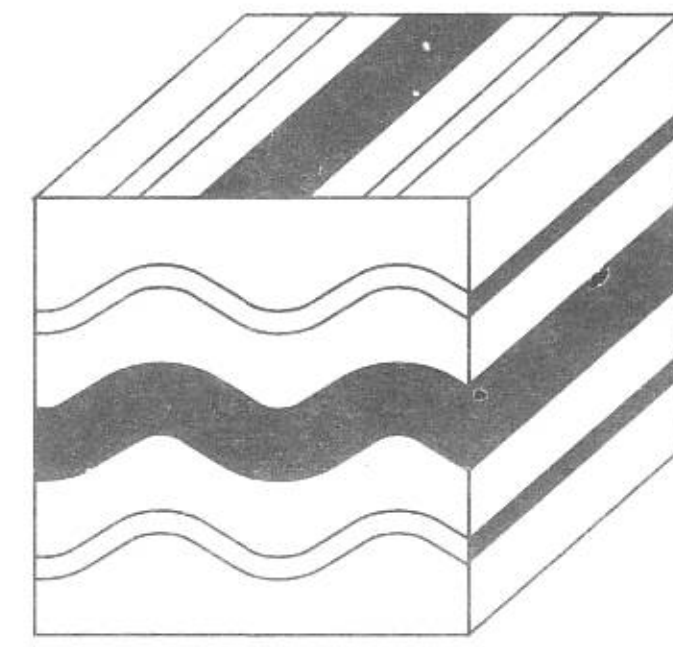

ง

18

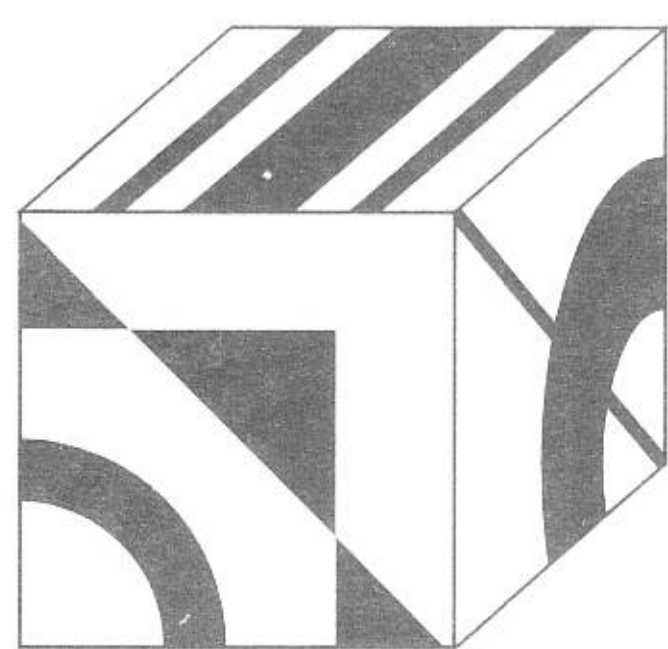
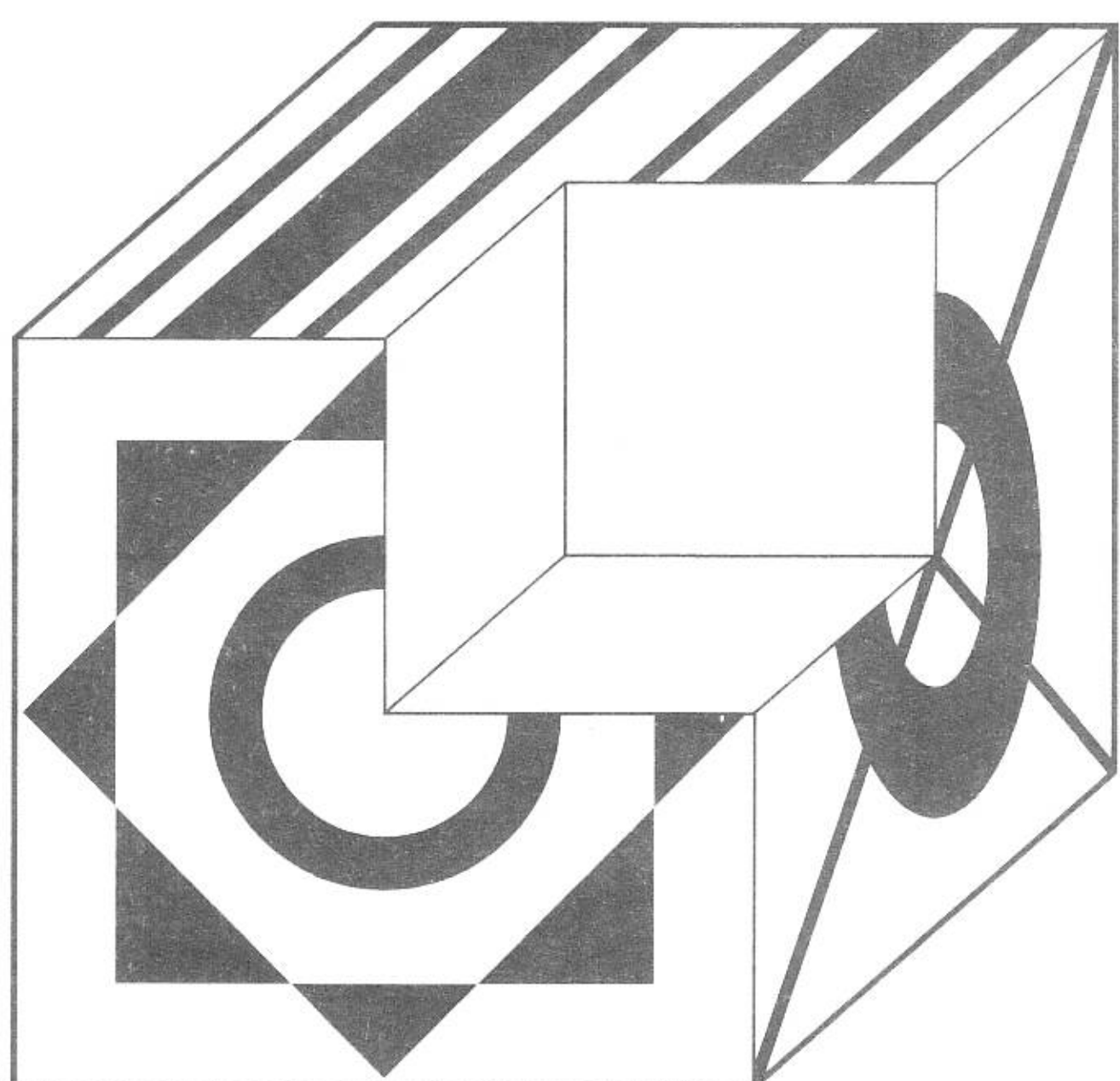

ก

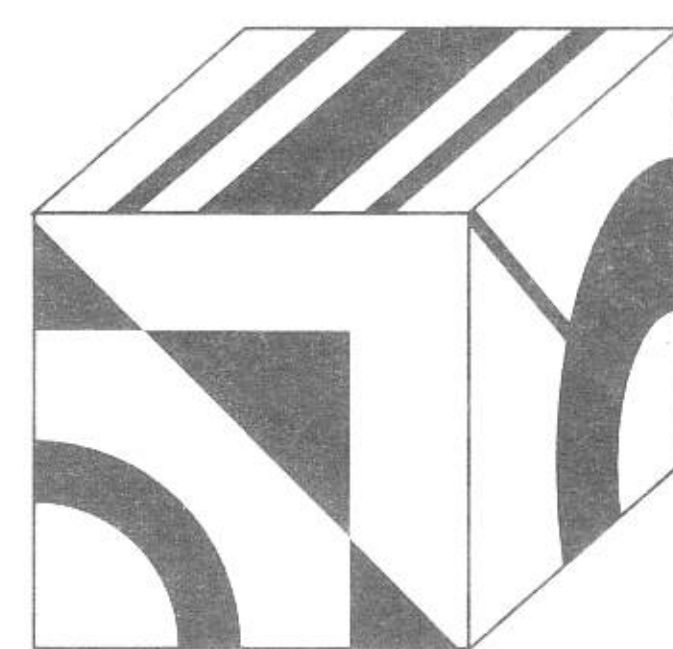

ข

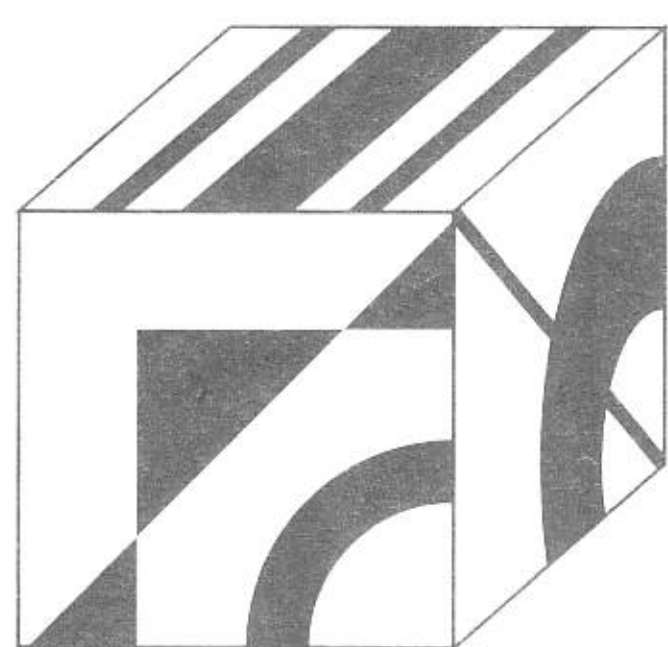

ค

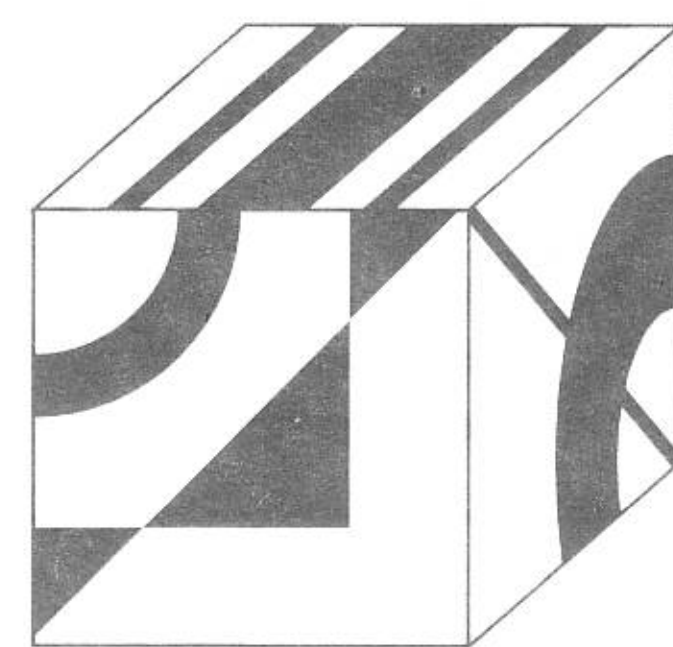

ง

19

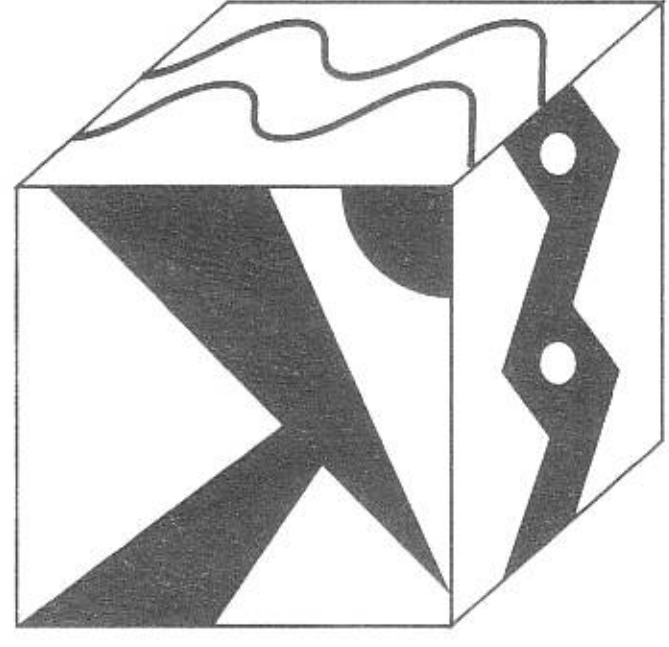
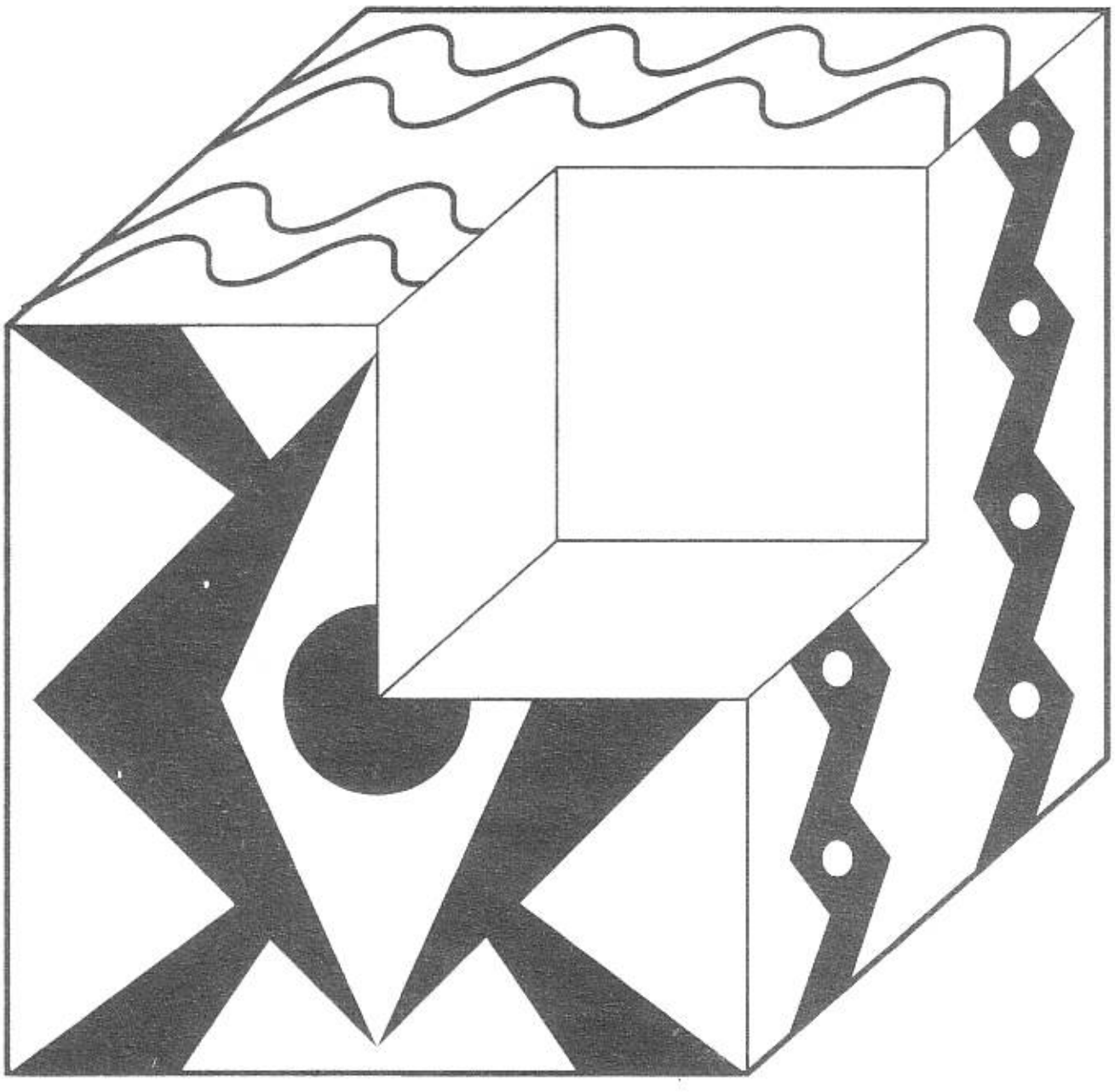

ก

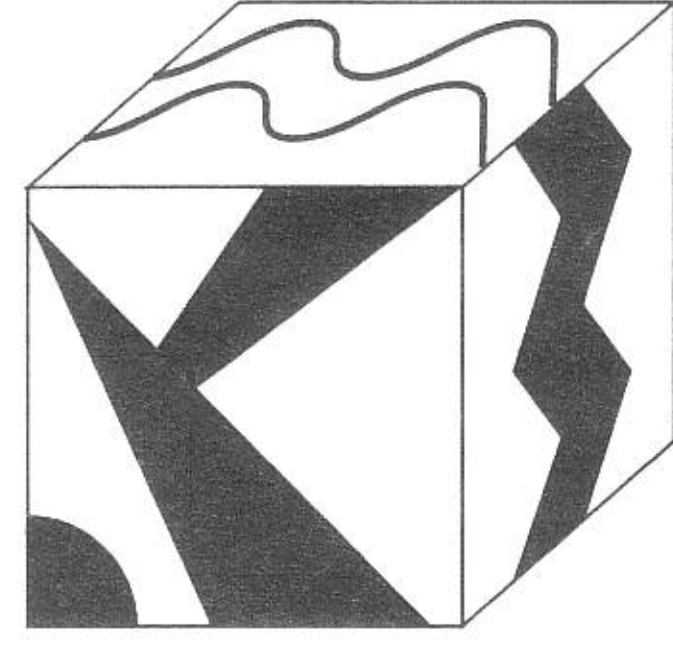

ข

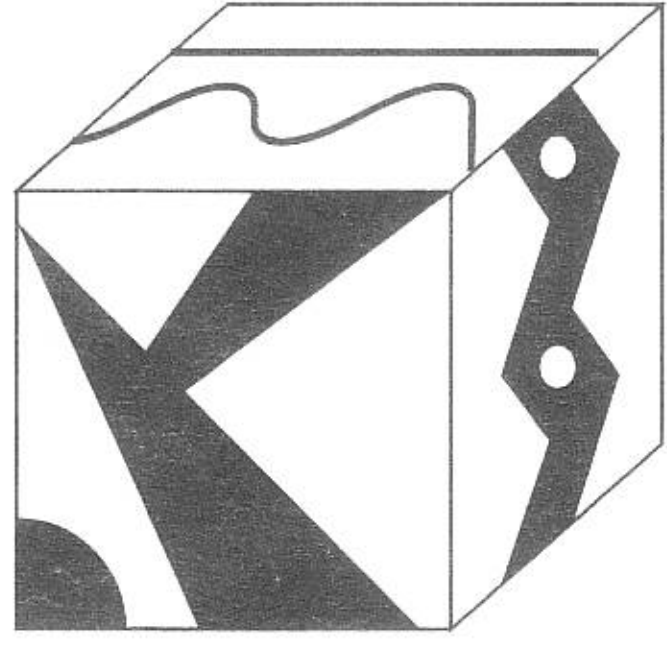

ค

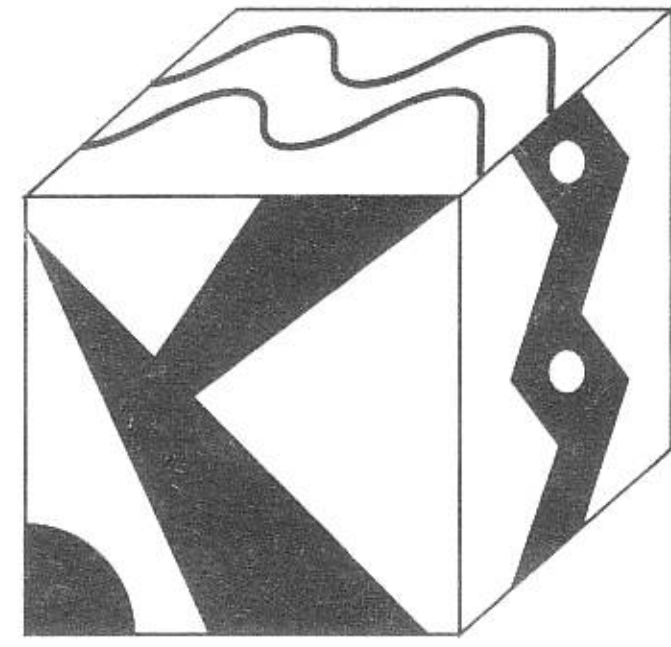

ง

20

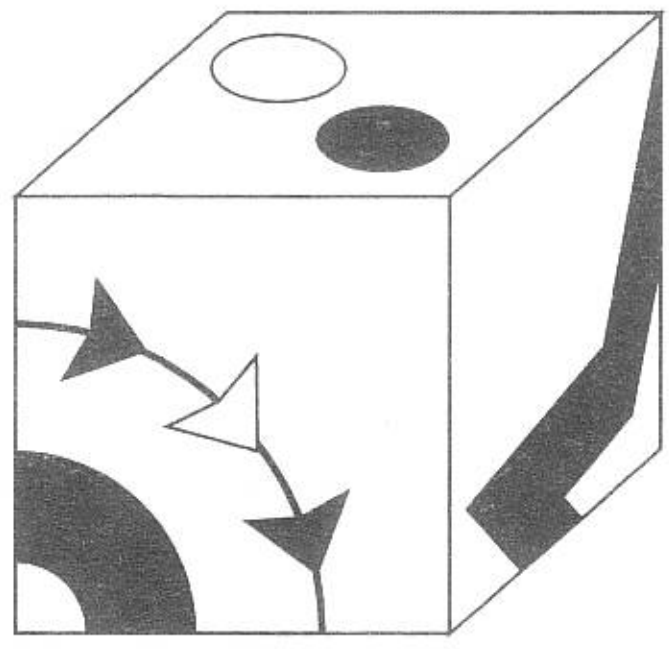
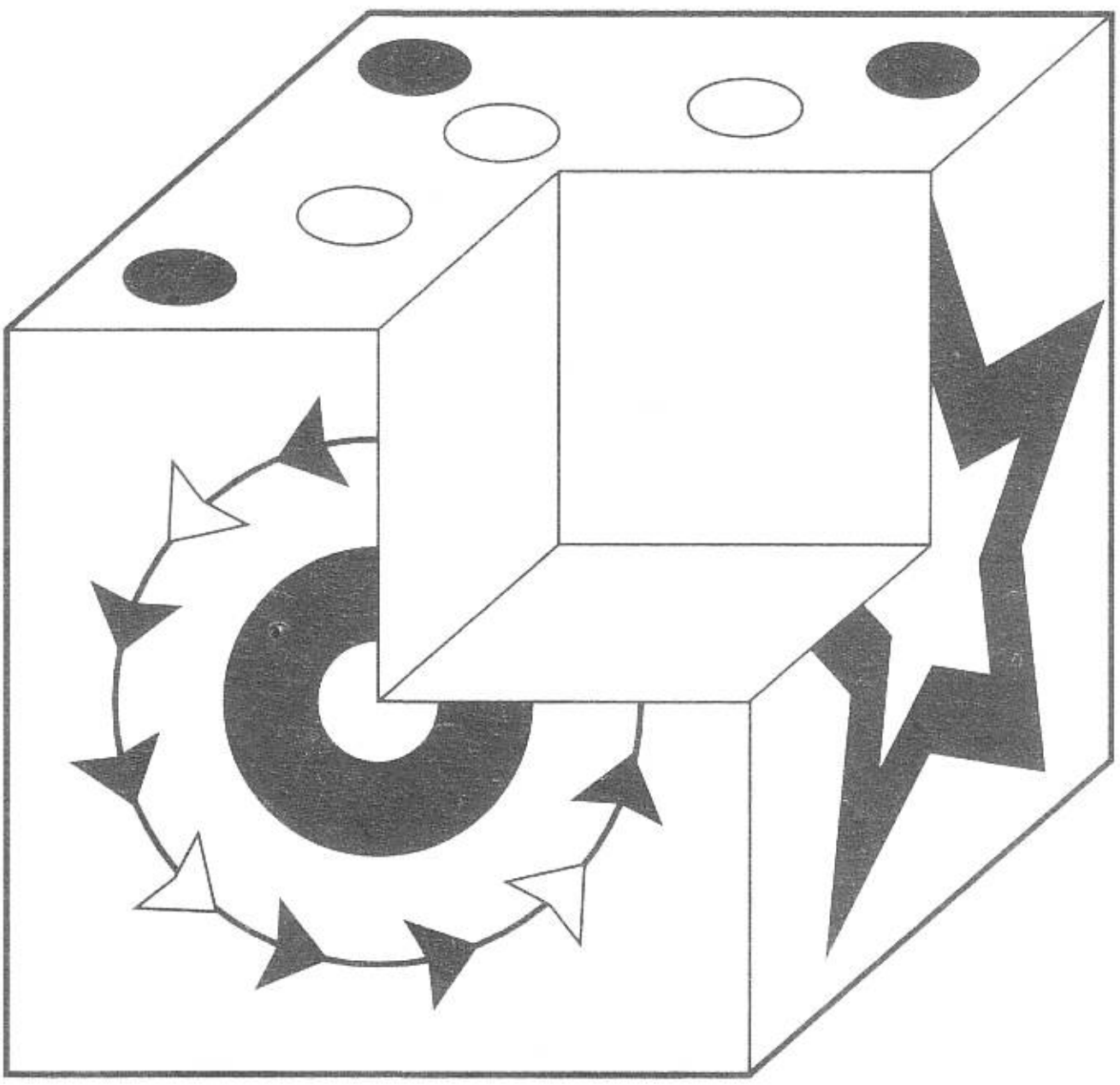

ก

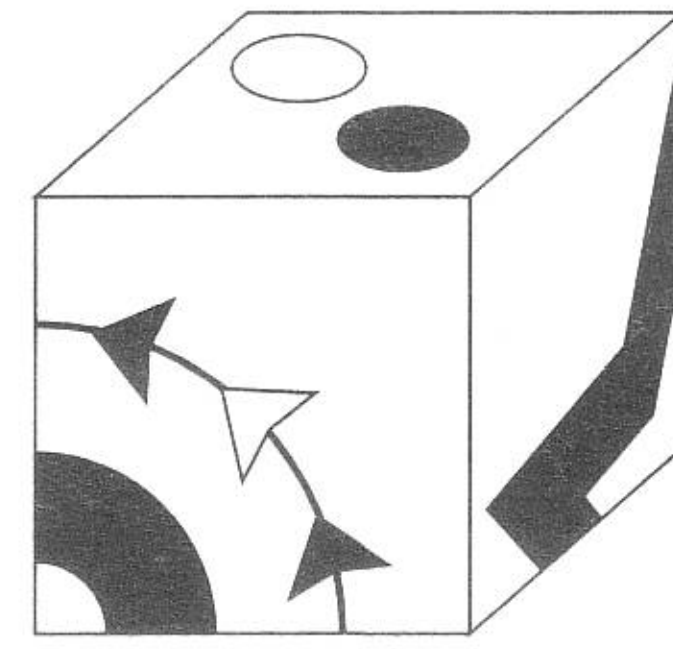

ข

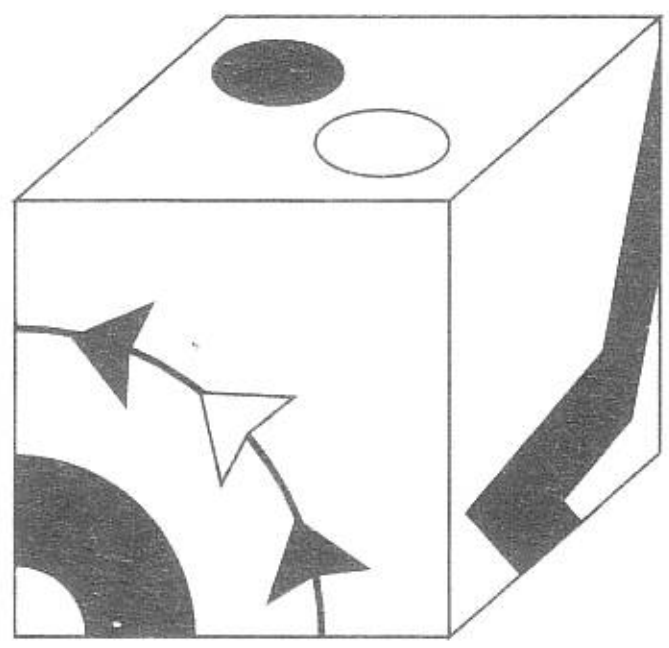

ค

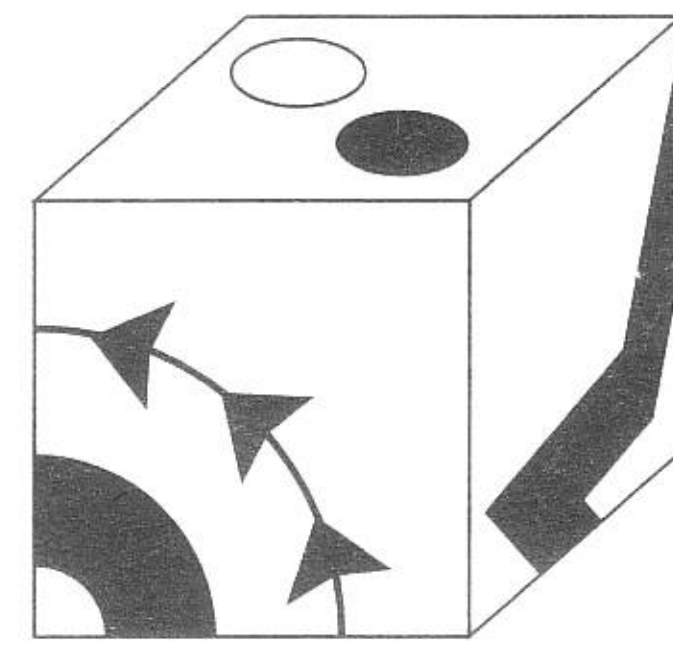

ง

21

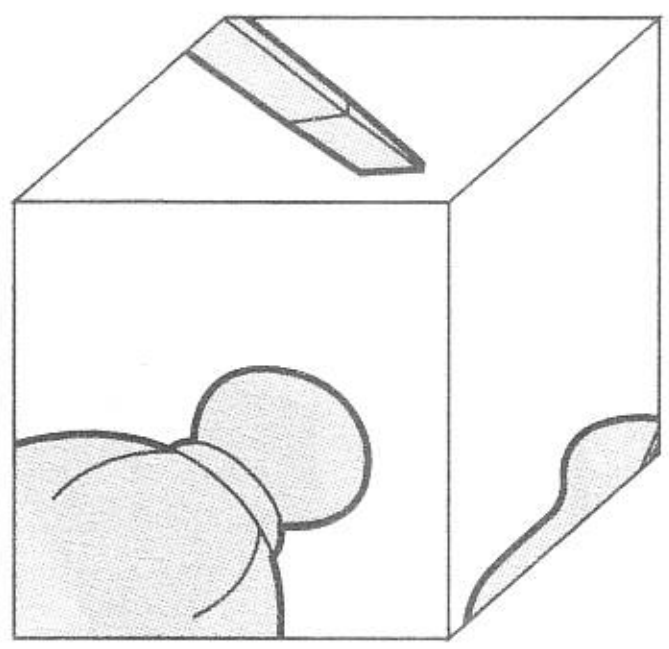
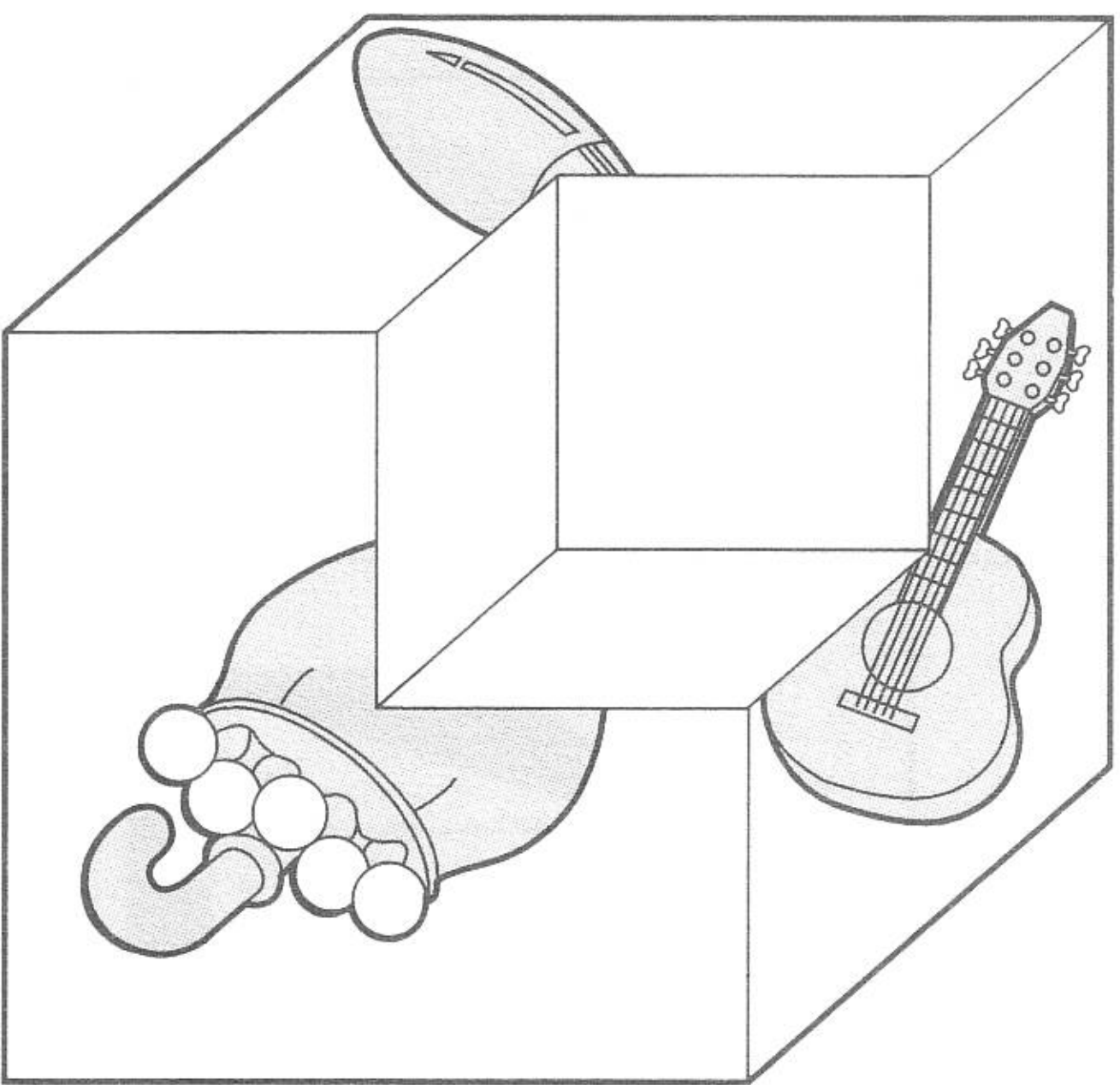

ก

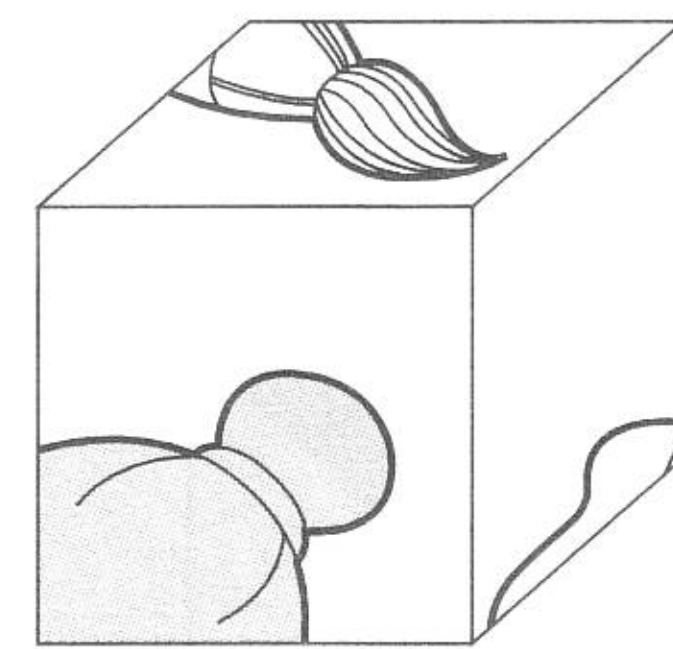

ข

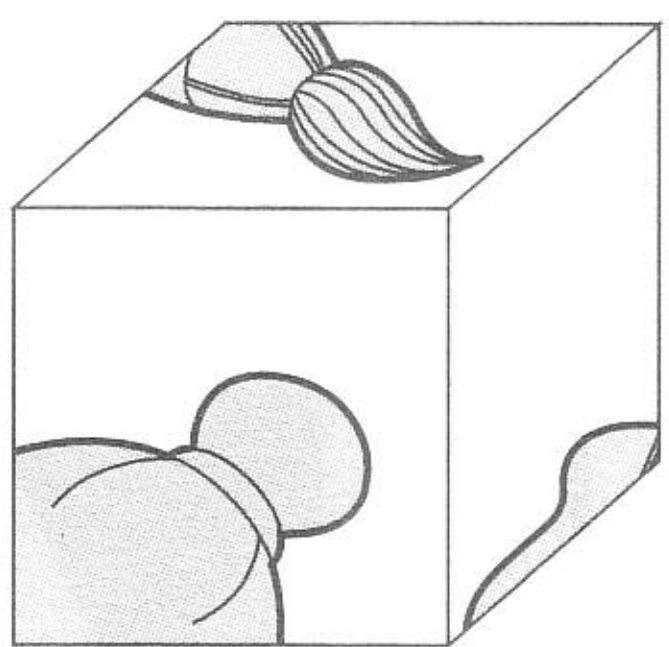

ค

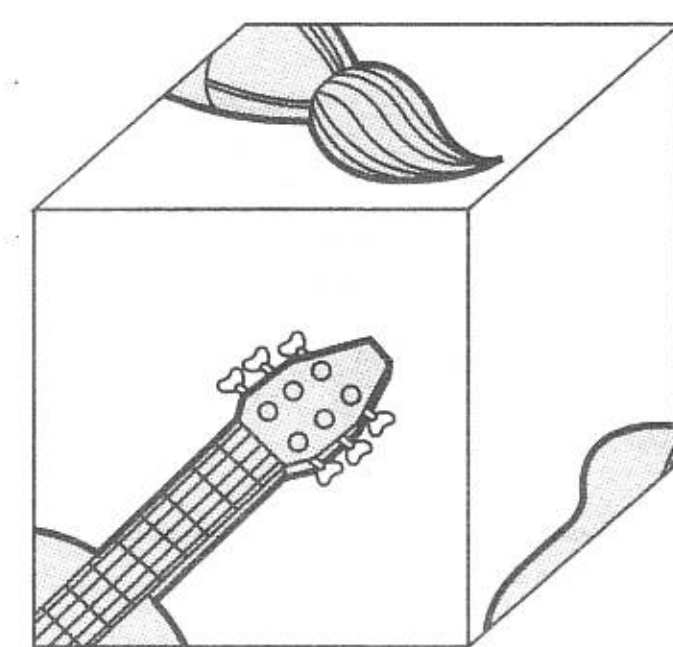

ง

22

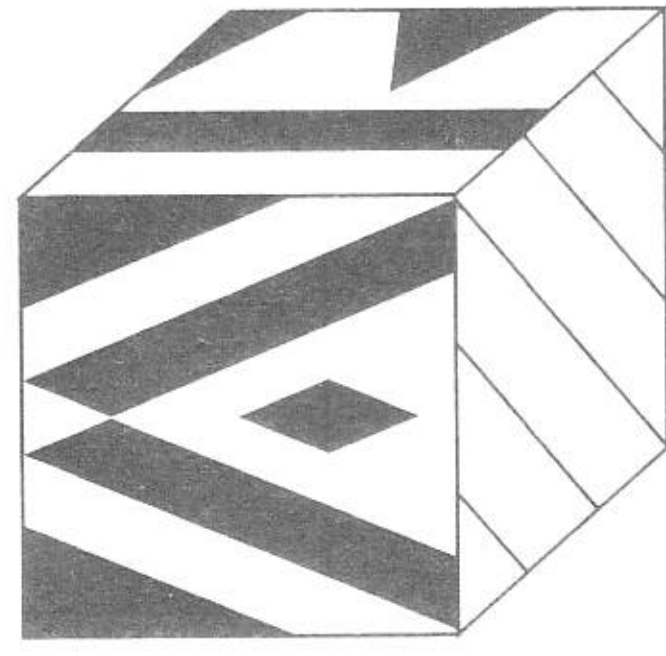
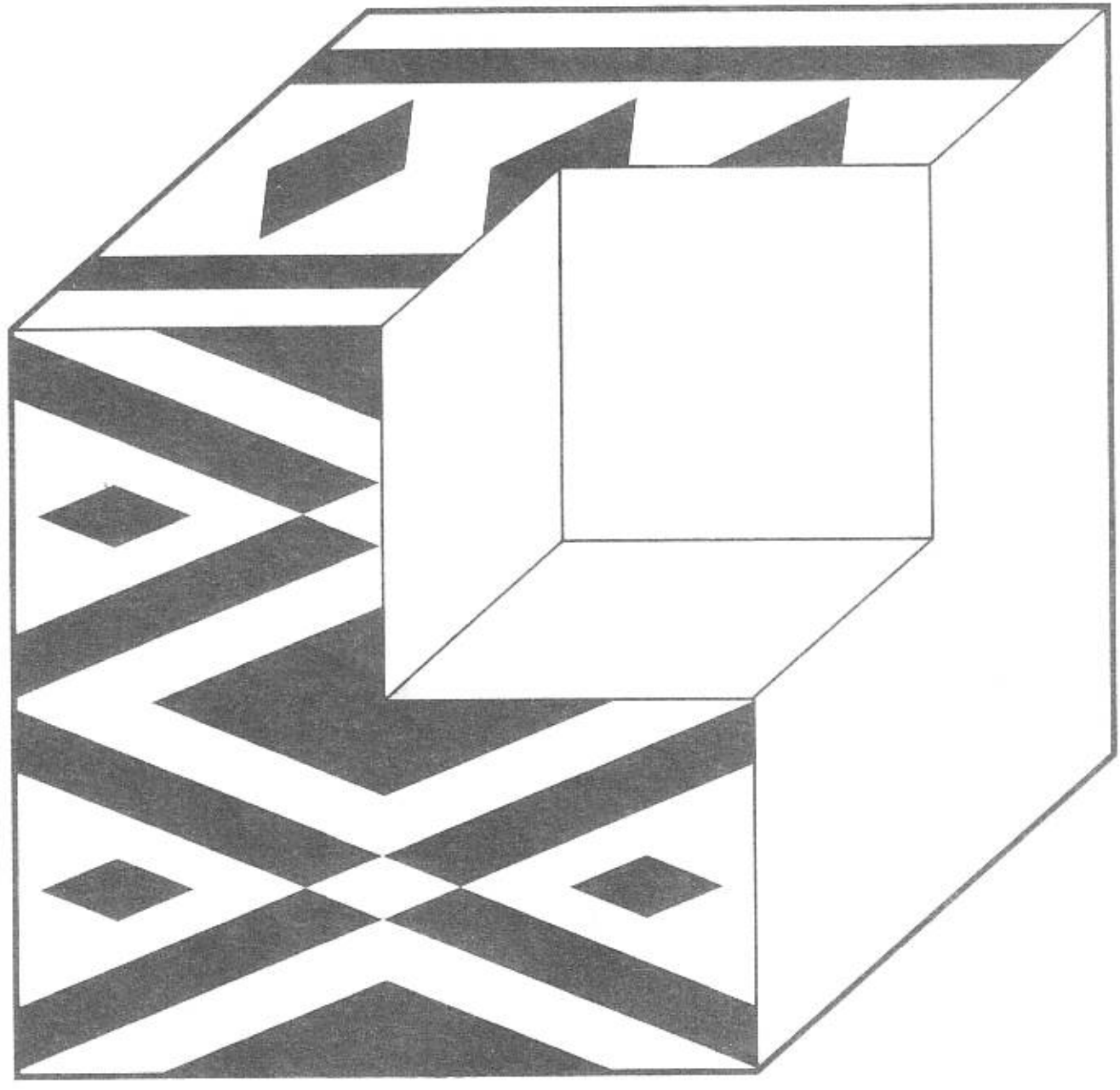

ก

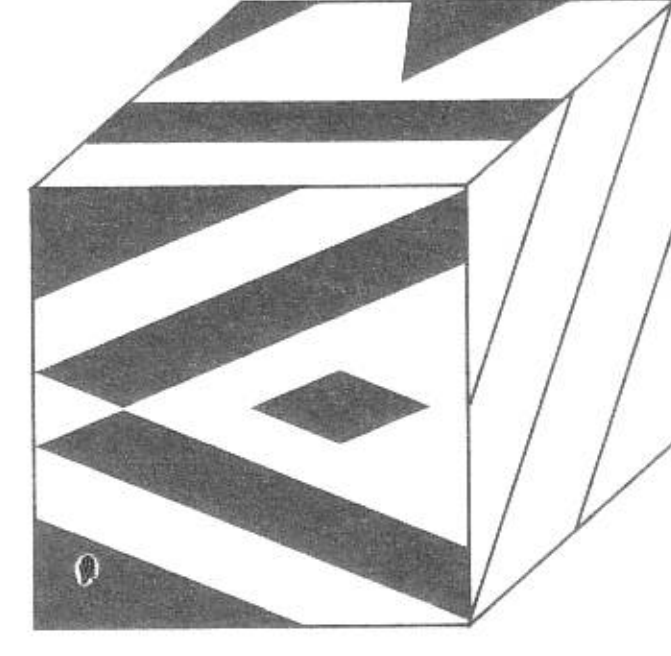

ข

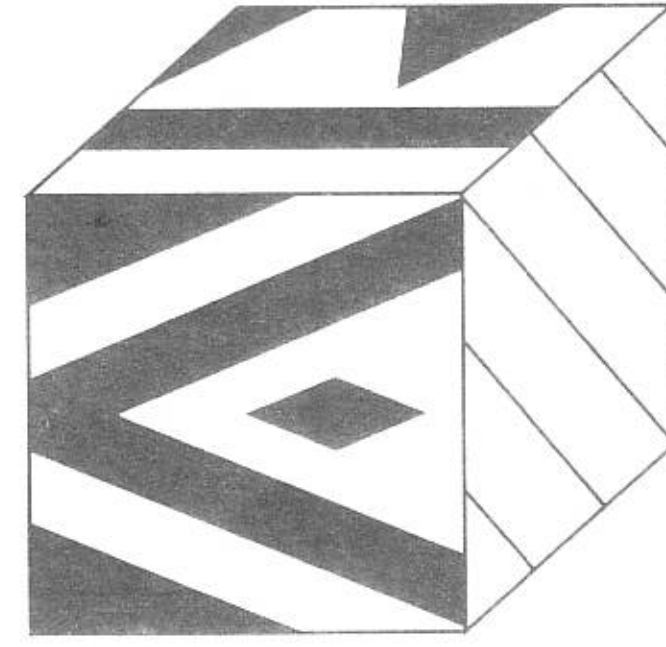

ค

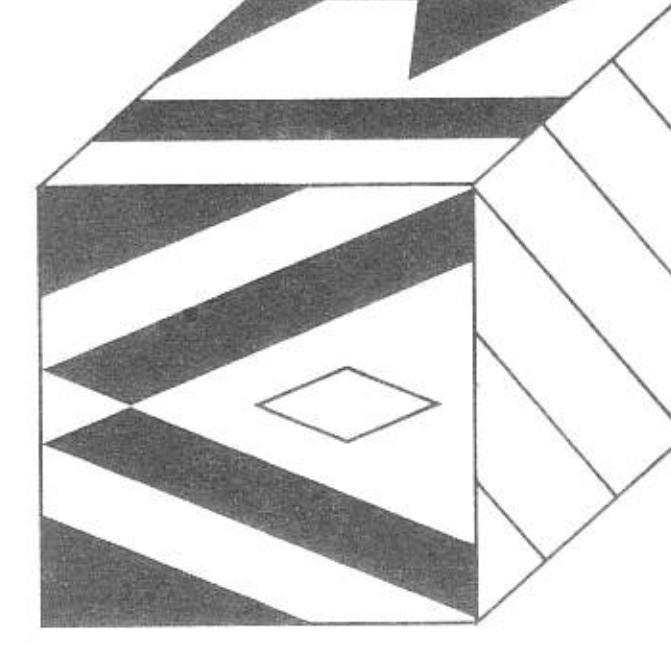

ง

23

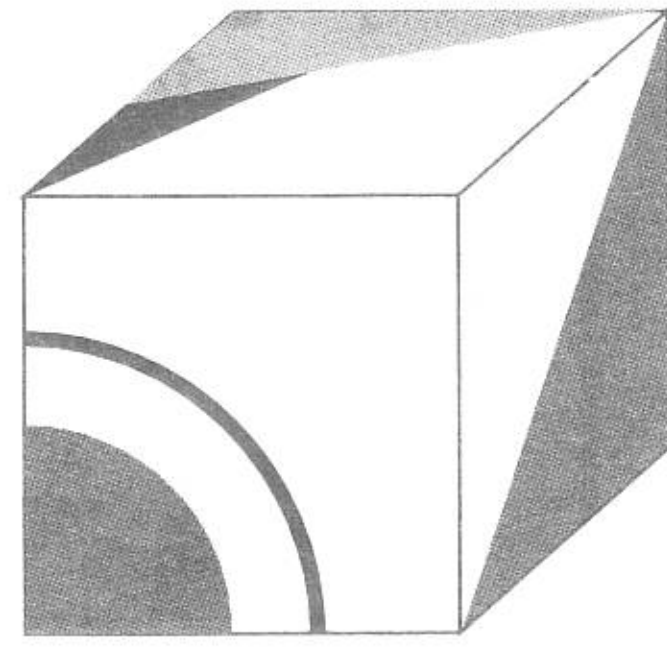
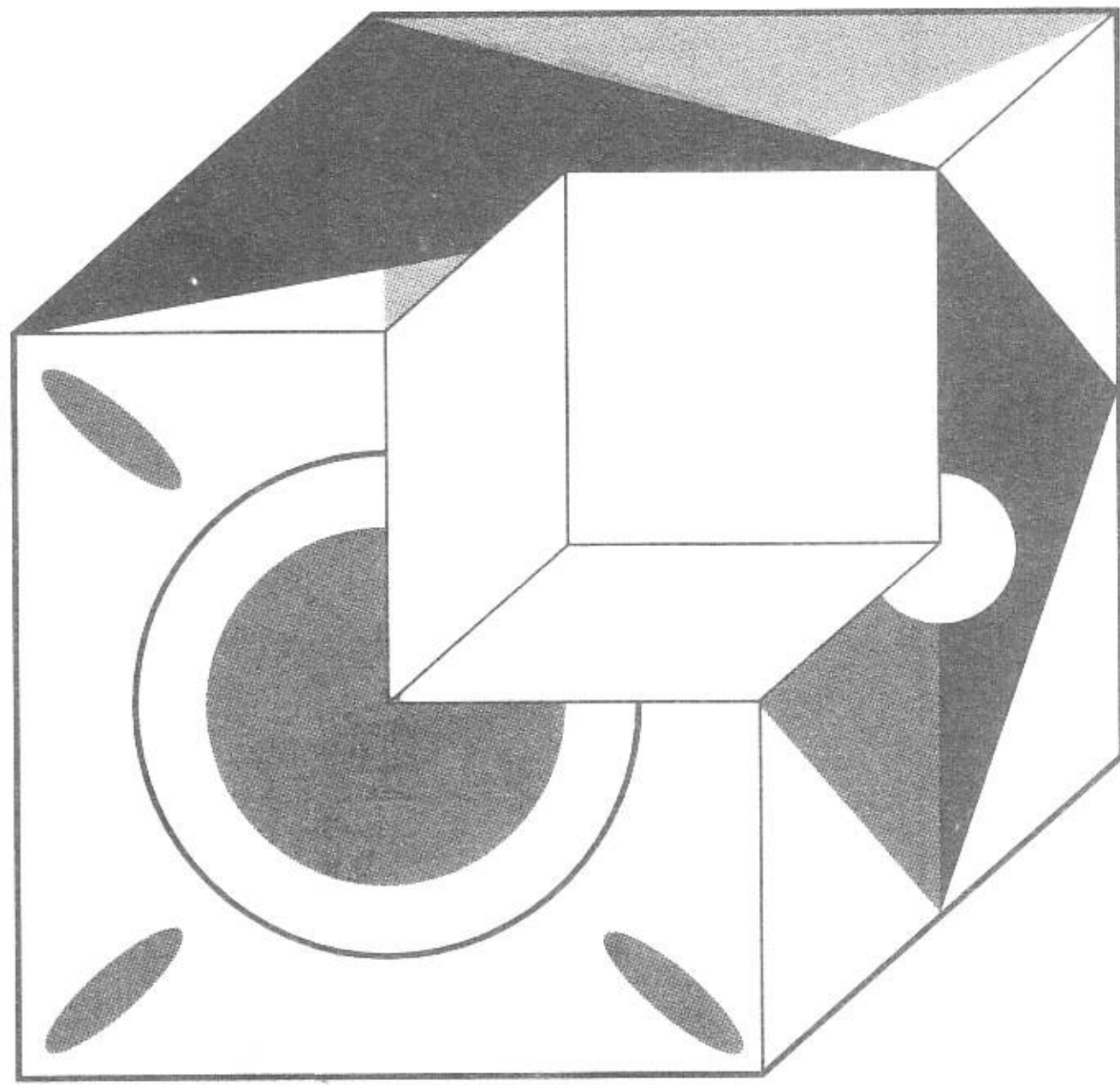

ก

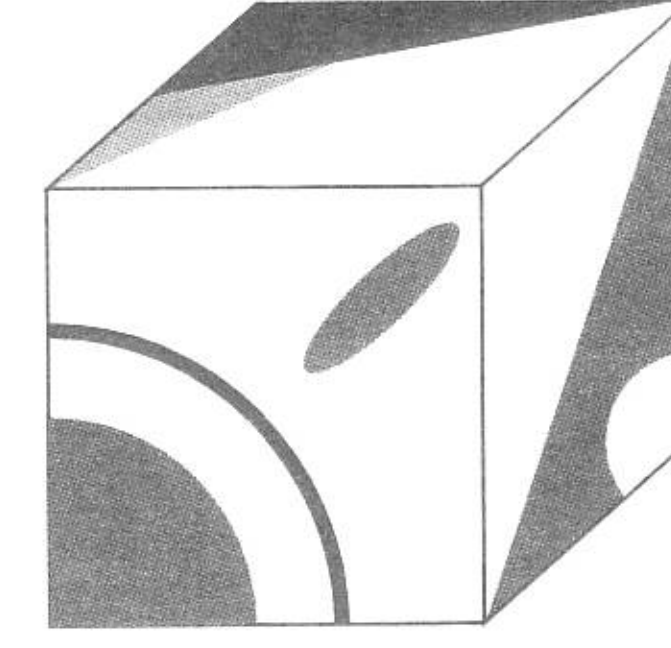

ข

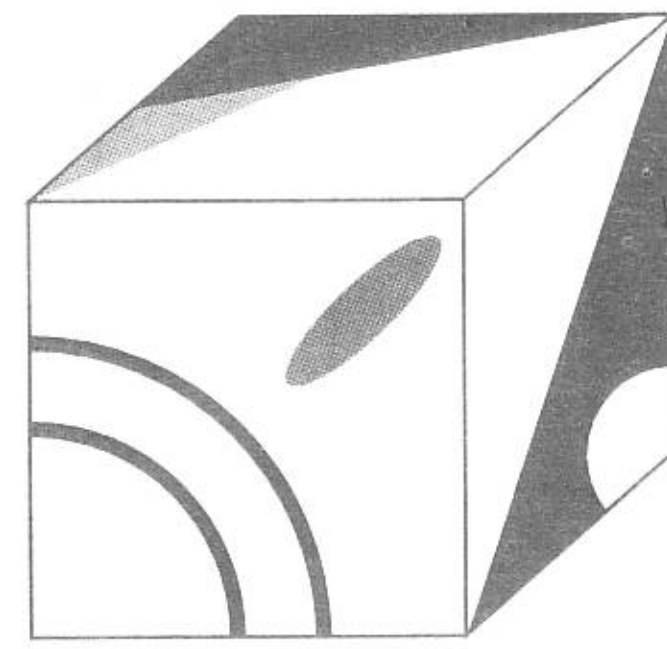

ค

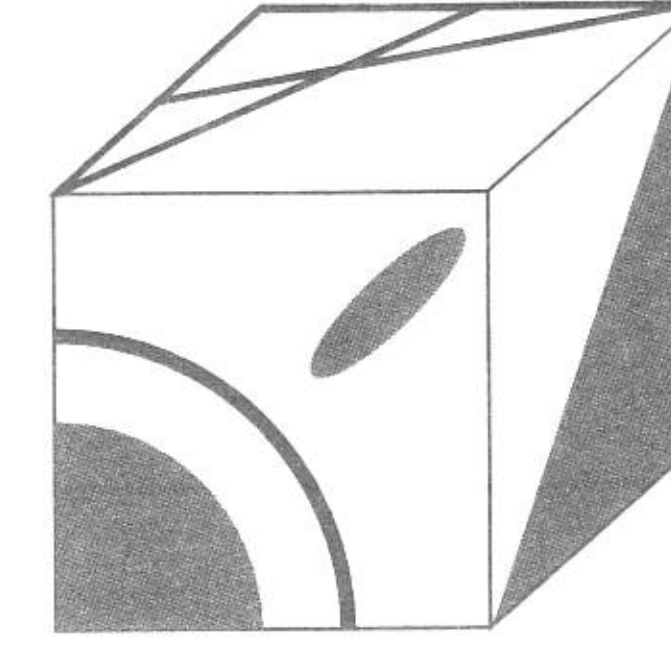

ง

24

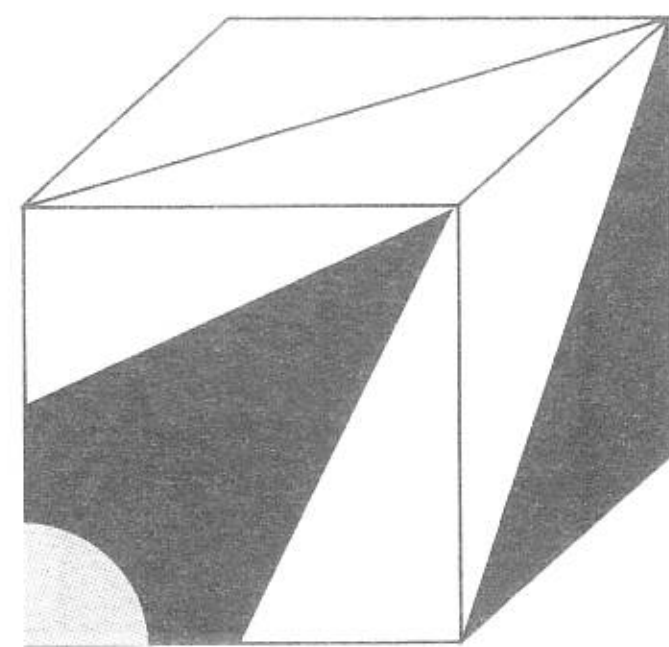
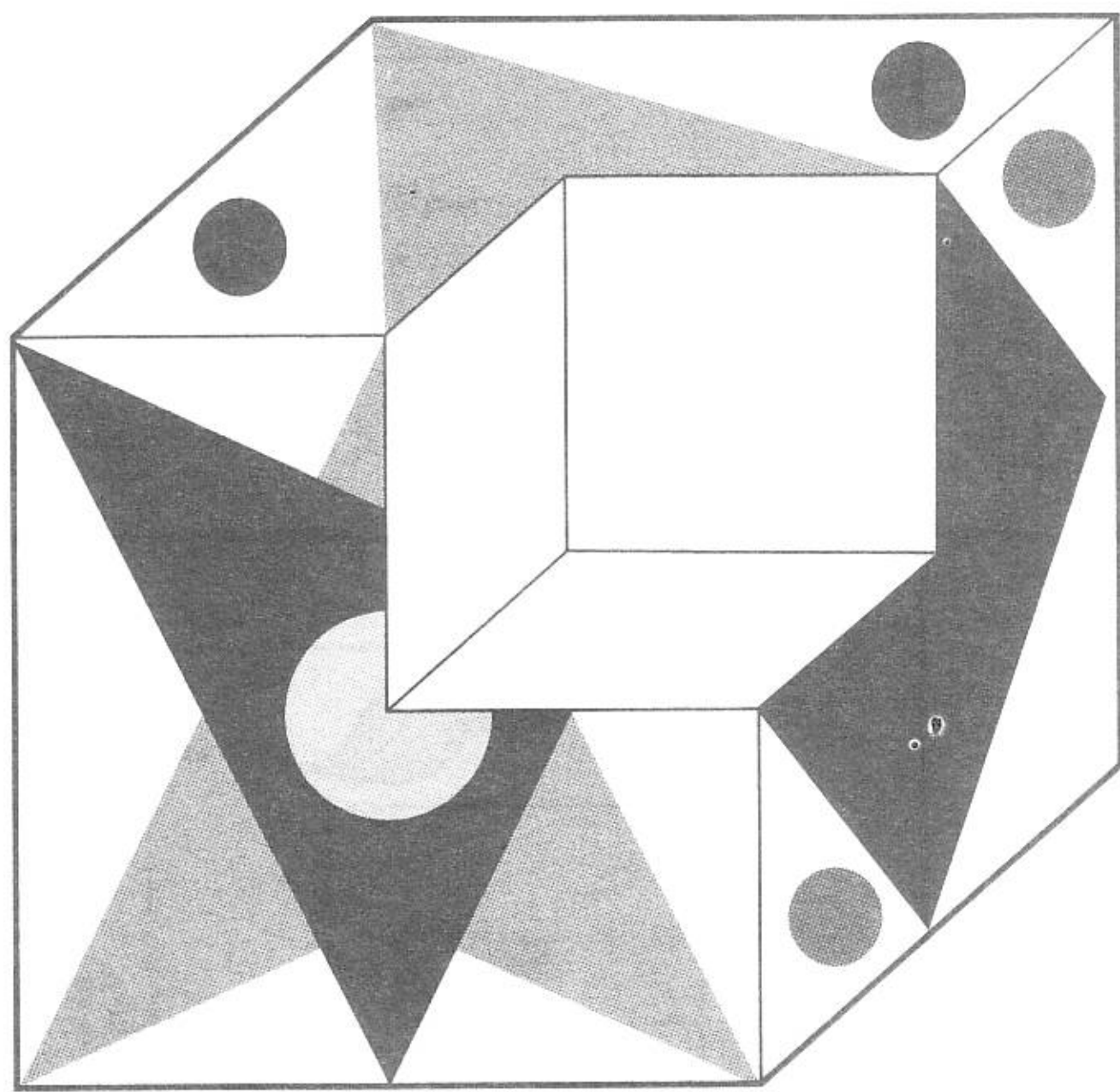

ก

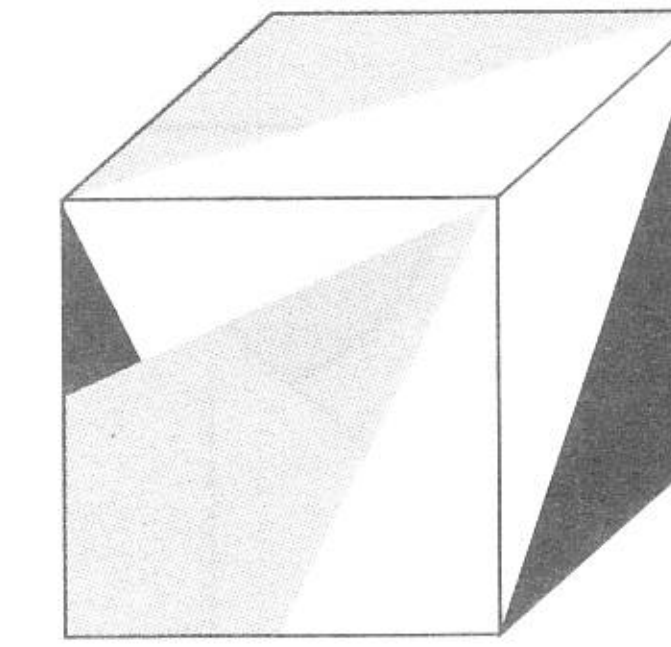

ข

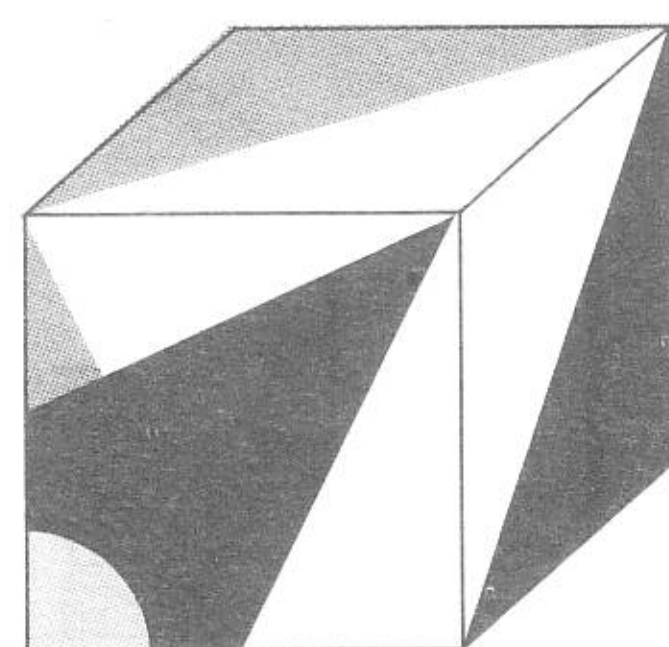

ค

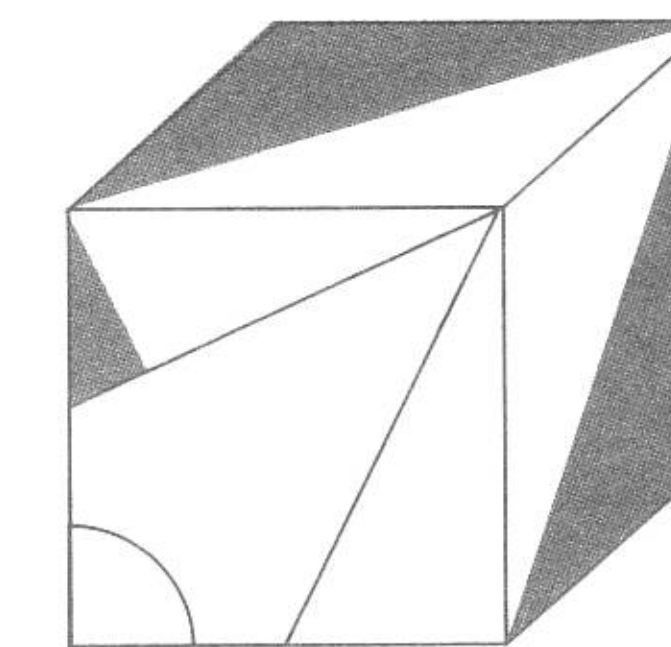

ง

จงขีด ✓ ภาพที่มีลายเข้าชุดกับภาพด้านบน

1

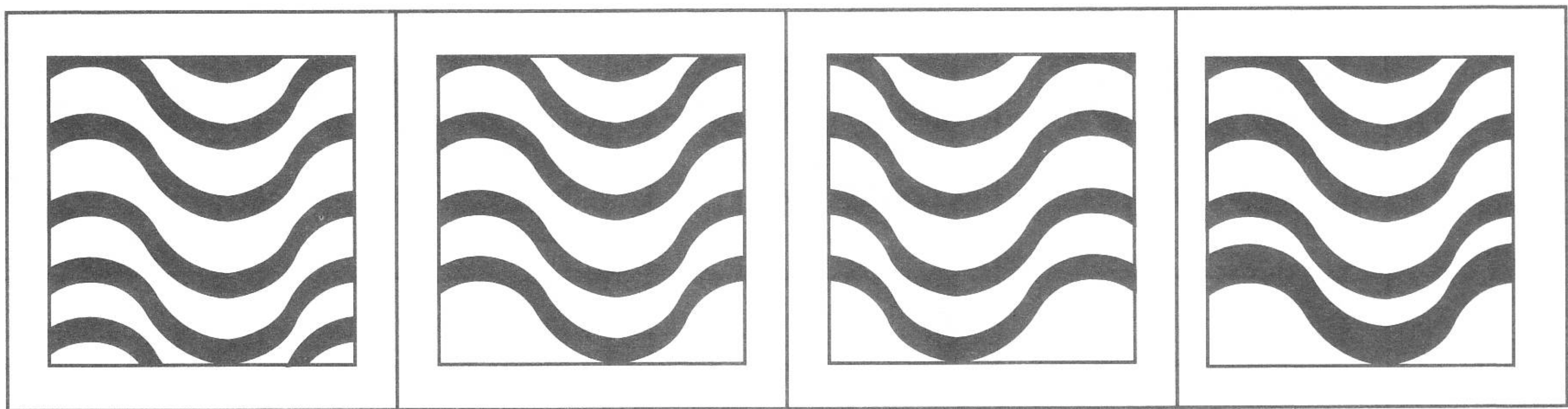
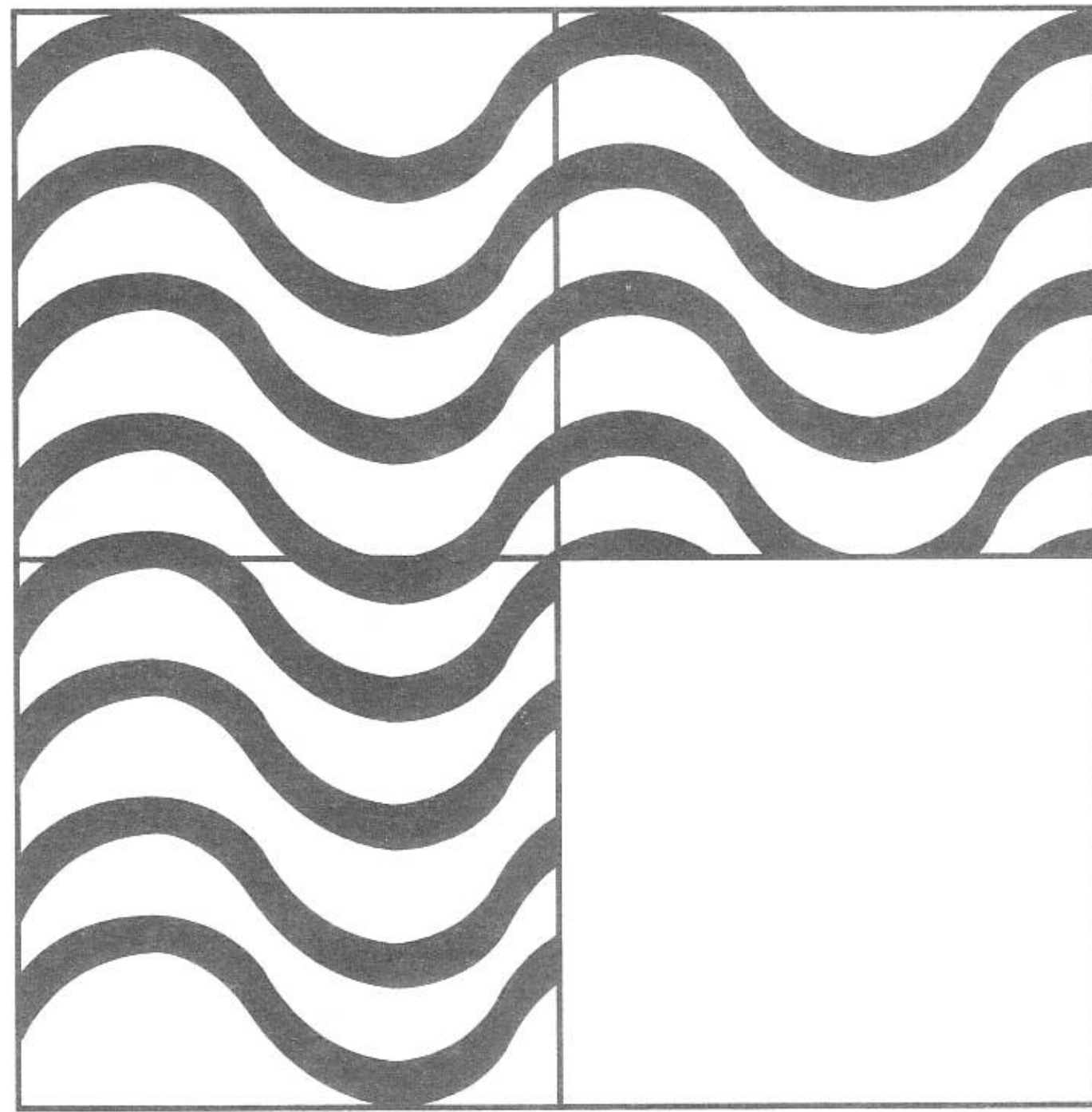

ก

ข

ค

ง

2

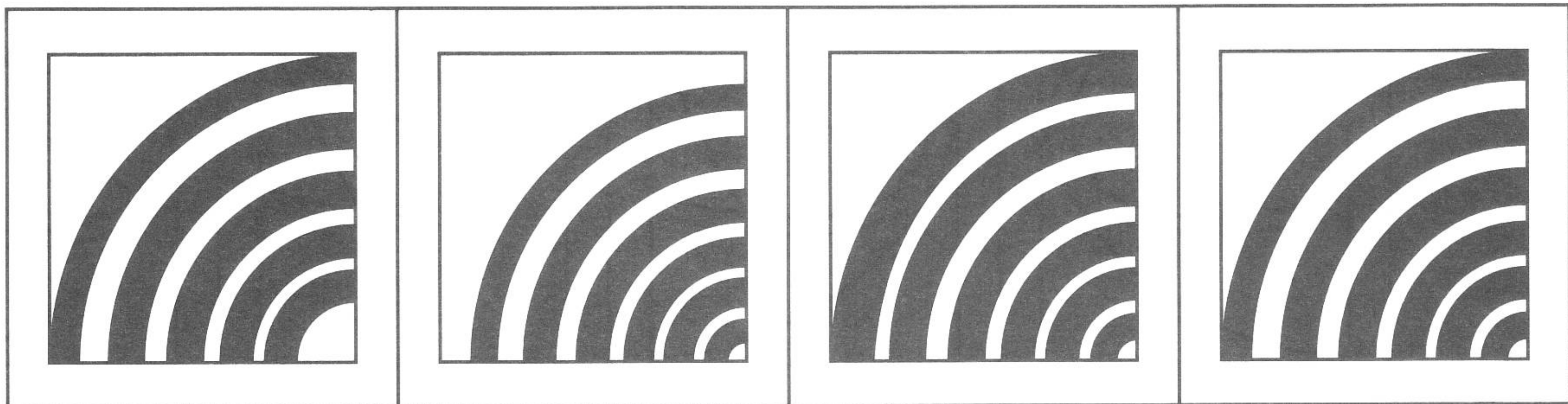
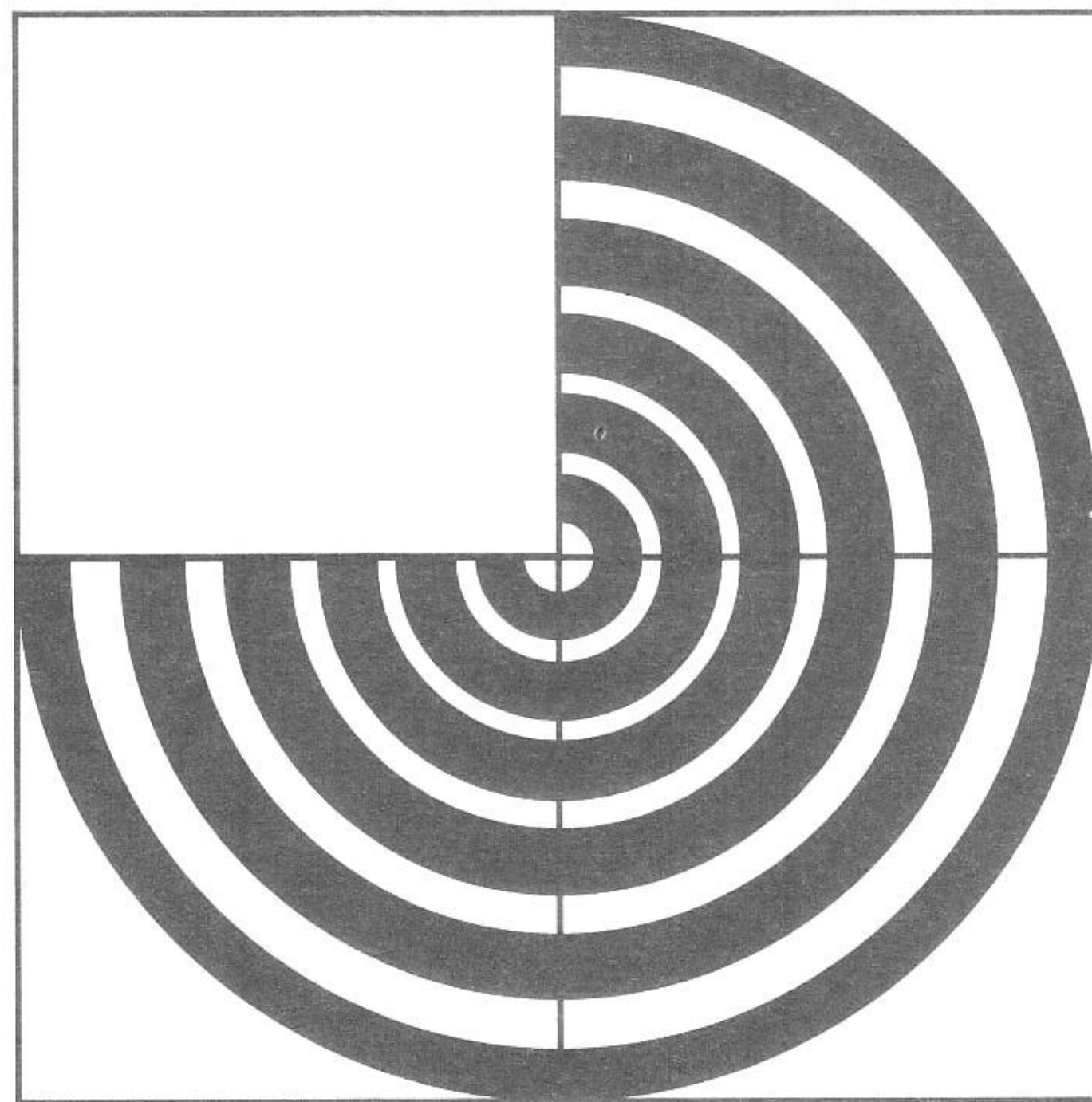

ก

ข

ค

ง

3

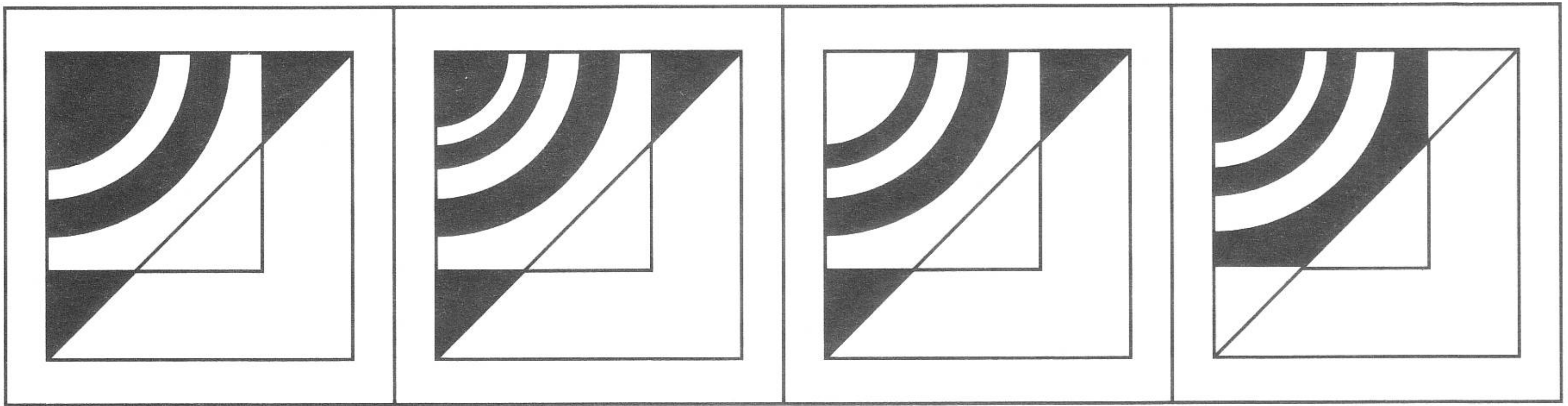
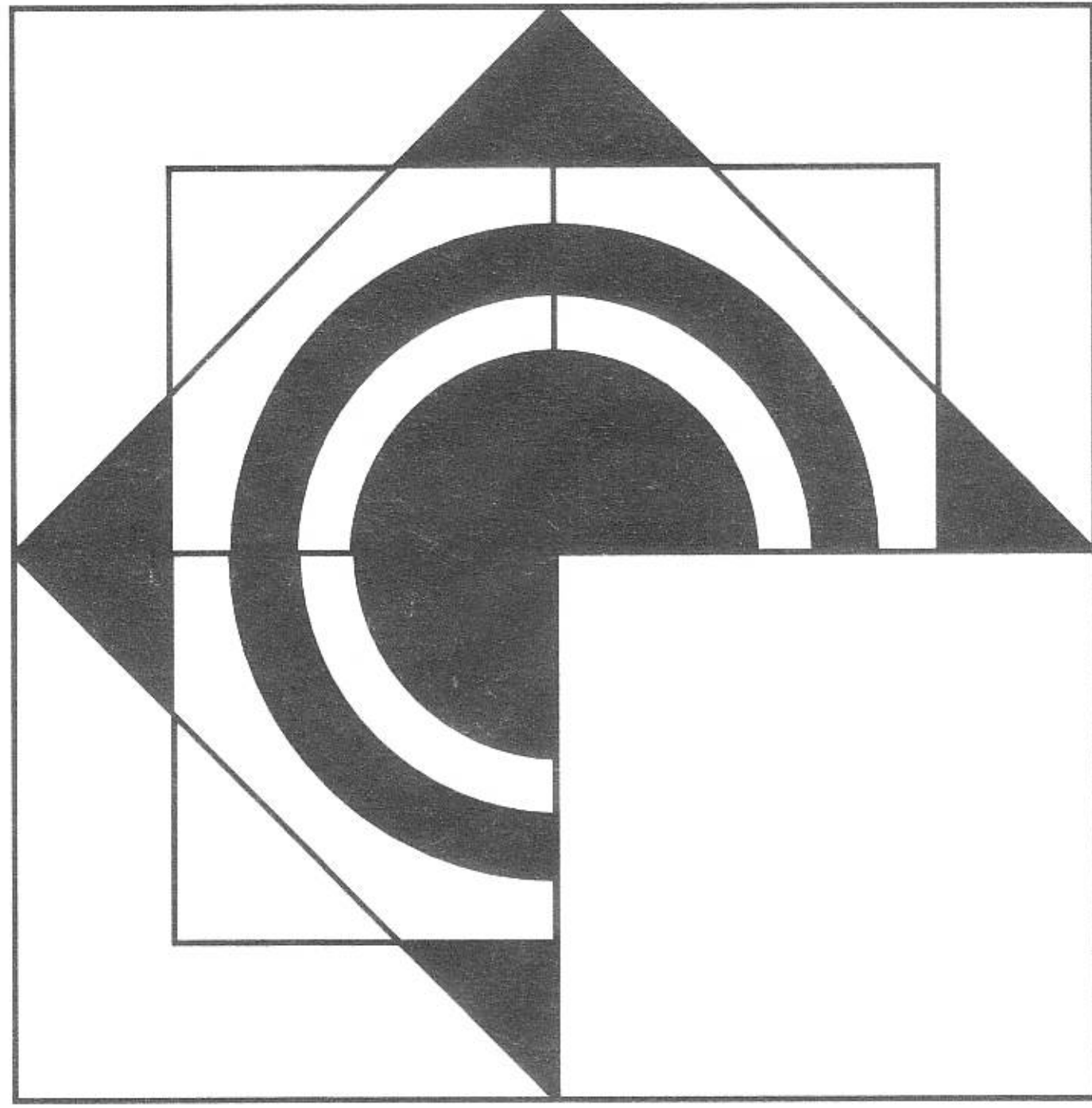

ก

ข

ค

ง

4

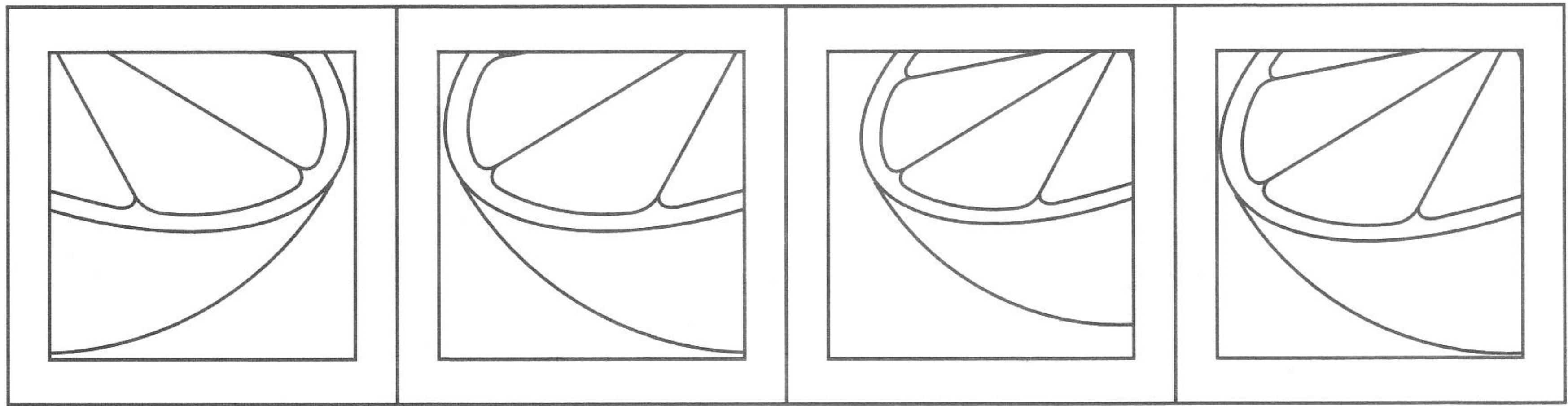
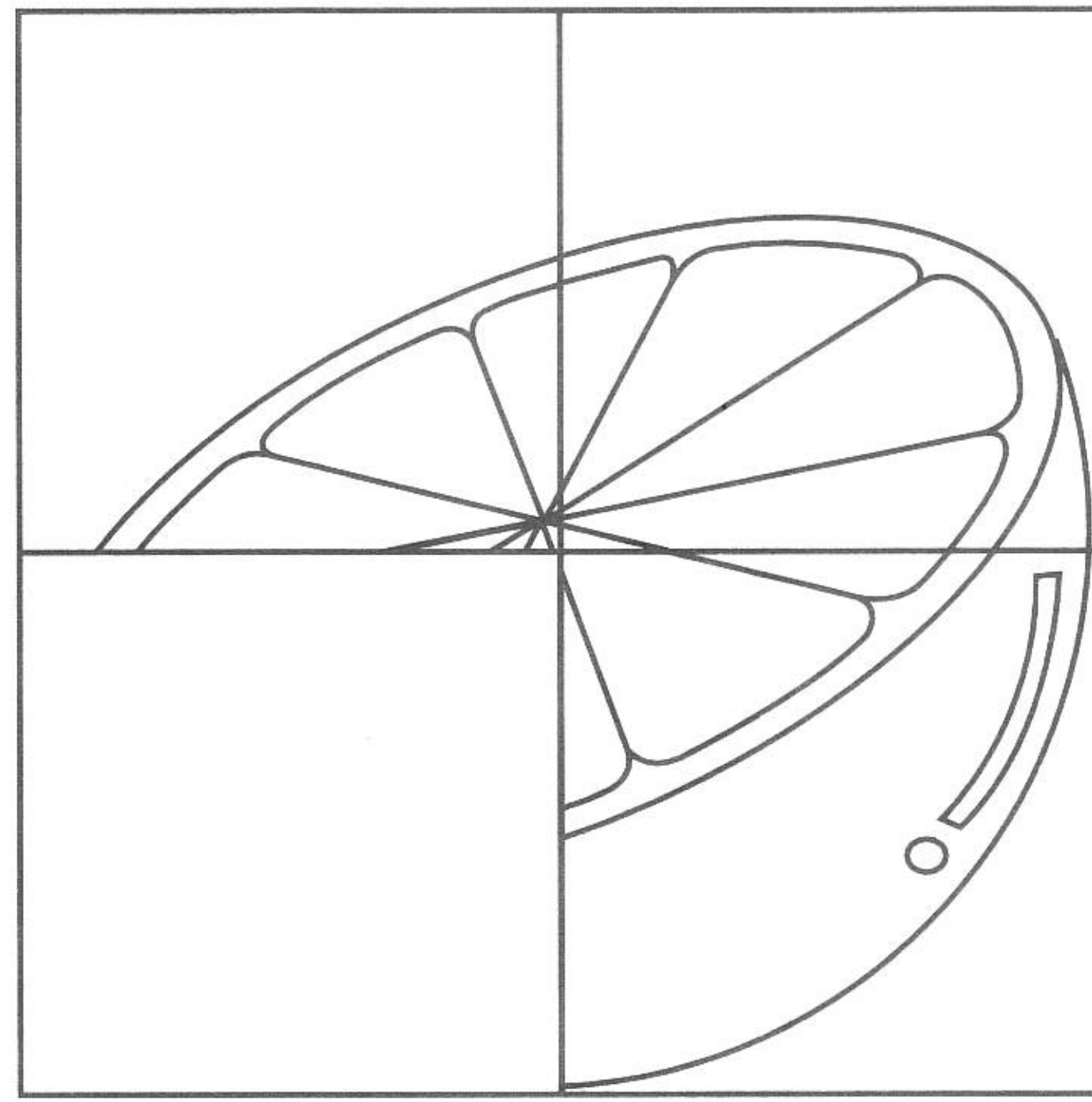

ก

ข

ค

ง

5

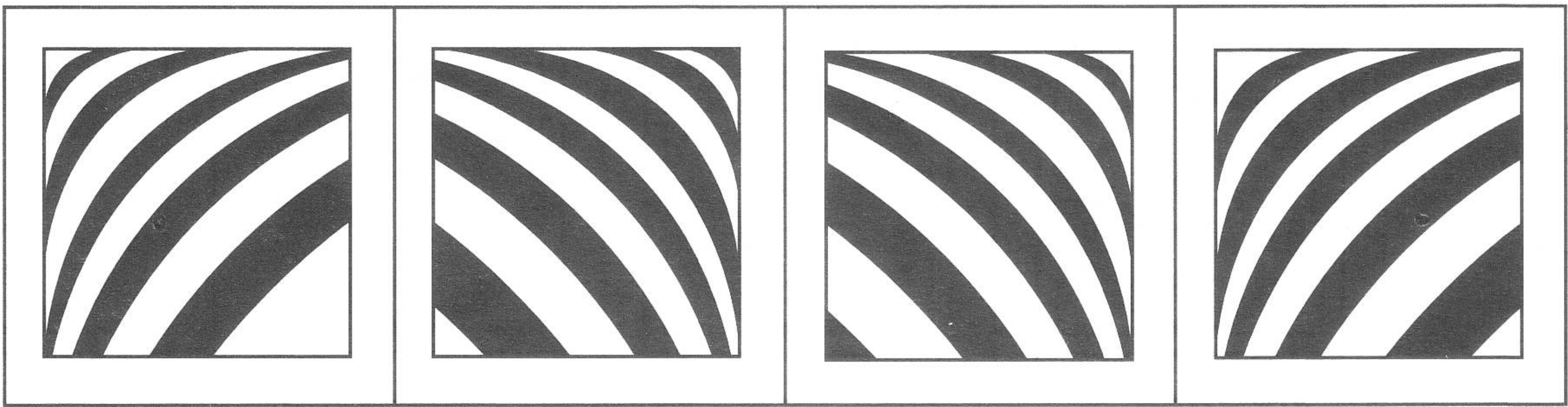
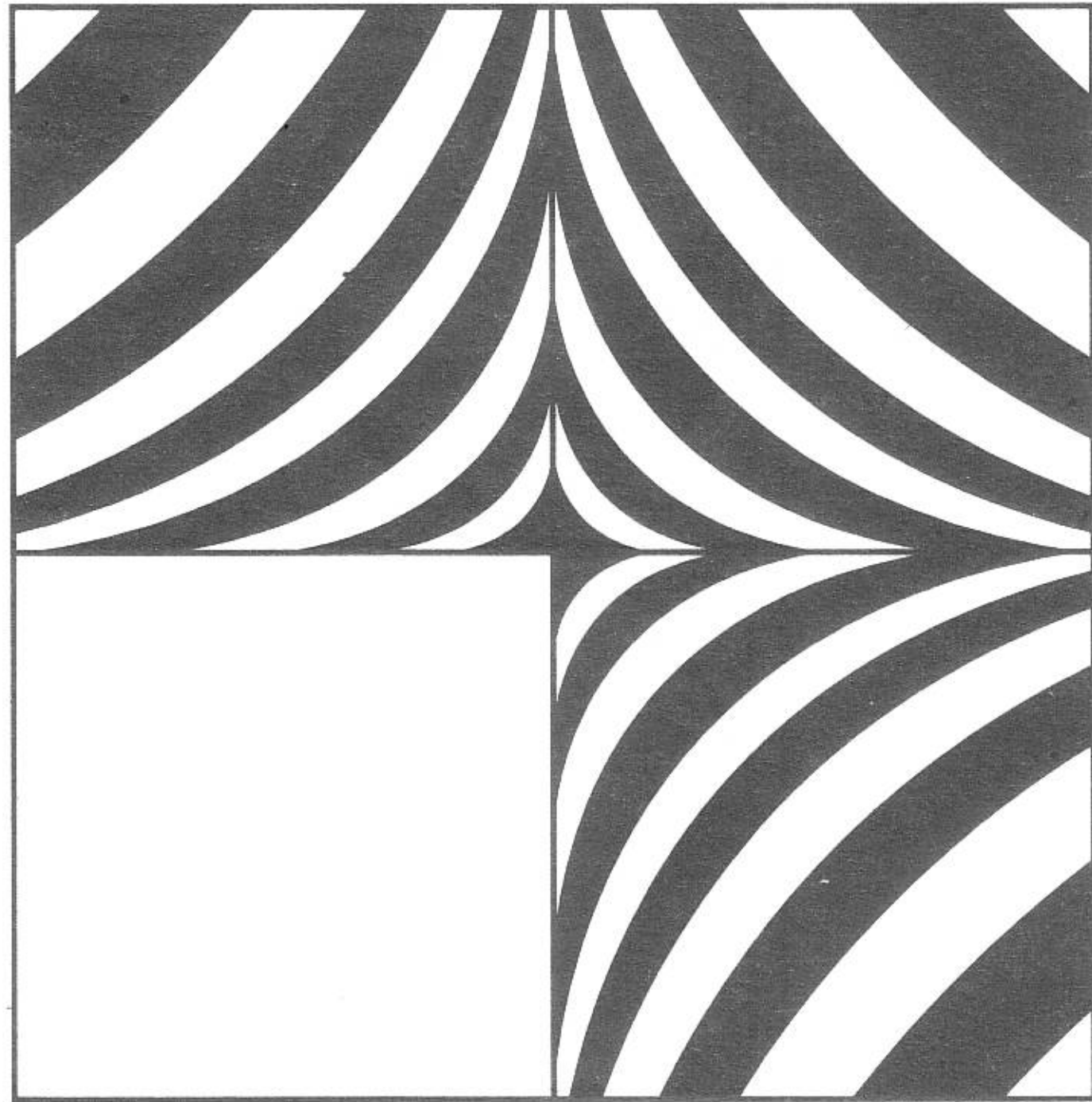

ก

ข

ค

ง

6

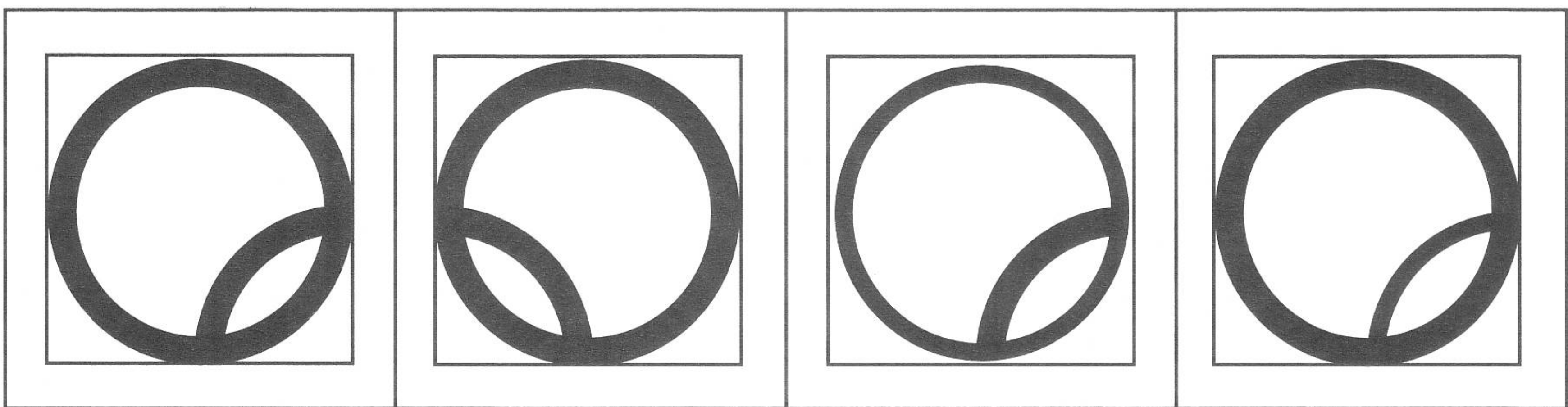
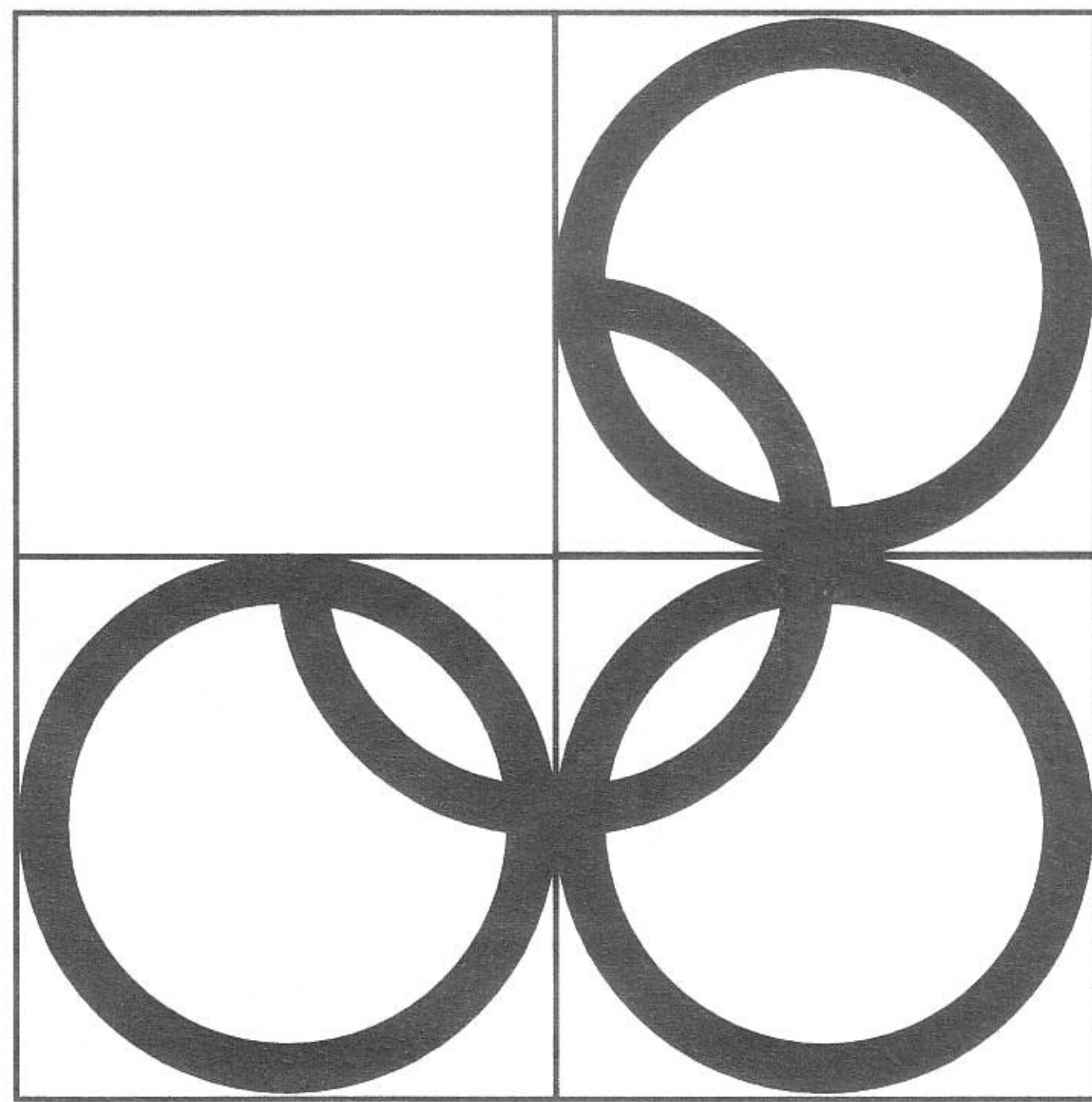

ก

ข

ค

ง

7

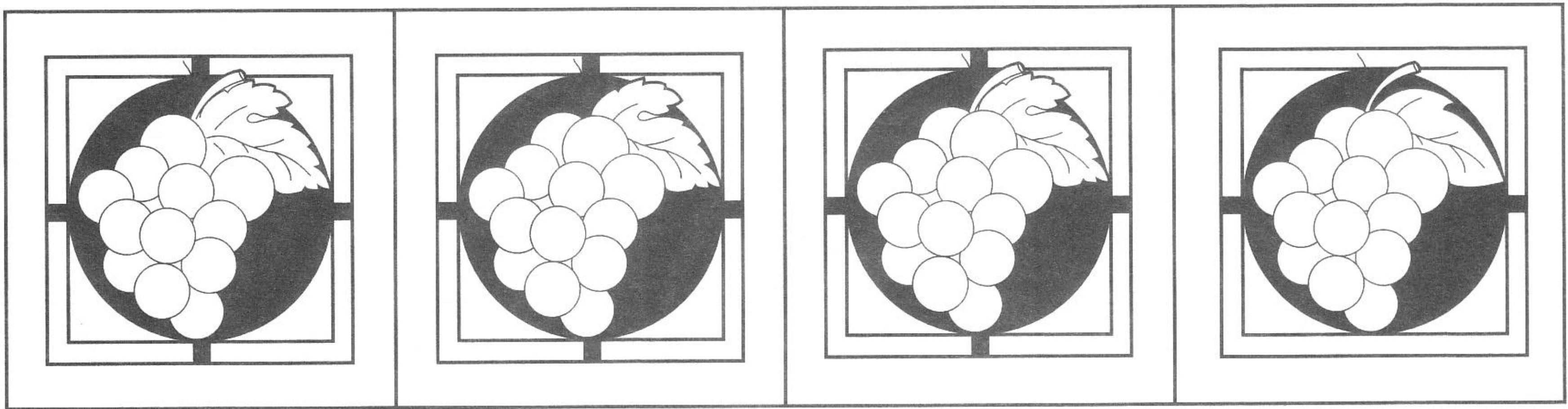
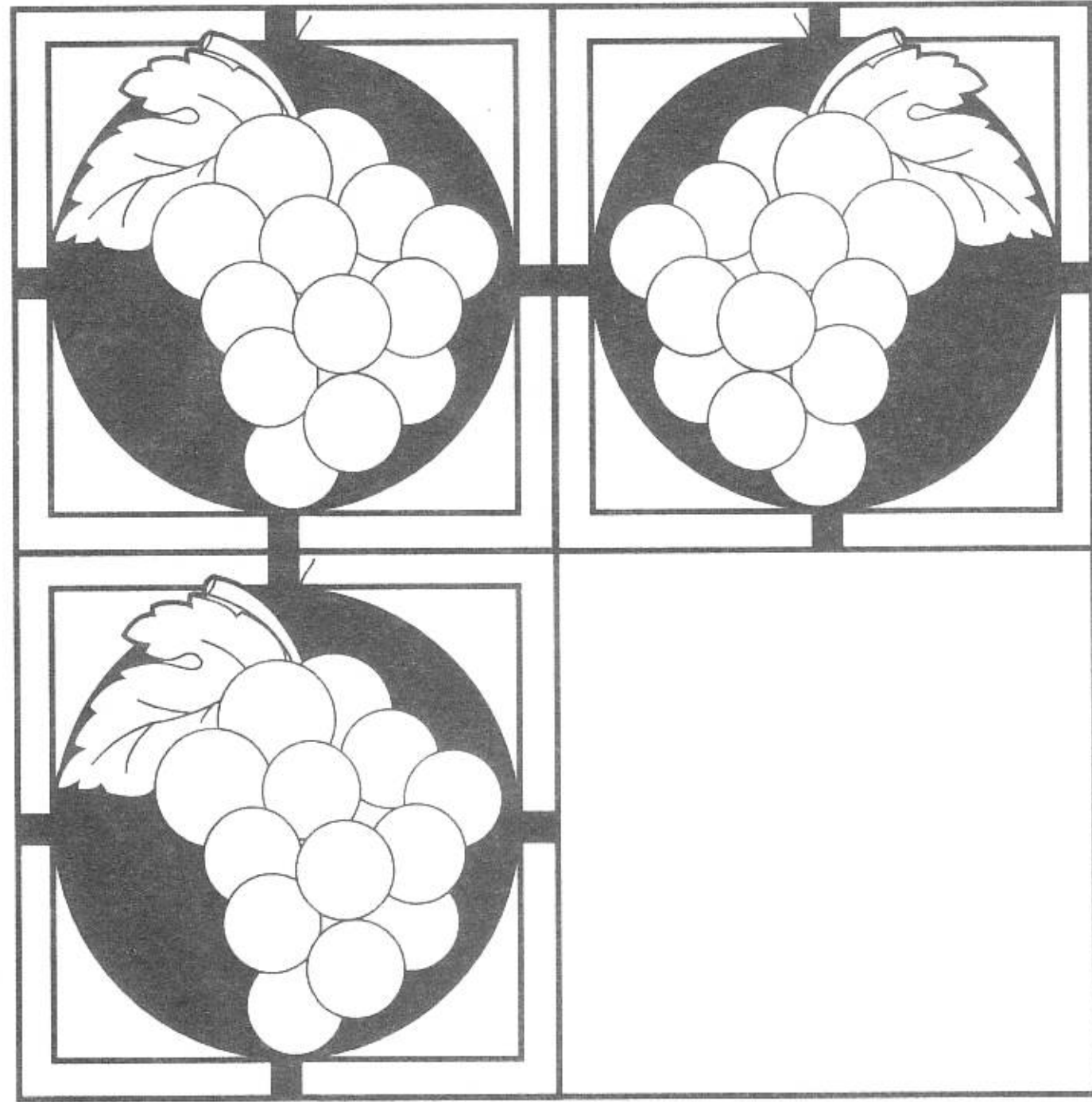

ก

ข

ค

ง

8

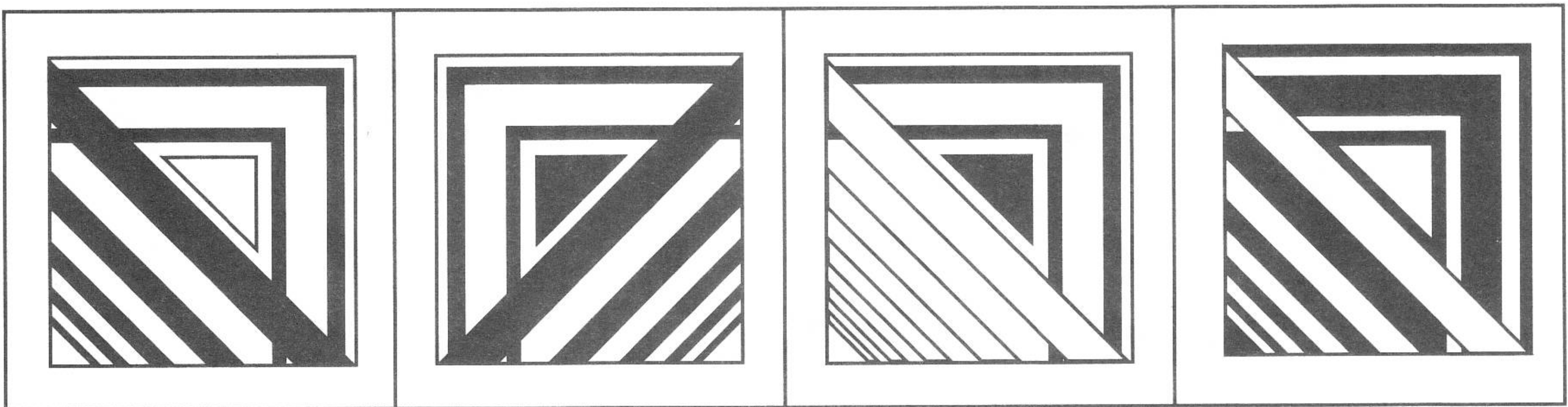
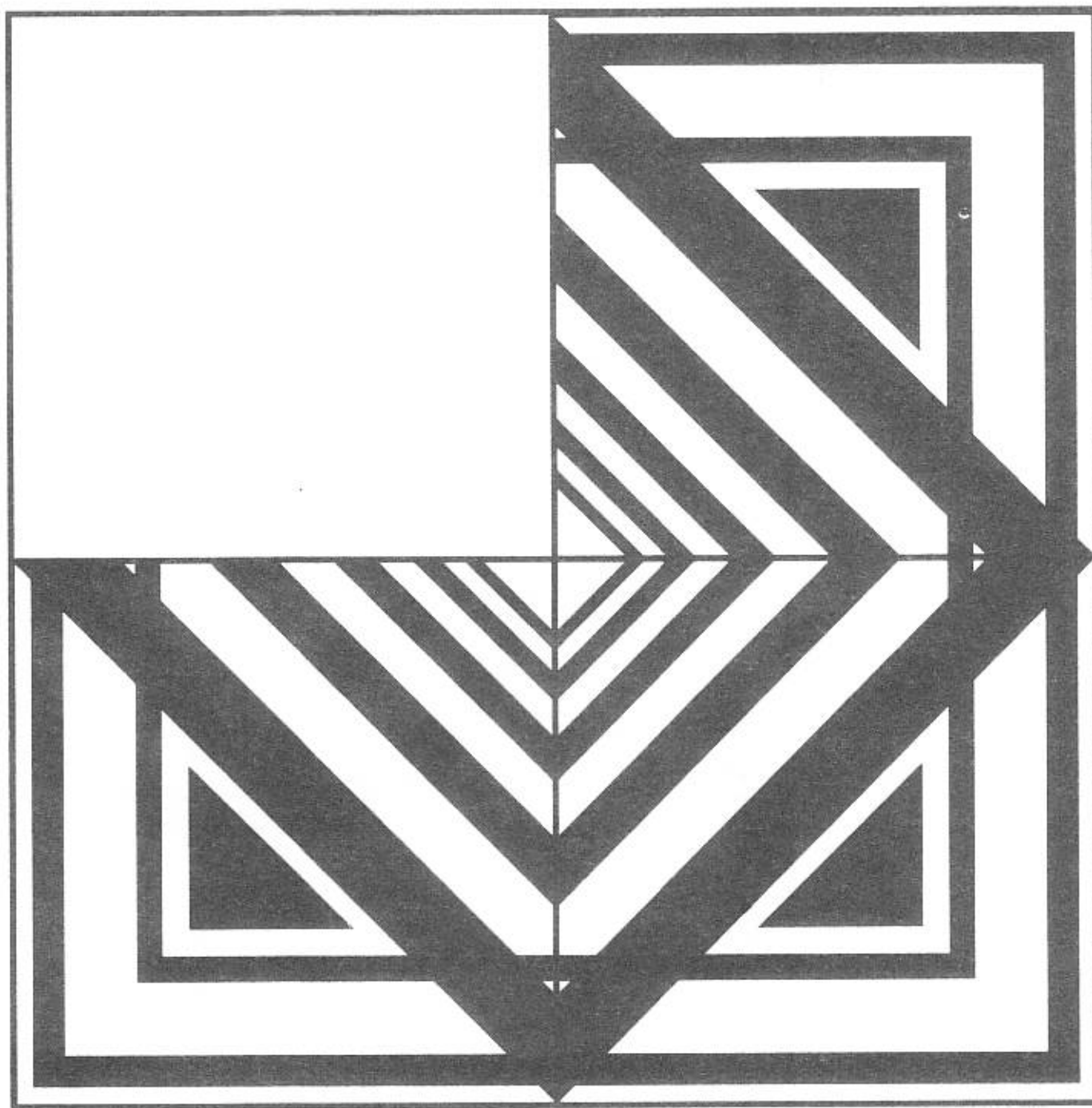

ก

ข

ค

ง

9

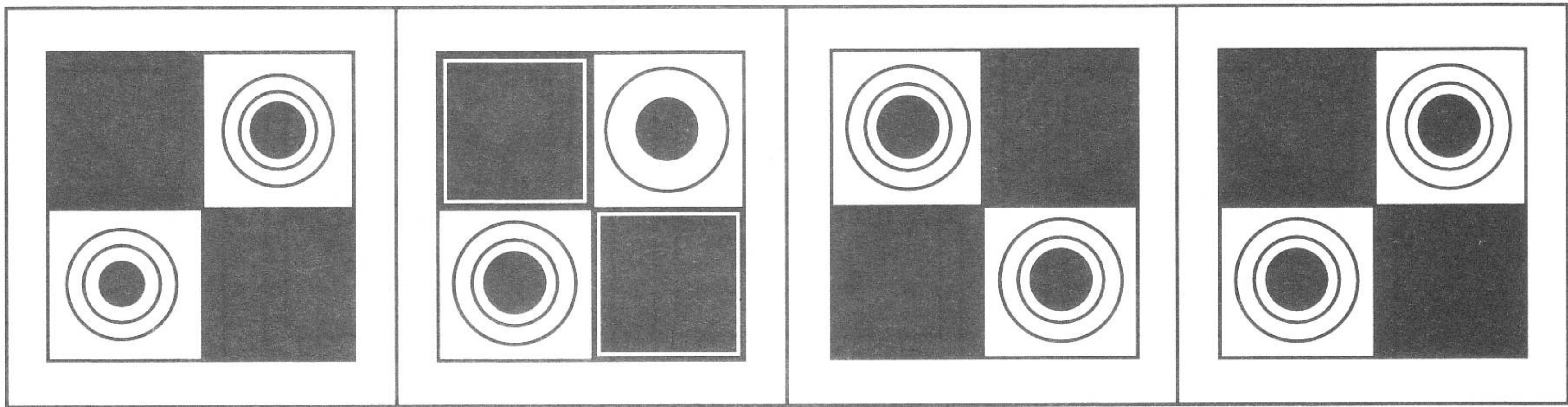
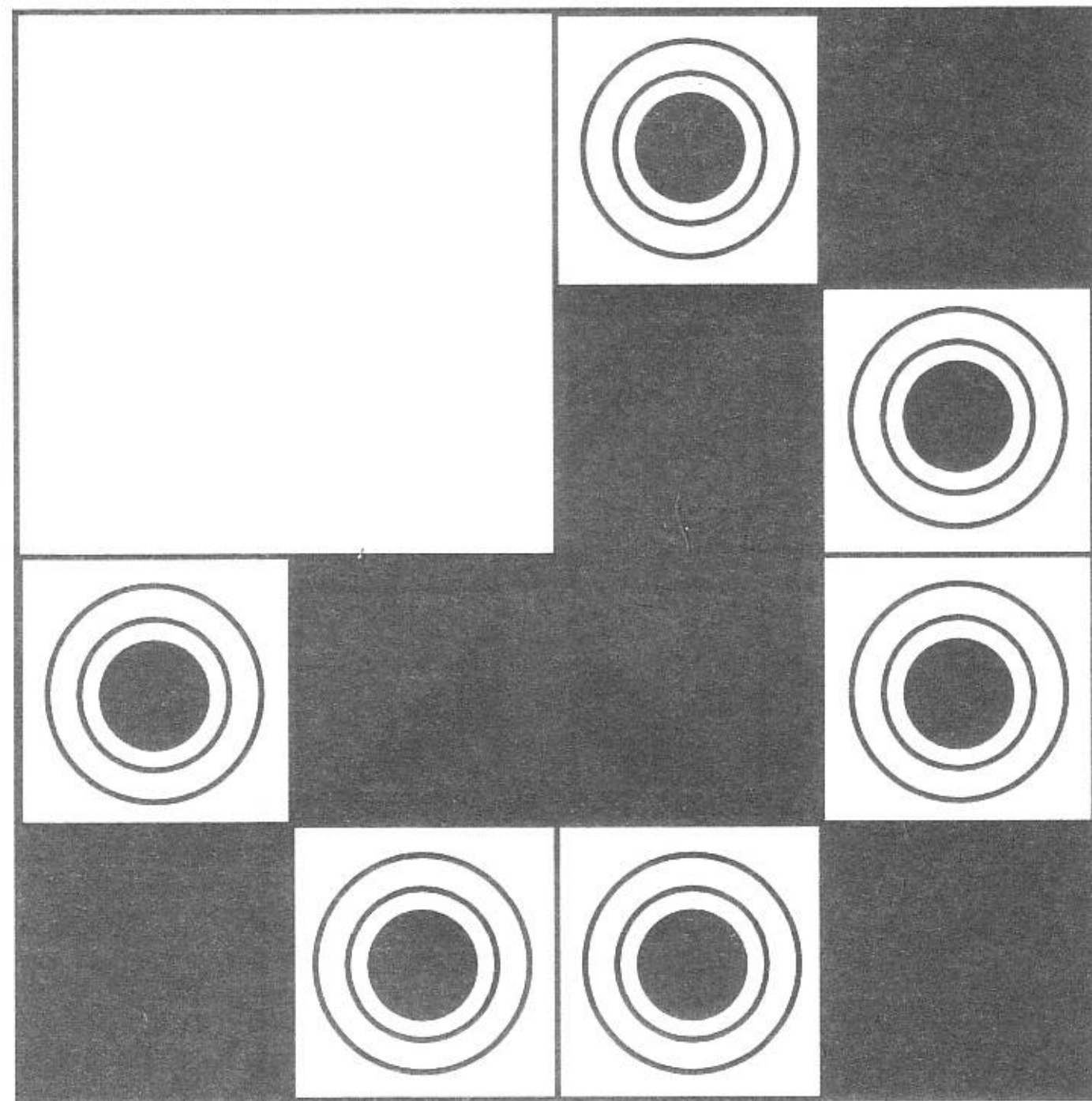

ก

ข

ค

ง

10

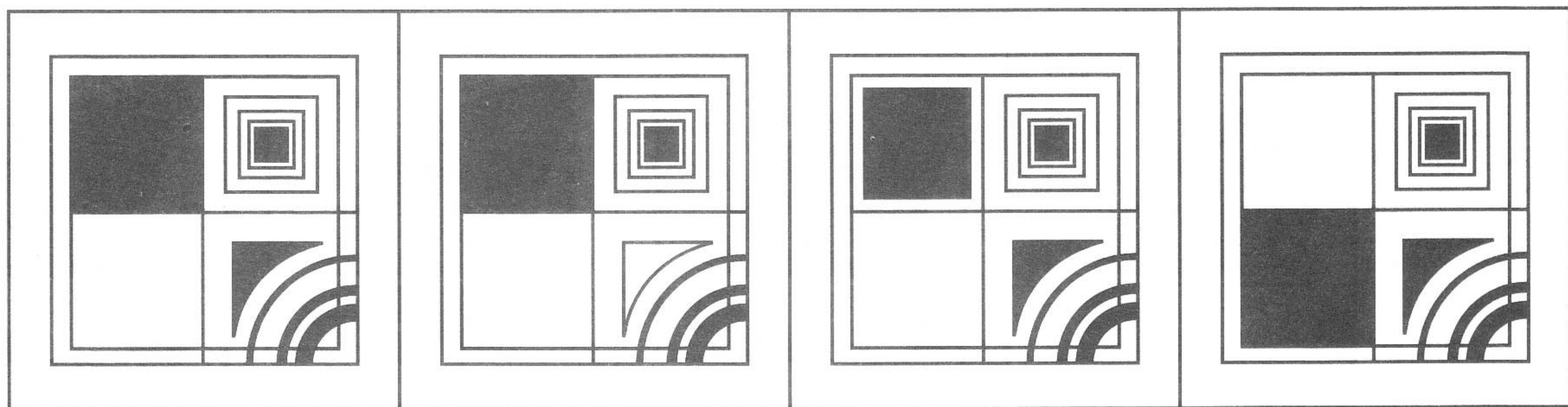
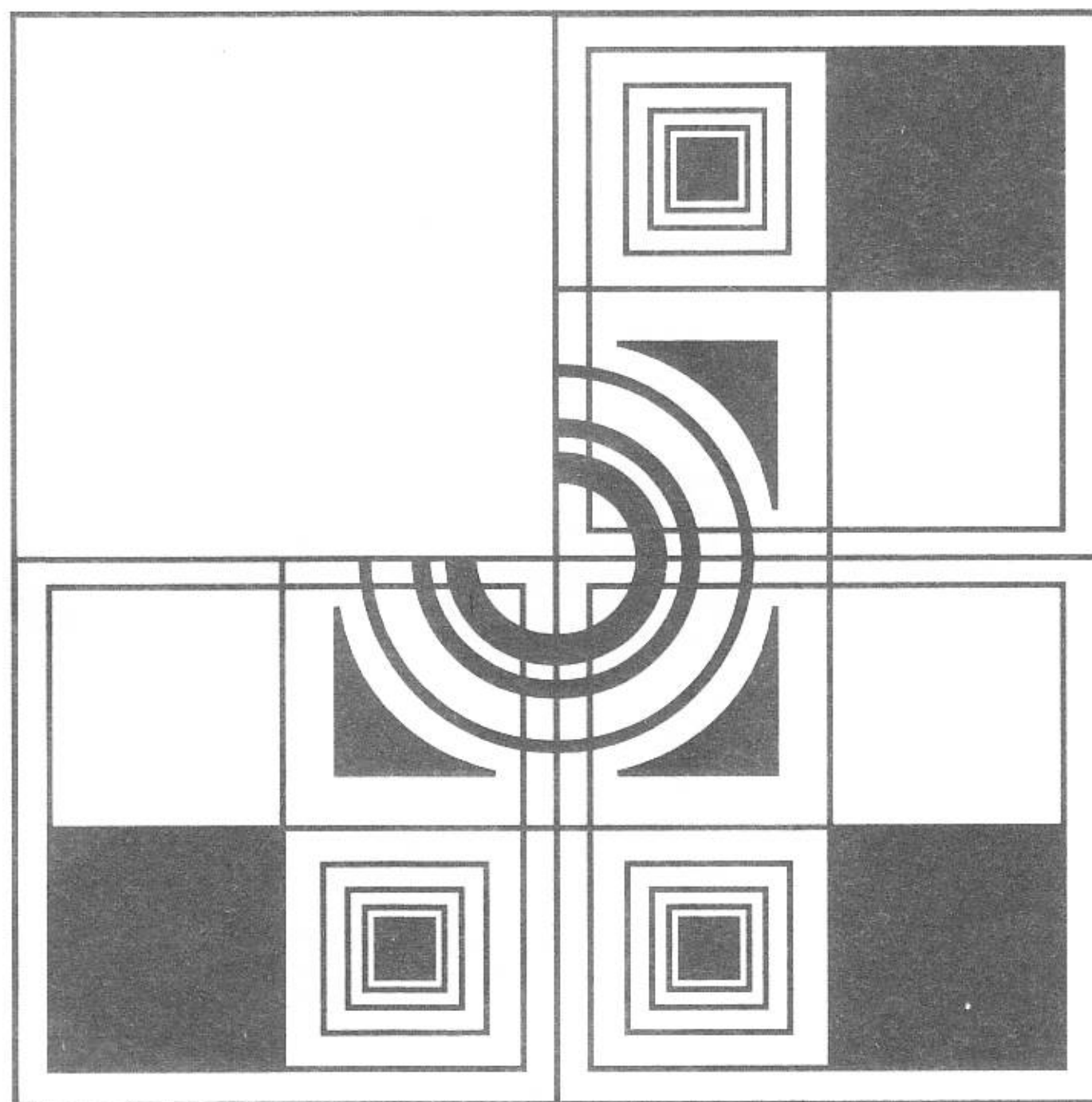

ก

ข

ค

ง

11

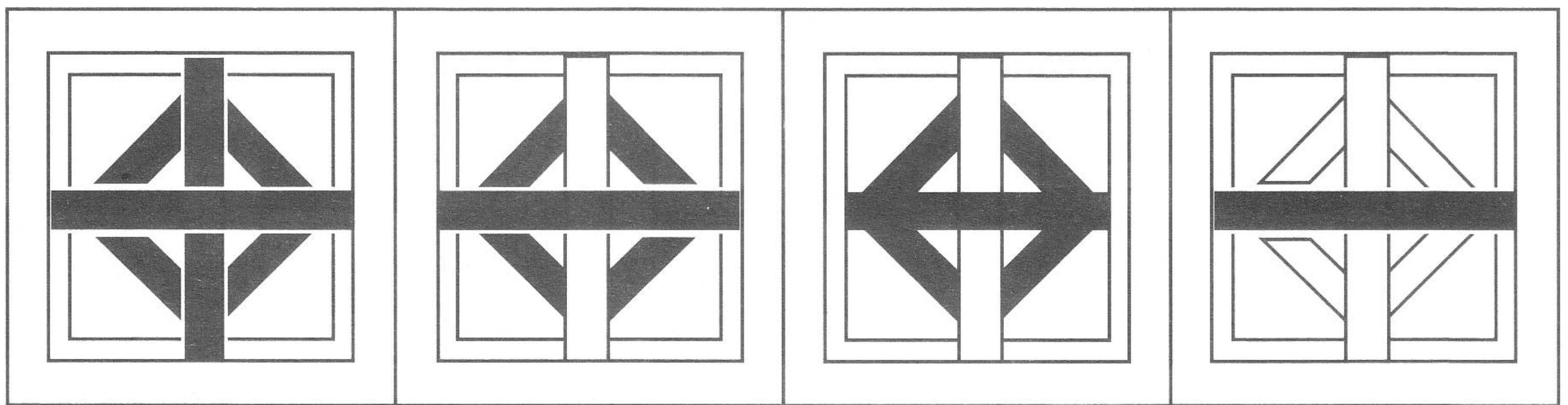
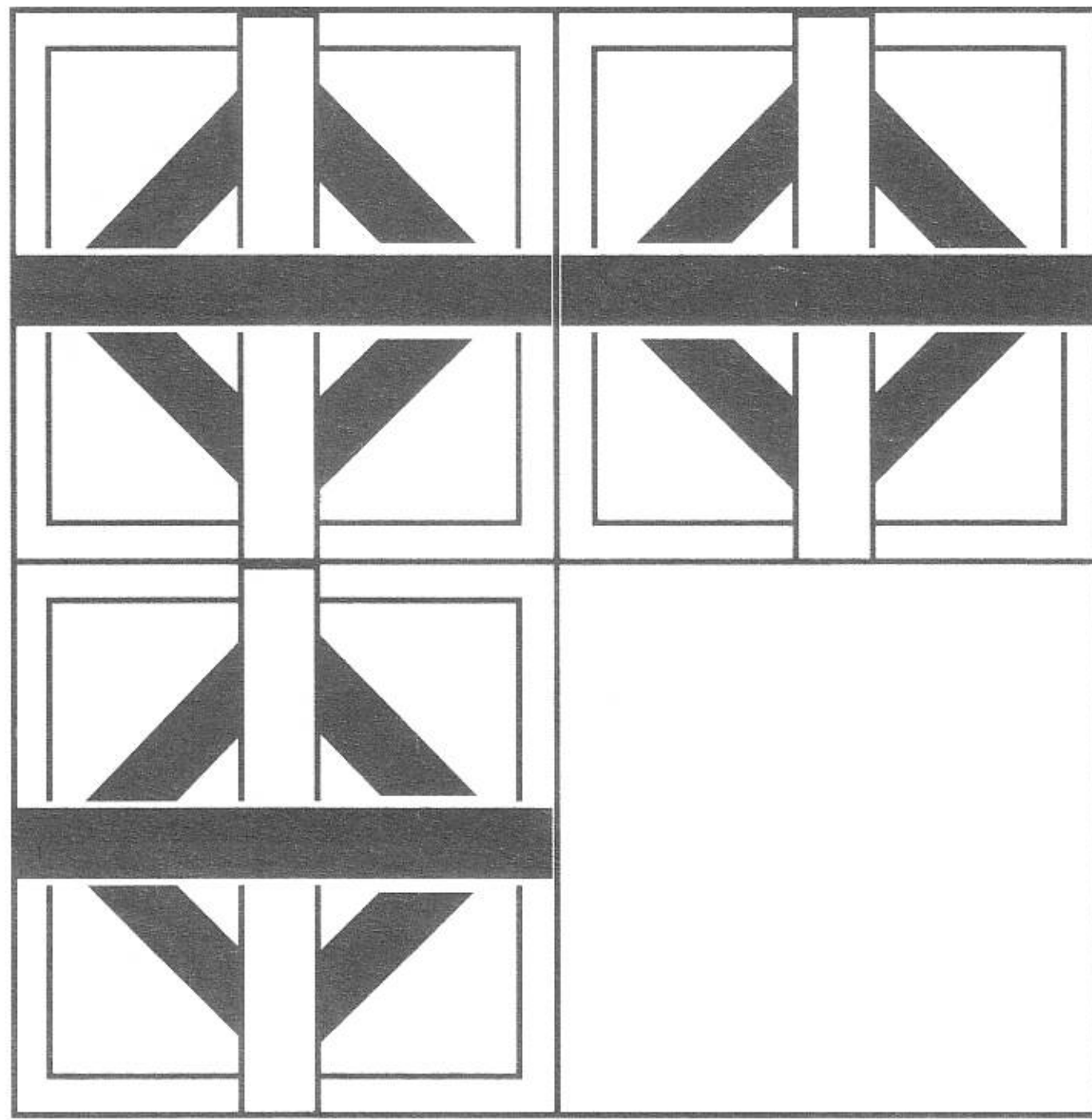

ก

ข

ค

ง

12

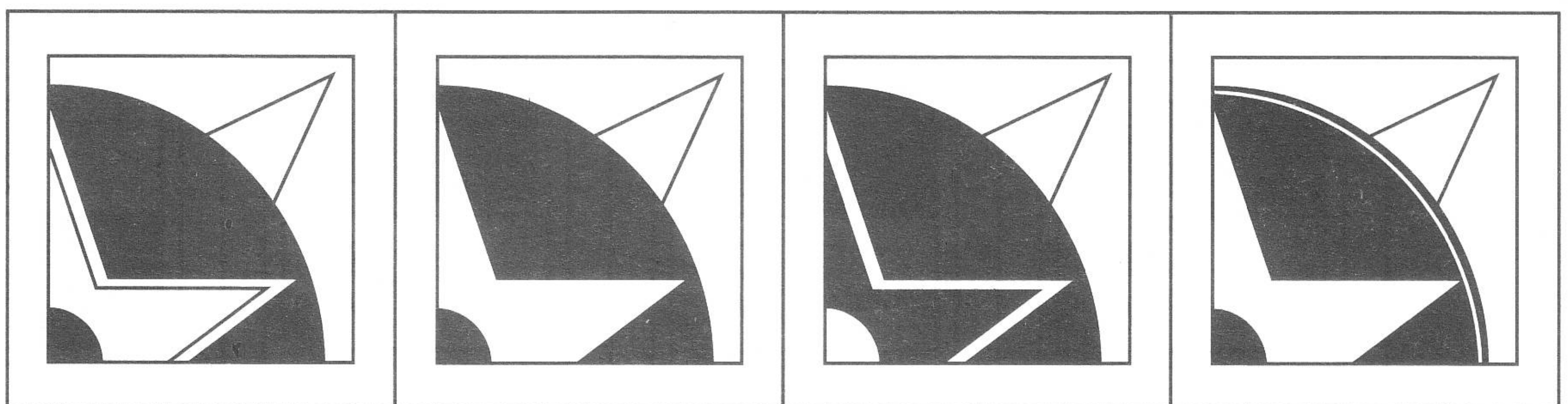
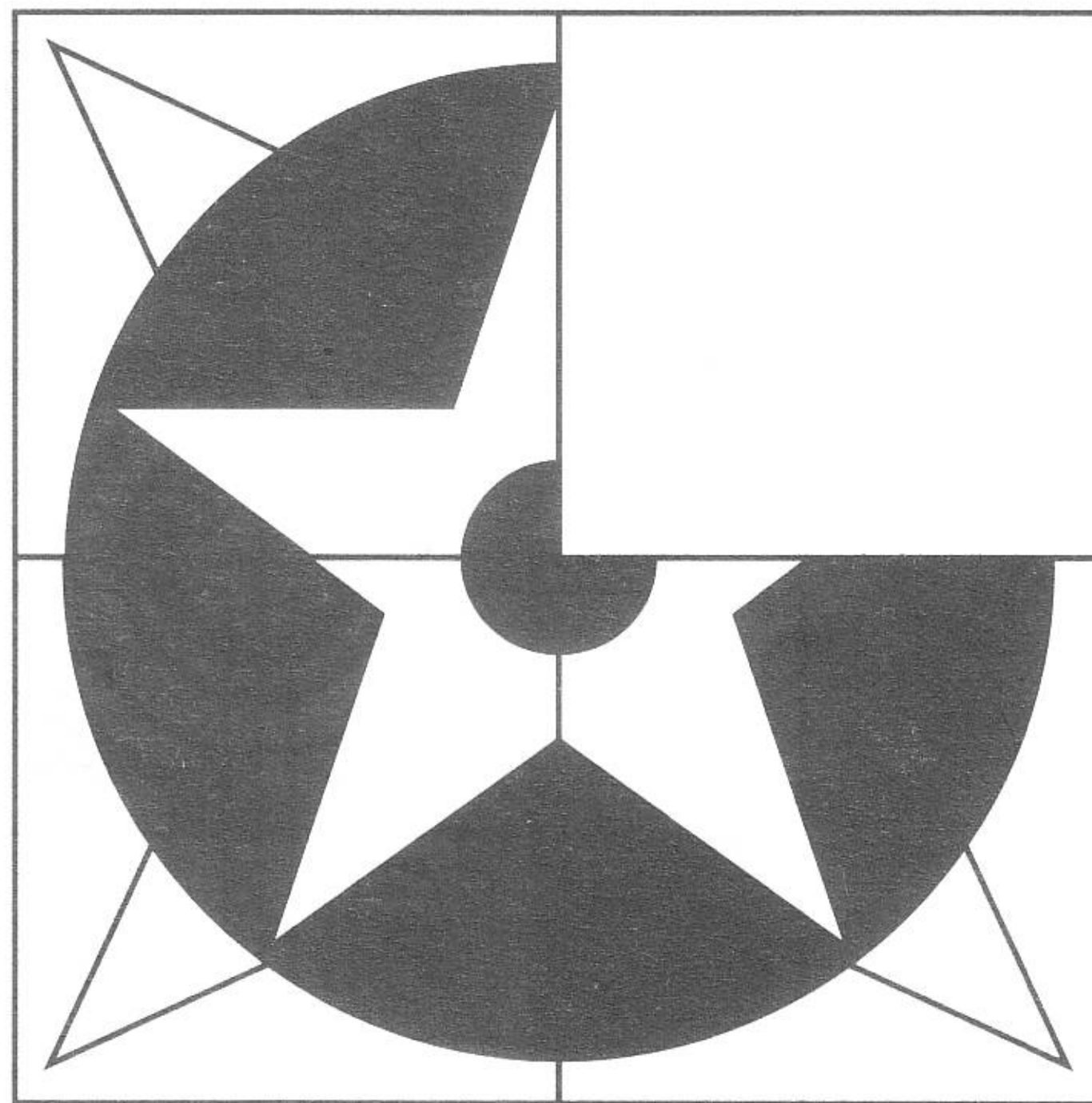

ก

ข

ค

ง

13

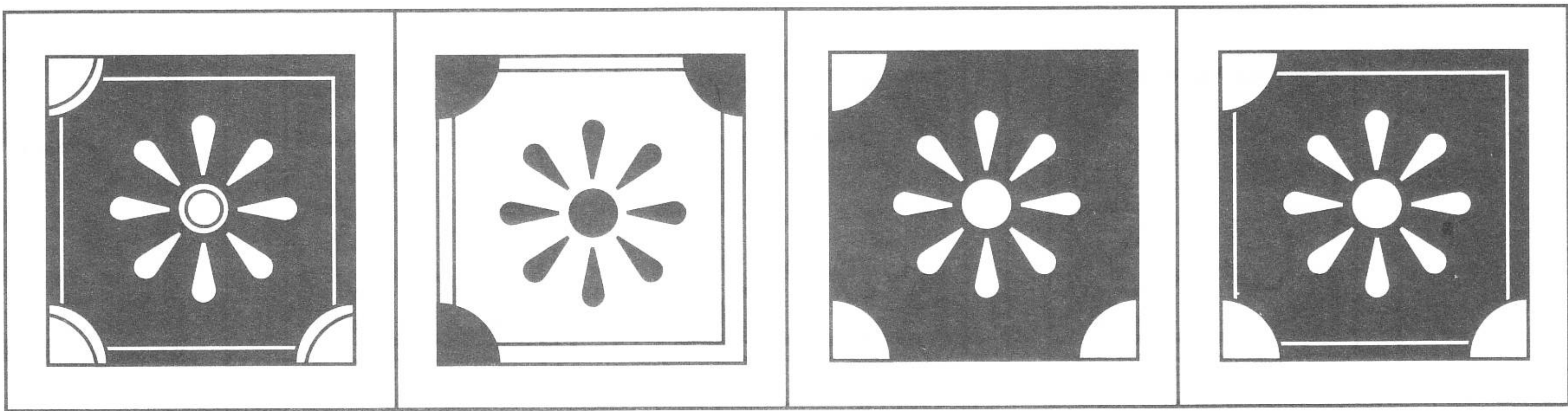
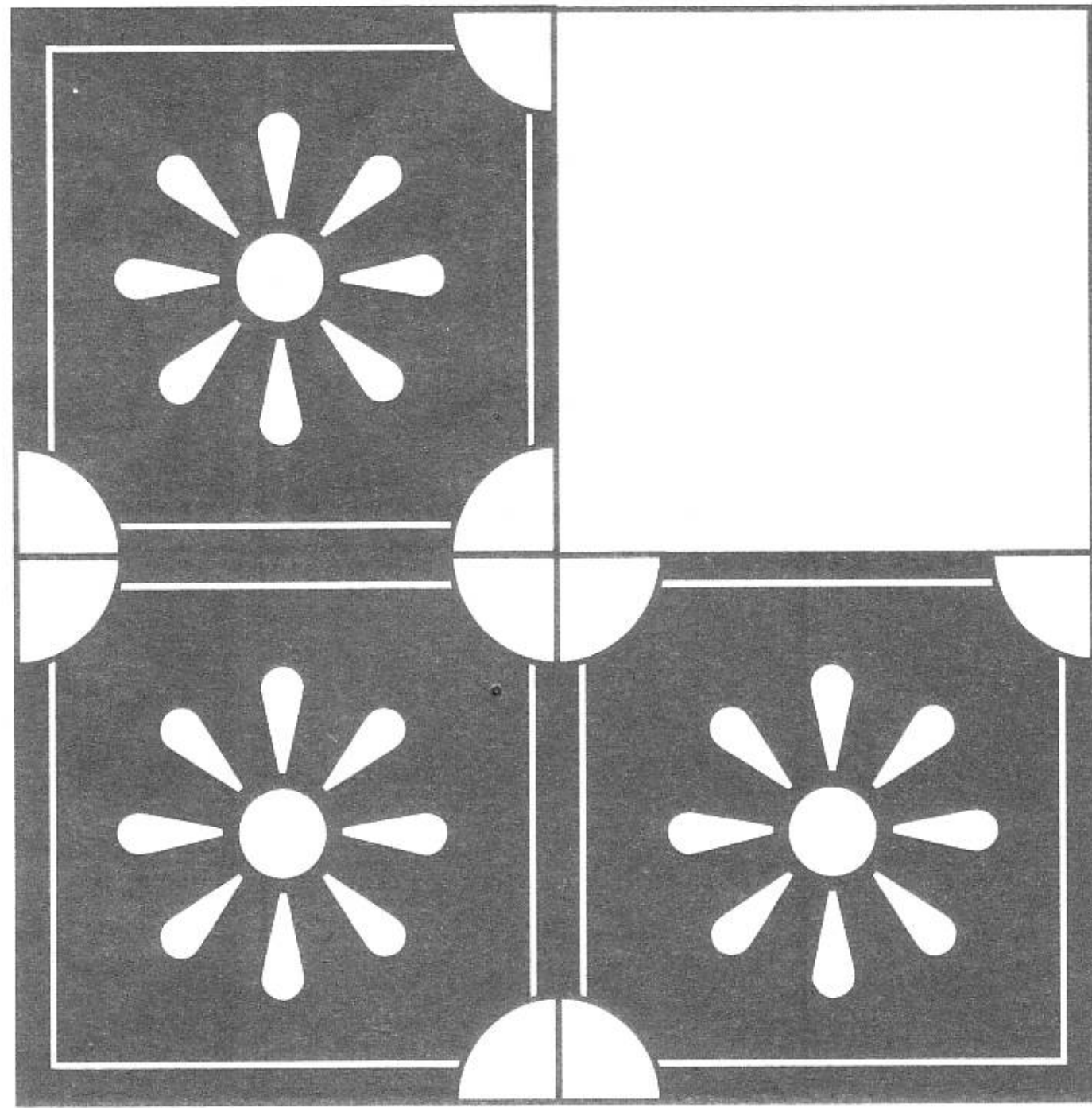

ก

ข

ค

ง

14

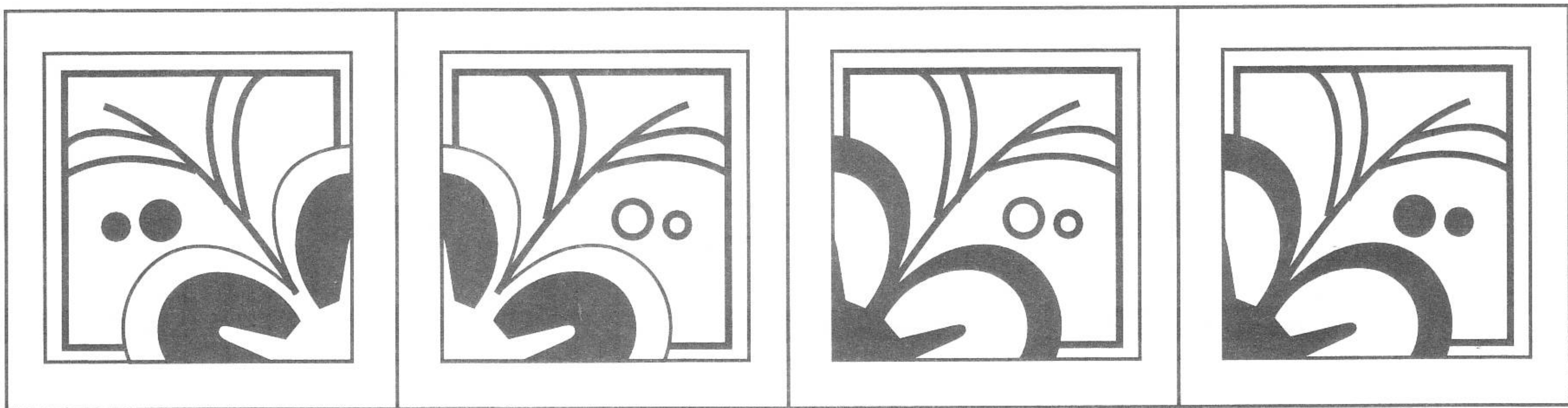
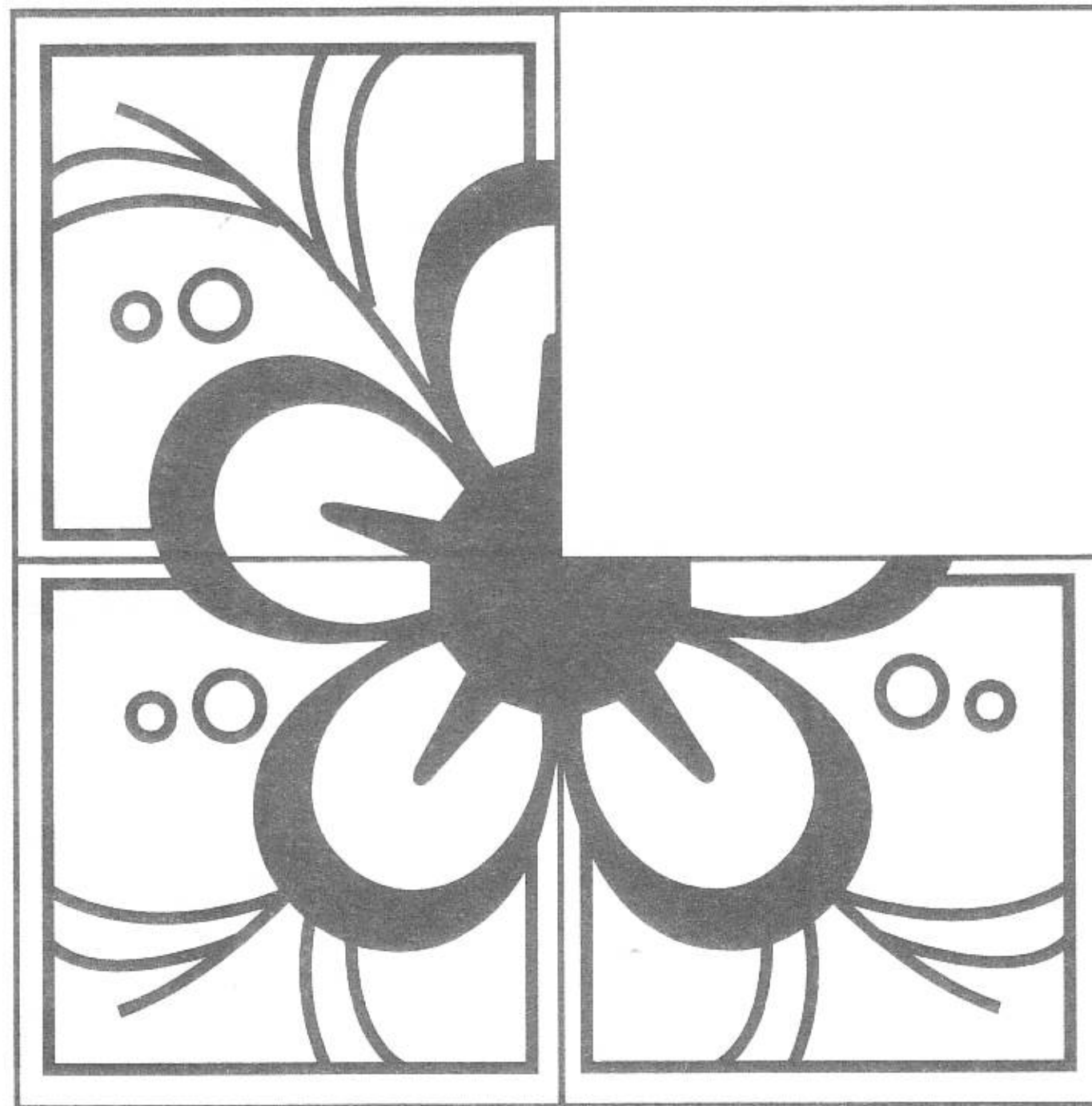

ก

ข

ค

ง

15

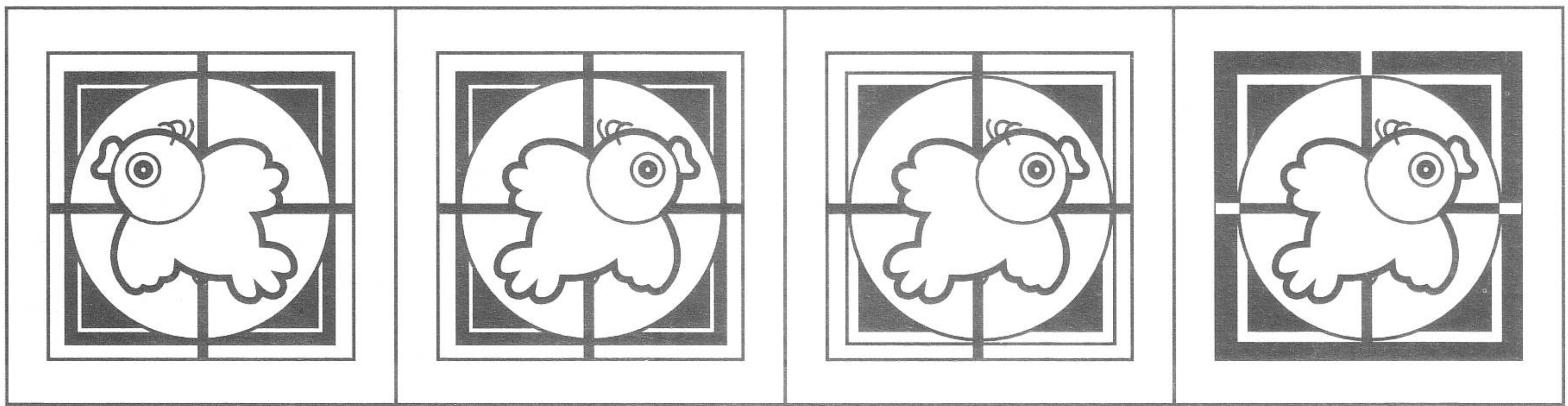
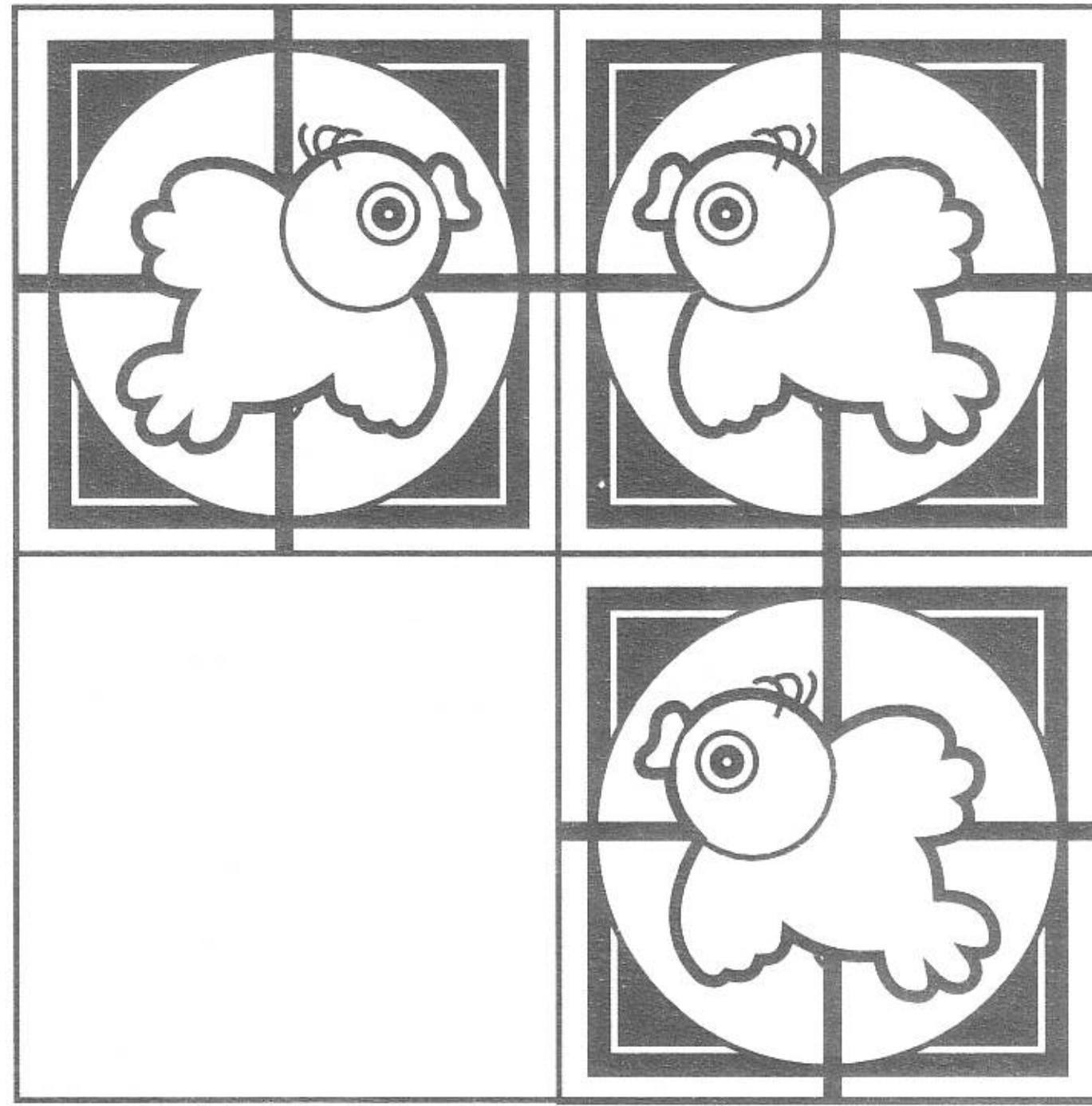

ก

ข

ค

ง

16

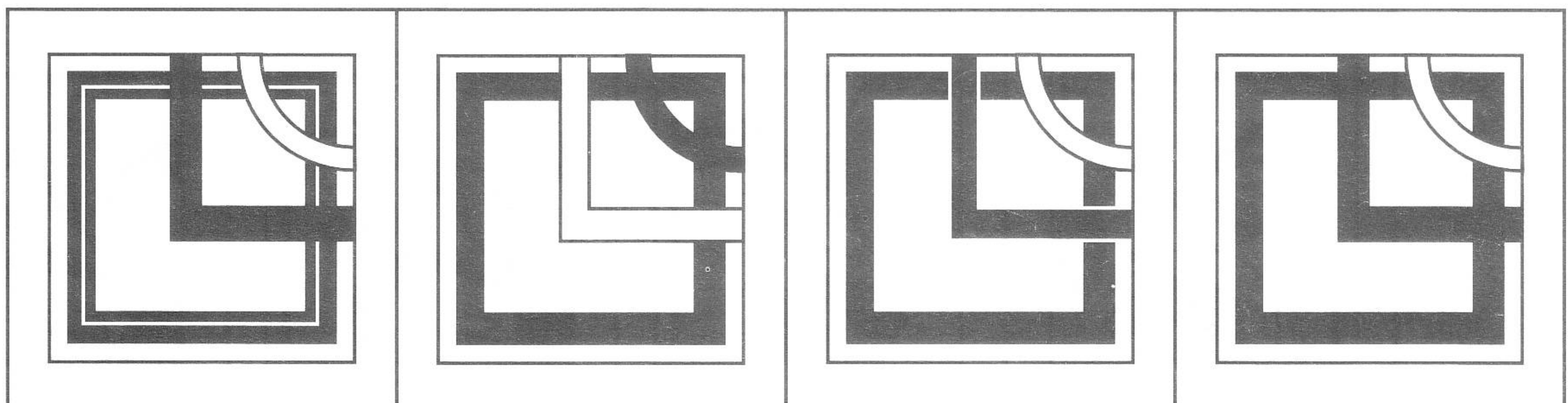
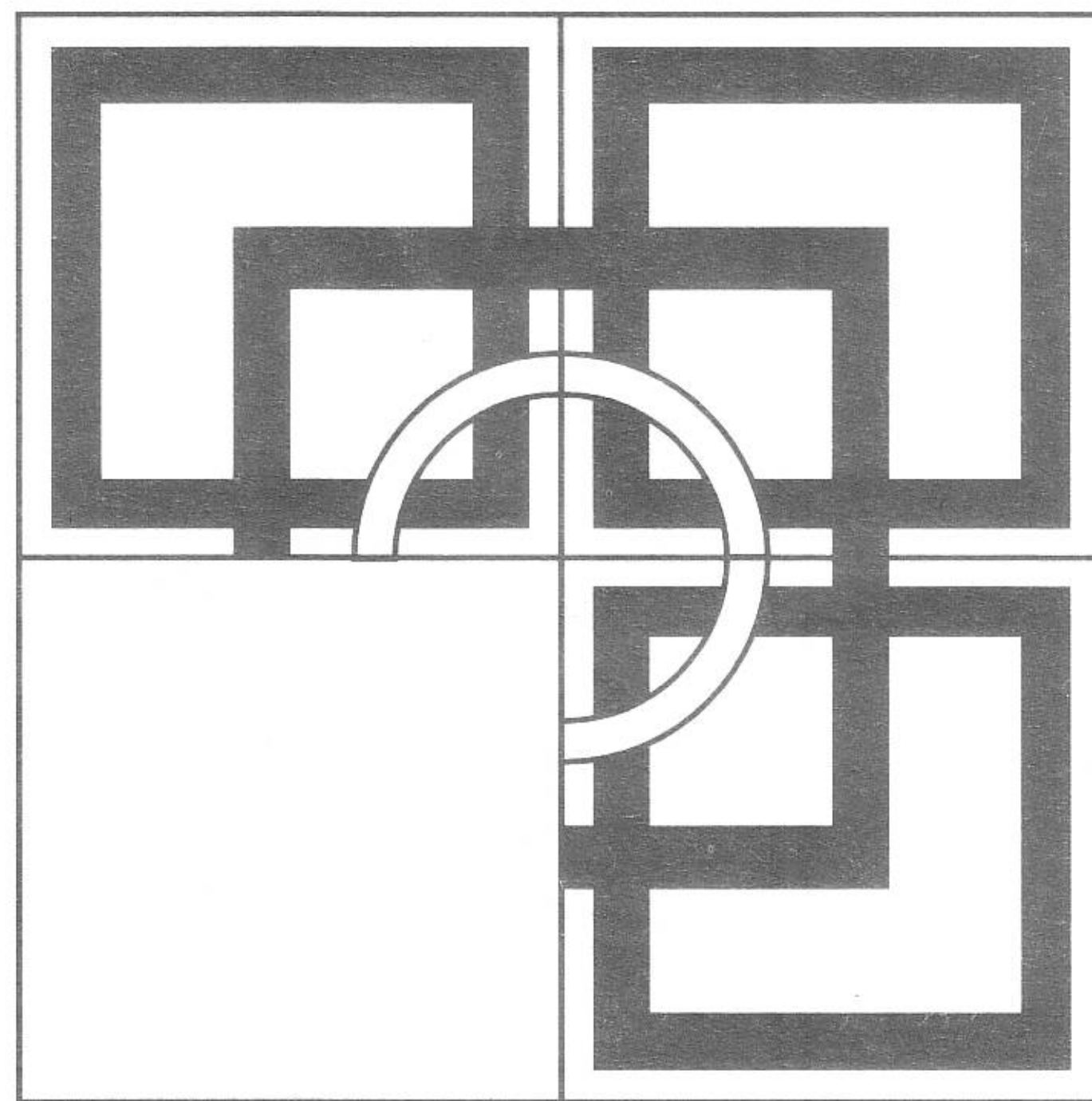

ก

ข

ค

ง

17

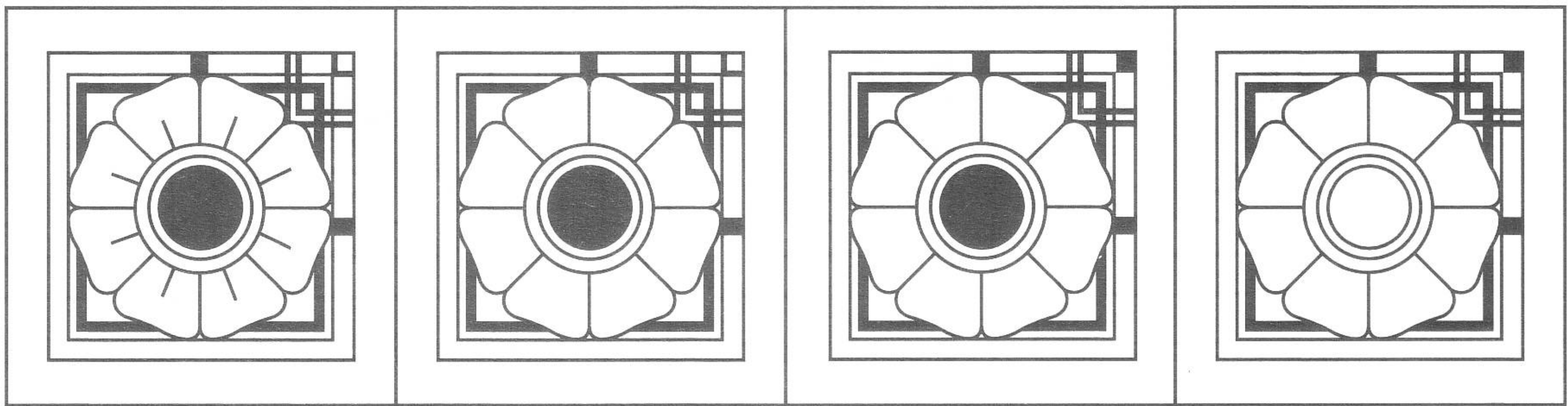
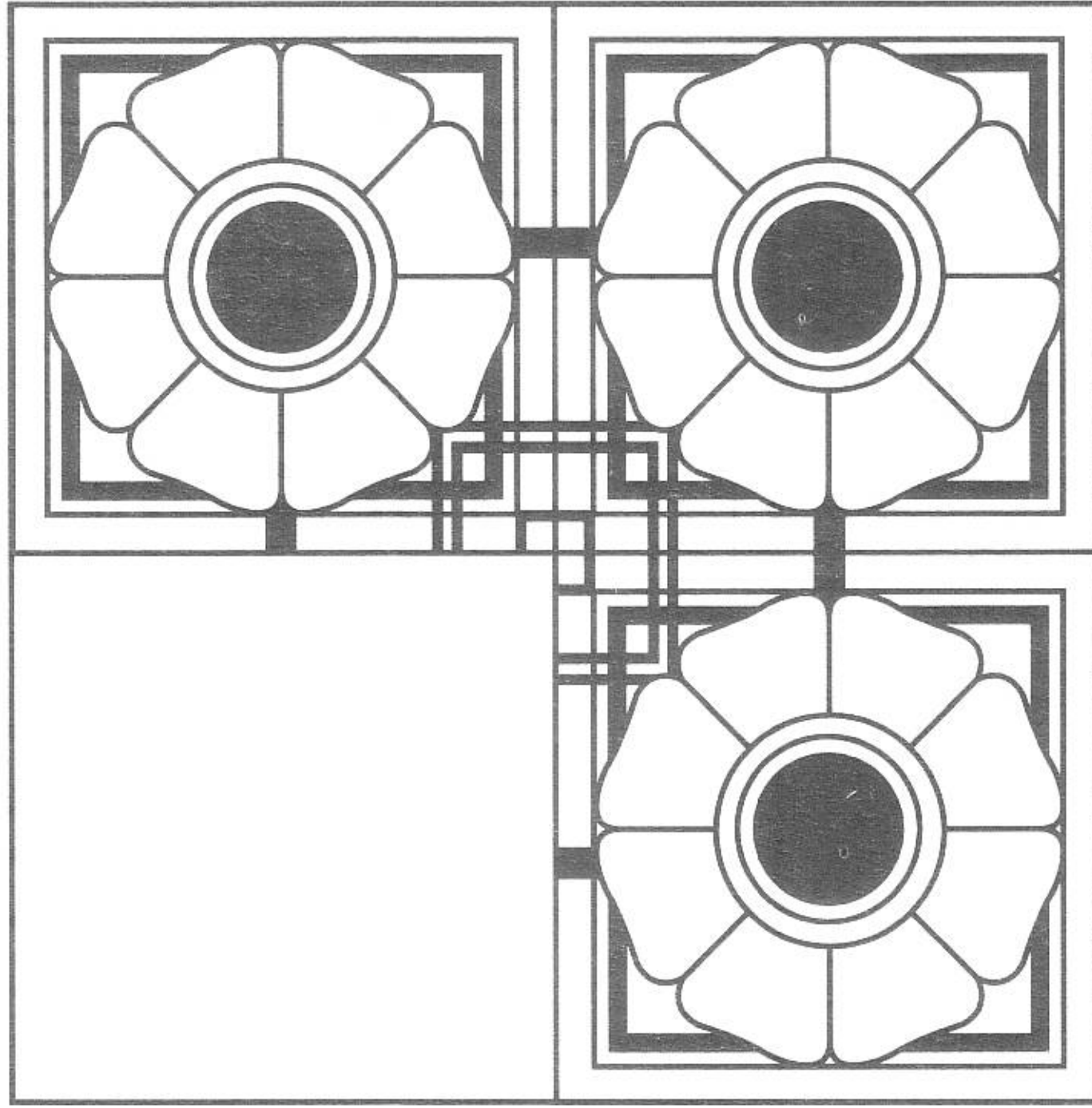

ก

ข

ค

ง

18

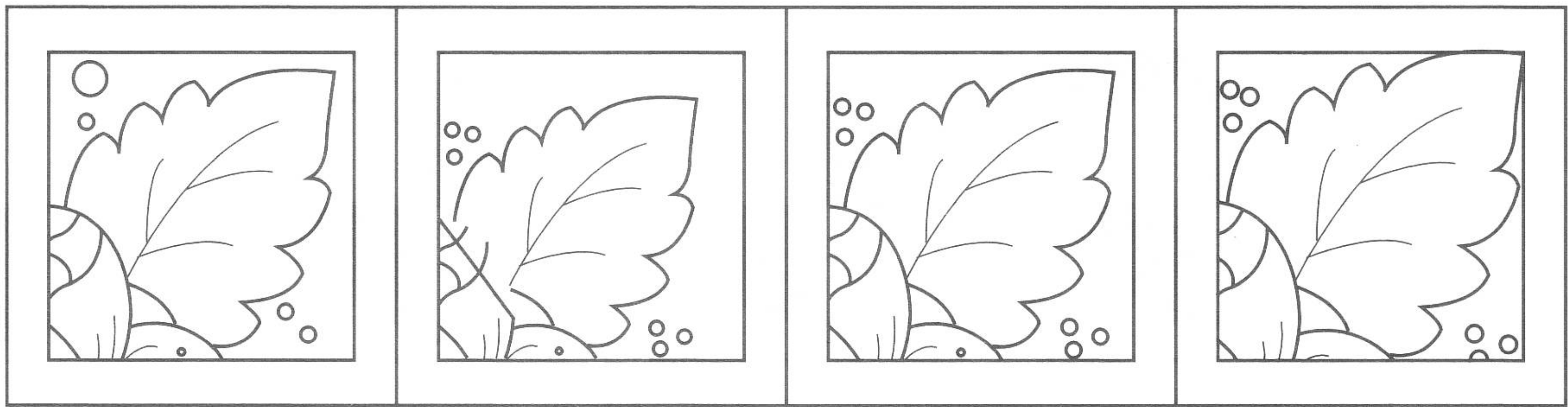
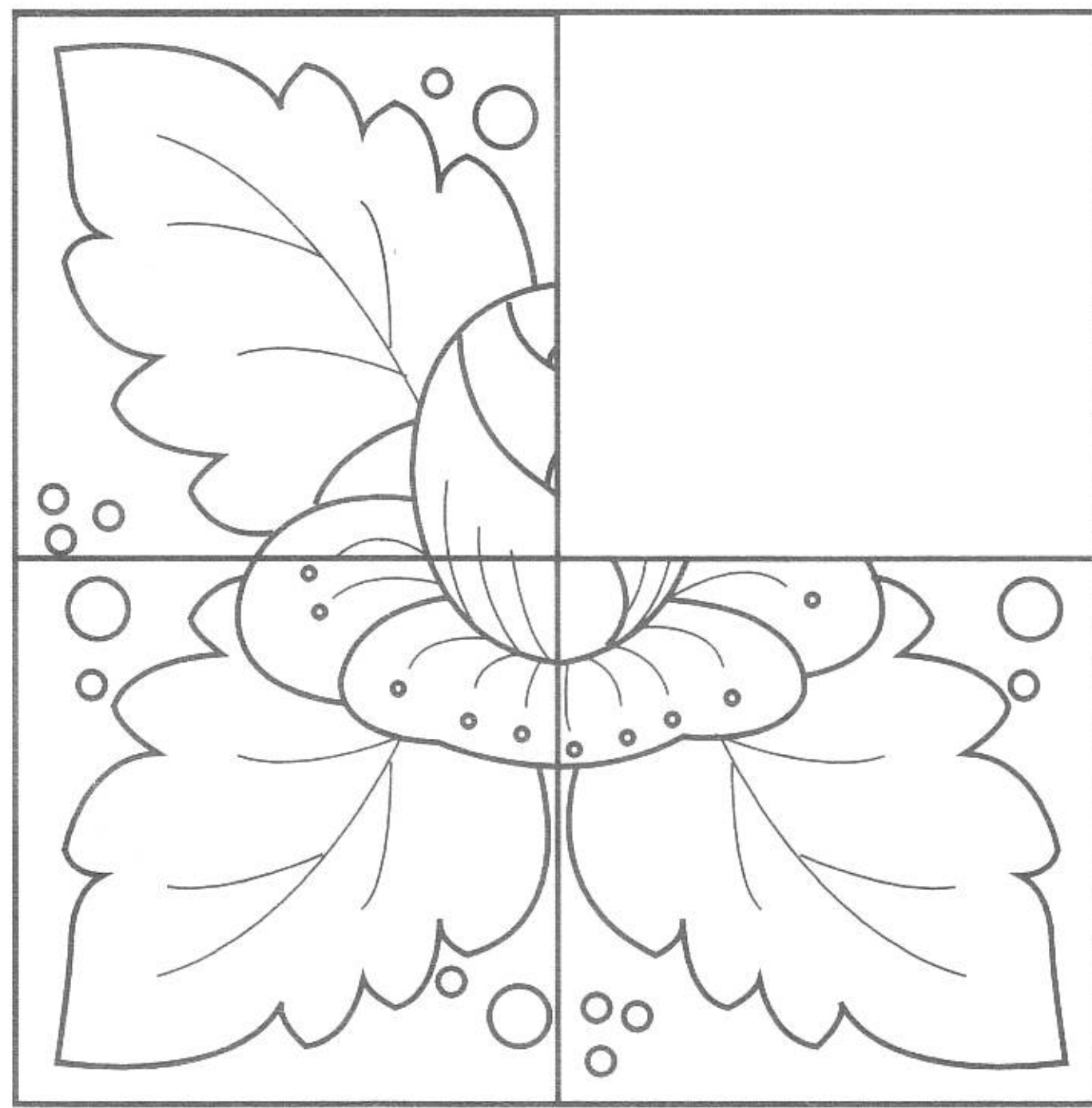

ก

ข

ค

ง

19

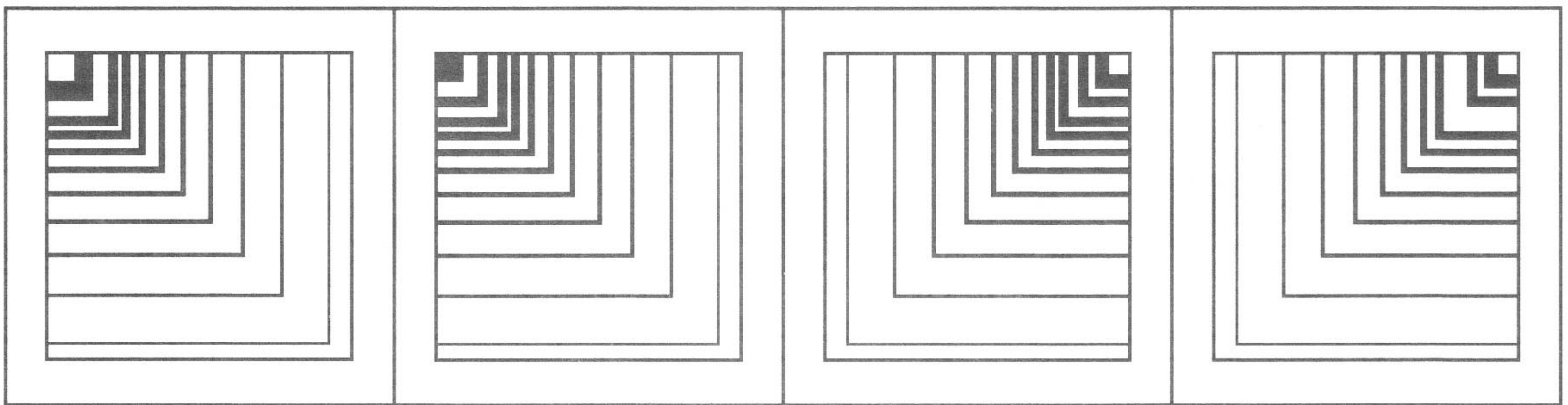
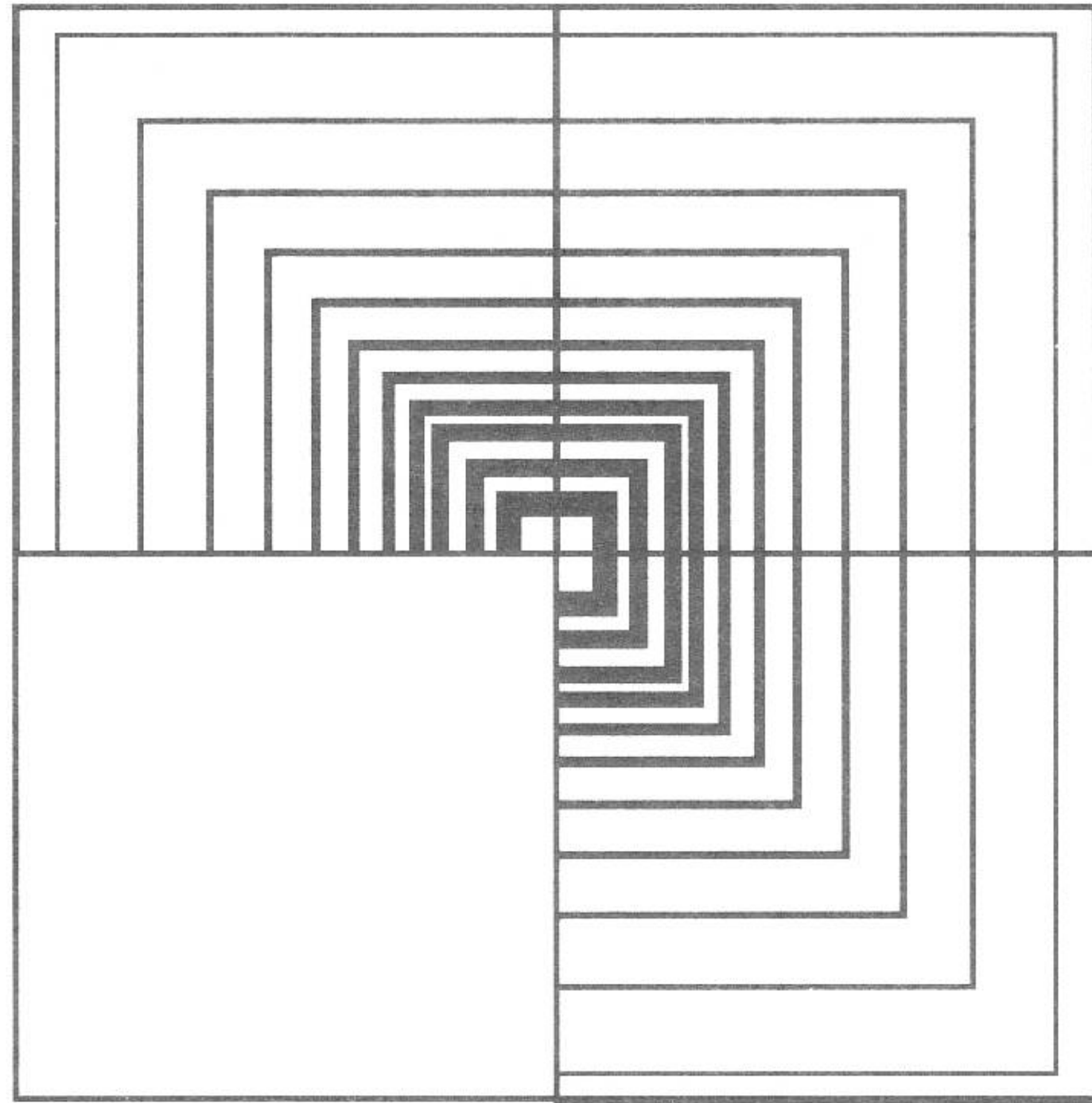

၁

၂

၃

၄

20

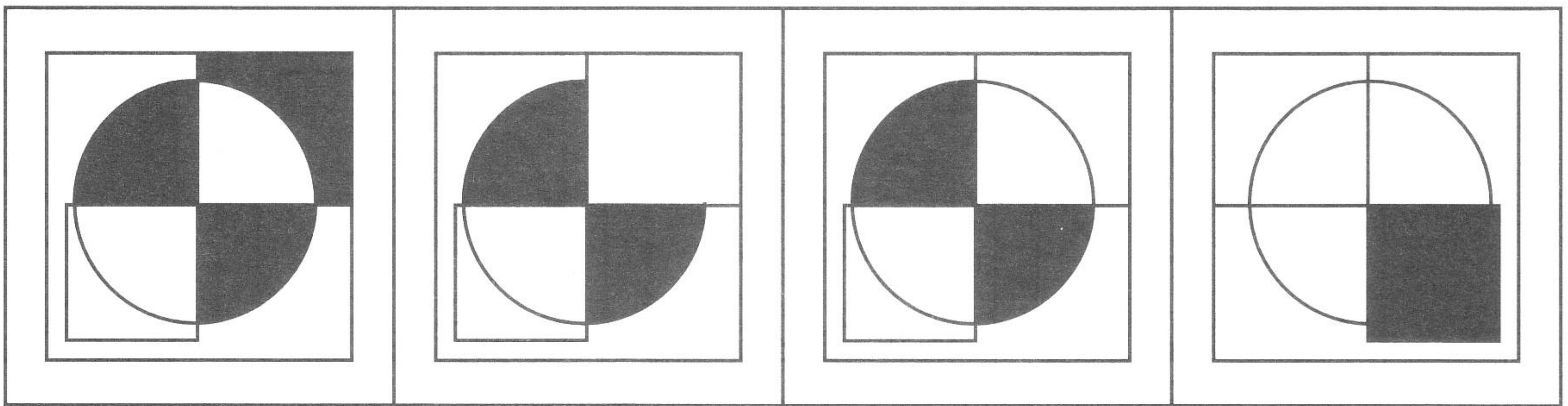
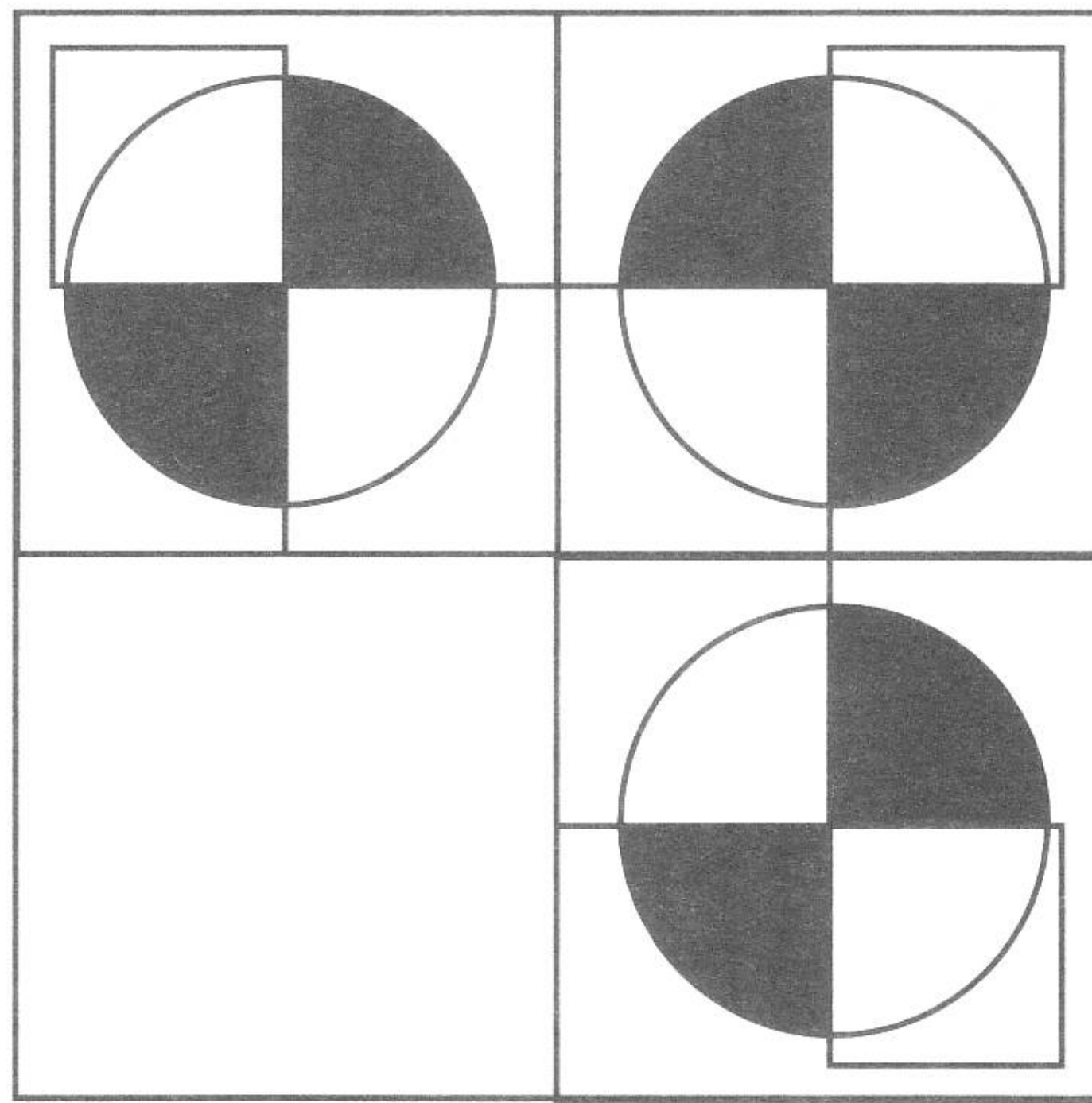

၁

၂

၃



၄

จงขีด ✕ ภาพที่ซ่อนอยู่ในภาพแรก

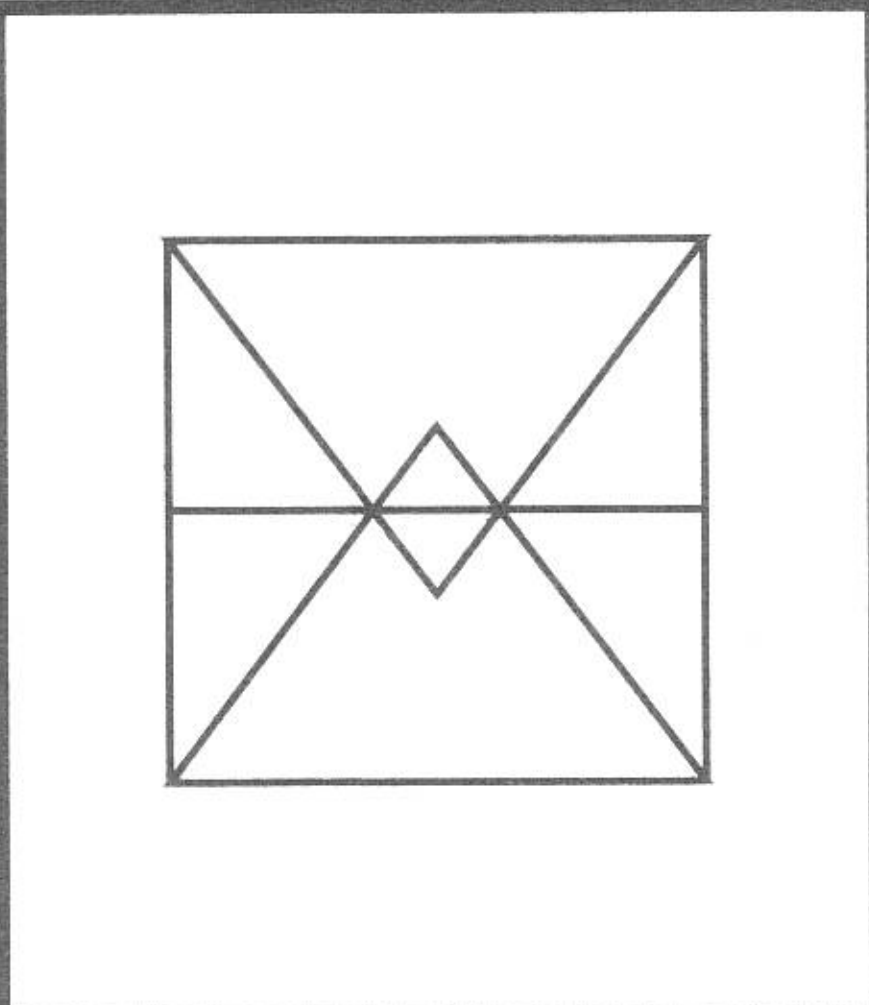
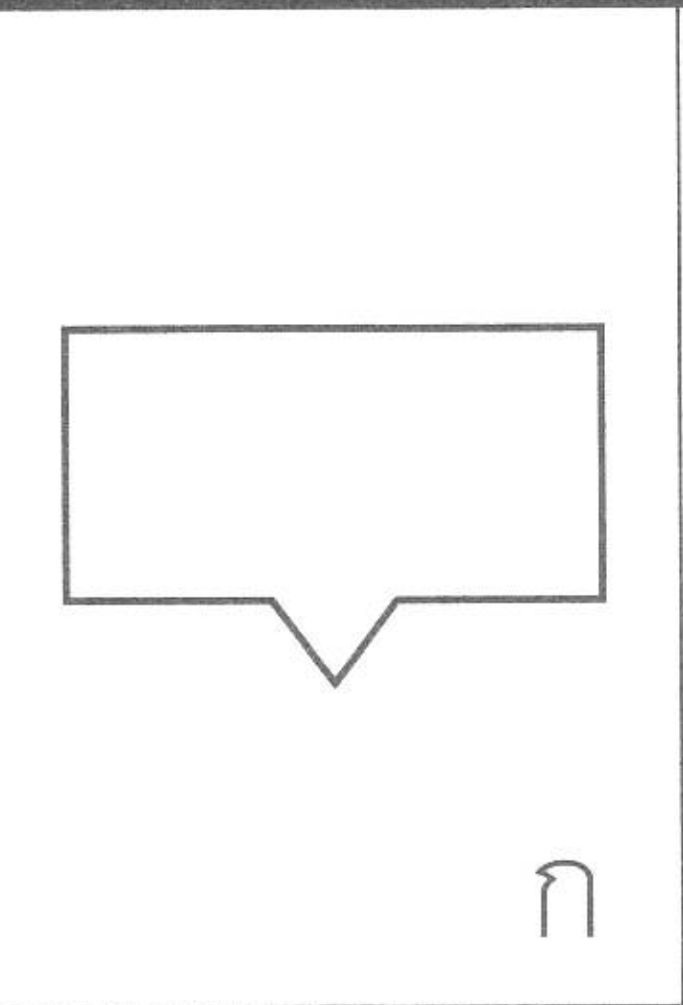
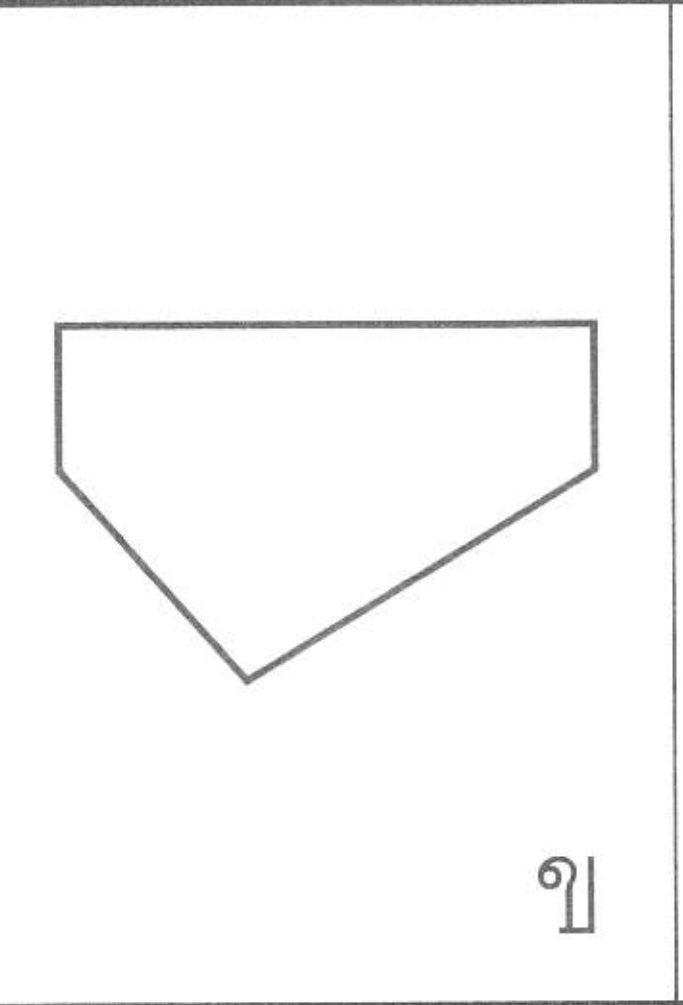
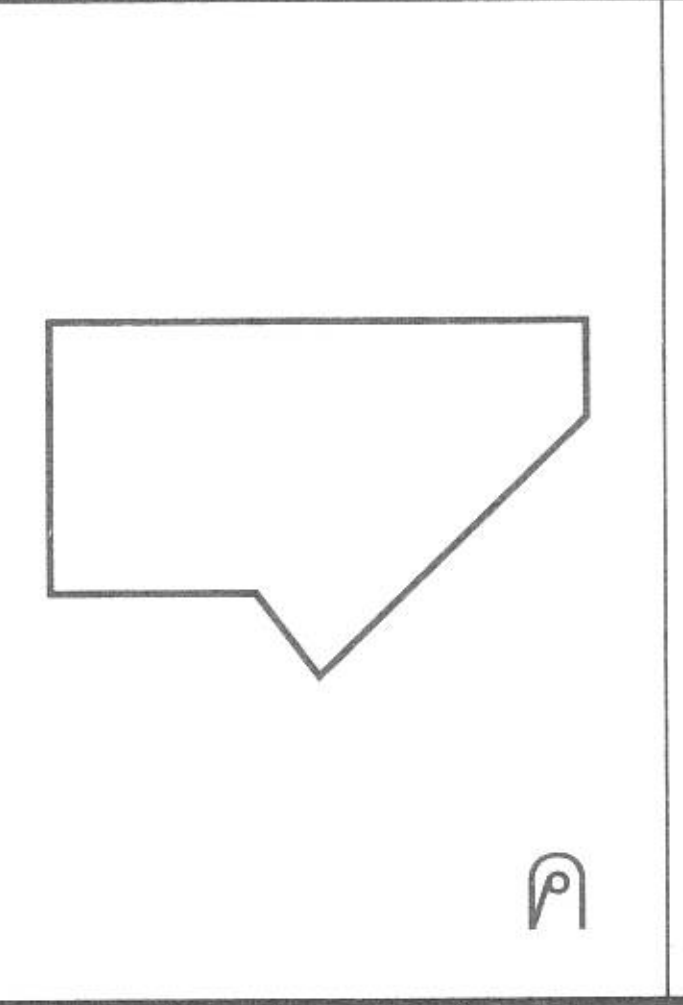
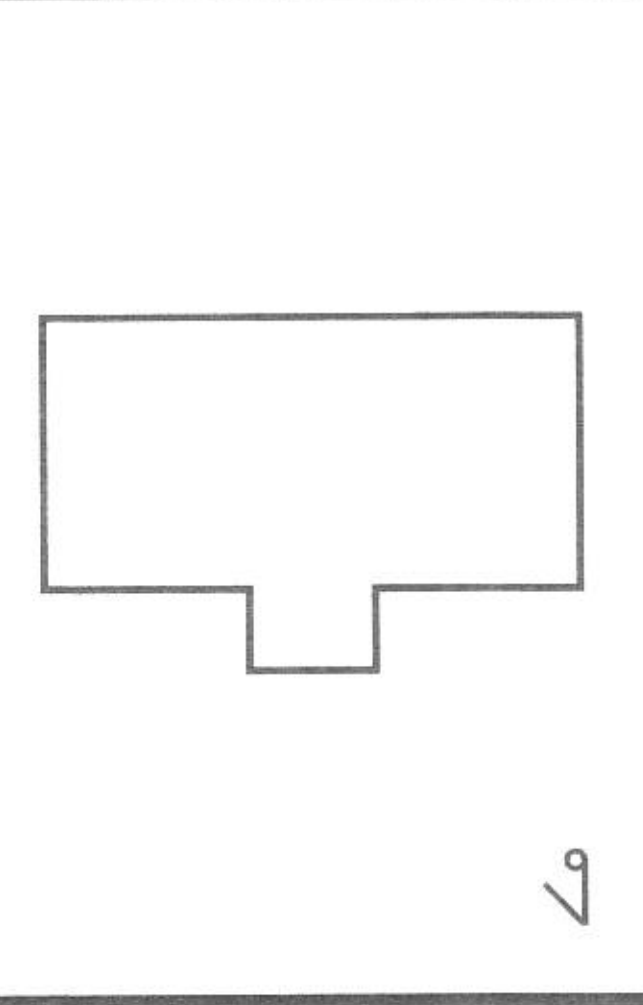
1

	 ก	 ข	 ค	 ง
---	--	---	--	--

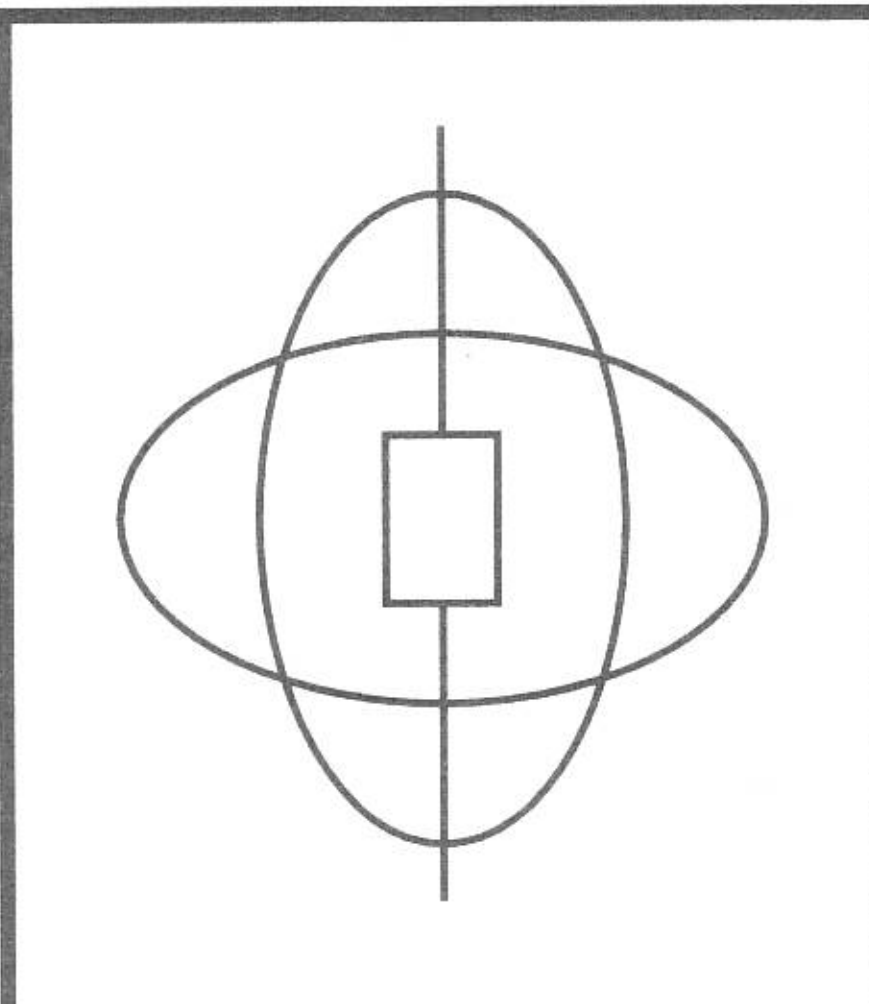
2

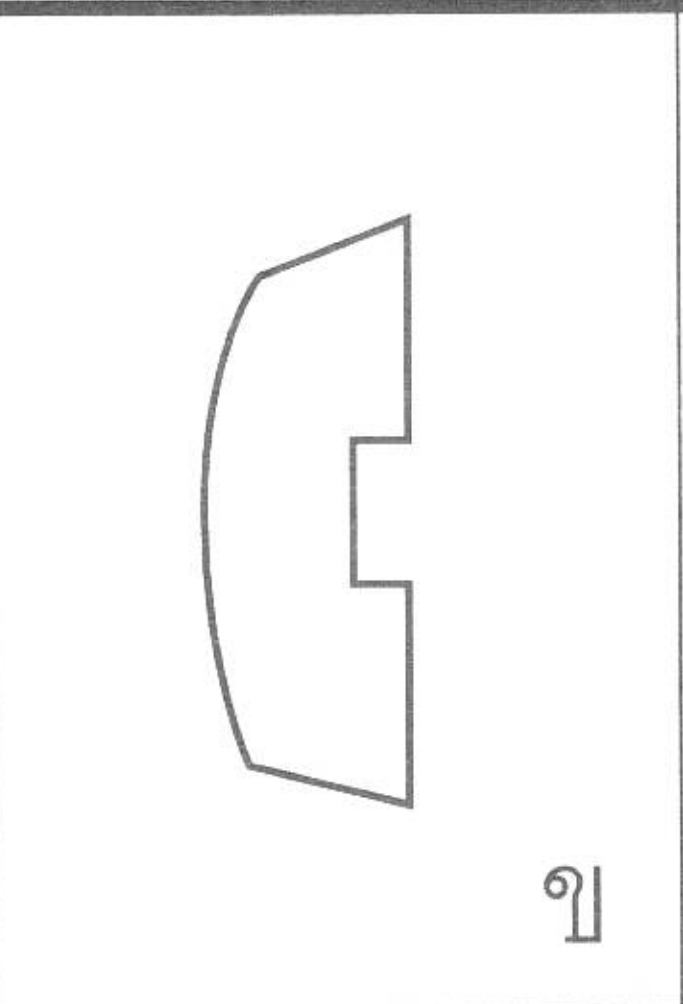
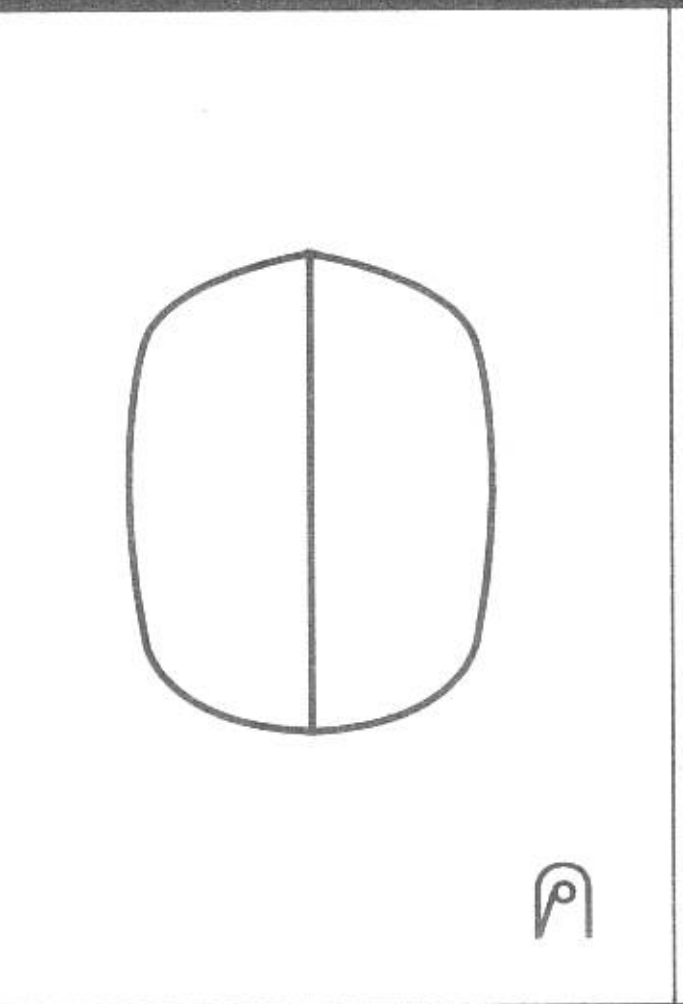
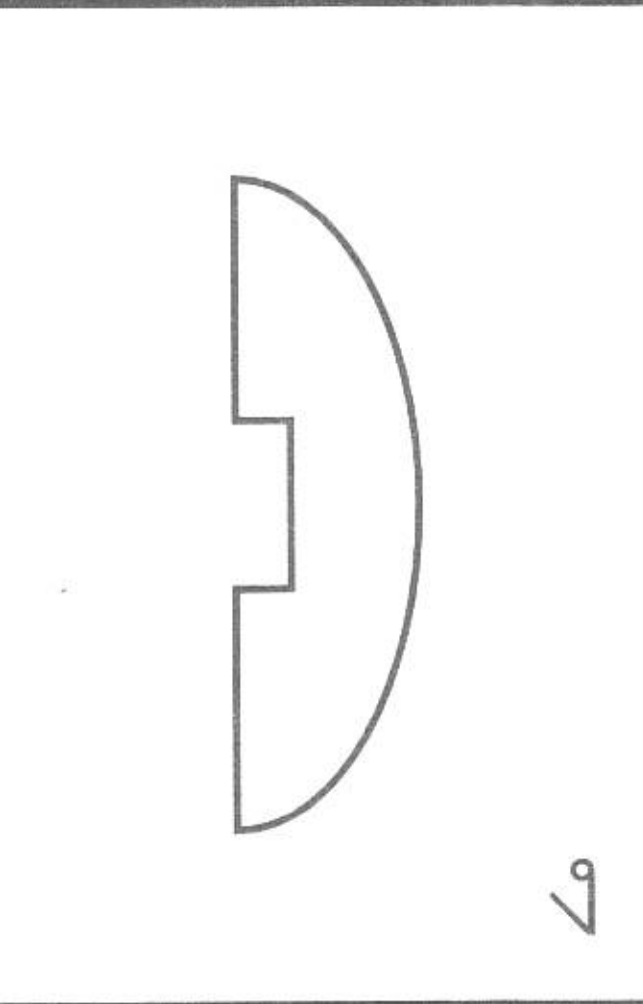
	 ก	 ข	 ค	 ง
--	---	--	---	---

3

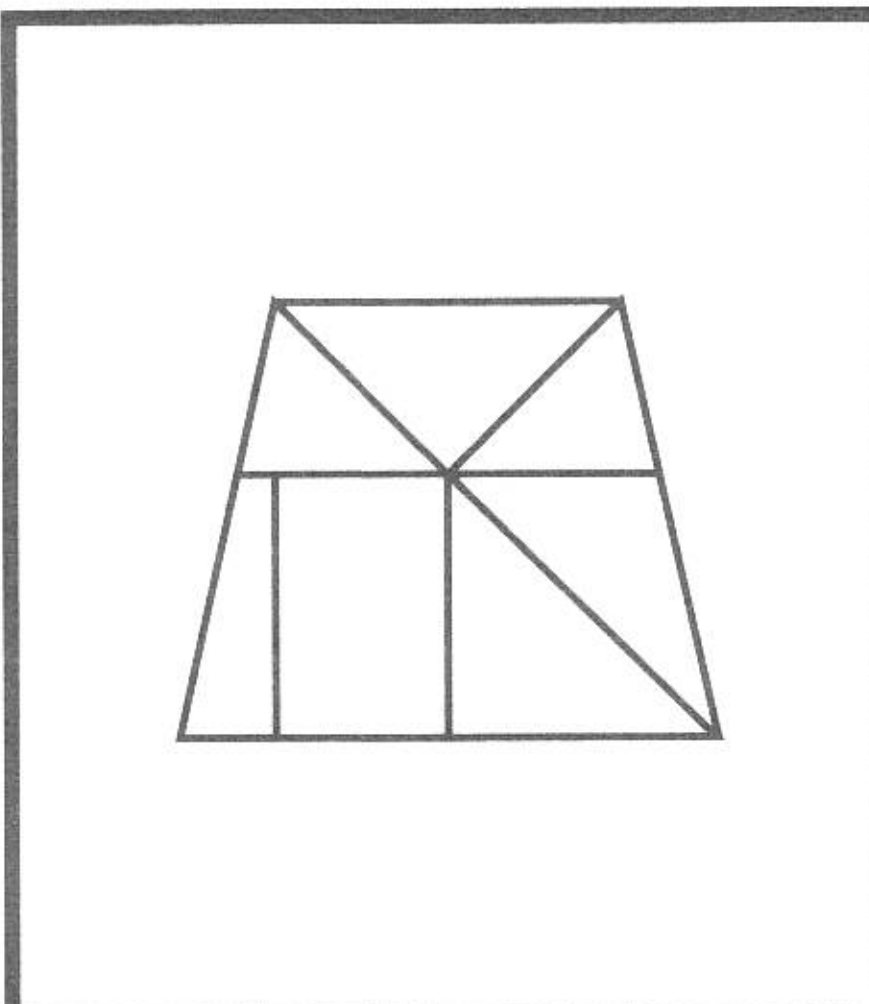
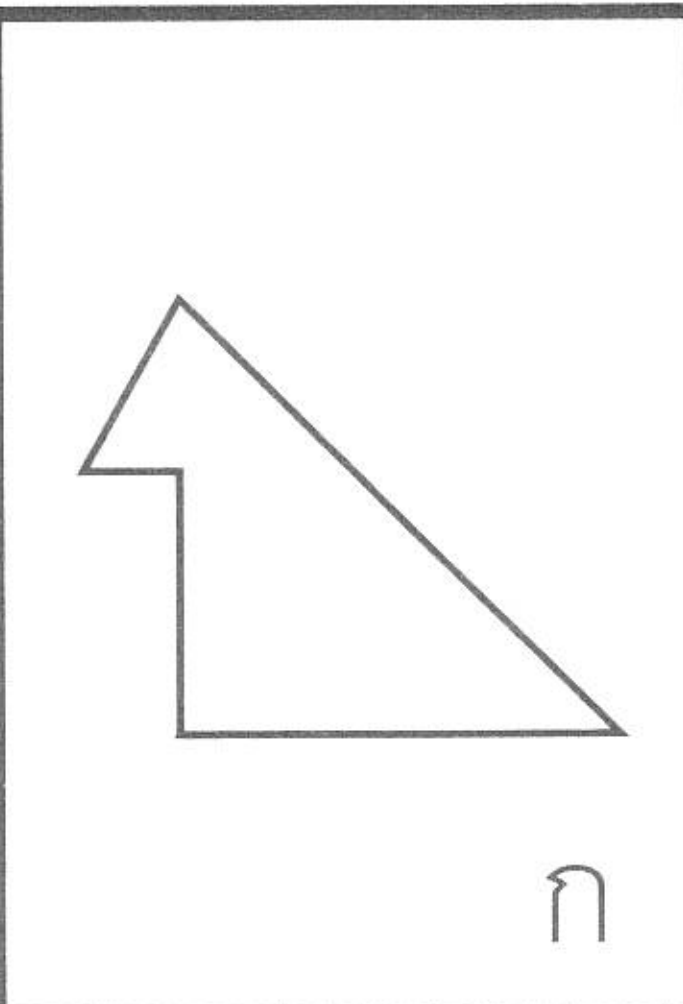
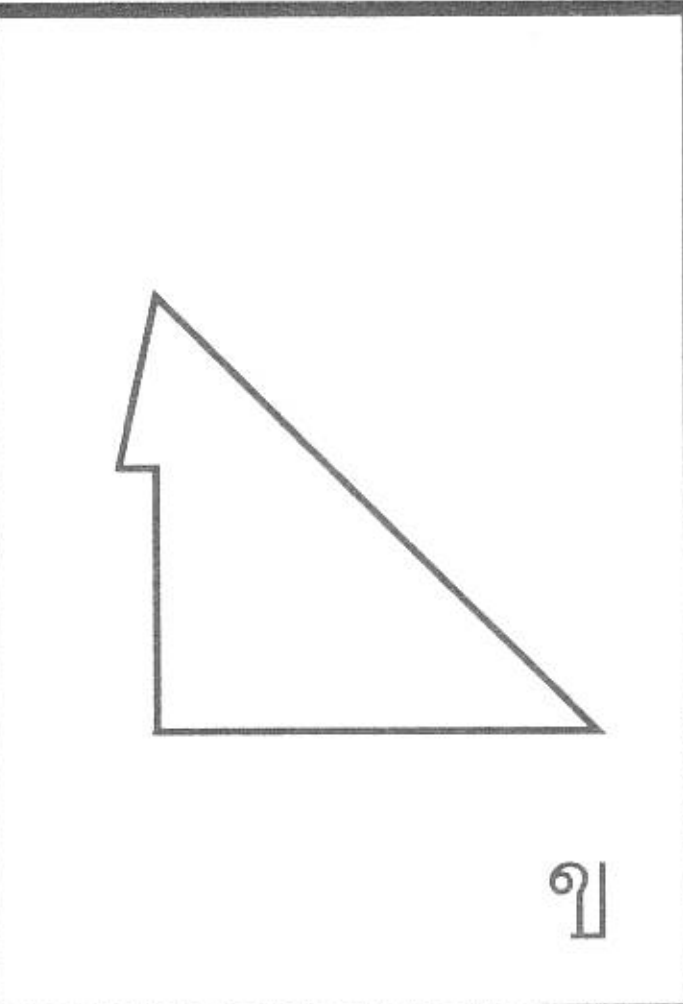
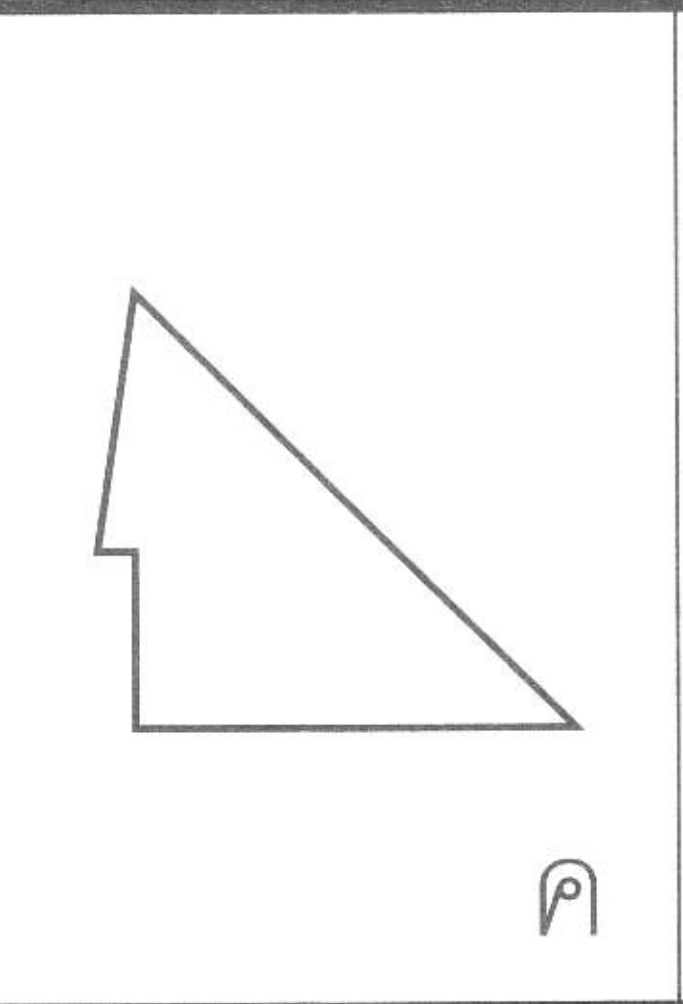
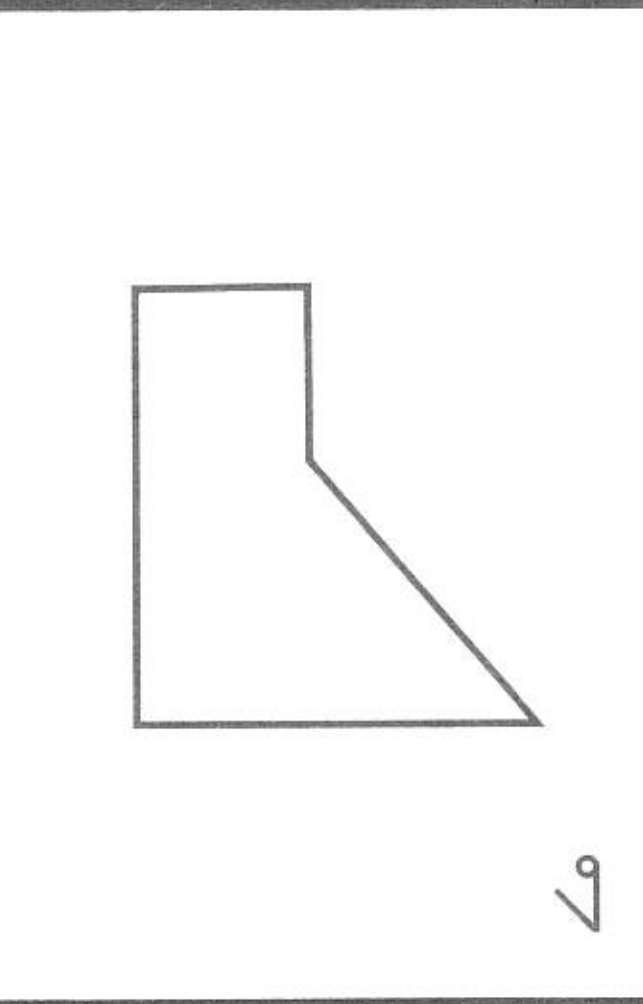
	 ก	 ข	 ค	 ง
---	--	---	--	--

4

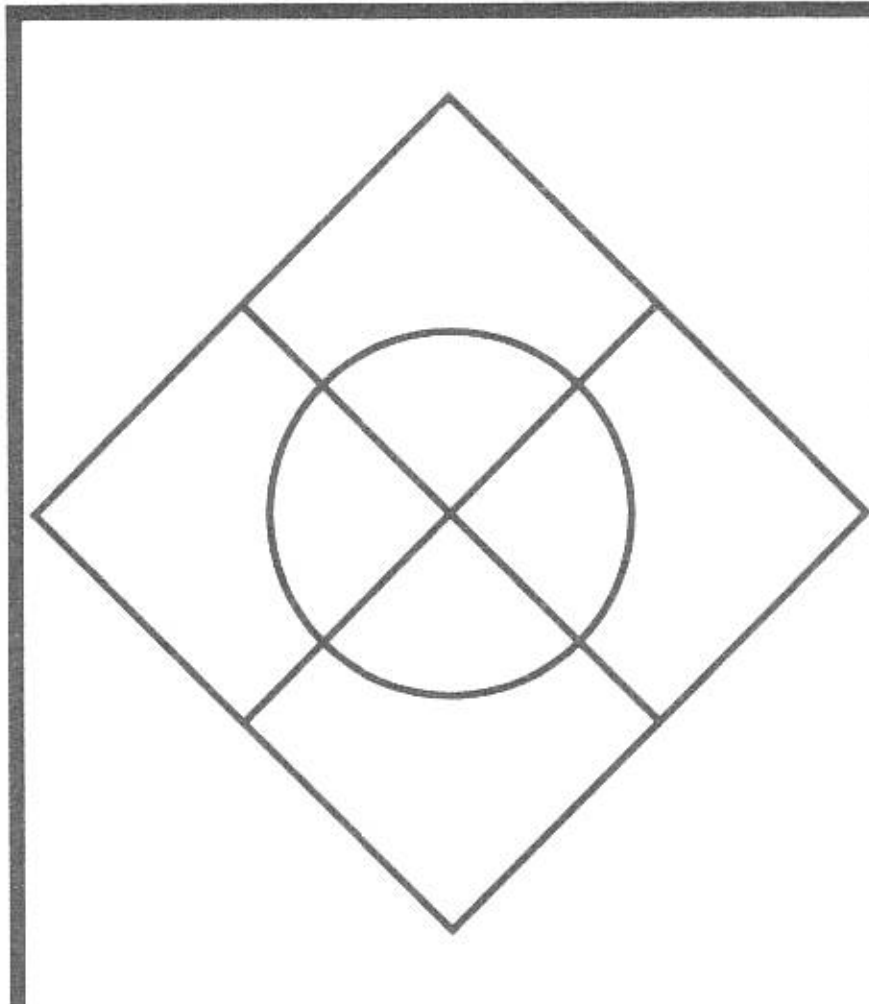
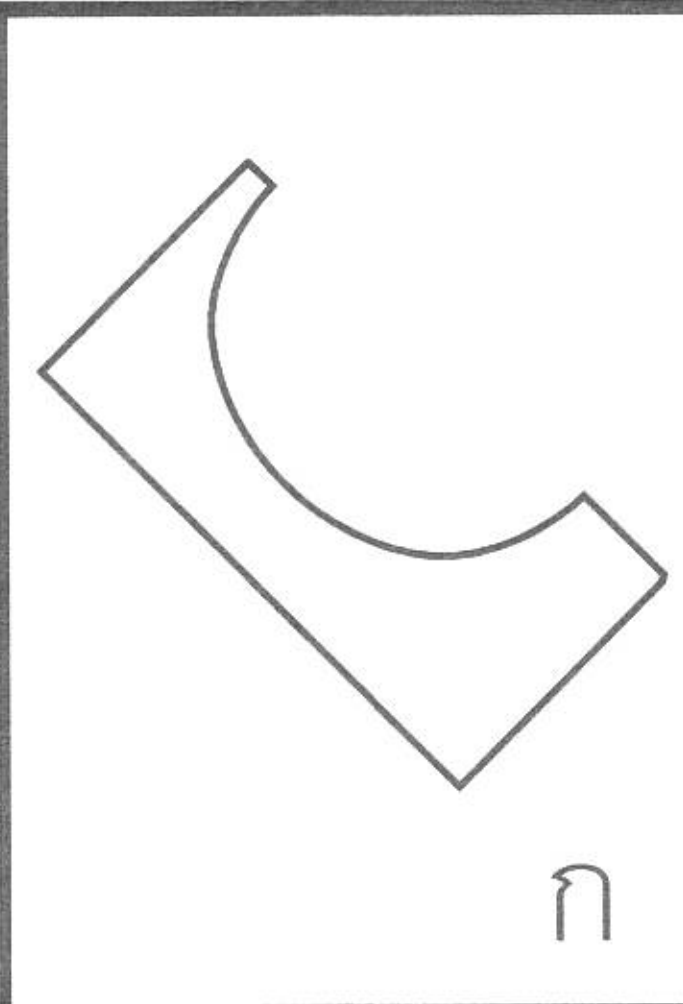
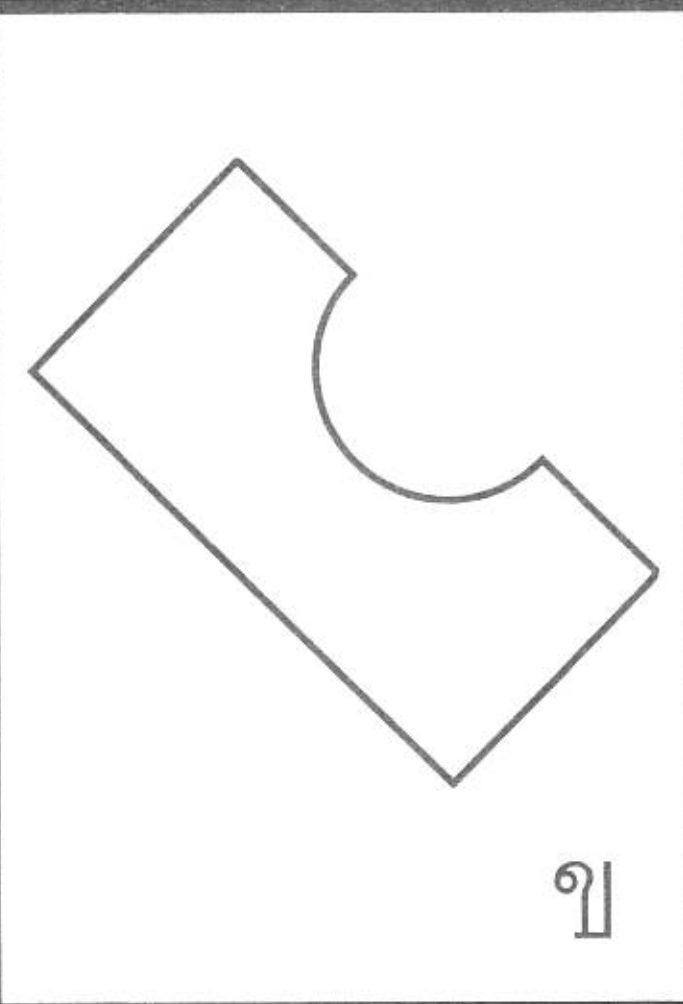
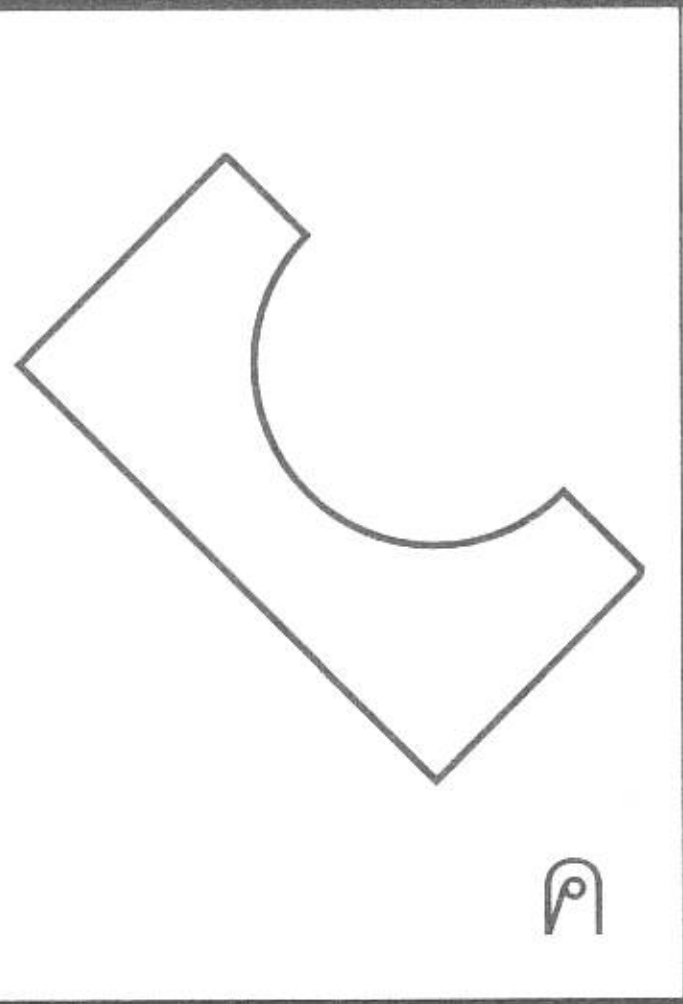
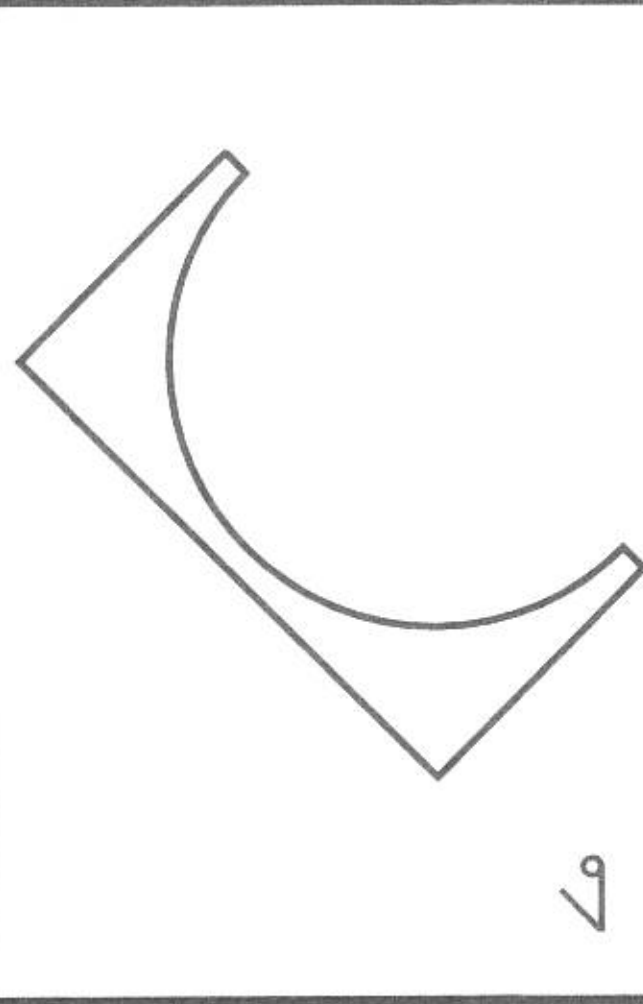
	 ก	 ข	 ค	 ง
---	--	---	--	--

5

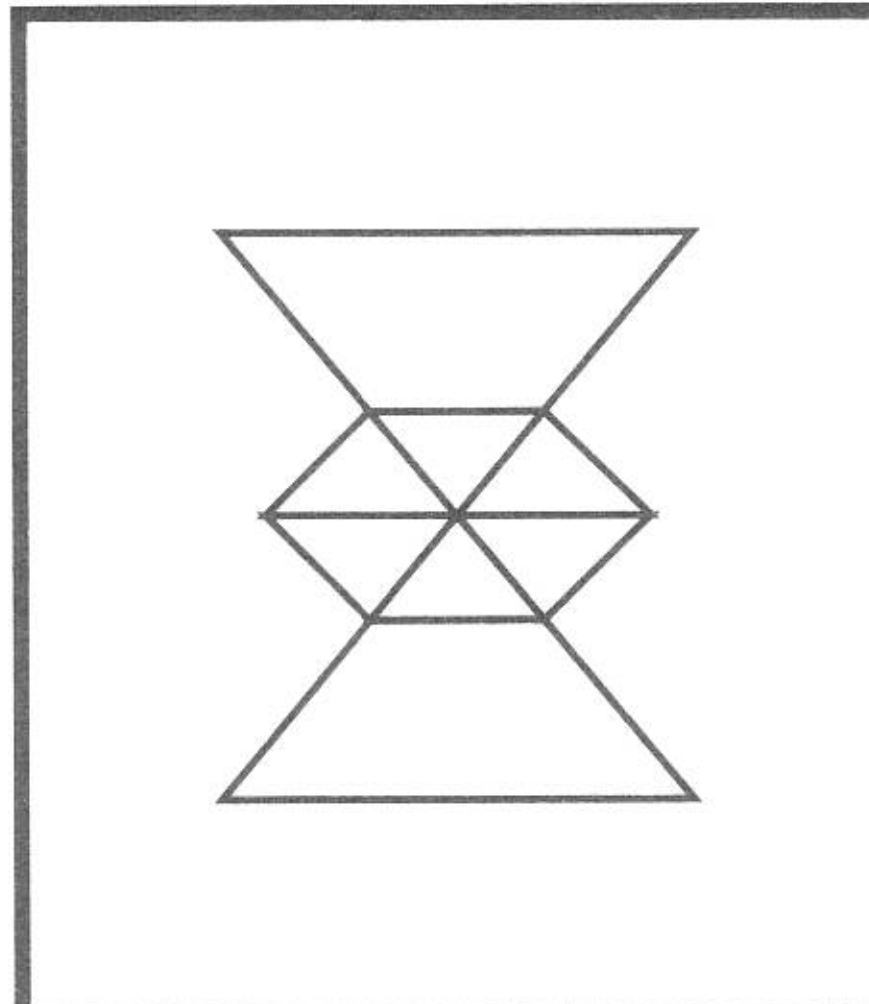
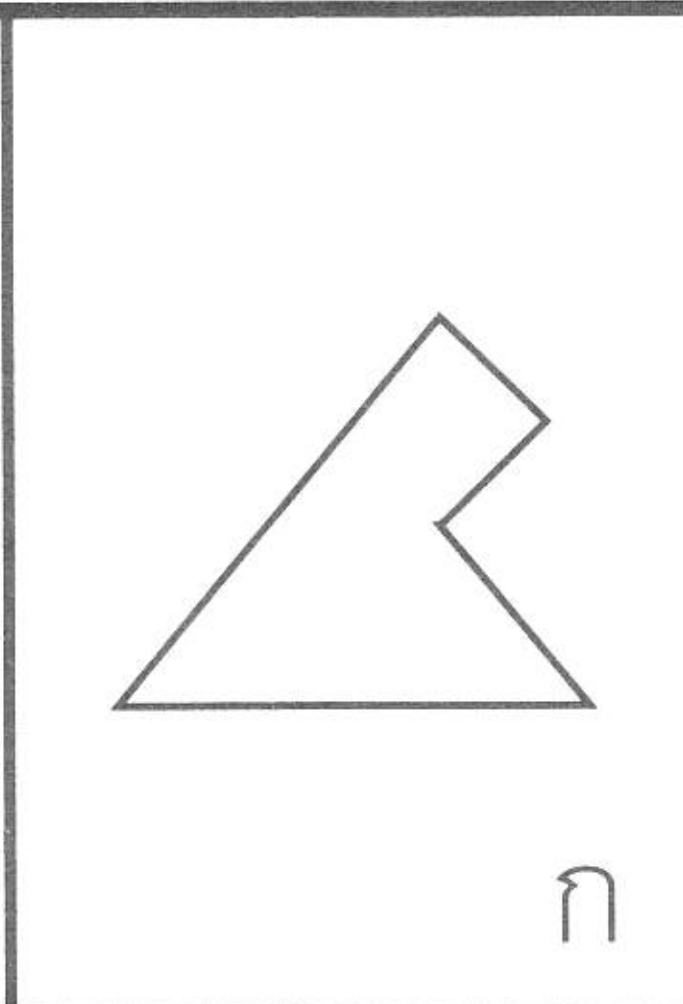
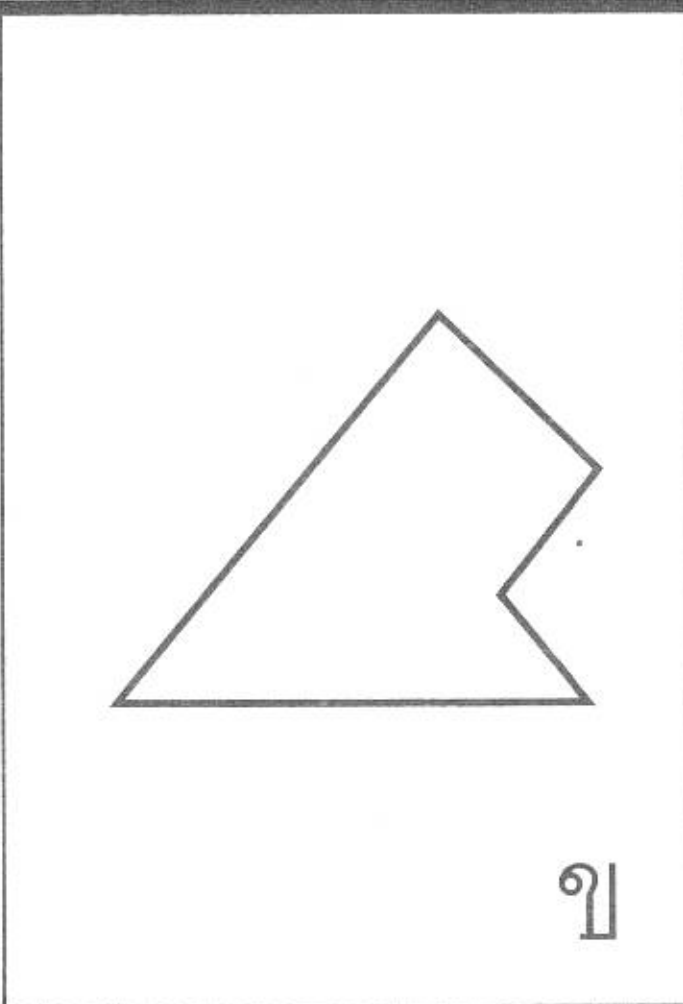
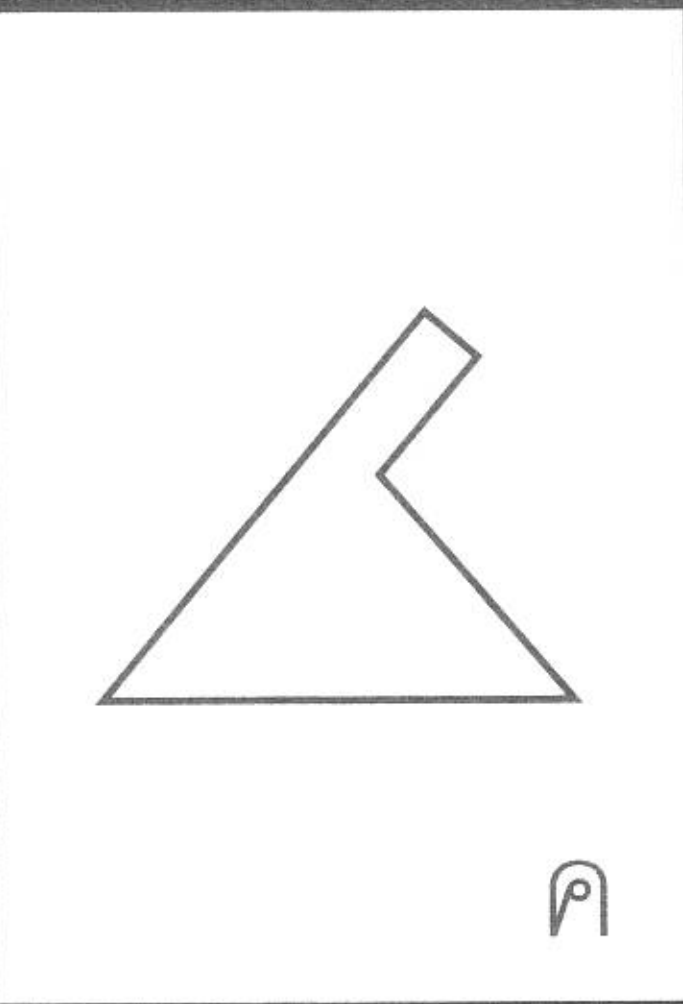
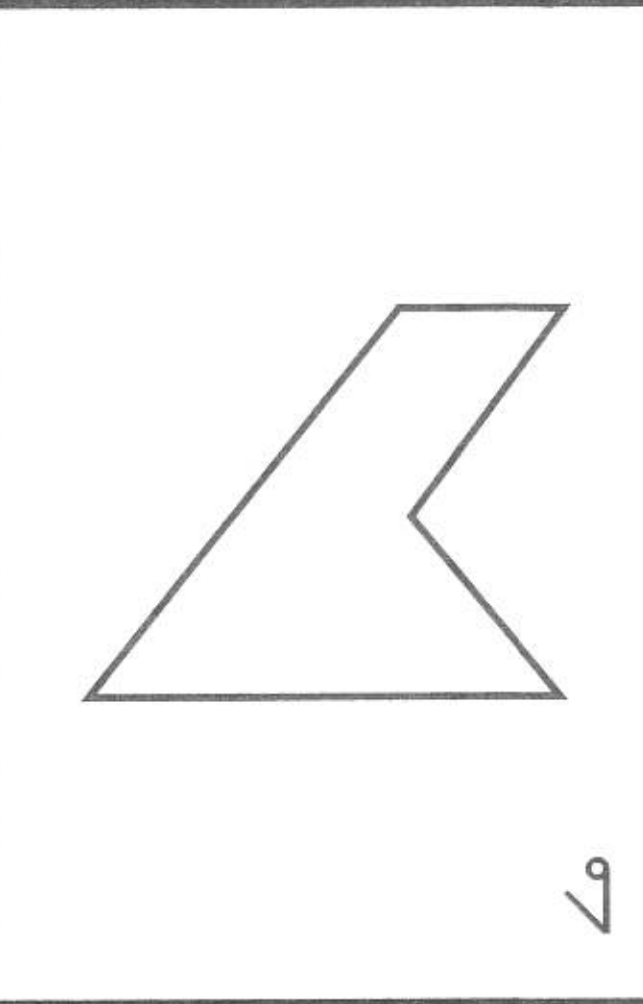
	 ก	 ข	 ค	 ง
---	--	---	--	--

6

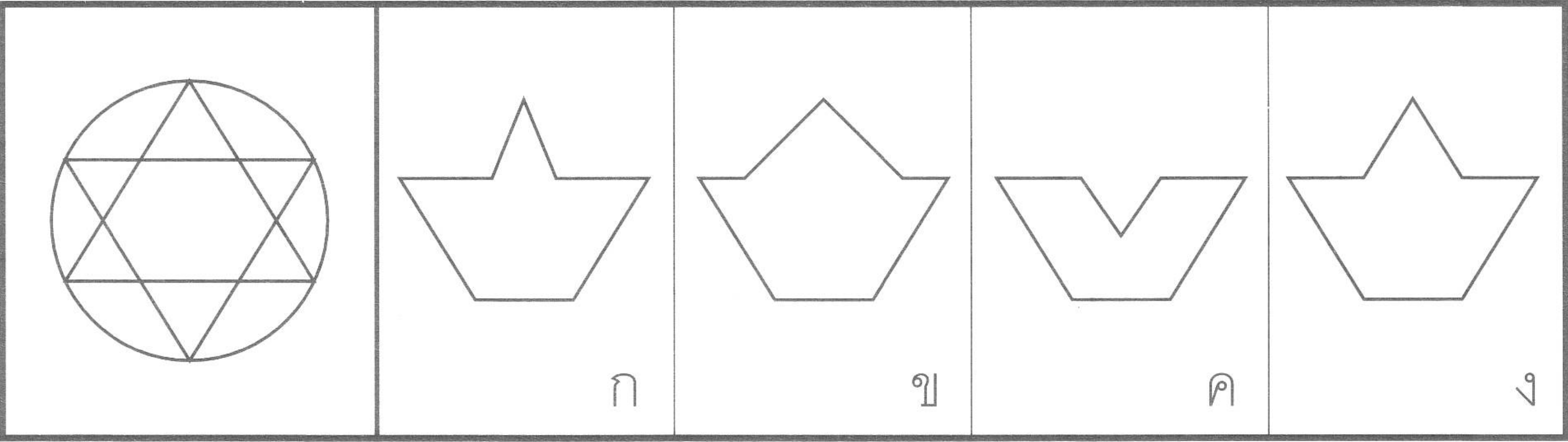

7

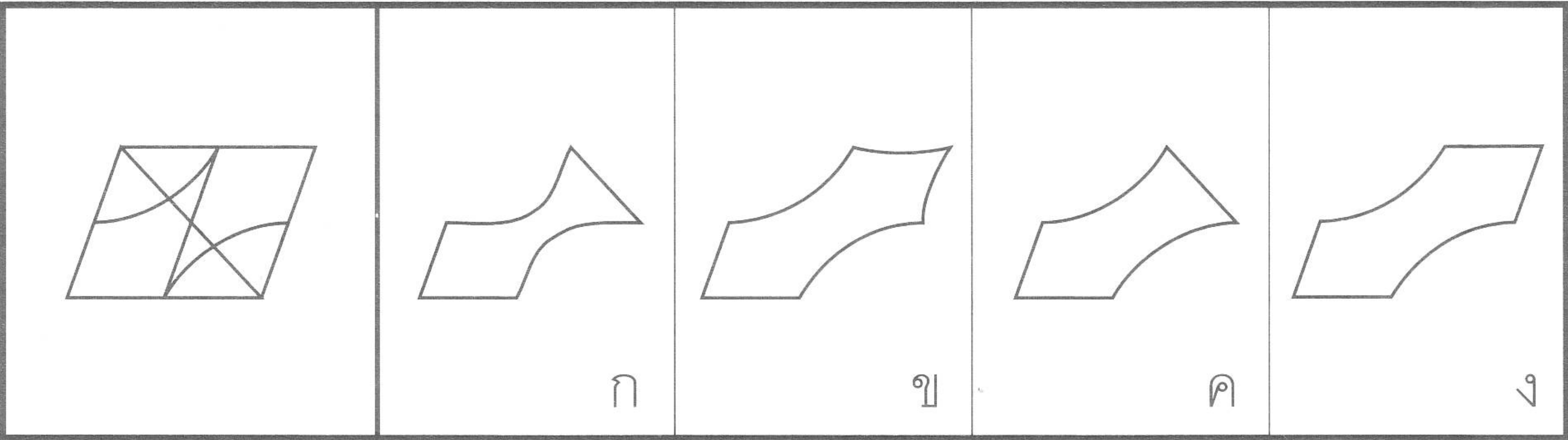

8

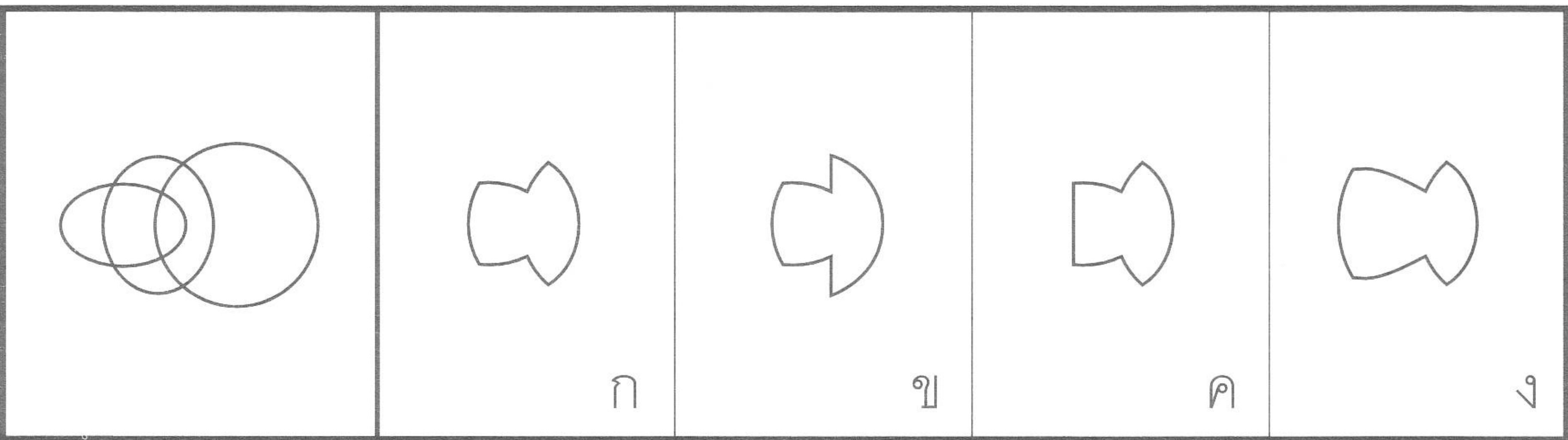

9

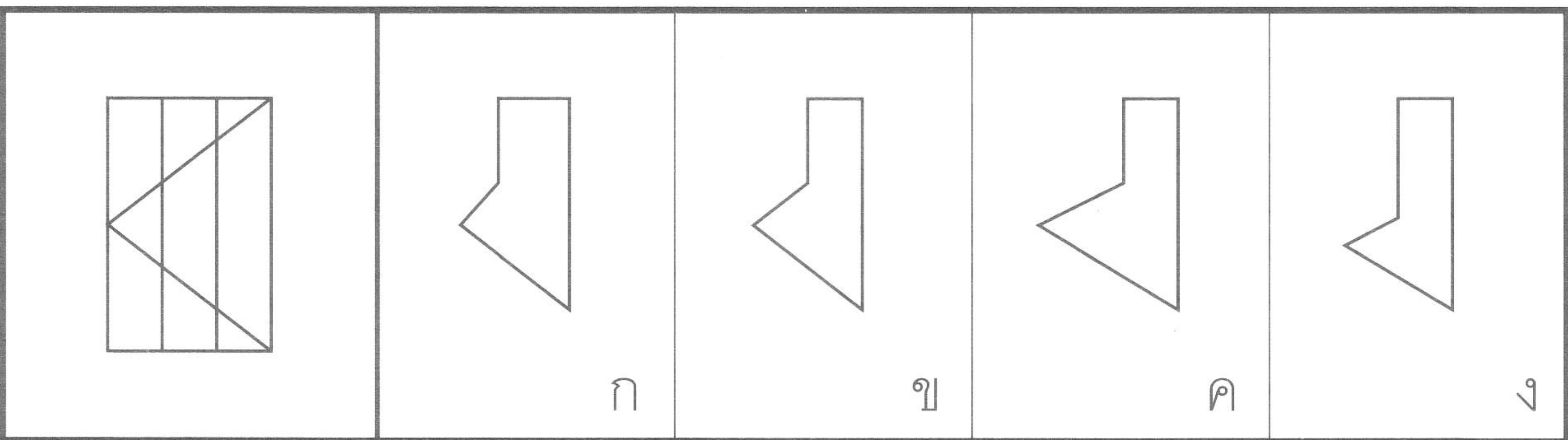

10

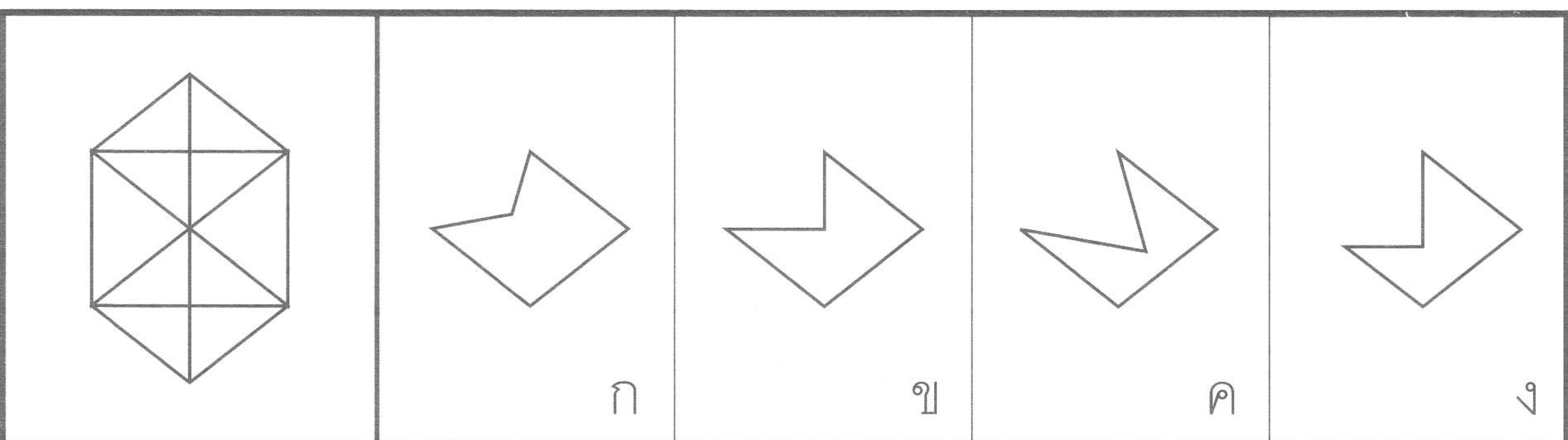

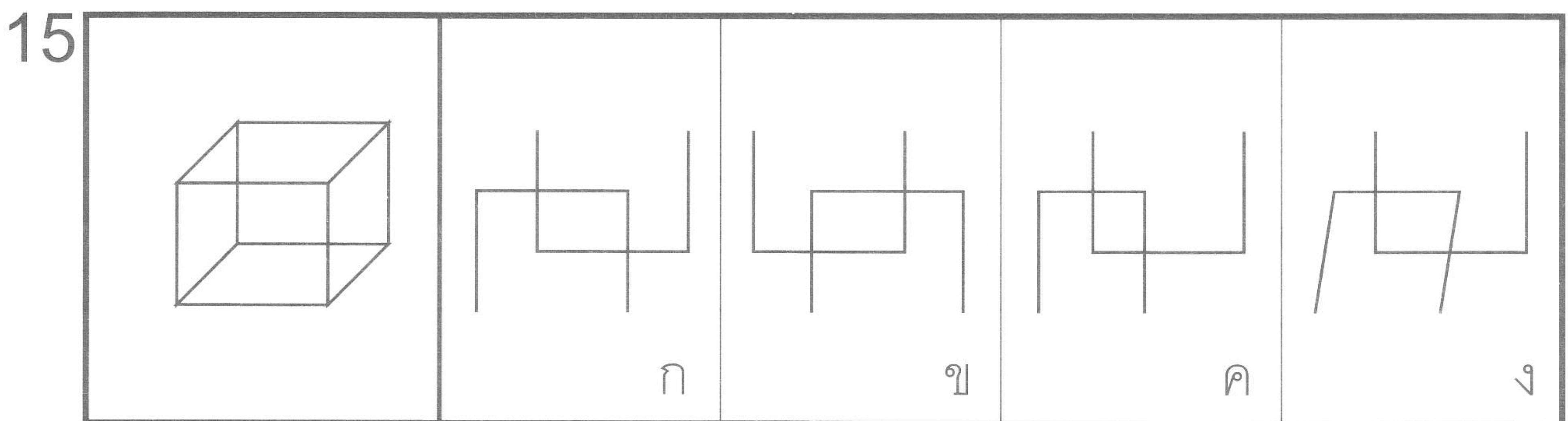
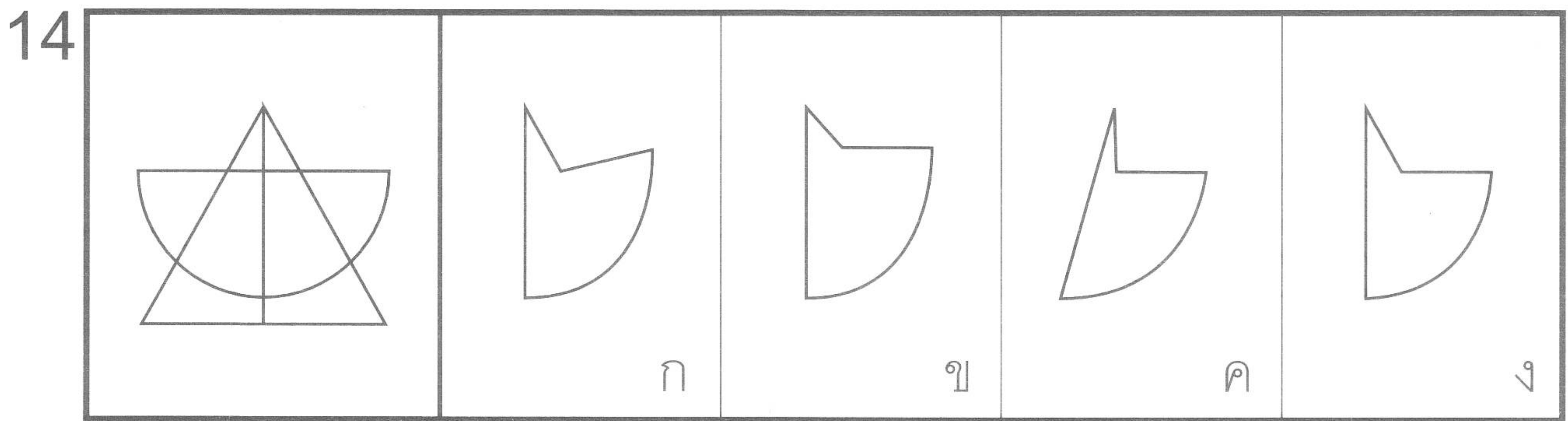
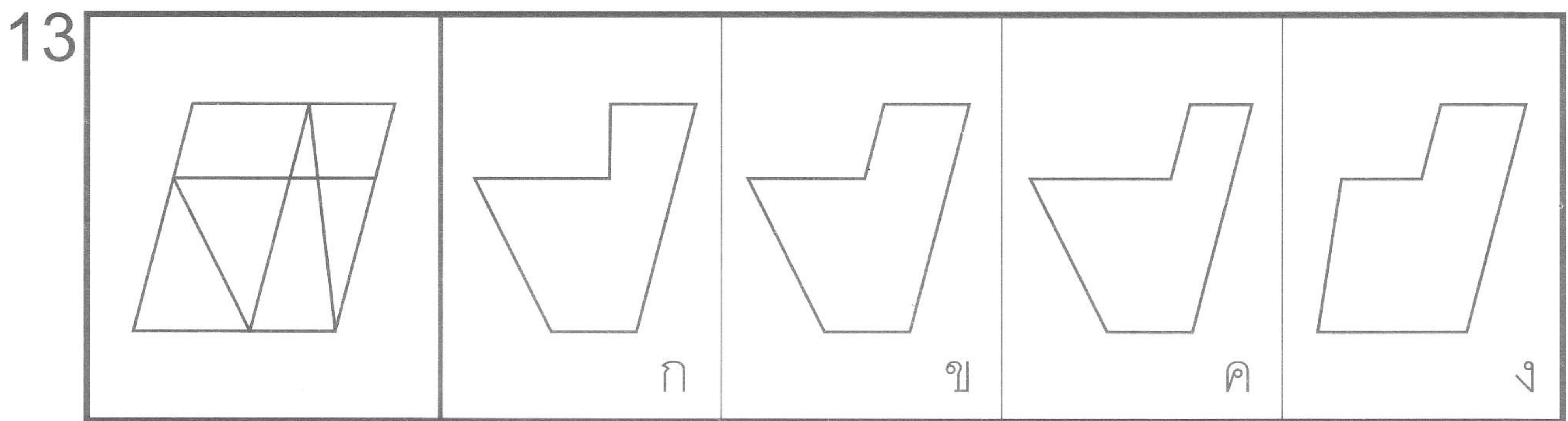
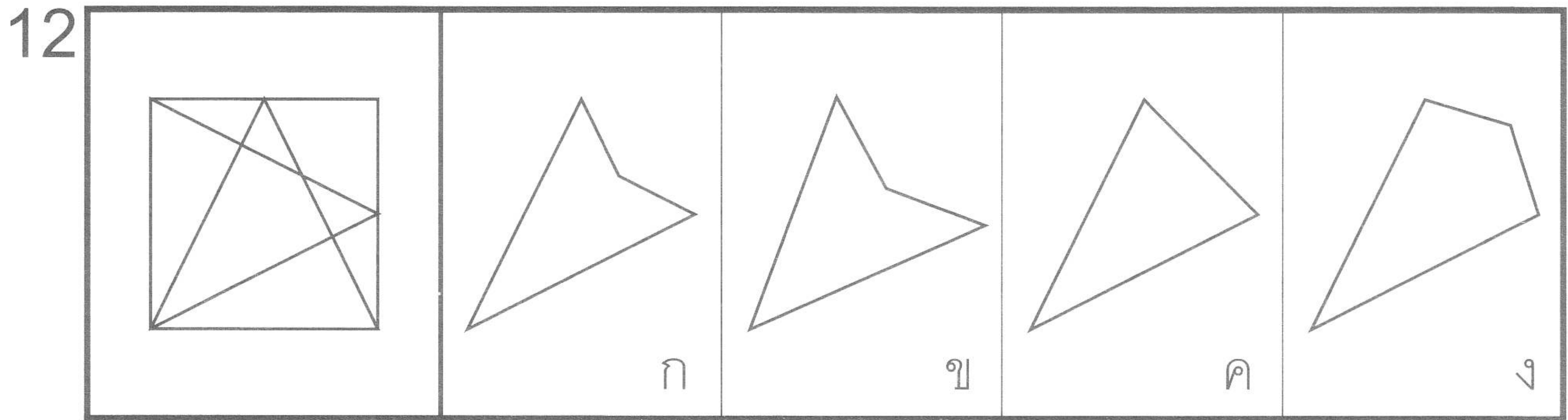
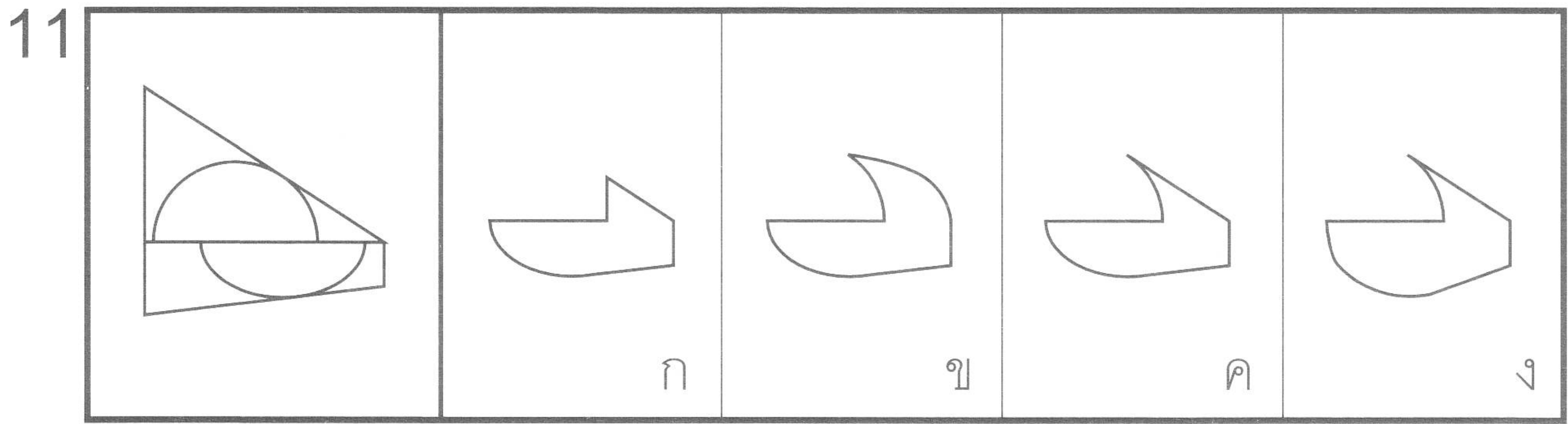

16

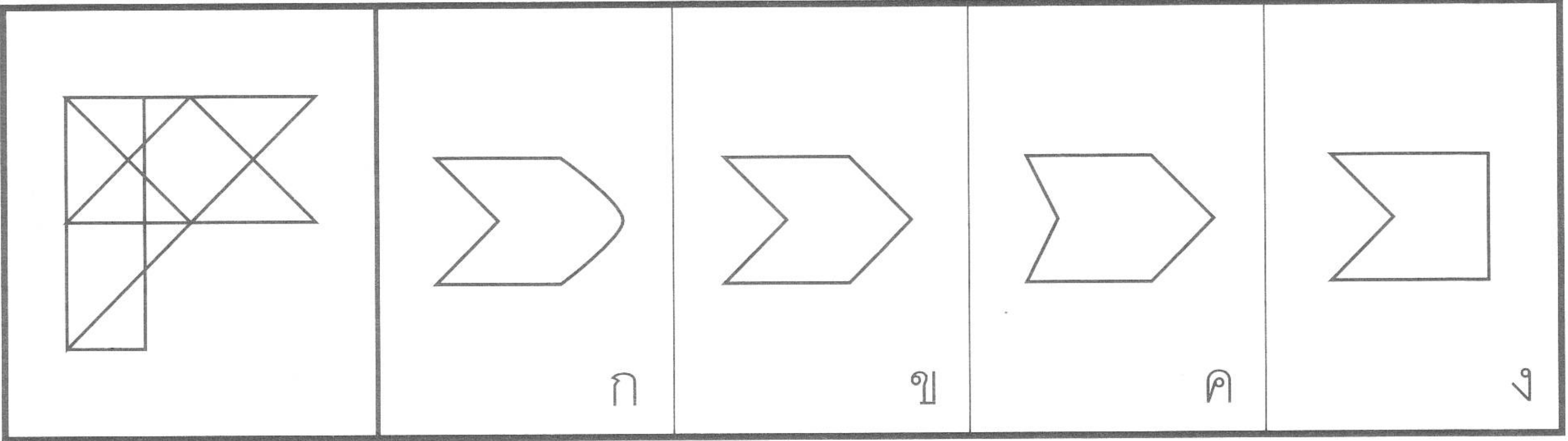

17

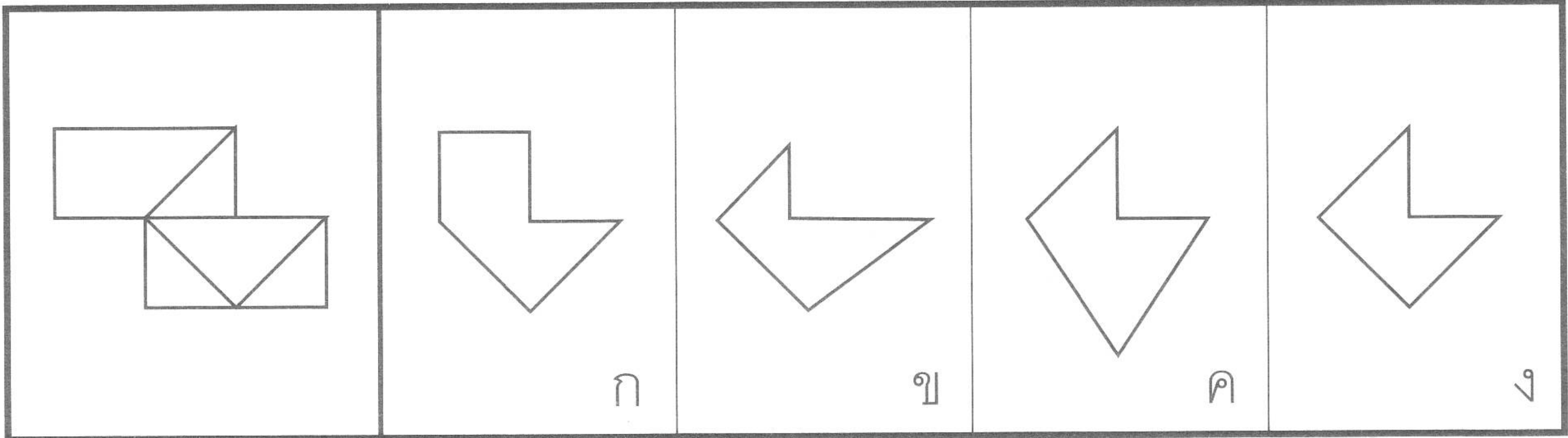

18

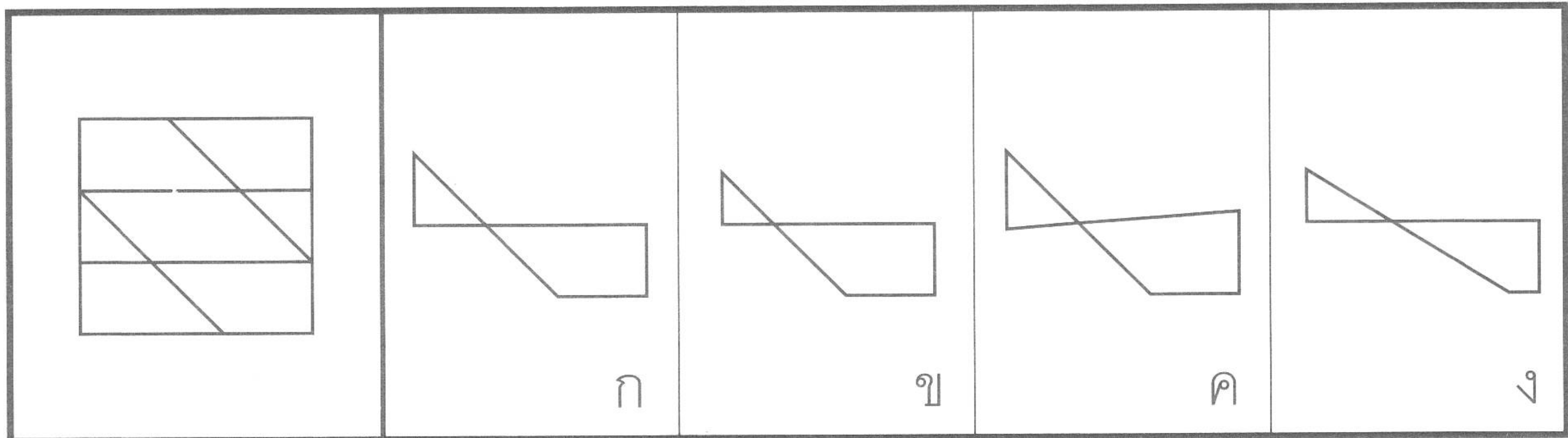

19

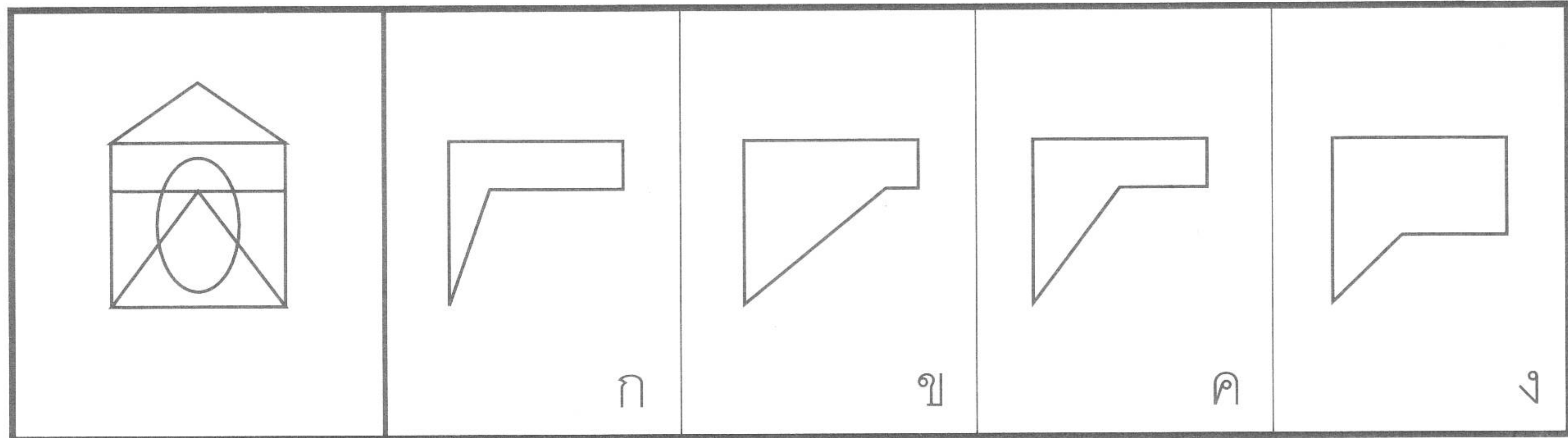

20

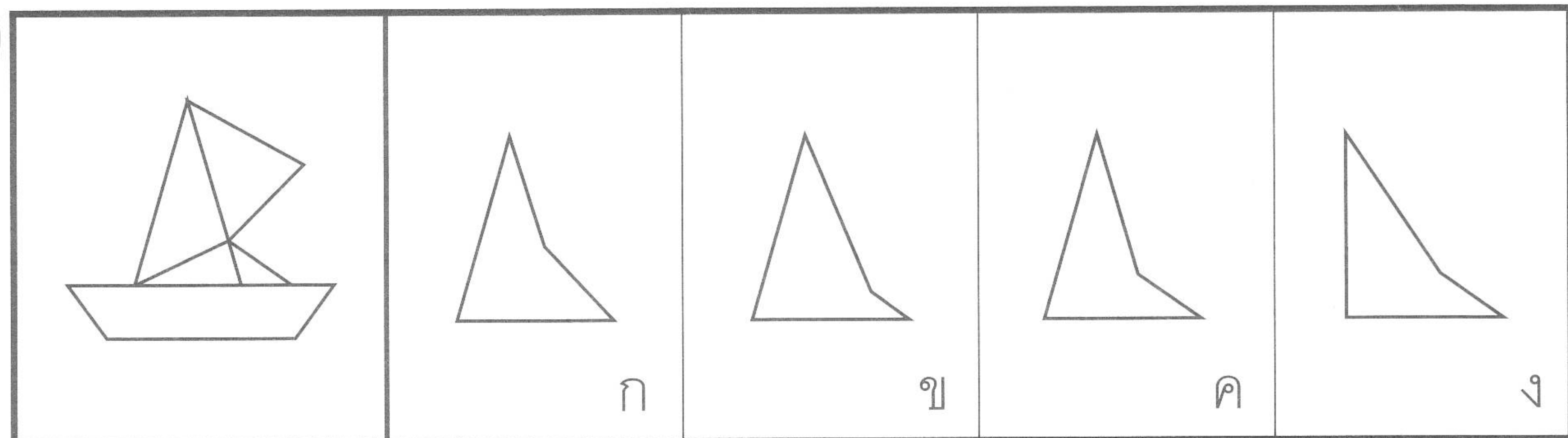

จงขีด X ภาพที่เกิดจากการรวมกันของภาพที่กำหนด

1

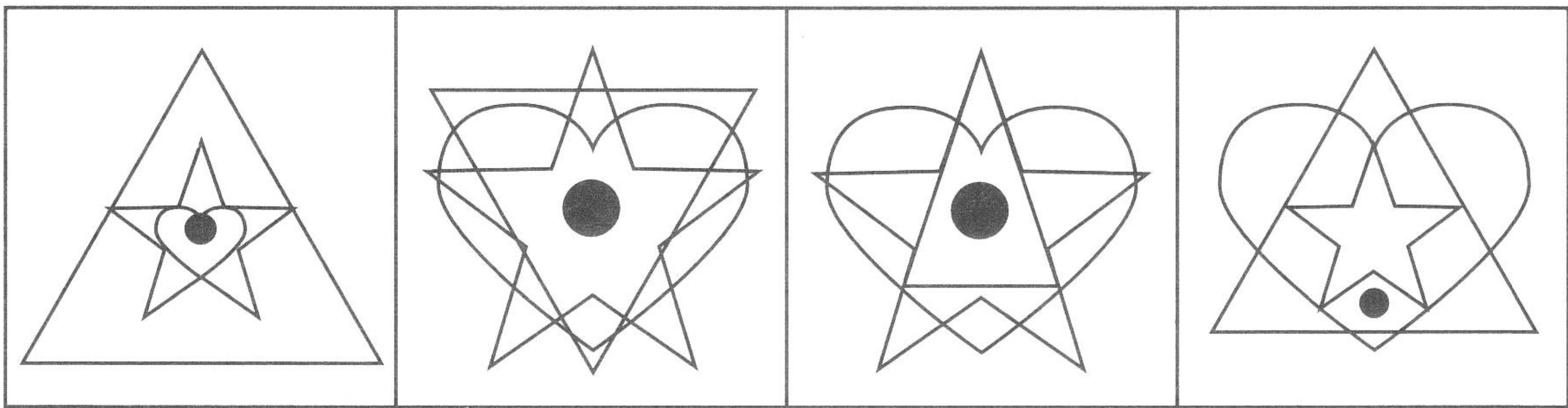
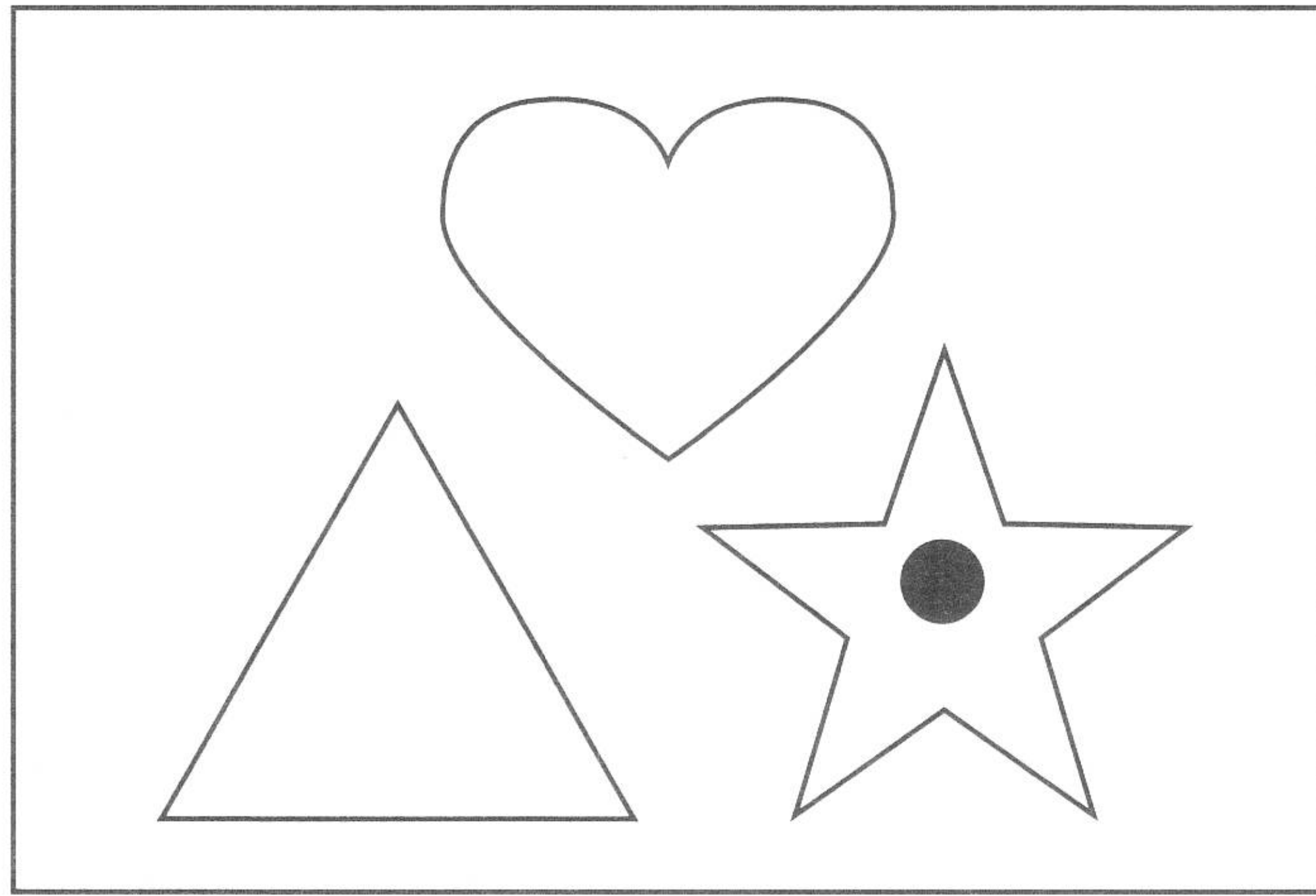

ก

ข

ค

ง

2

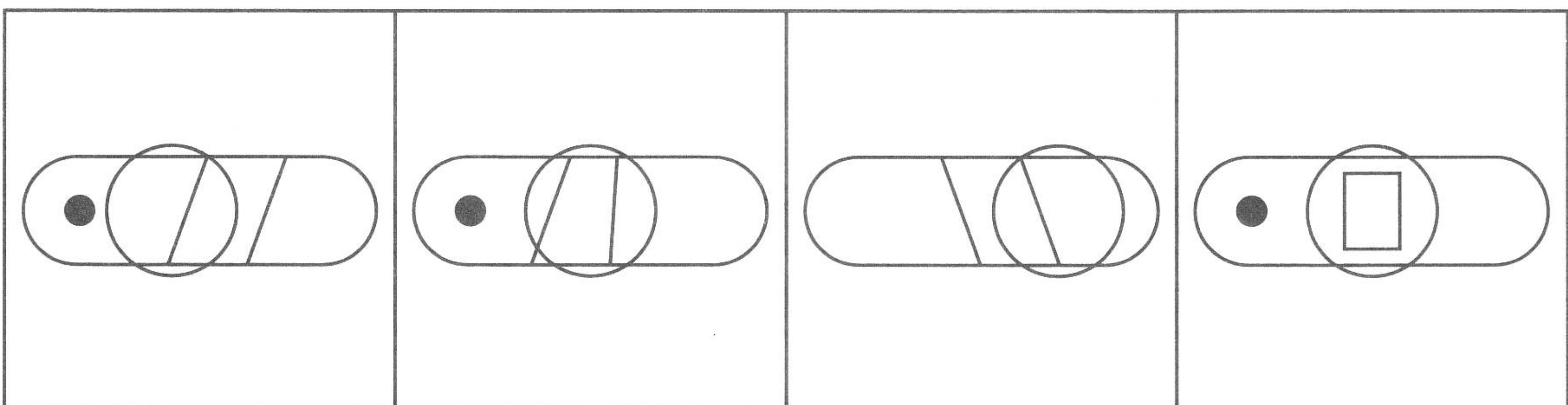
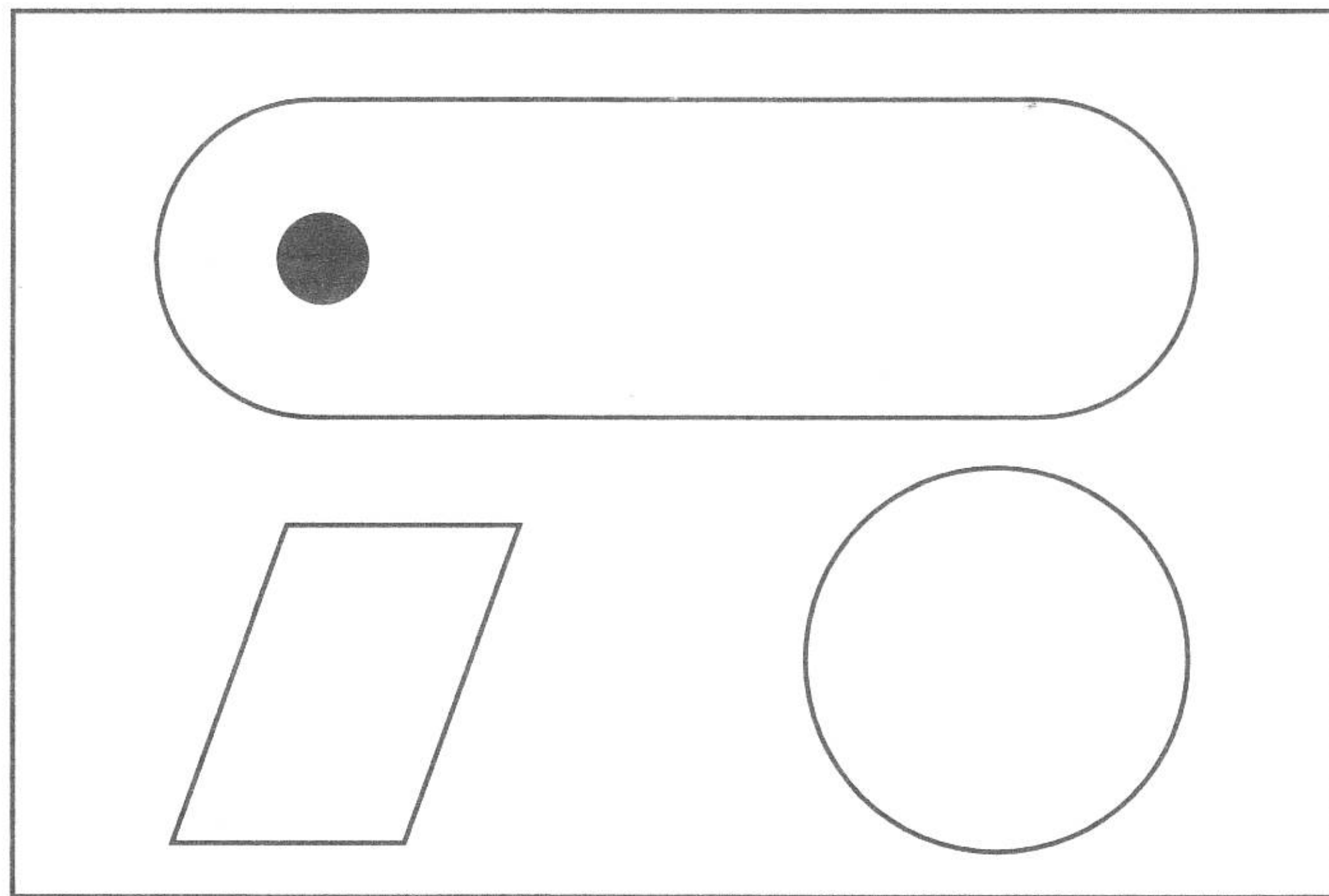

ก

ข

ค

ง

3

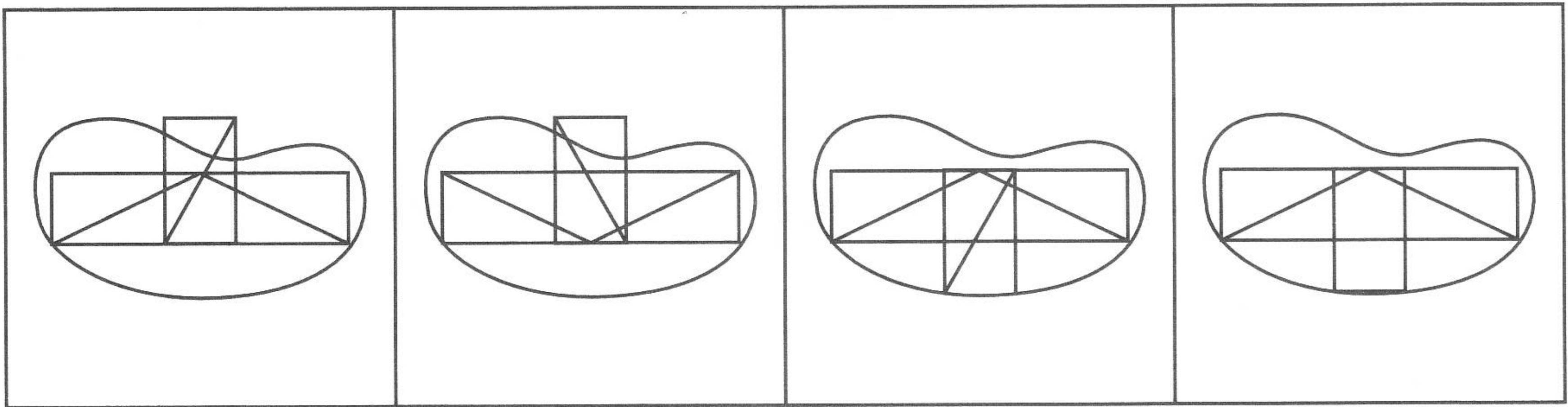
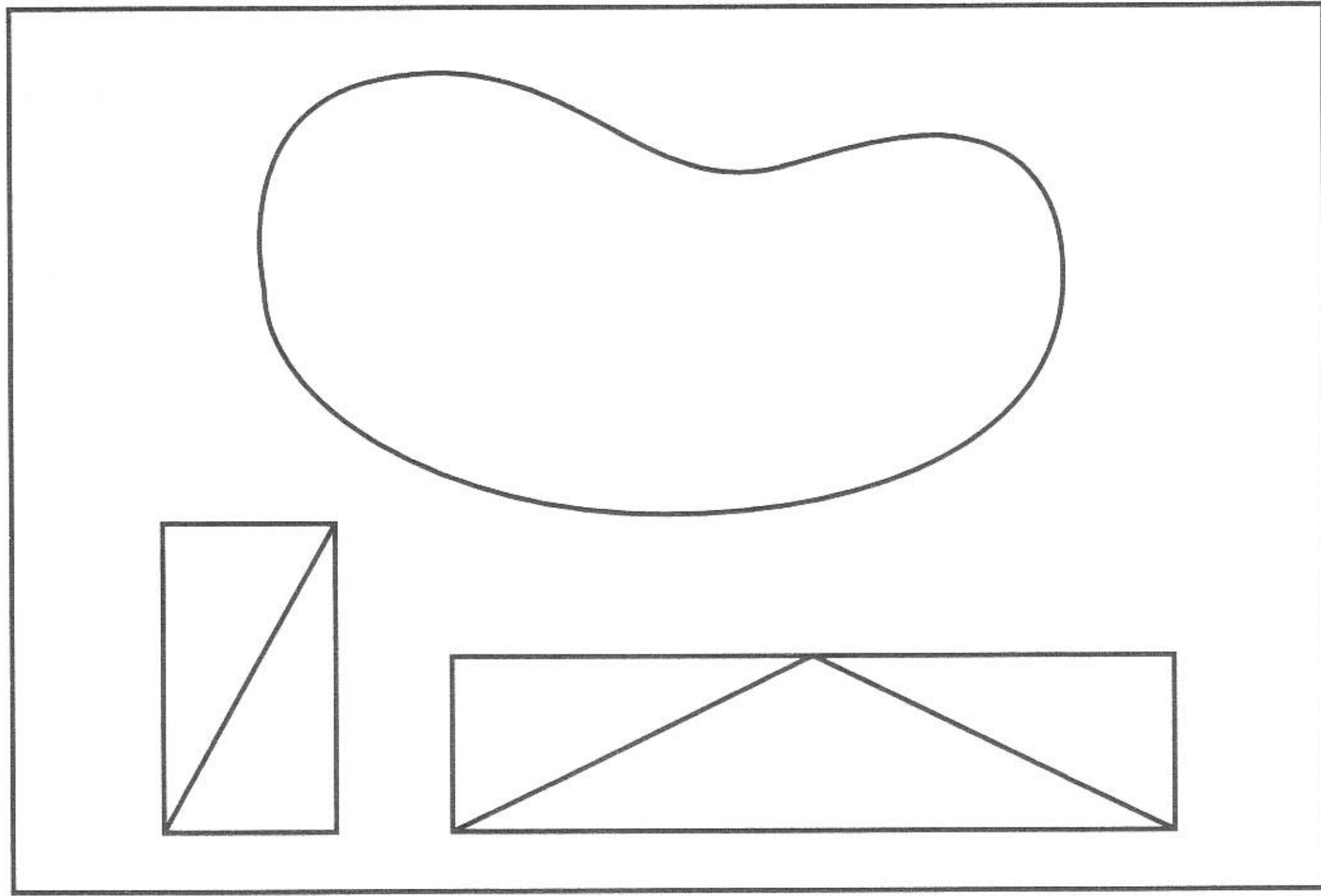

ก

ข

ค

ง

4

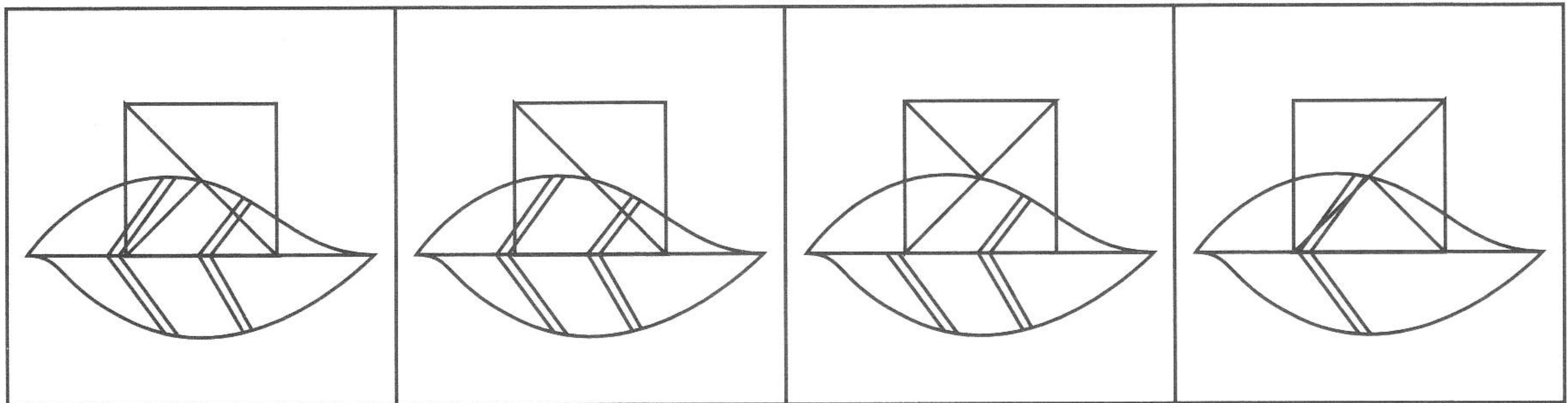
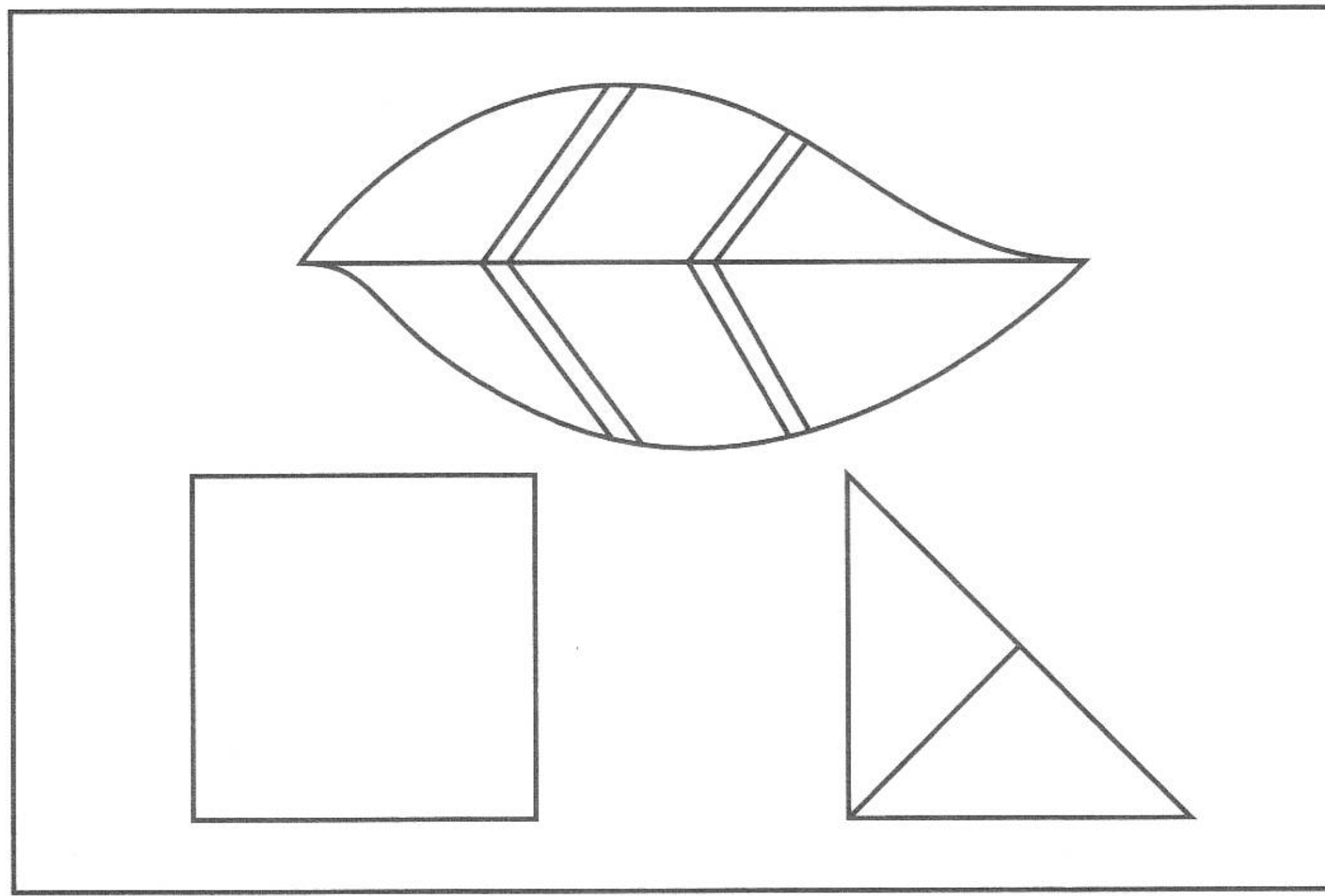

ก

ข

ค

ง

5

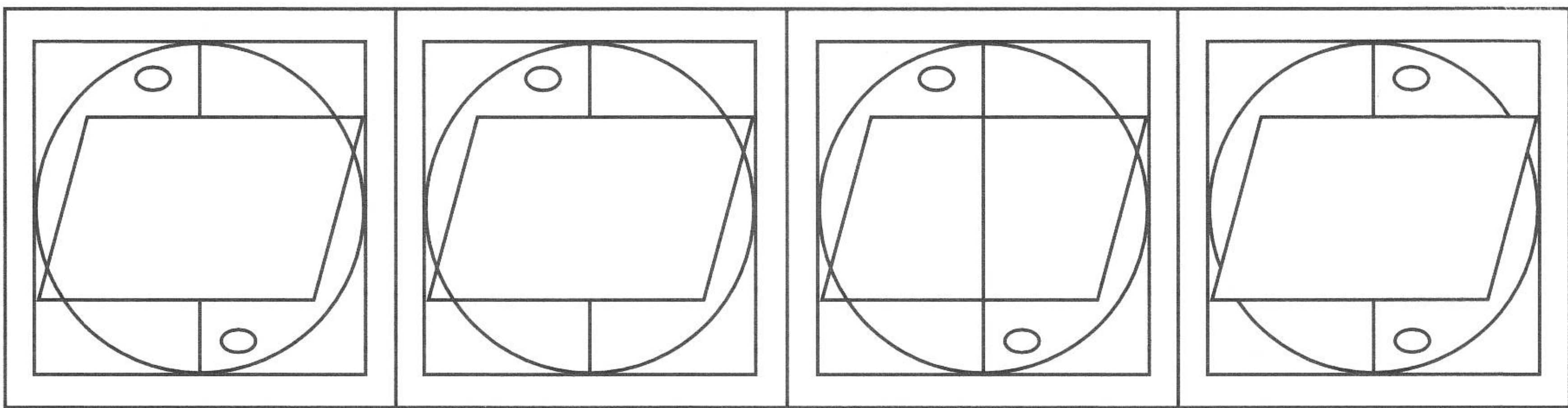
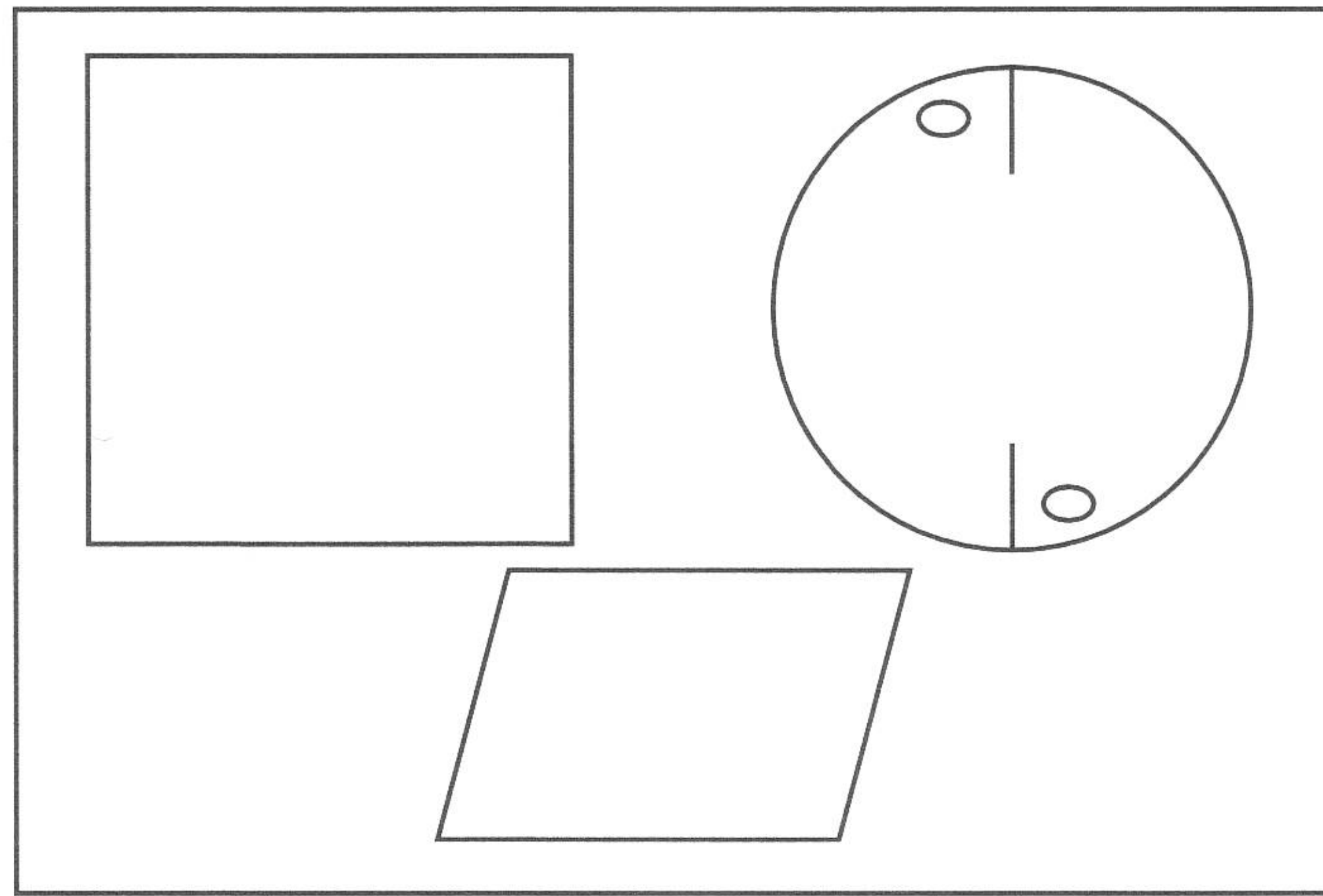

ก

ข

ค

ง

6

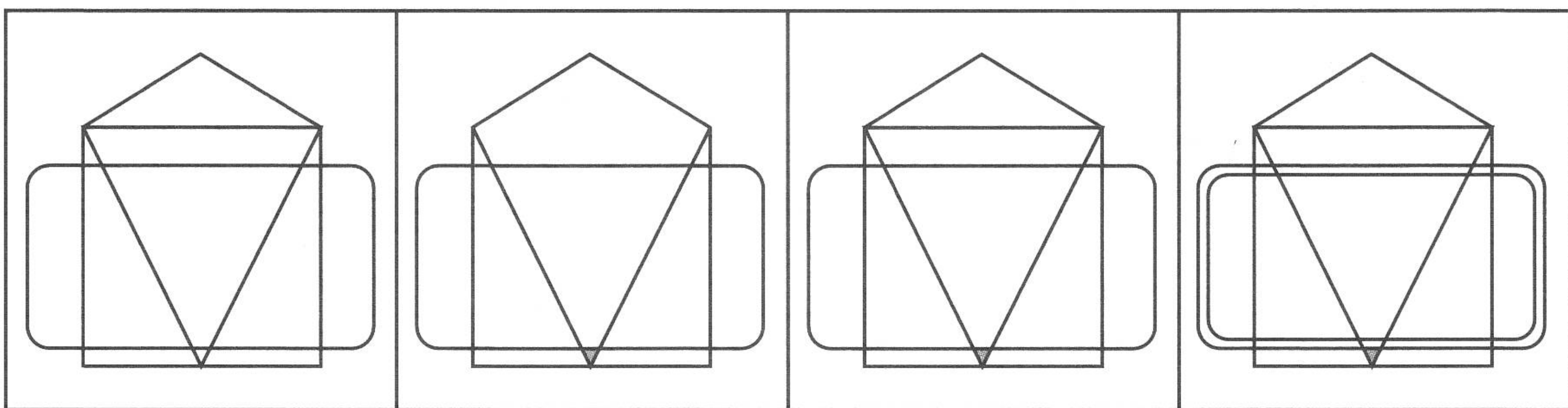
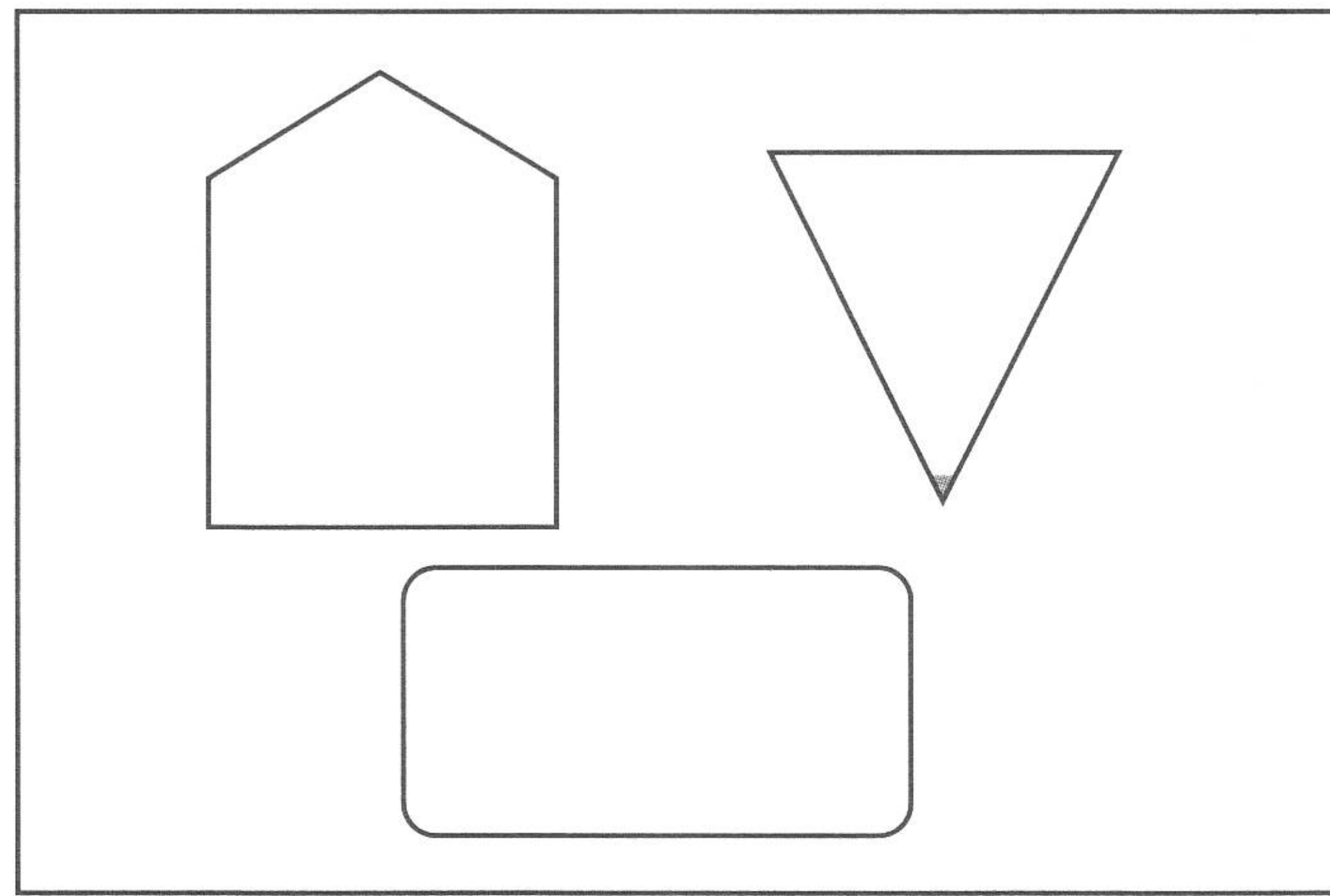

ก

ข

ค

ง

7

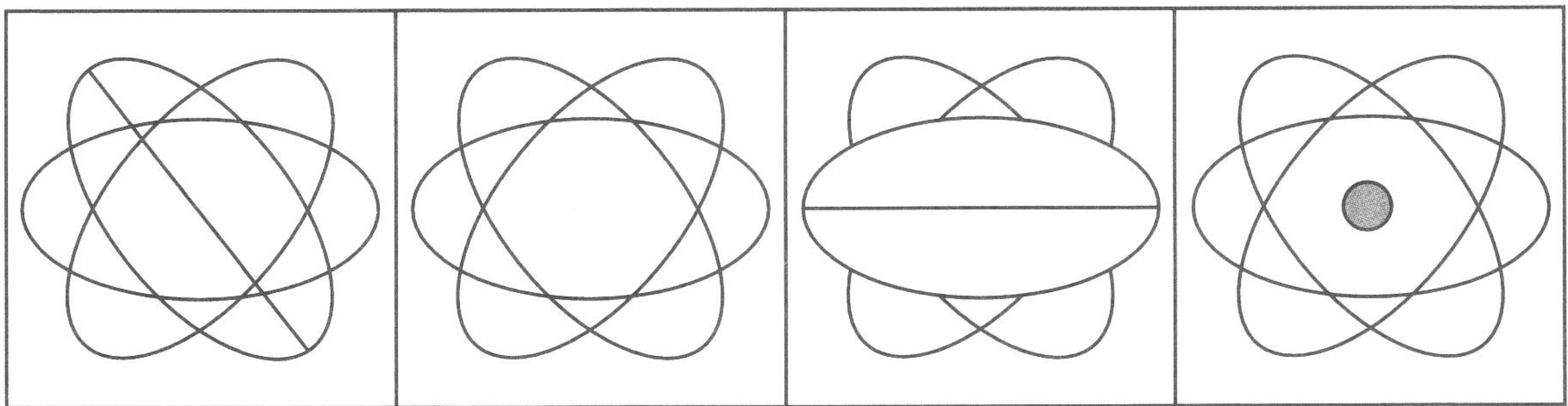
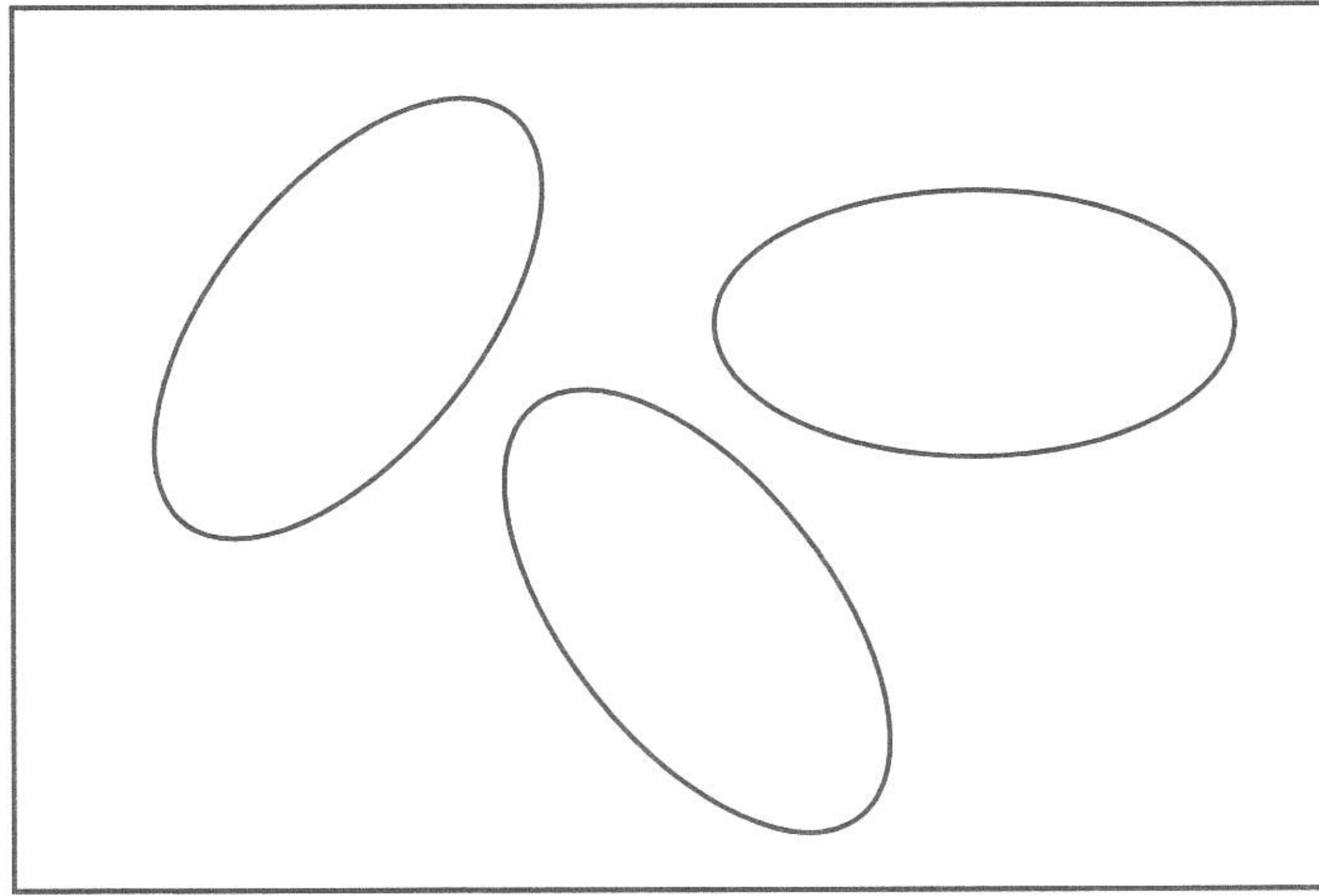

ก

ข

ค

ง

8

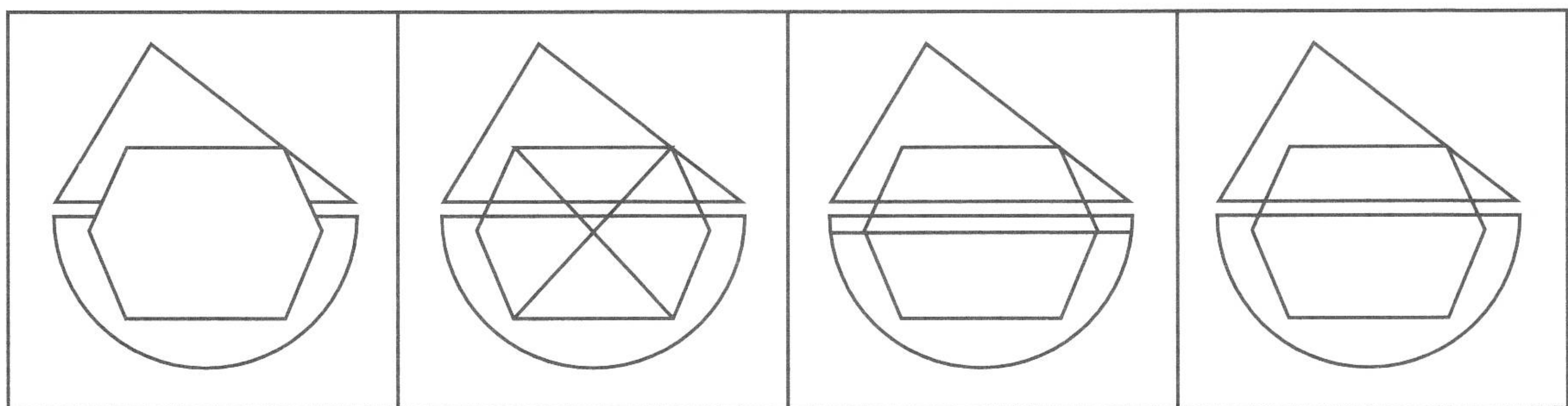
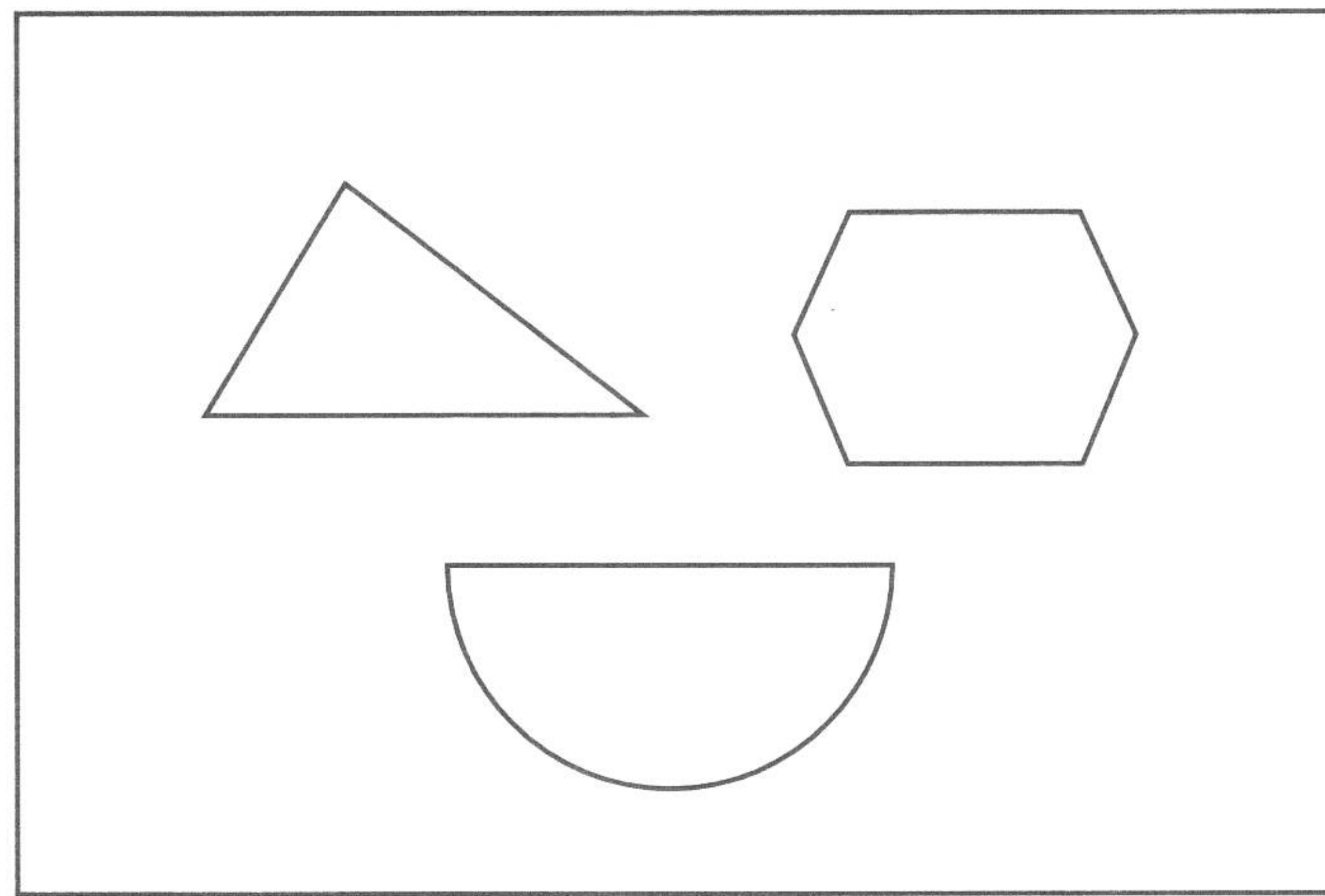

ก

ข

ค

ง

9

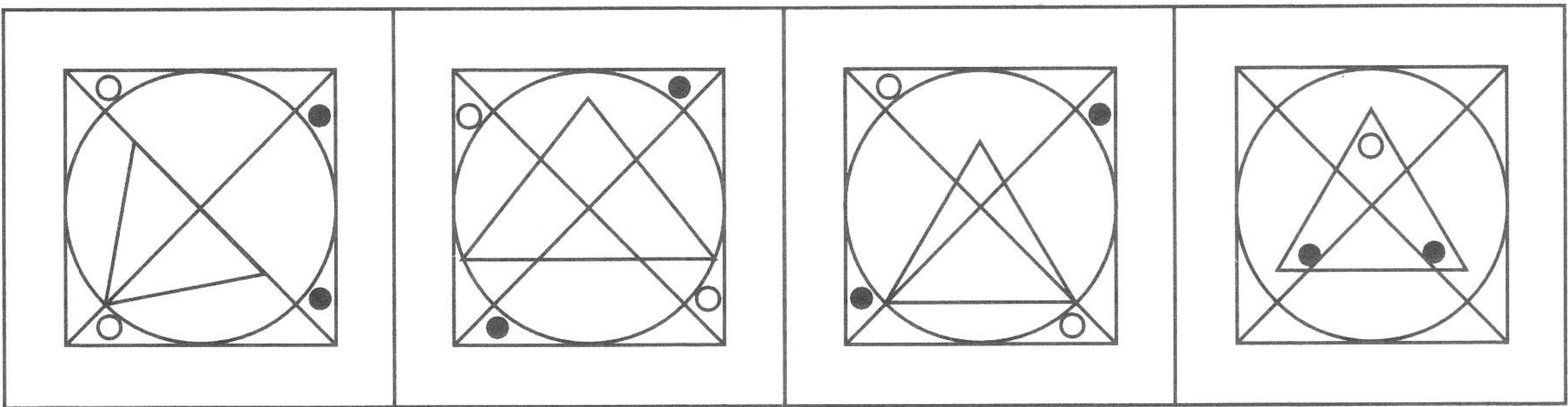
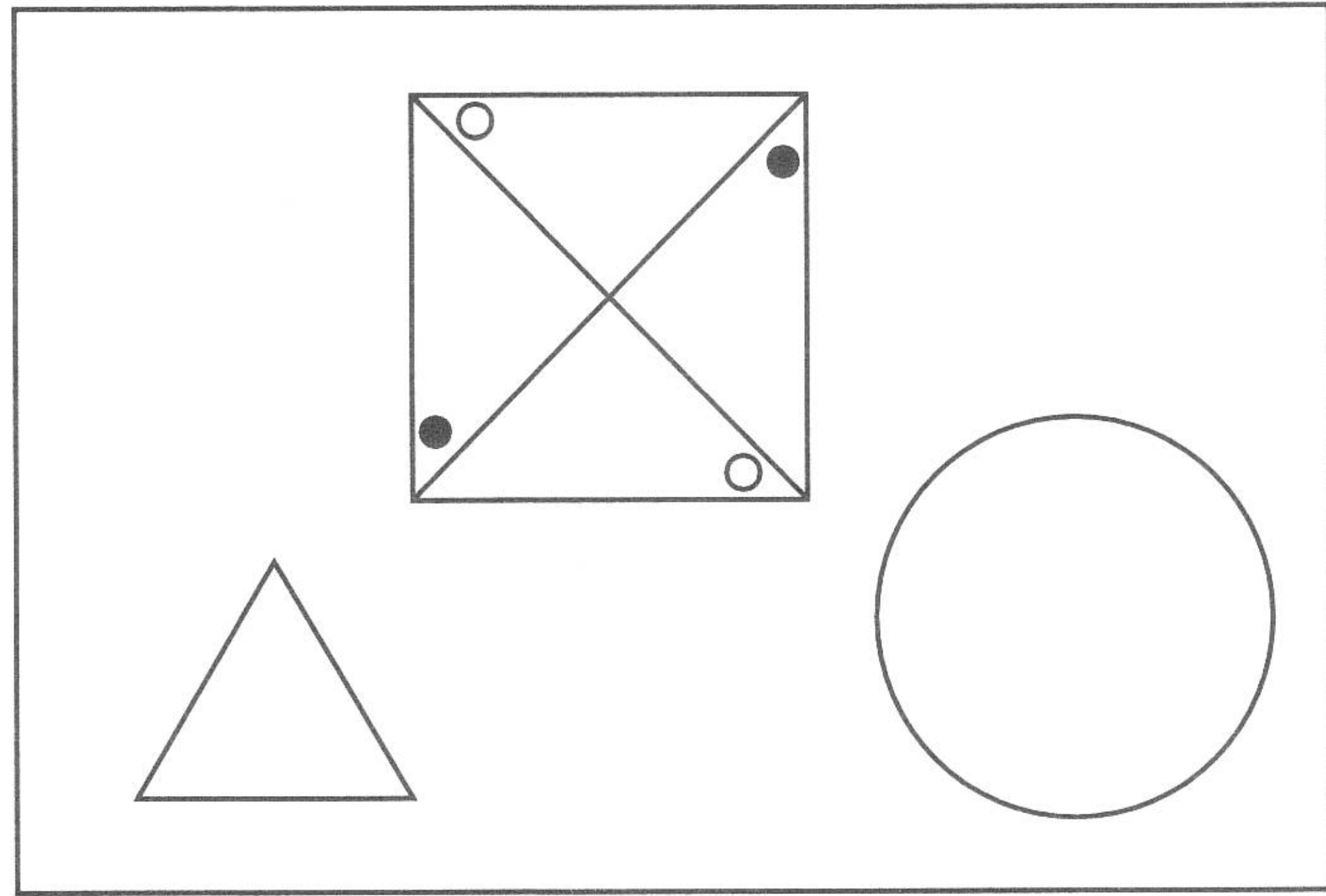

ก

ข

ค

ง

10

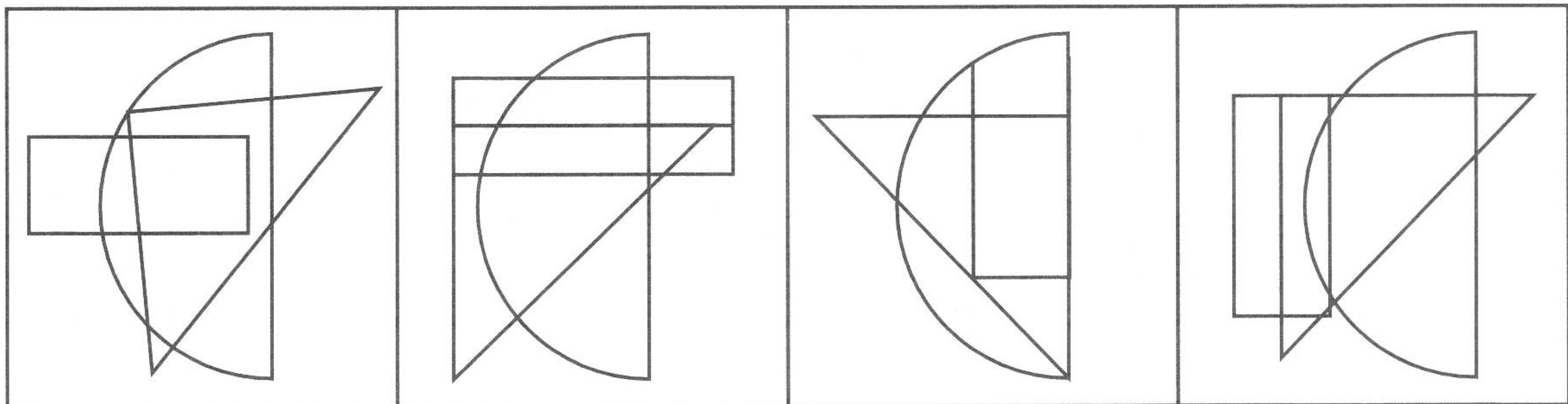
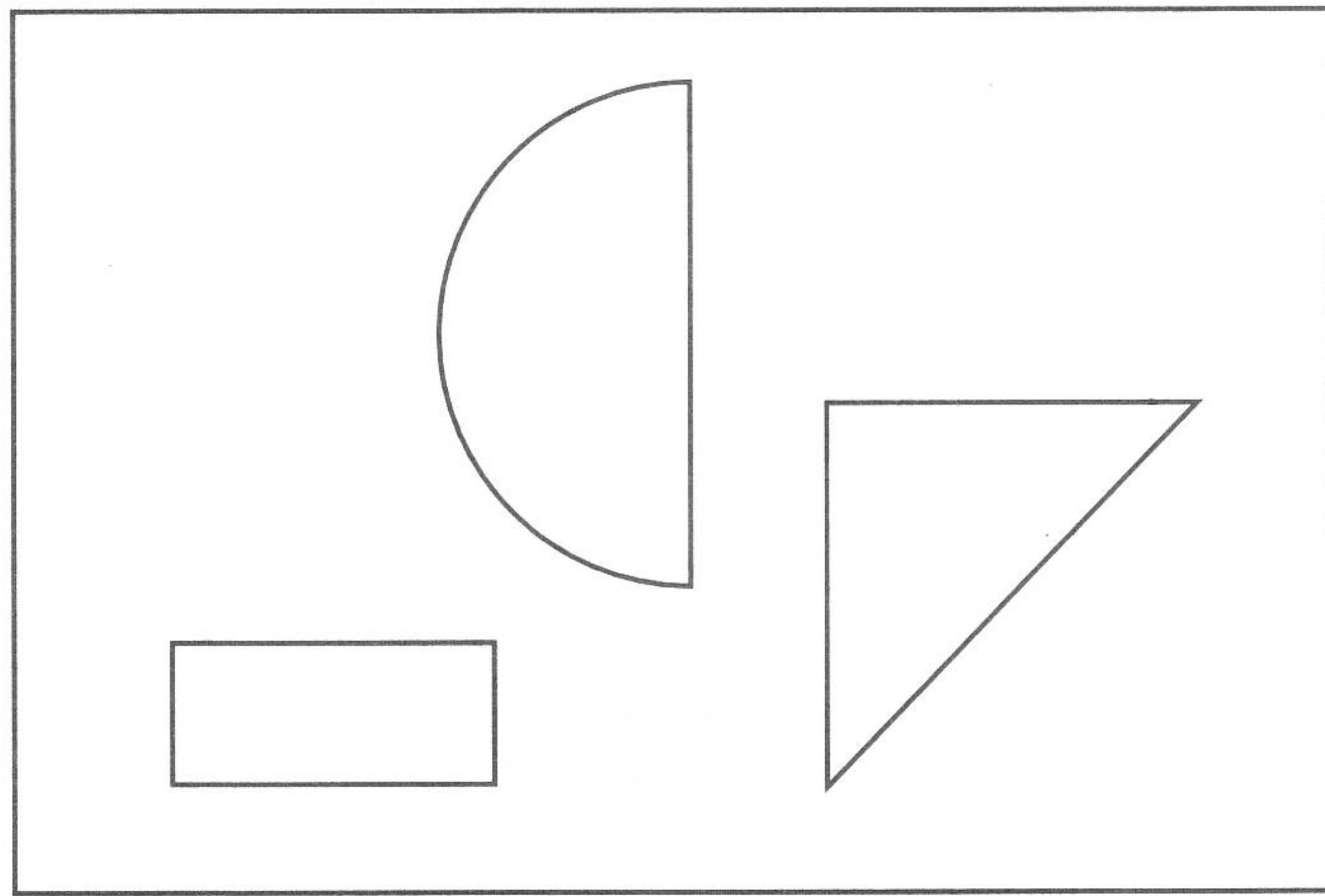

ก

ข

ค

ง

11

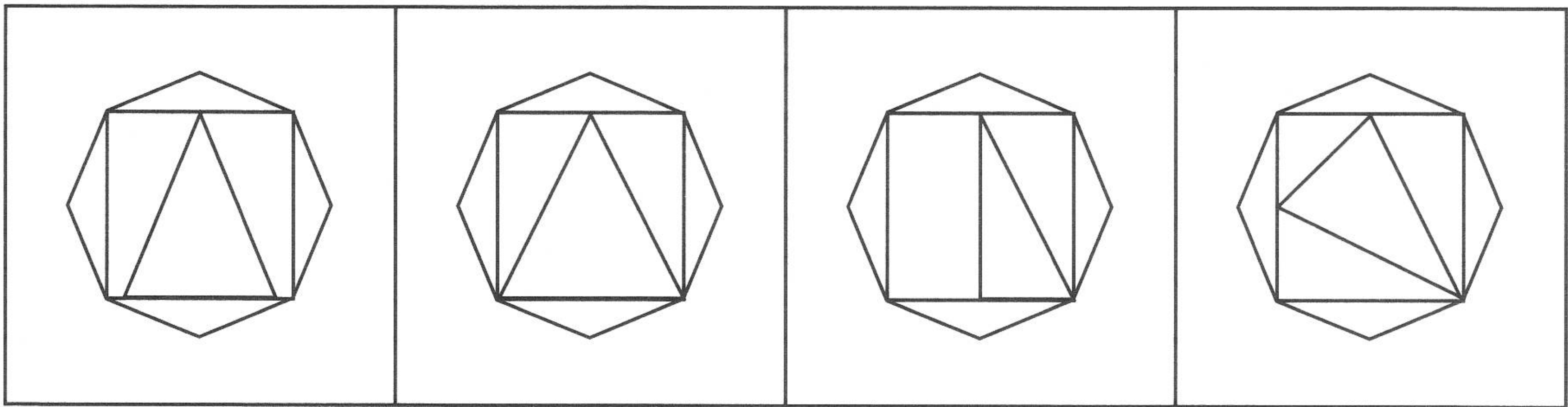
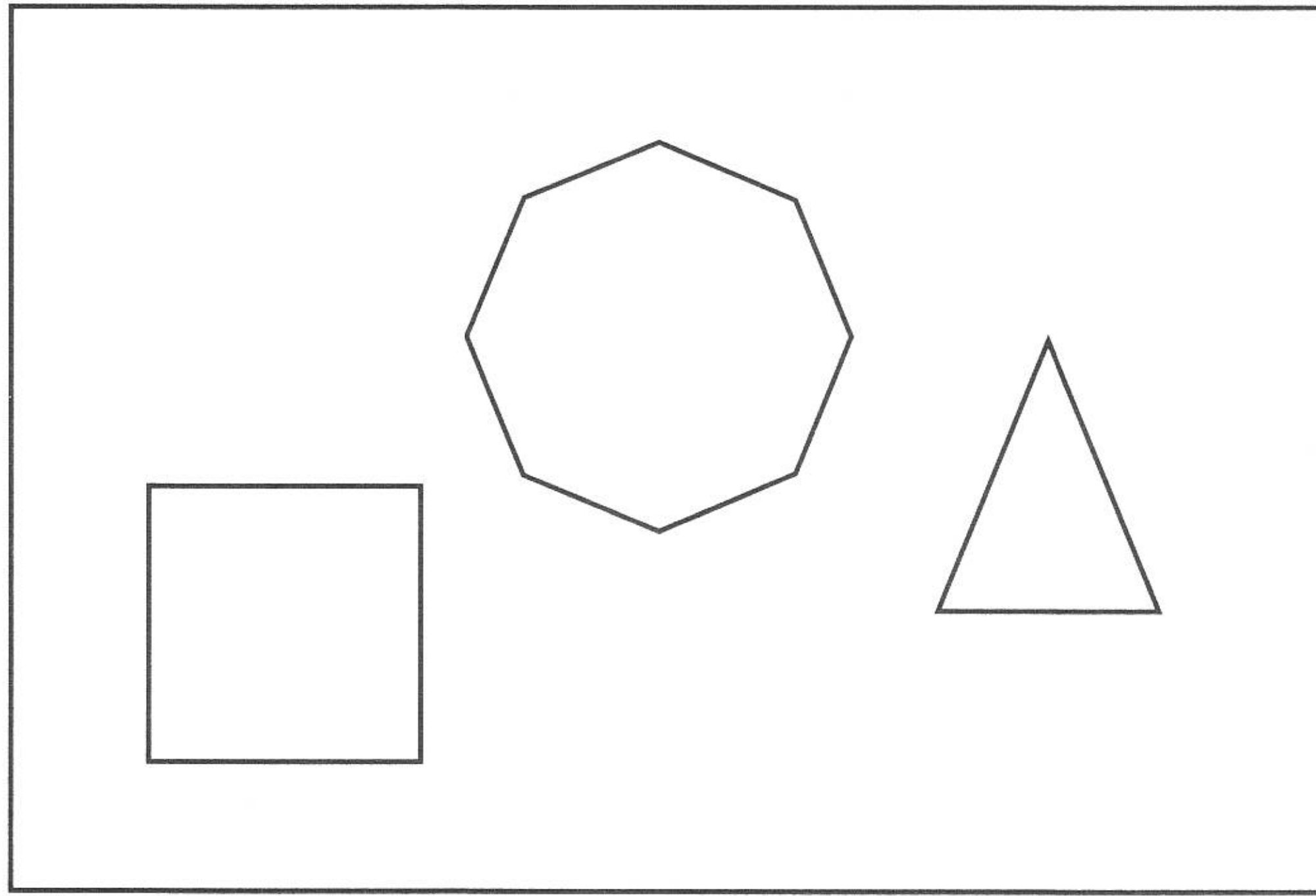

ก

ข

ค

ง

12

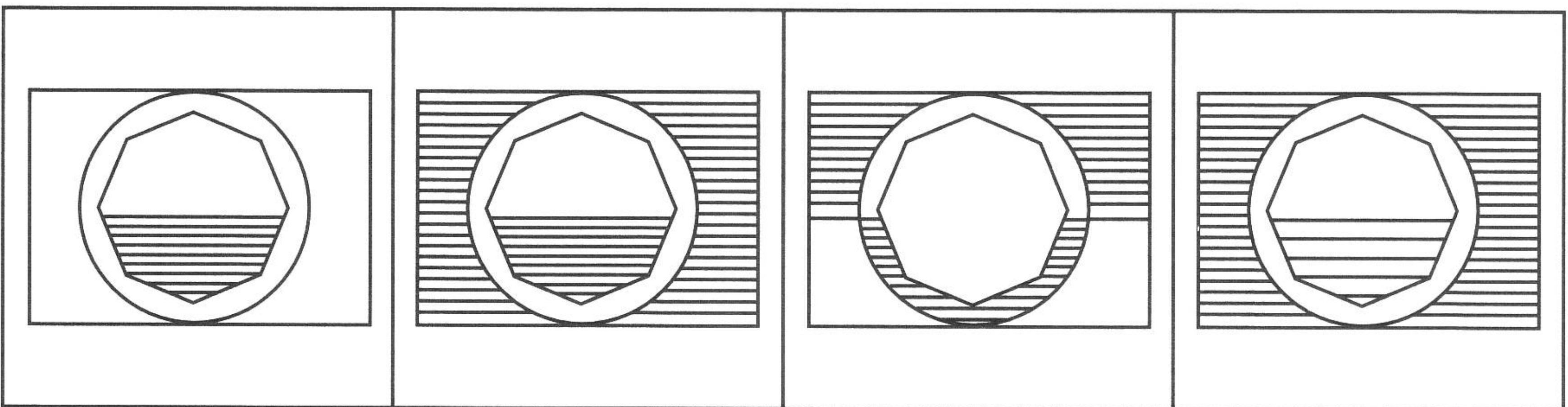
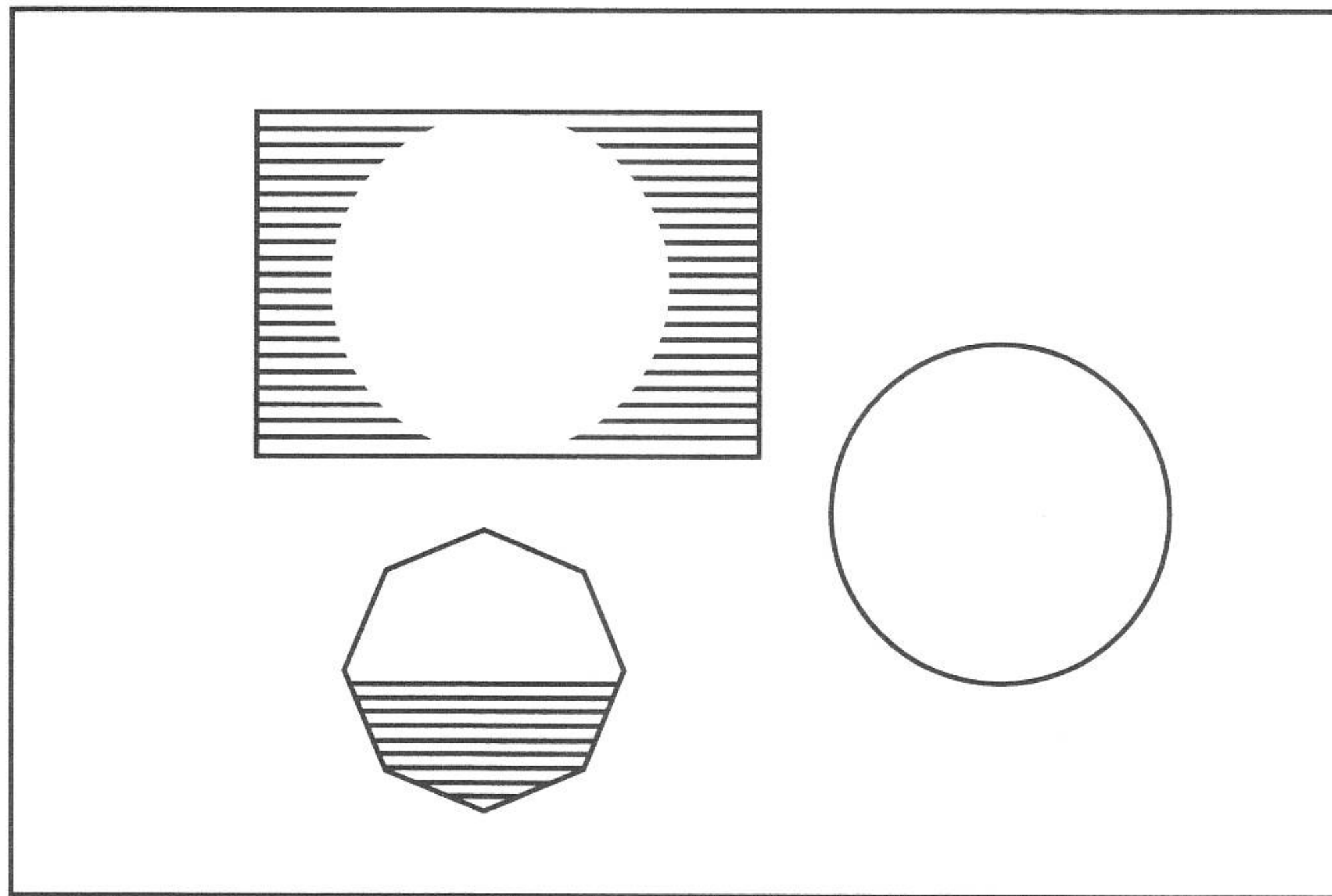

ก

ข

ค

ง

13

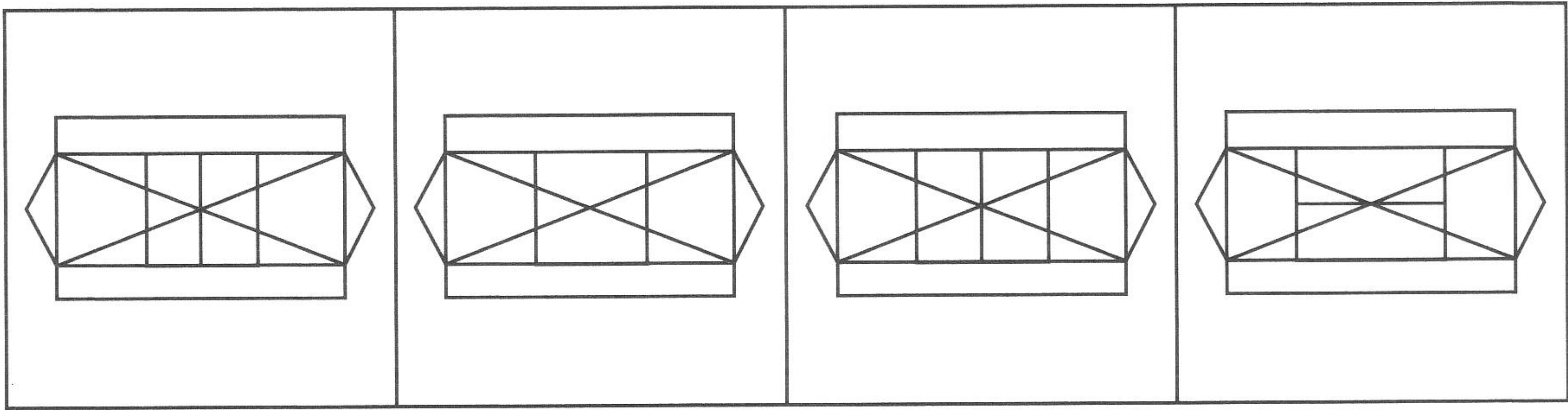
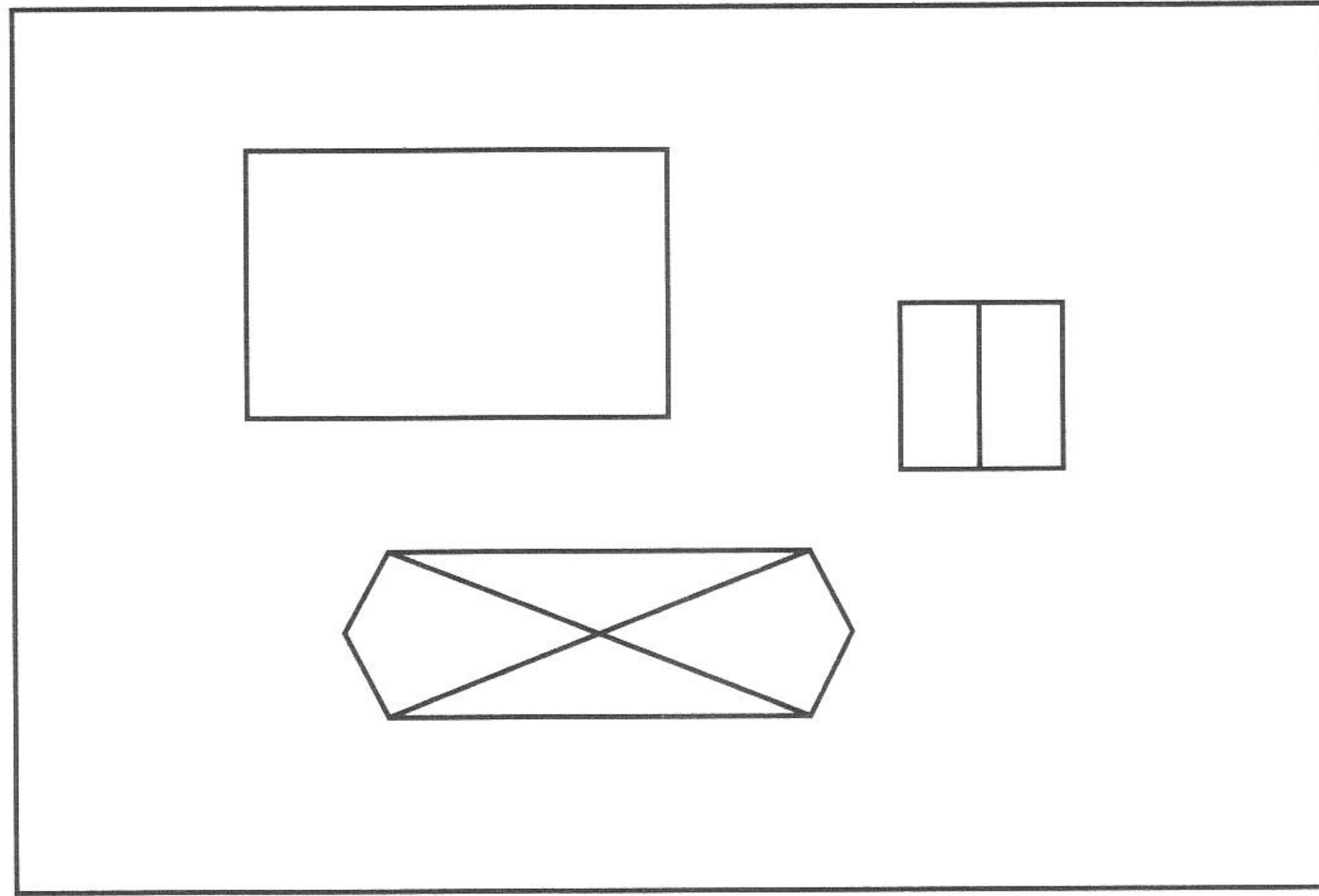

ก

ข

ค

ง

14

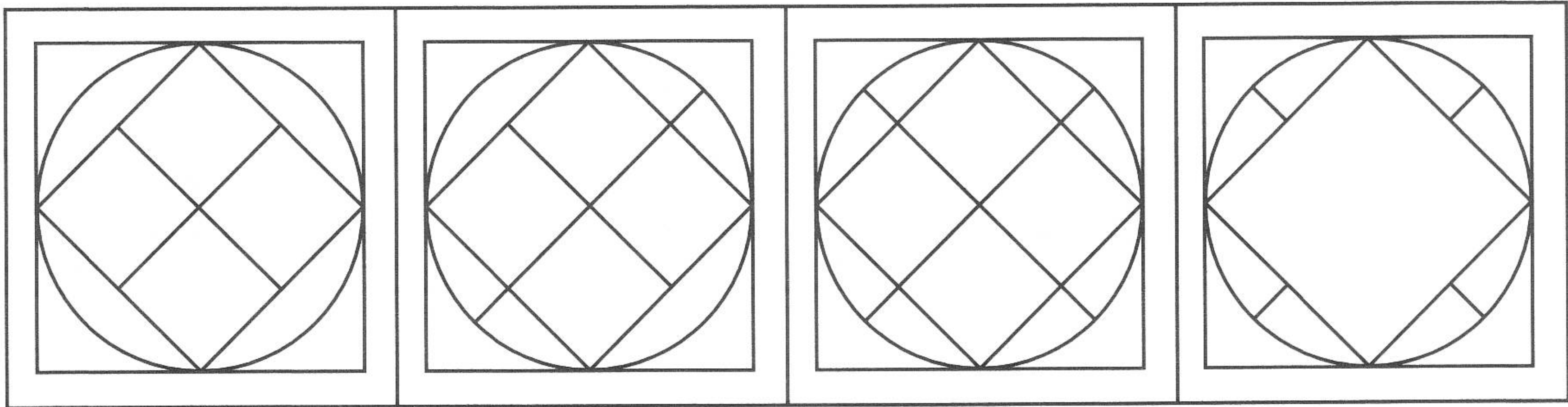
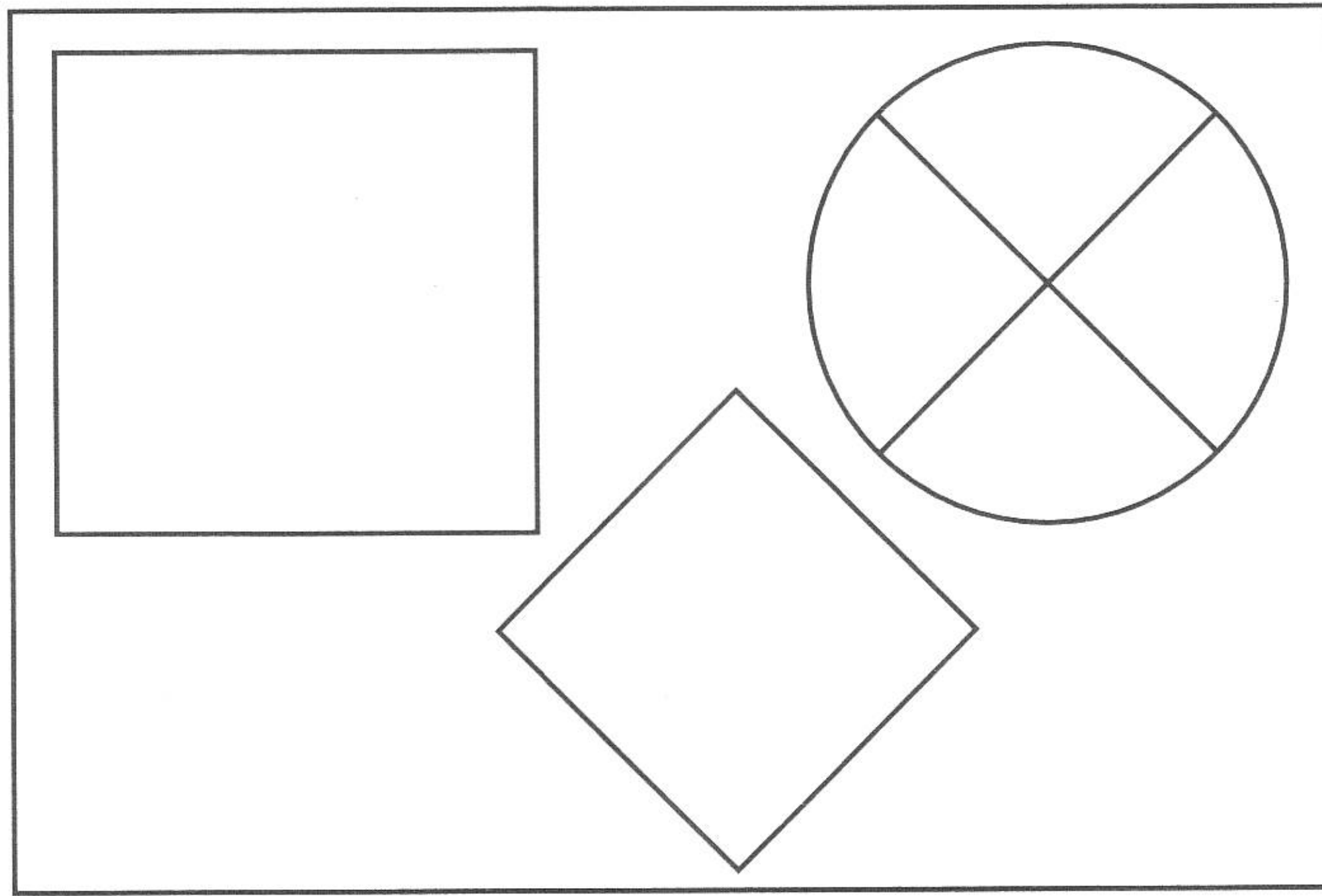

ก

ข

ค

ง

15

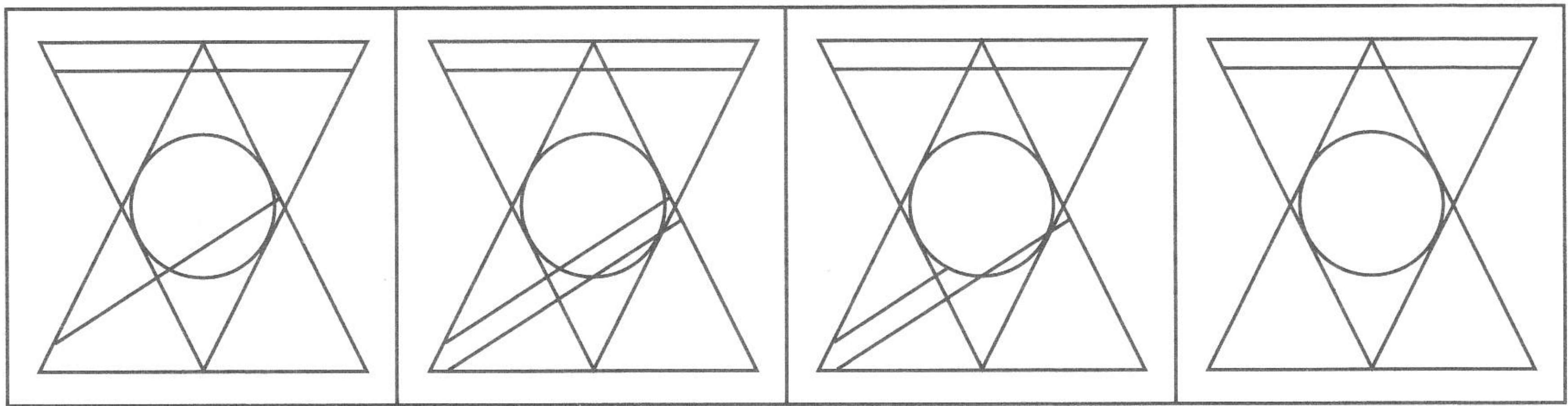
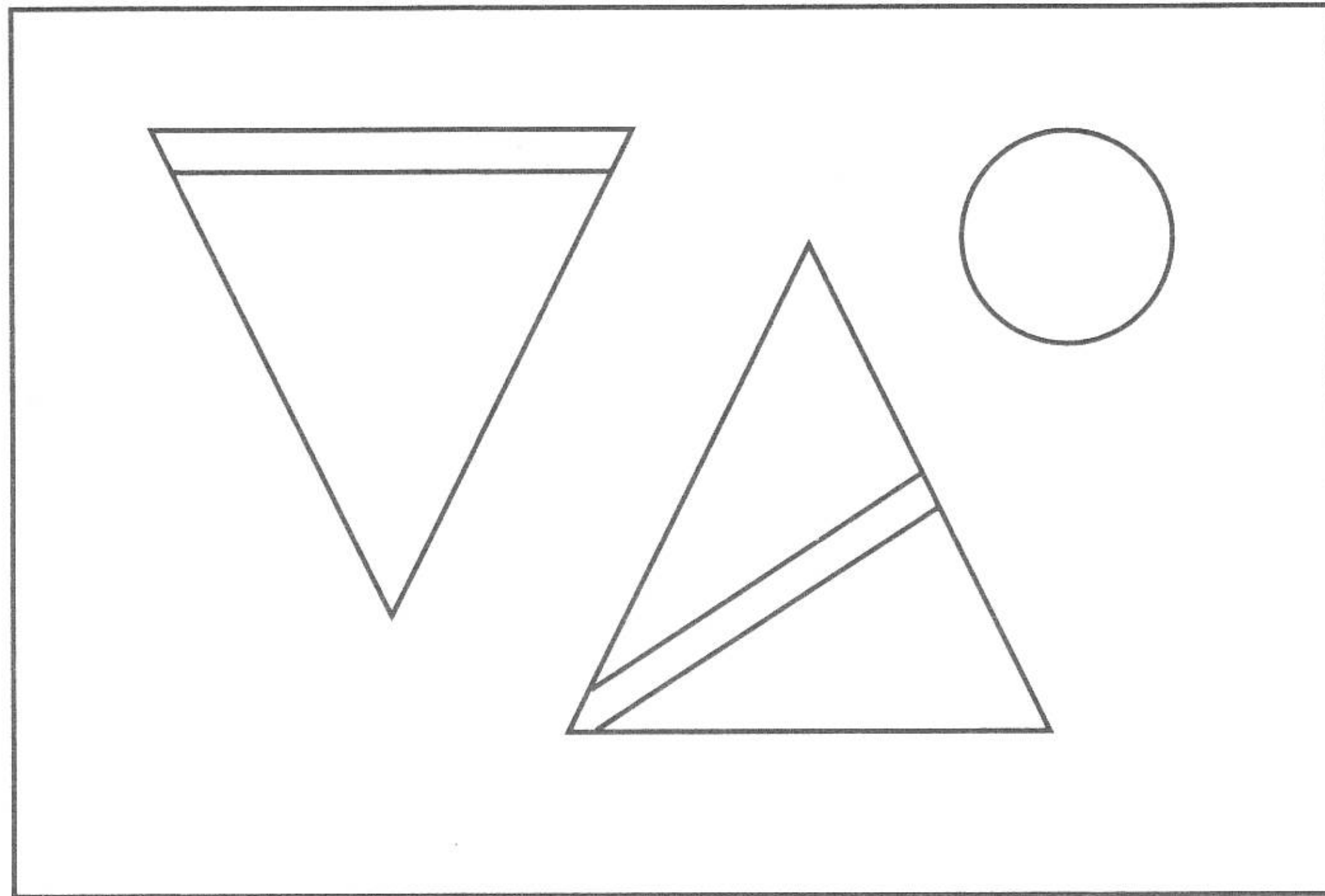

ก

ข

ค

ง

16

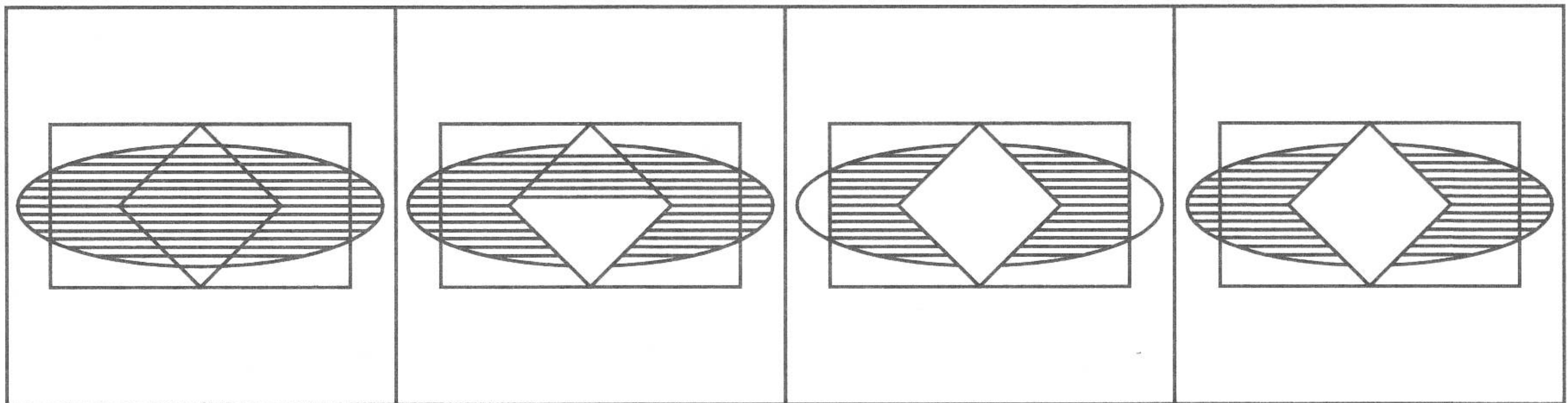
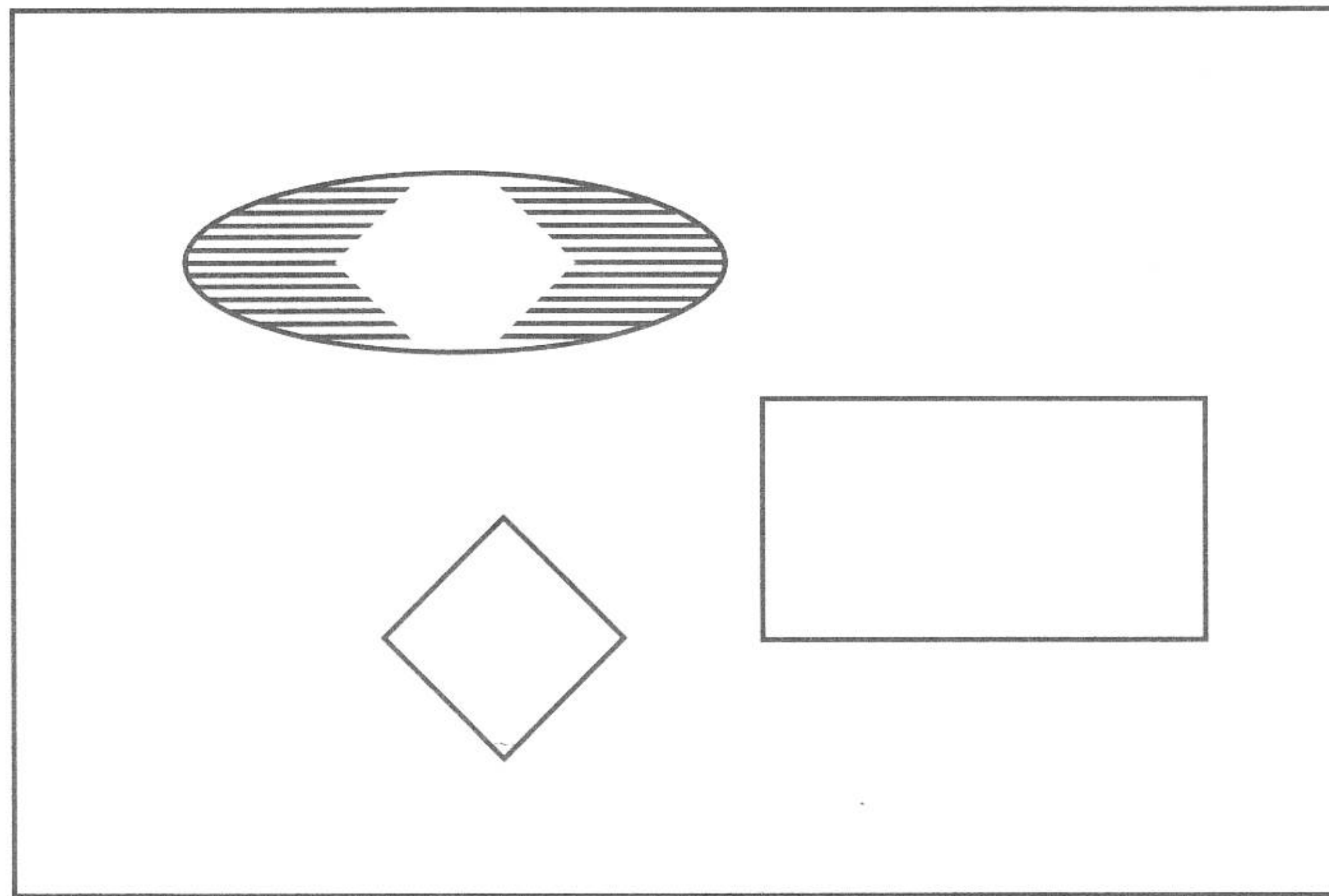

ก

ข

ค

ง

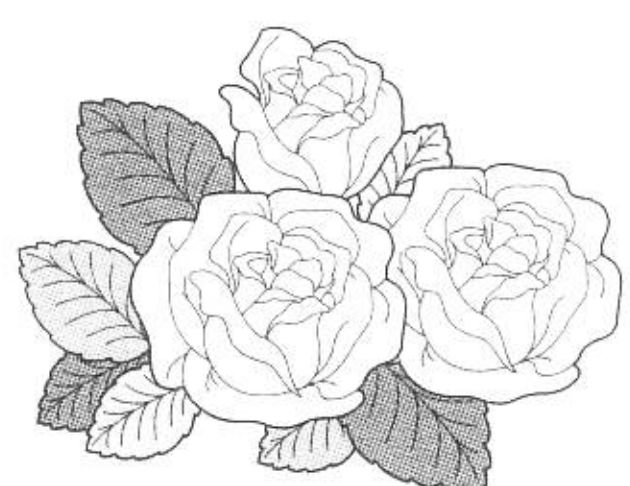

ตอนที่ 4

การวาดภาพ ตามแบบที่กำหนด

- ◇ การวาดภาพตามแบบที่กำหนด 8 ข้อ
- ◇ การลากเส้นต่อจุดให้เหมือนภาพที่กำหนด 12 ข้อ

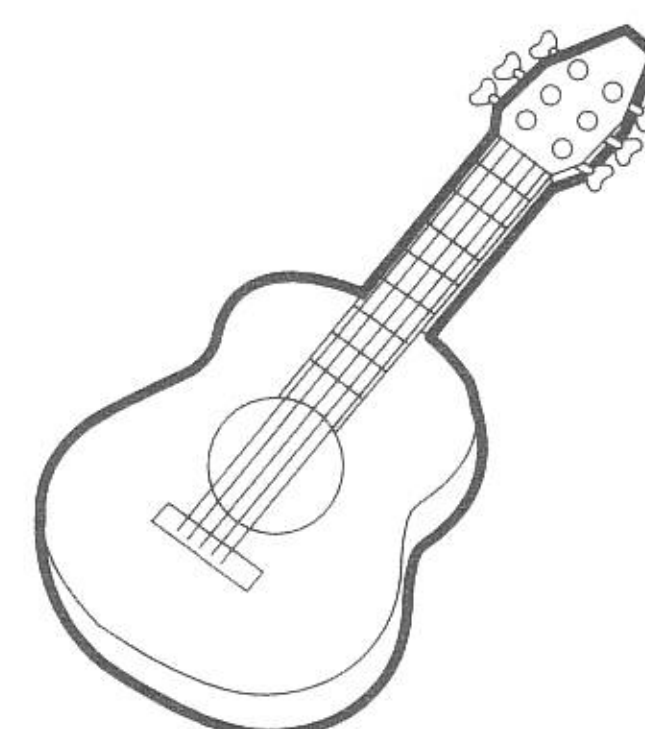

จงวาดภาพตามแบบที่กำหนดให้

1

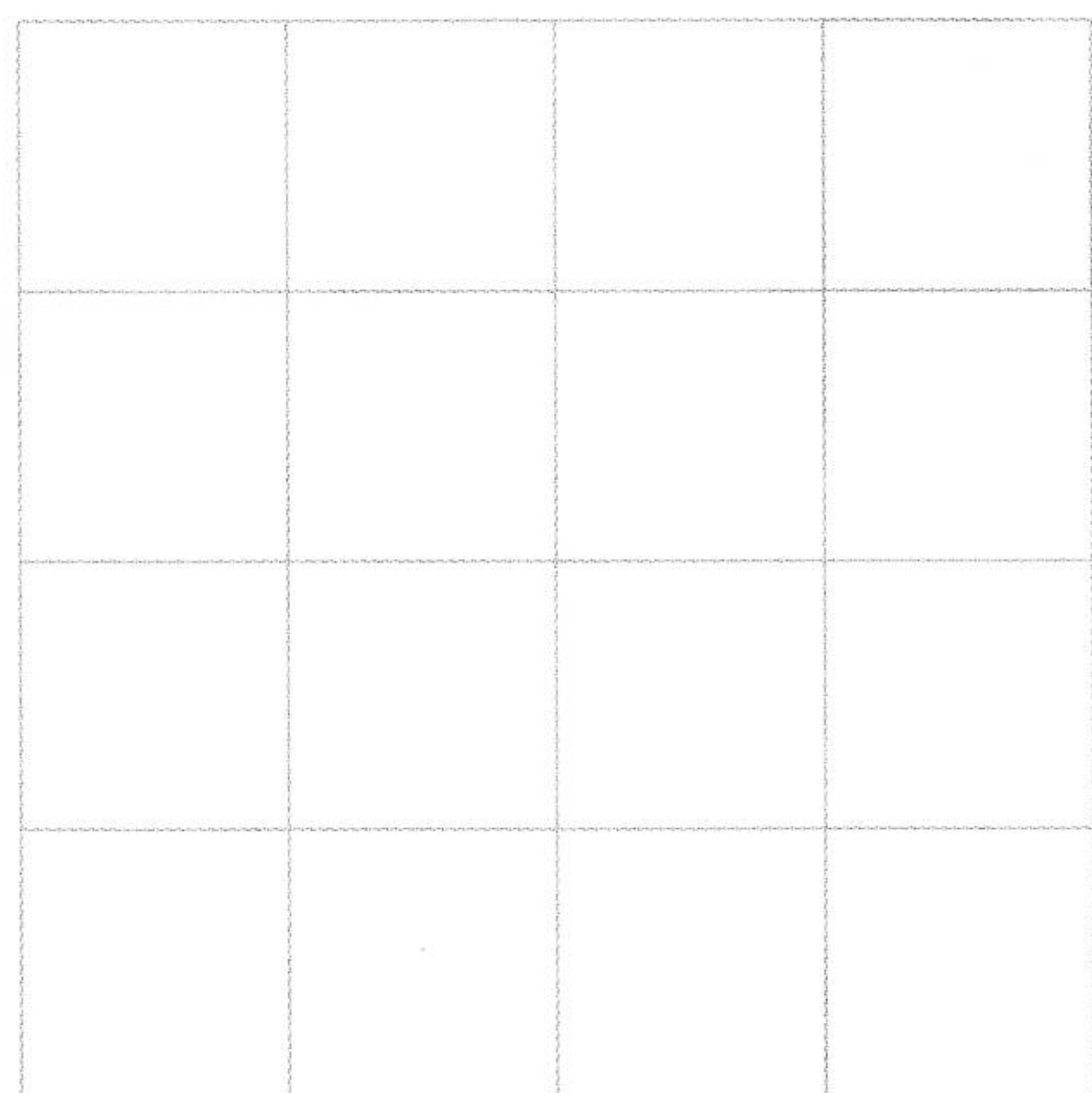
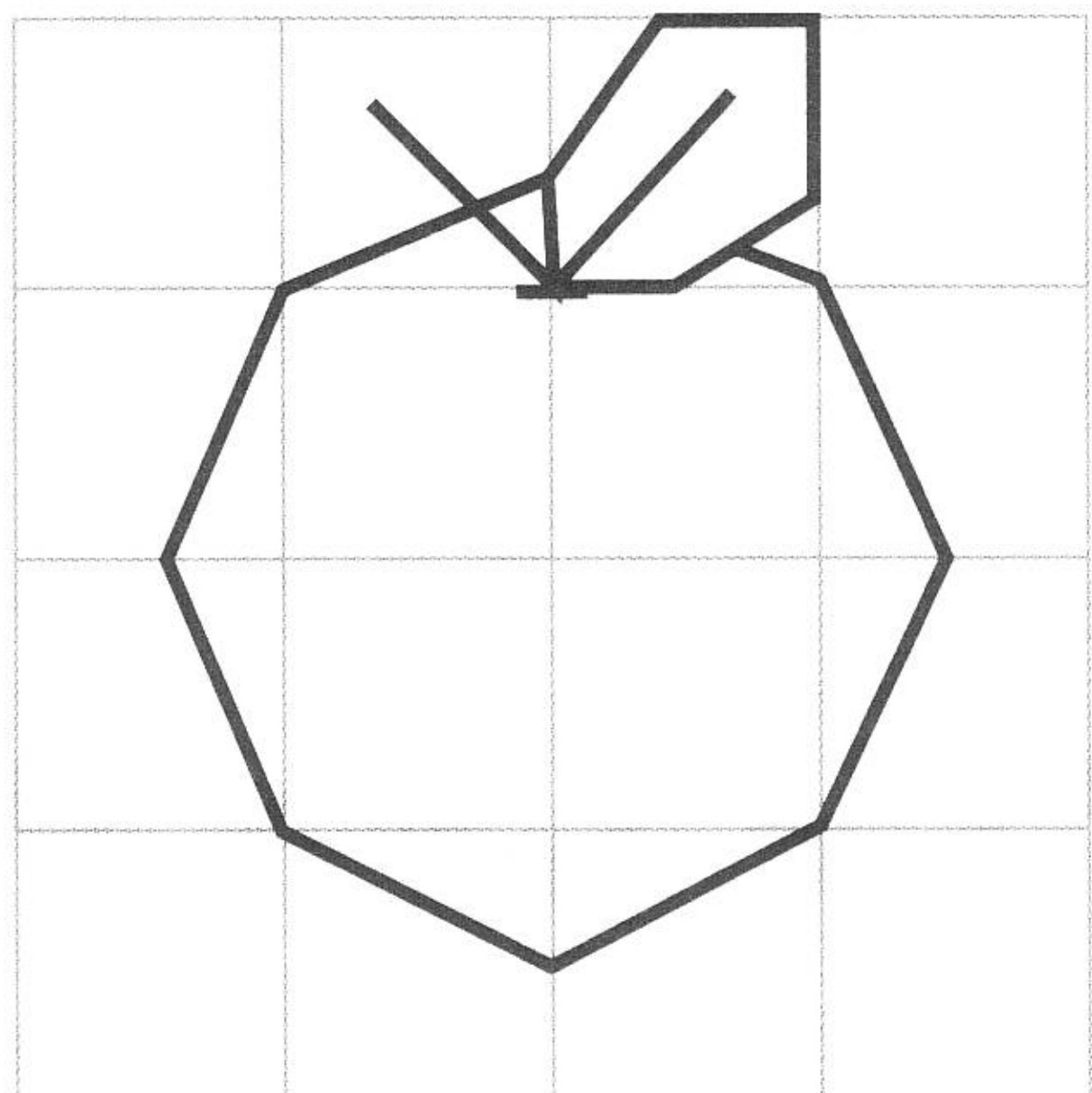

2

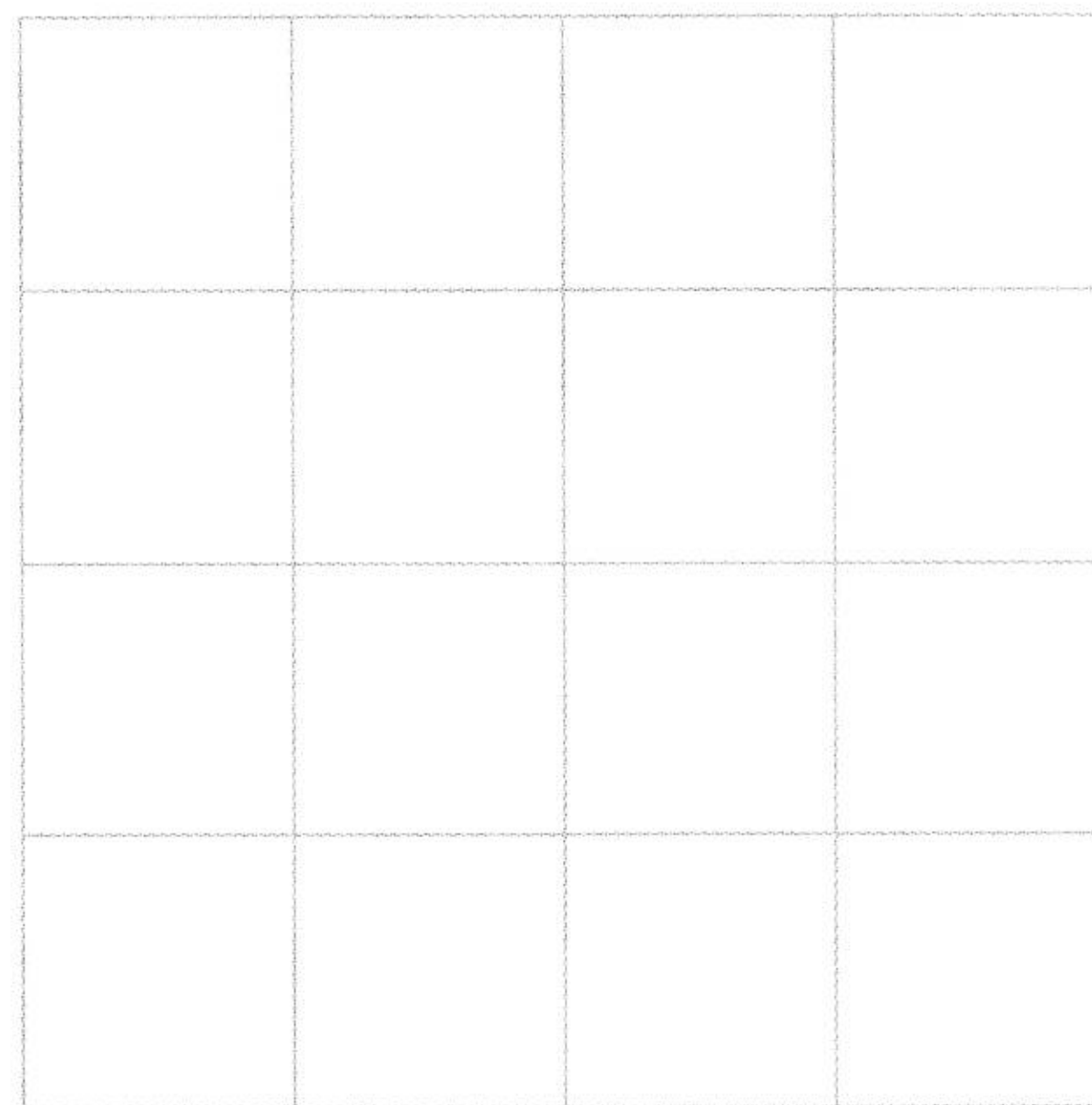
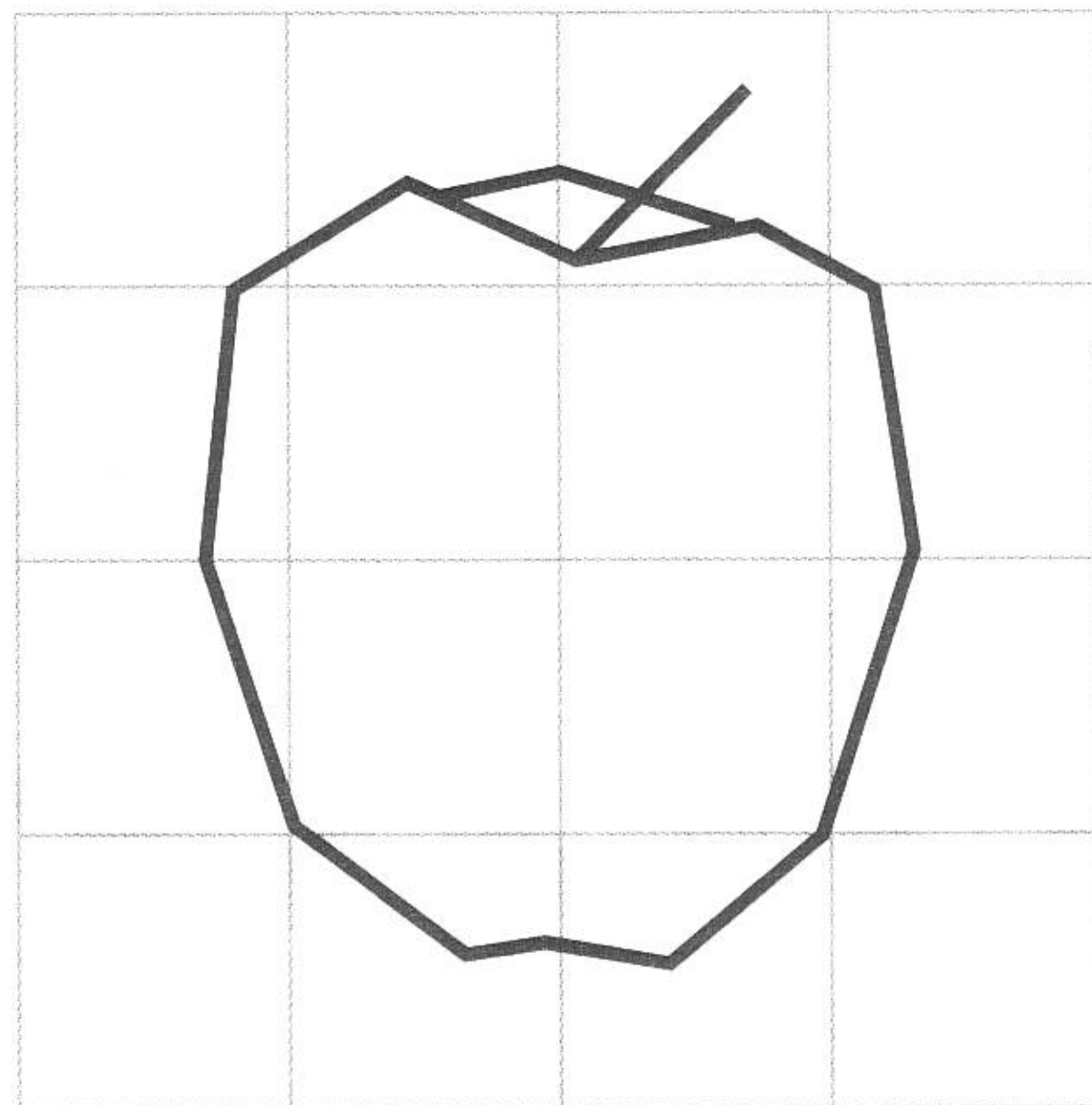

3

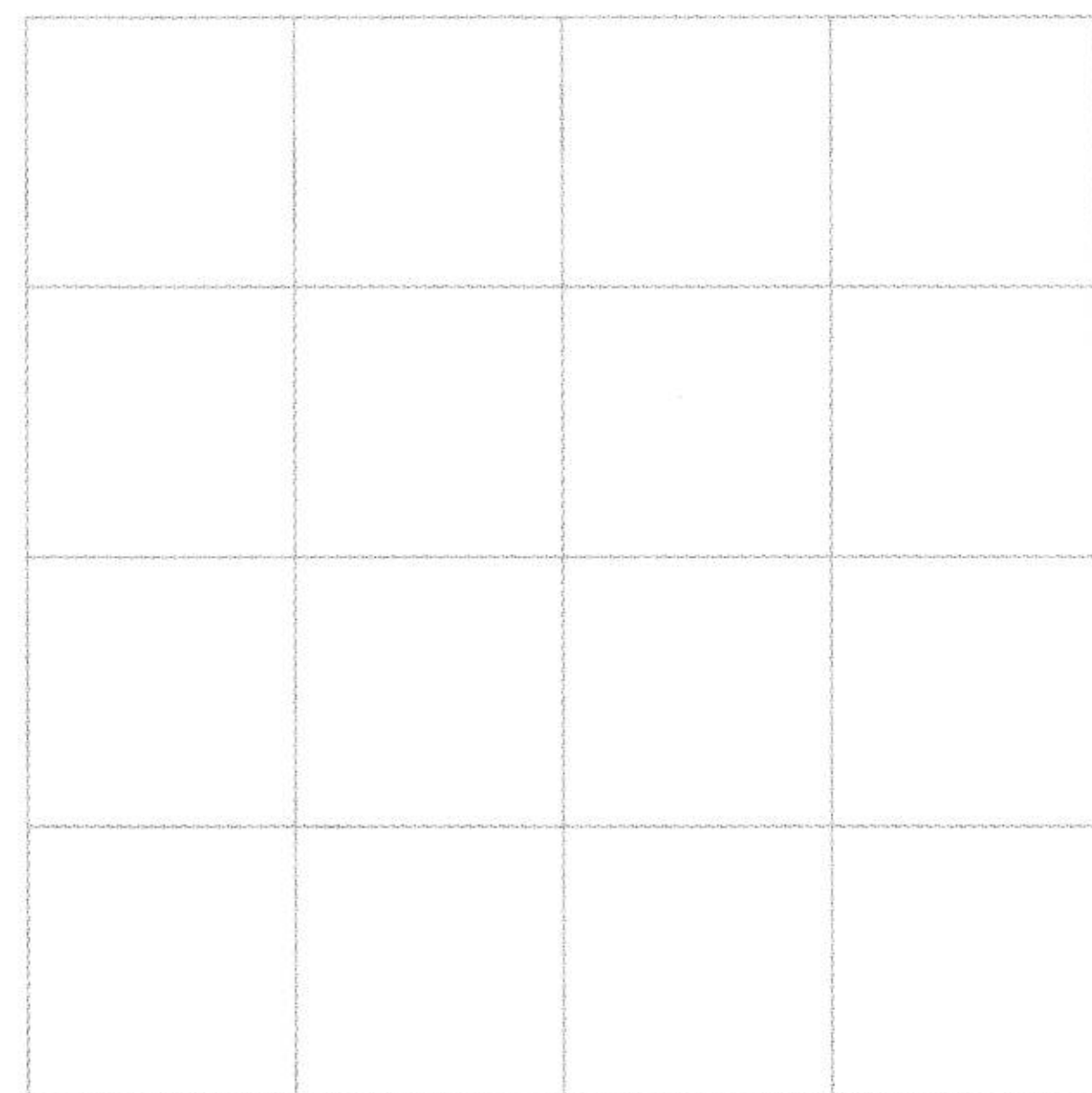
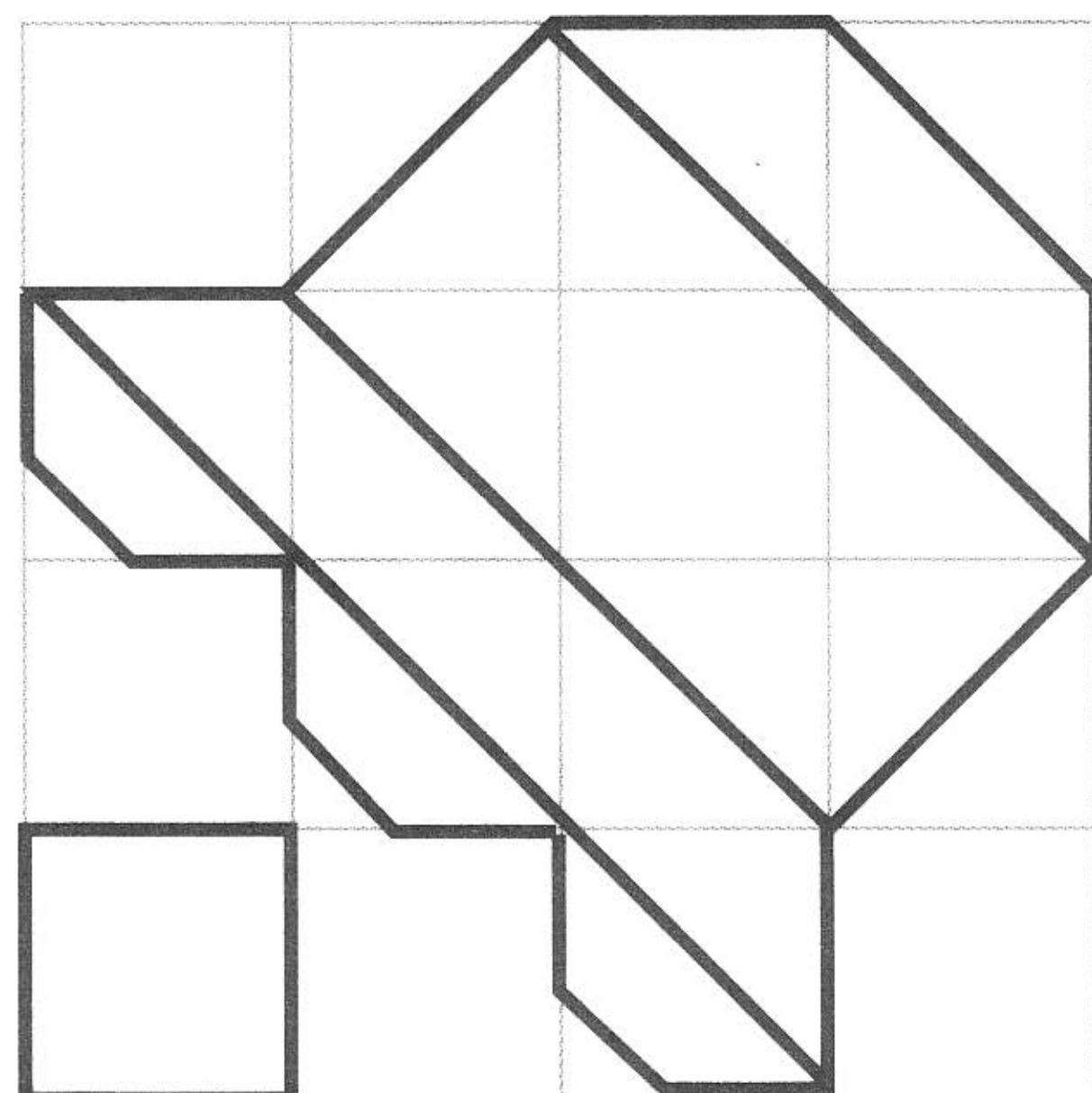

4

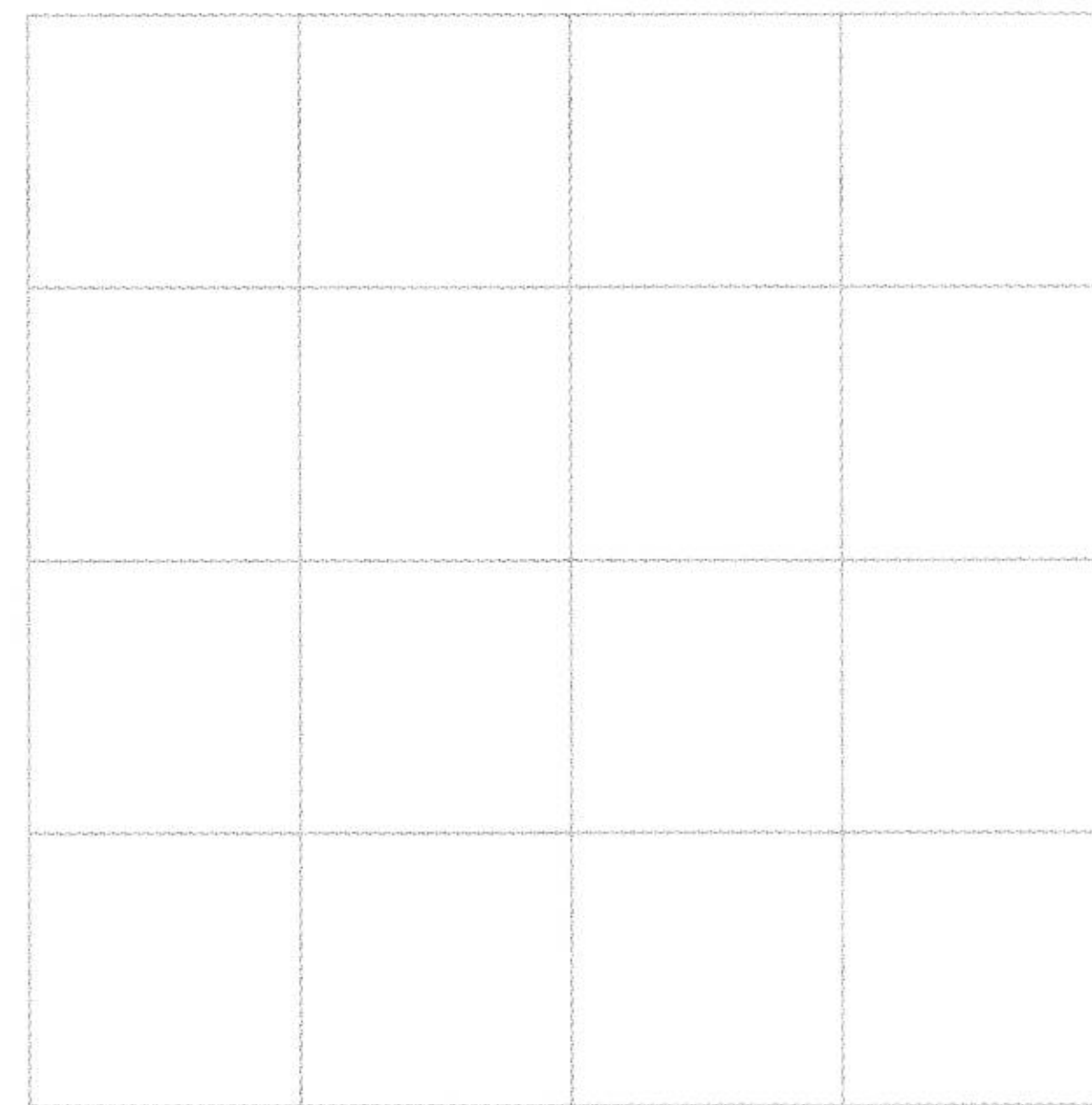
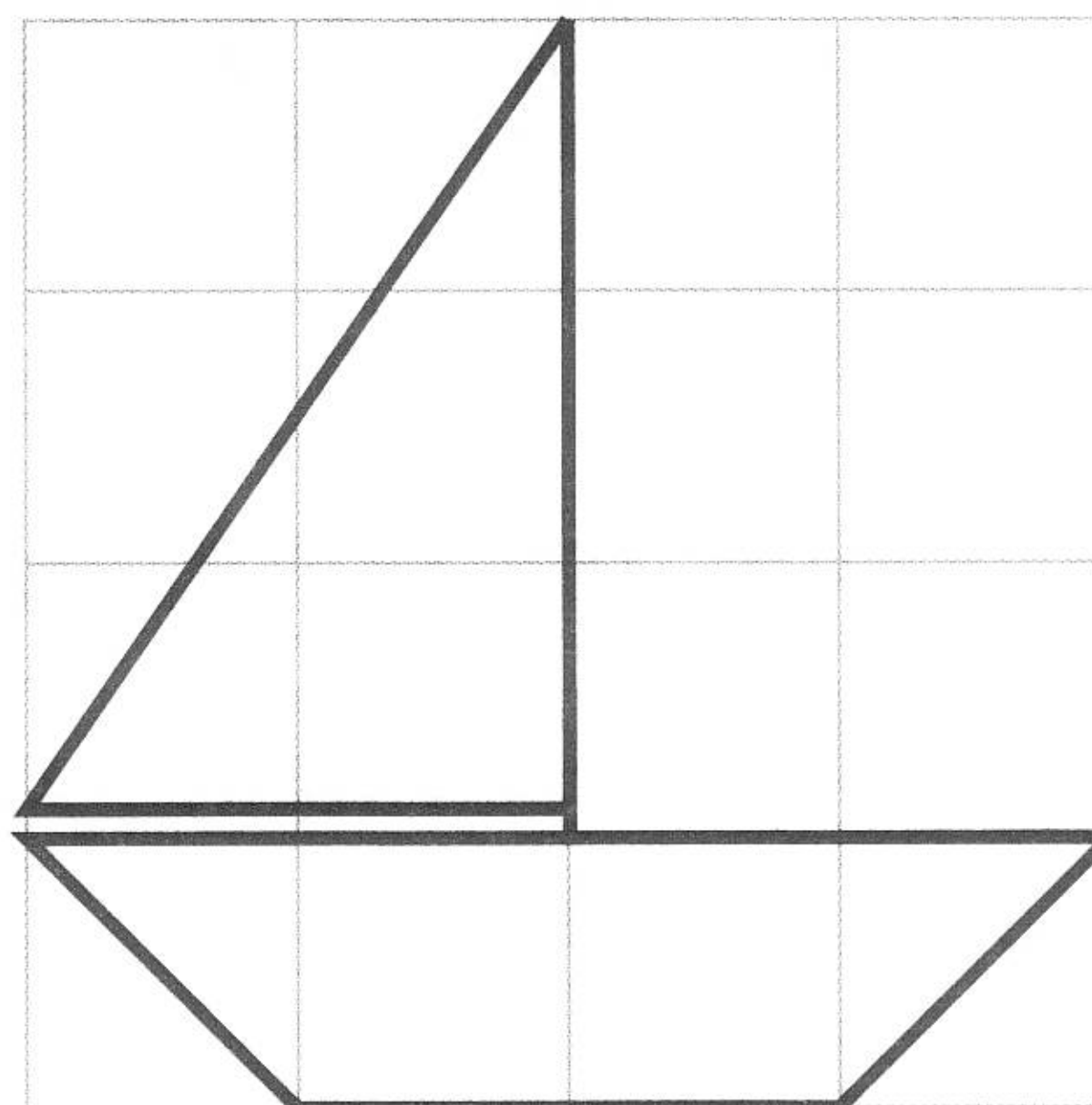

5

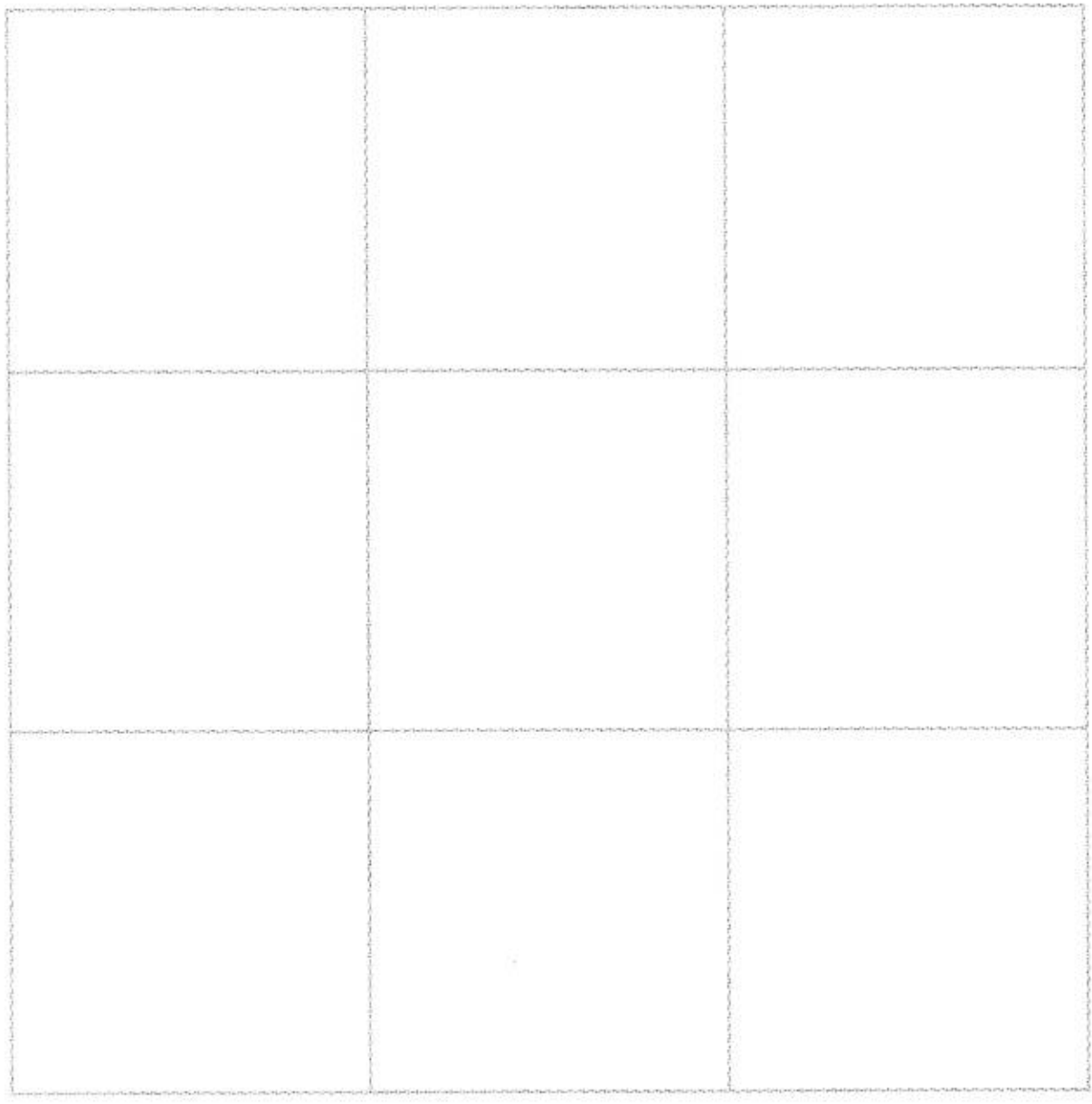
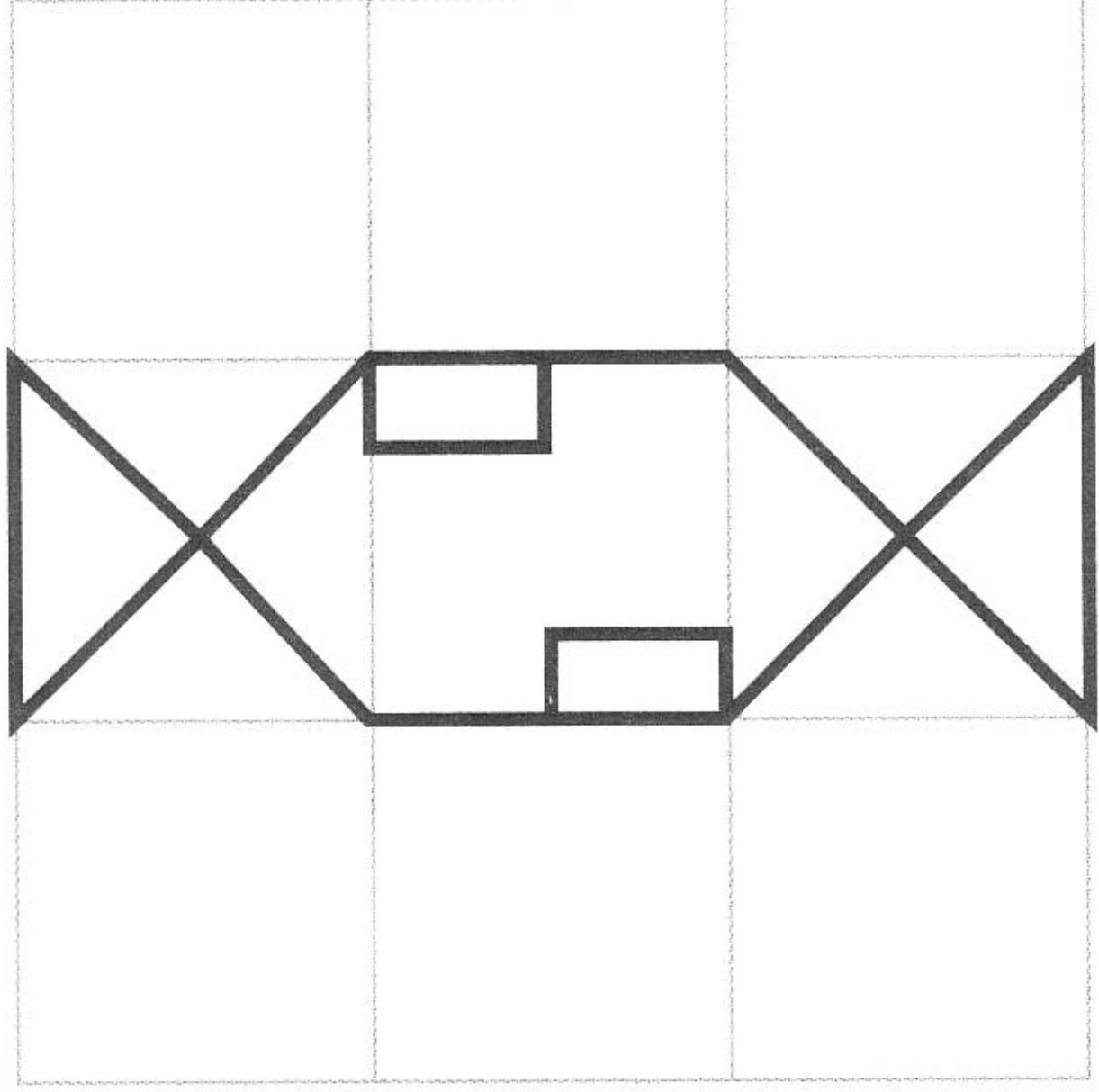

6

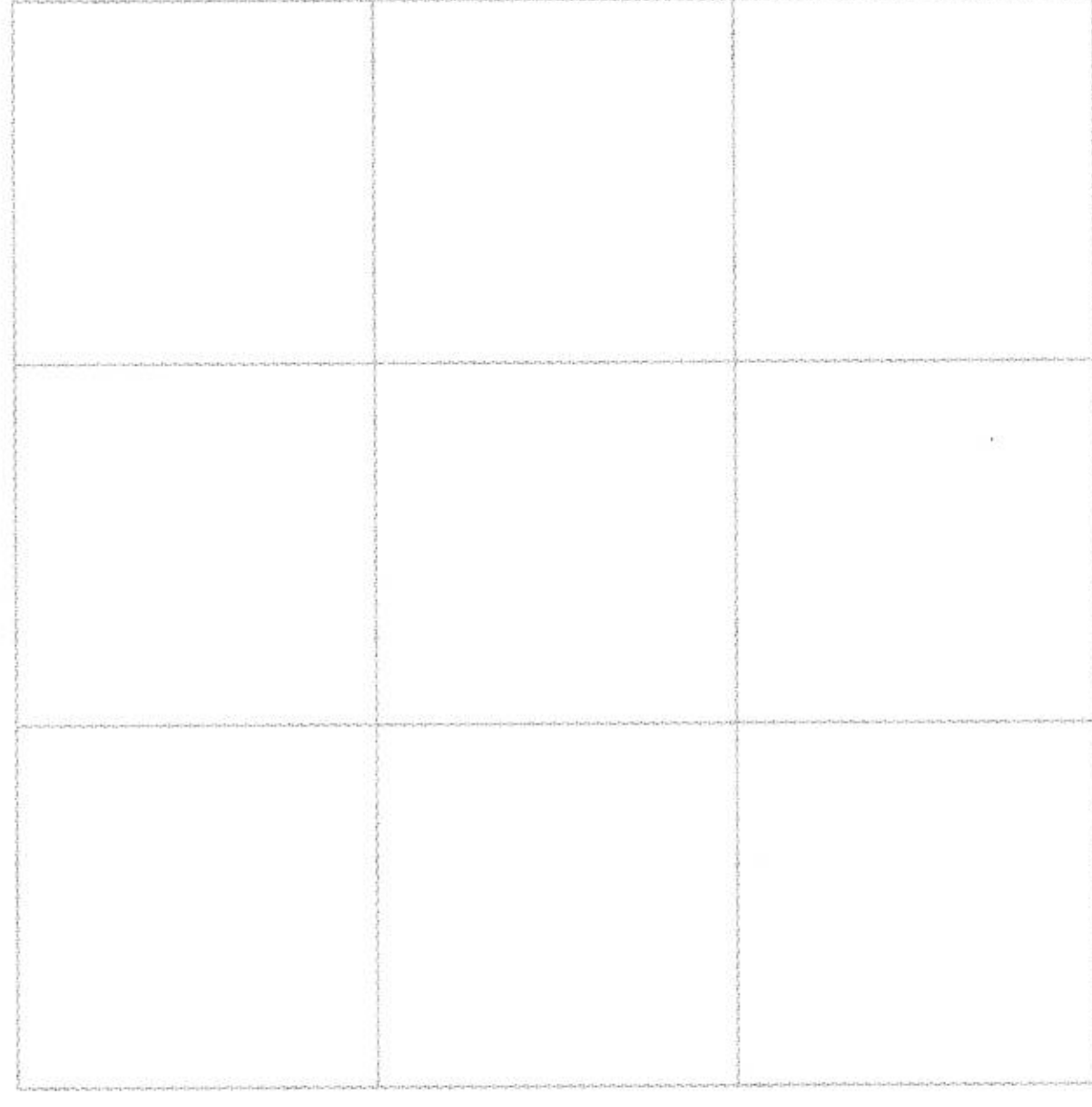
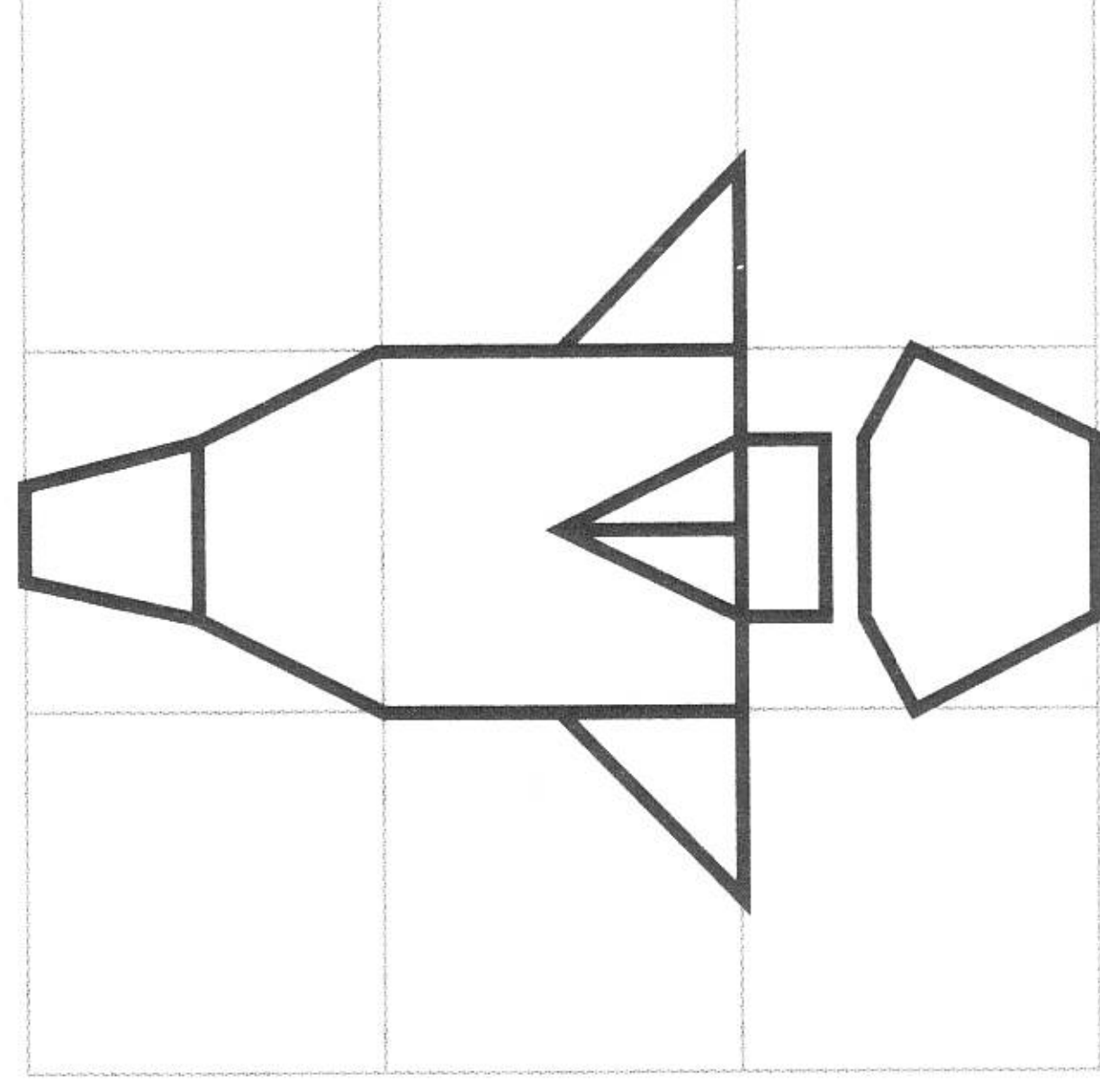

7

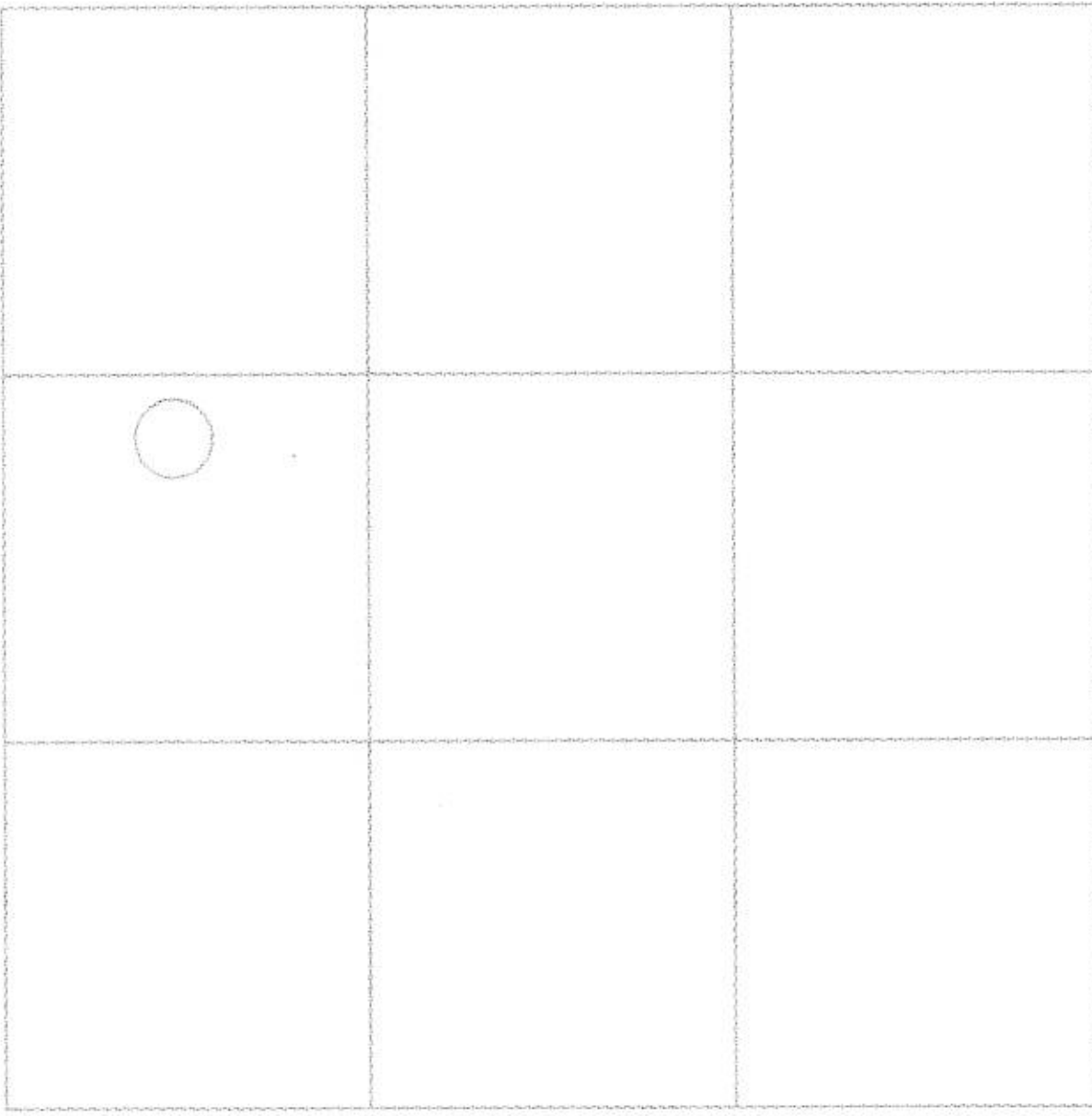
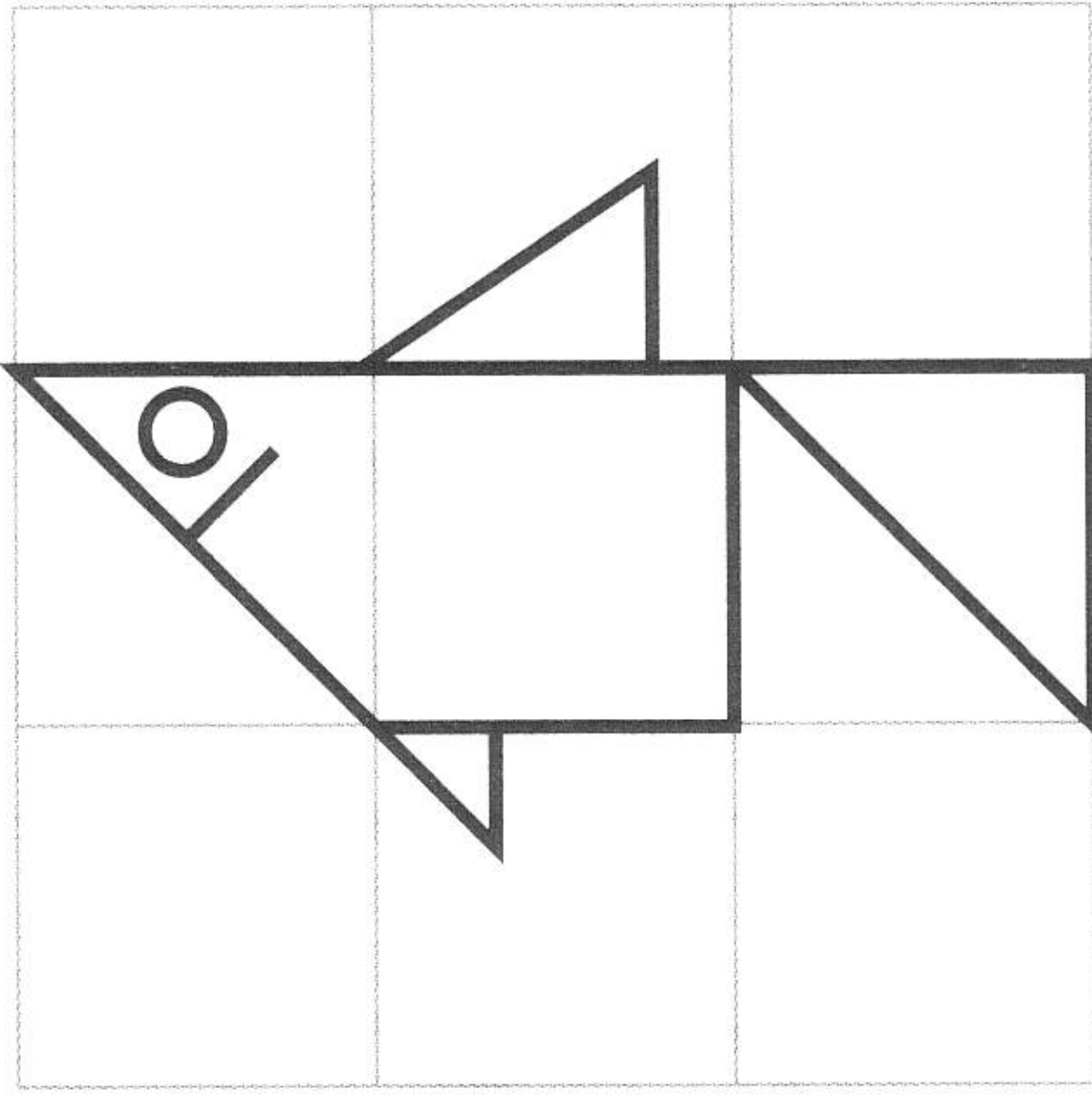

8

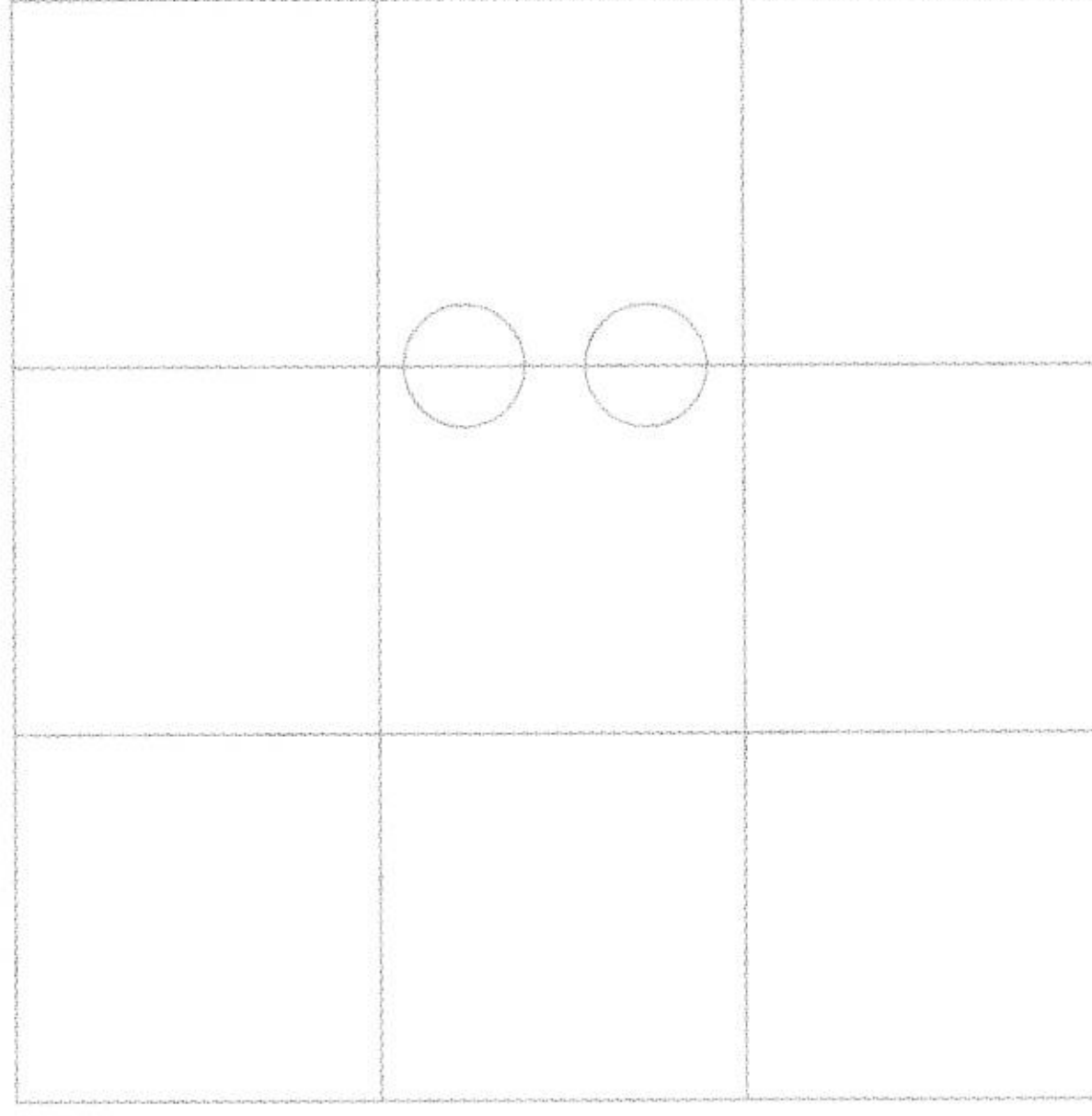
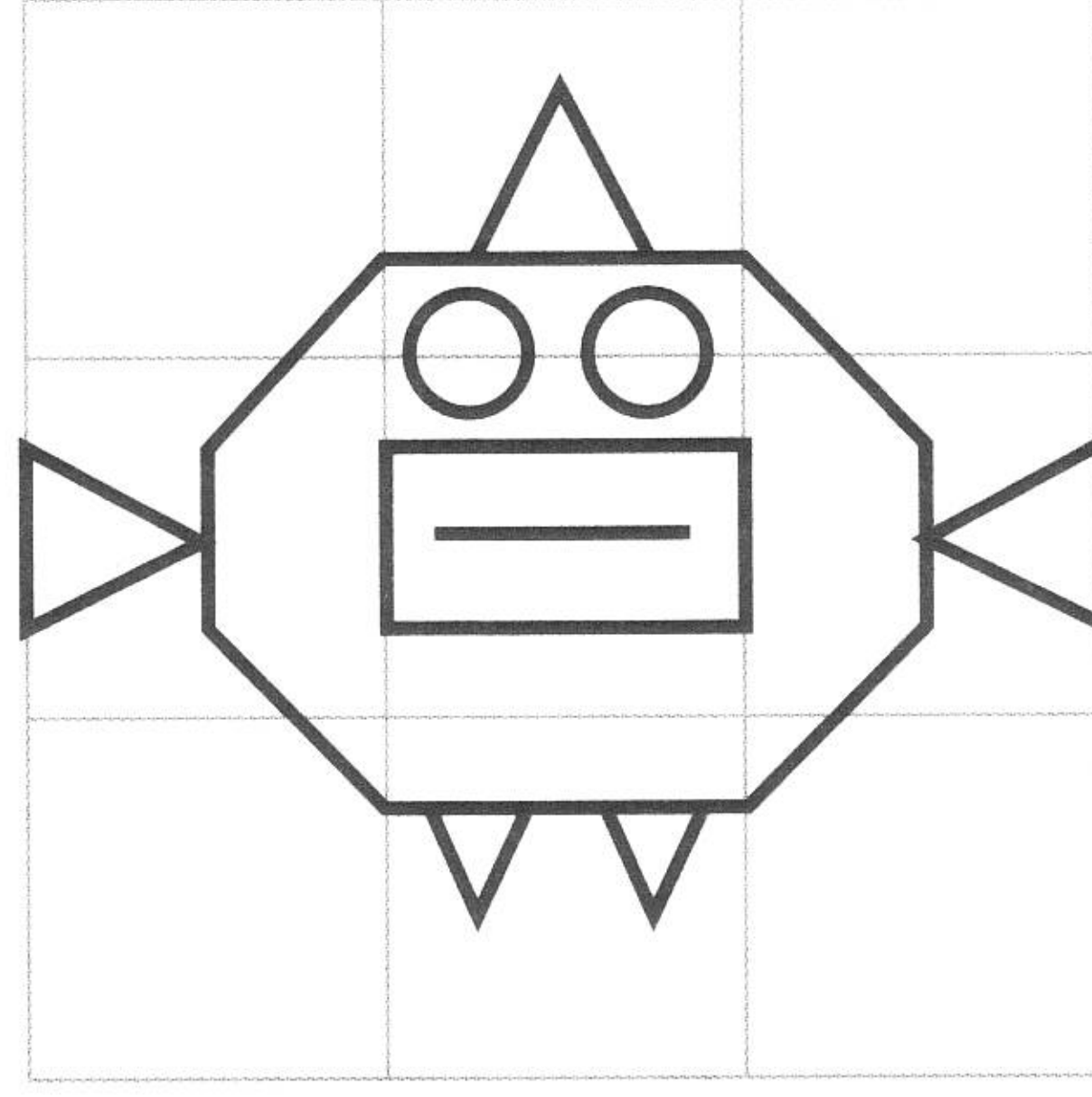

จงลากเส้นต่อจุดให้เหมือนภาพตัวอย่าง

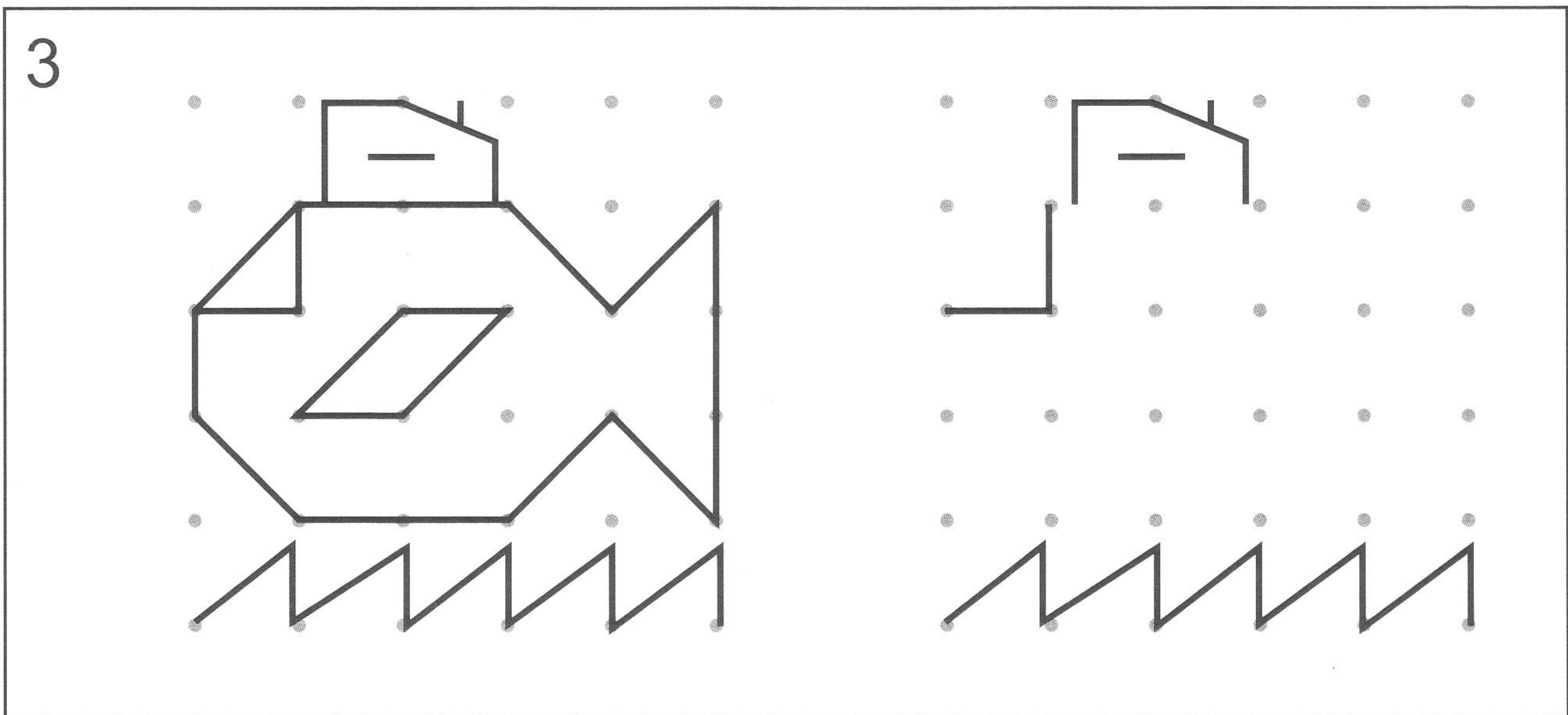
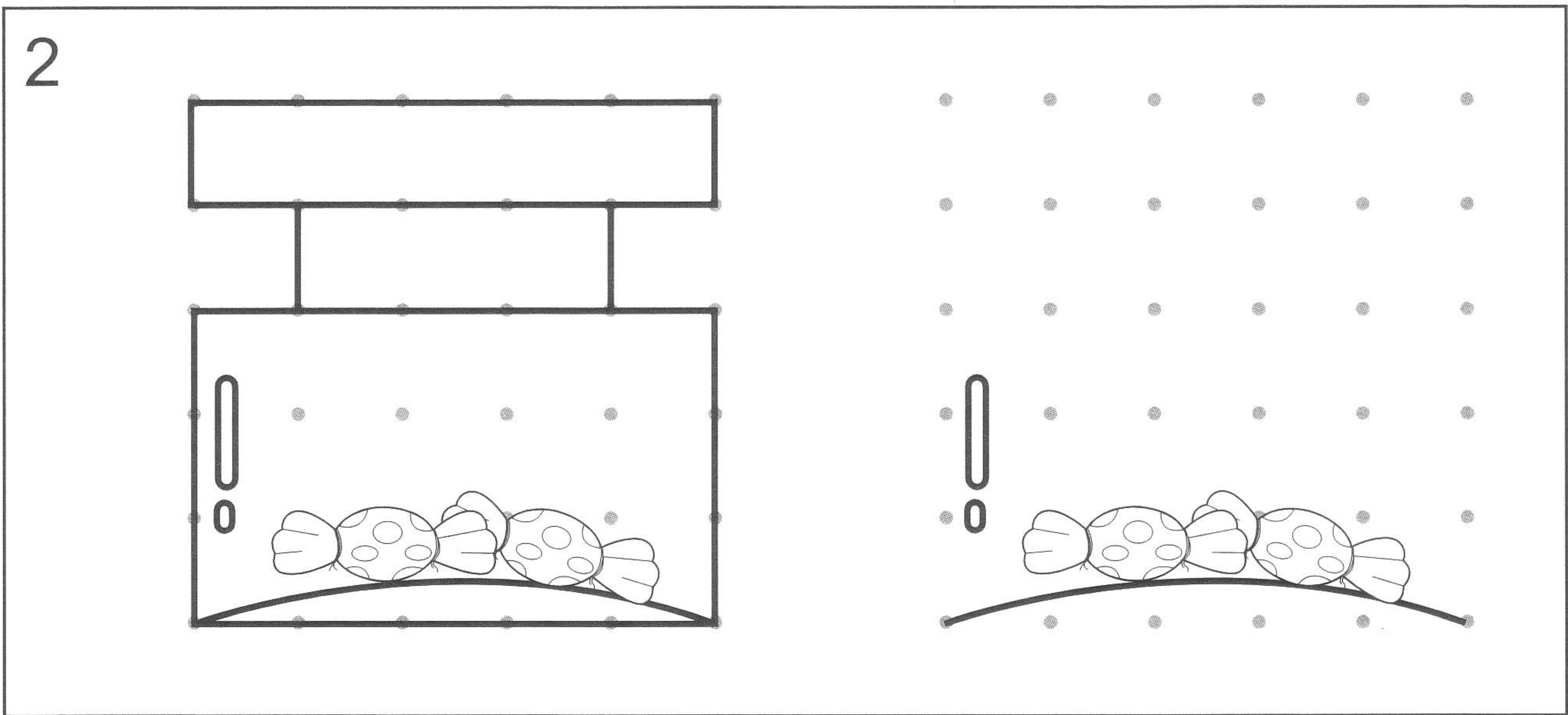
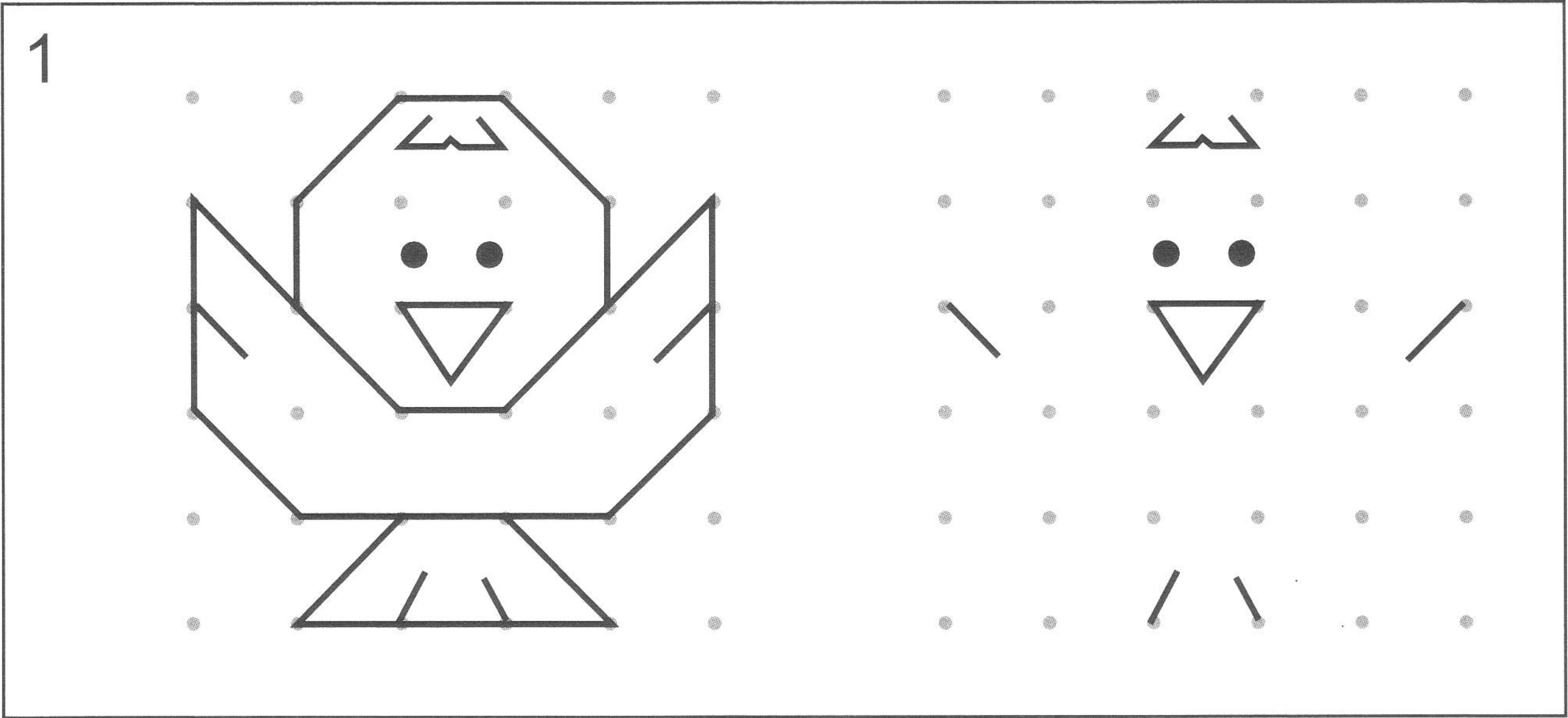

4

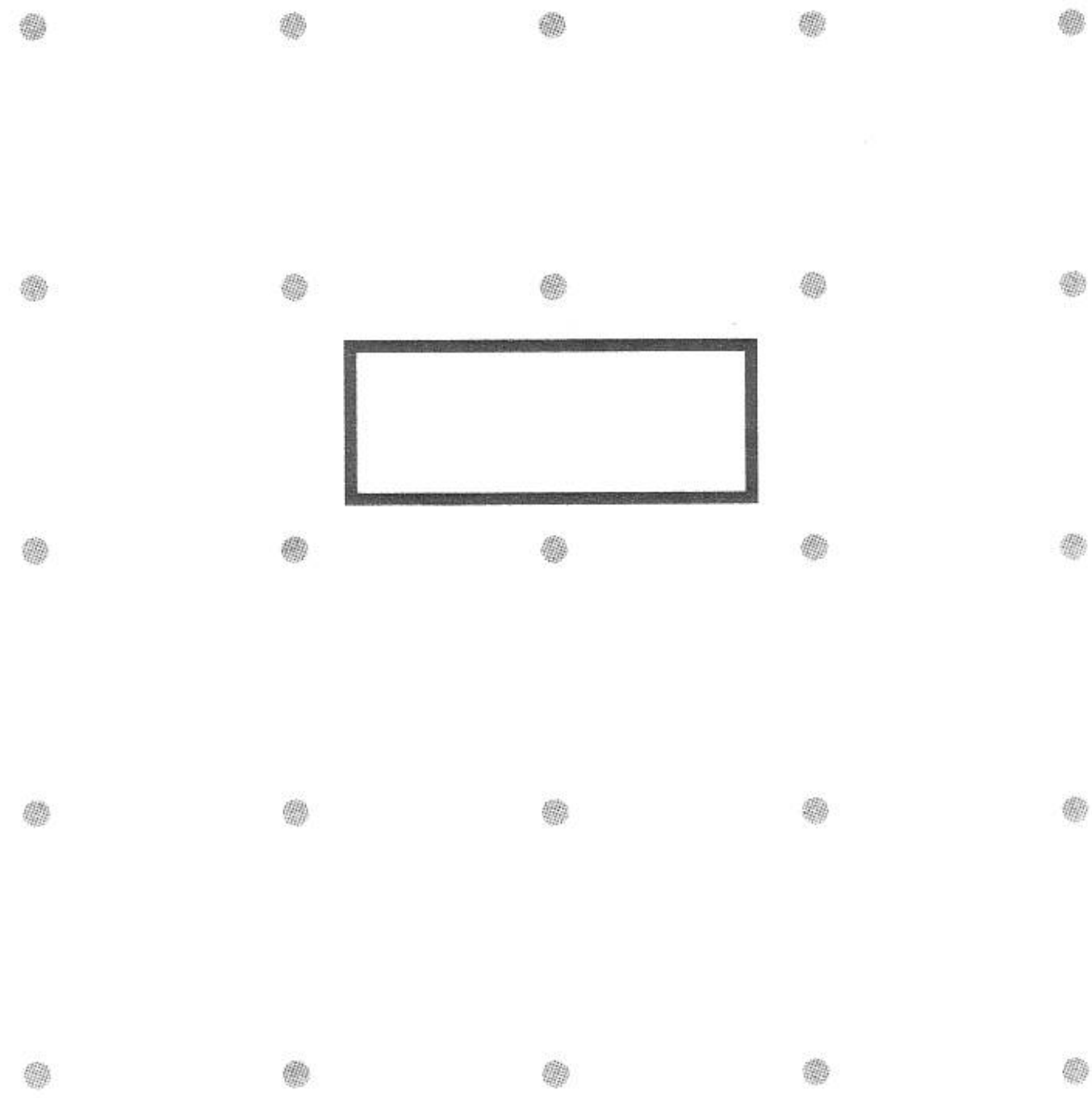
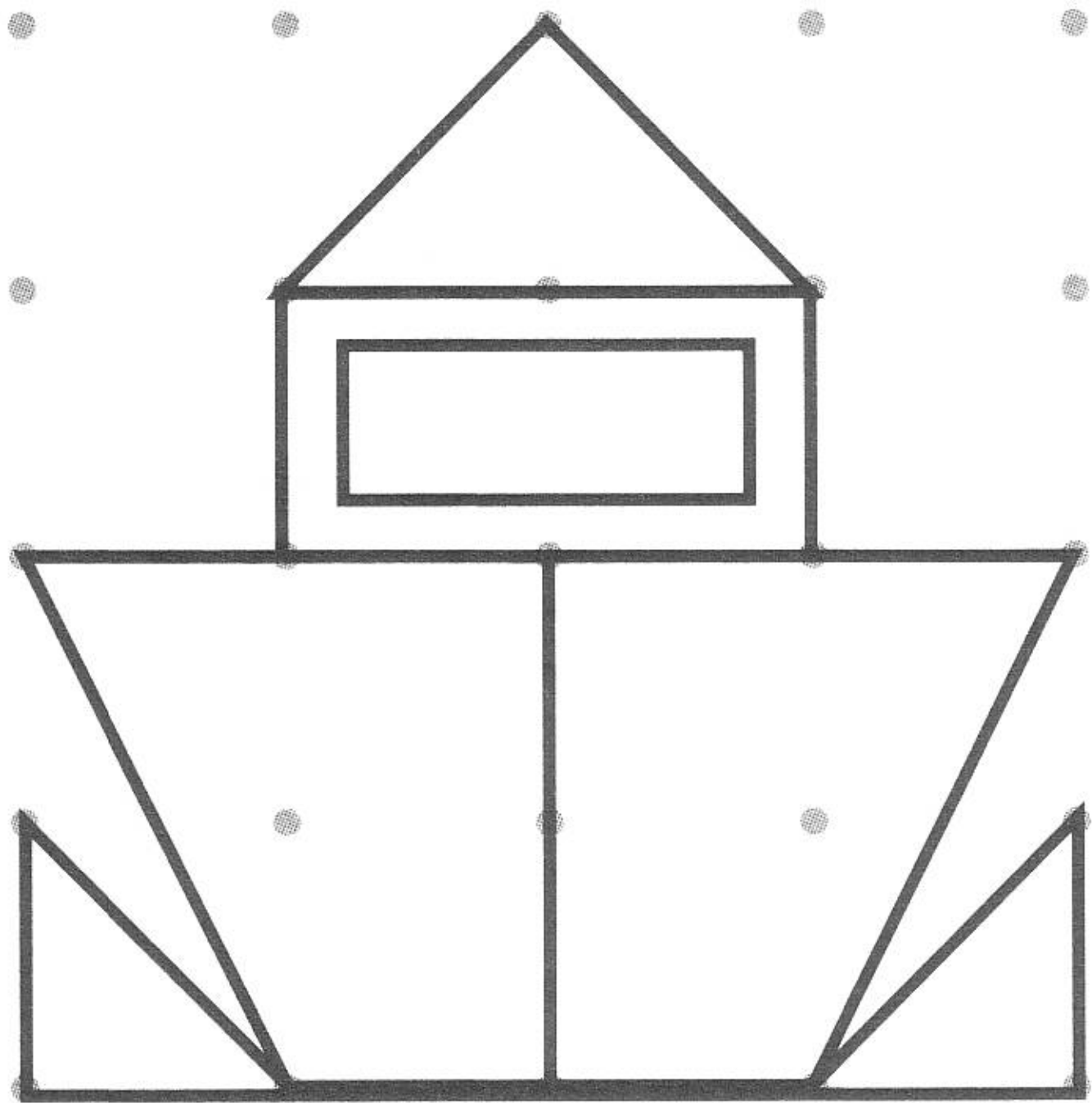

5

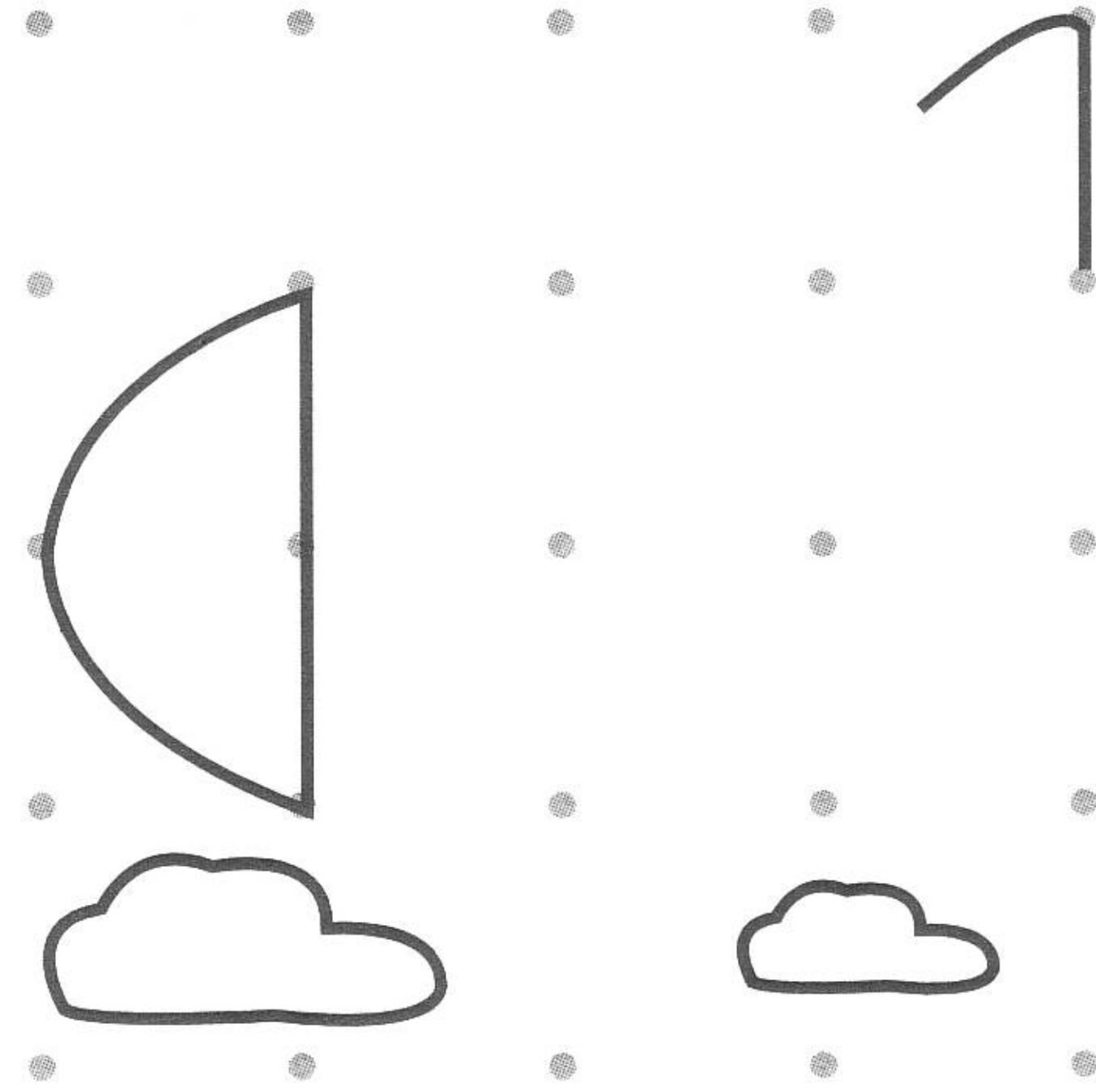

6

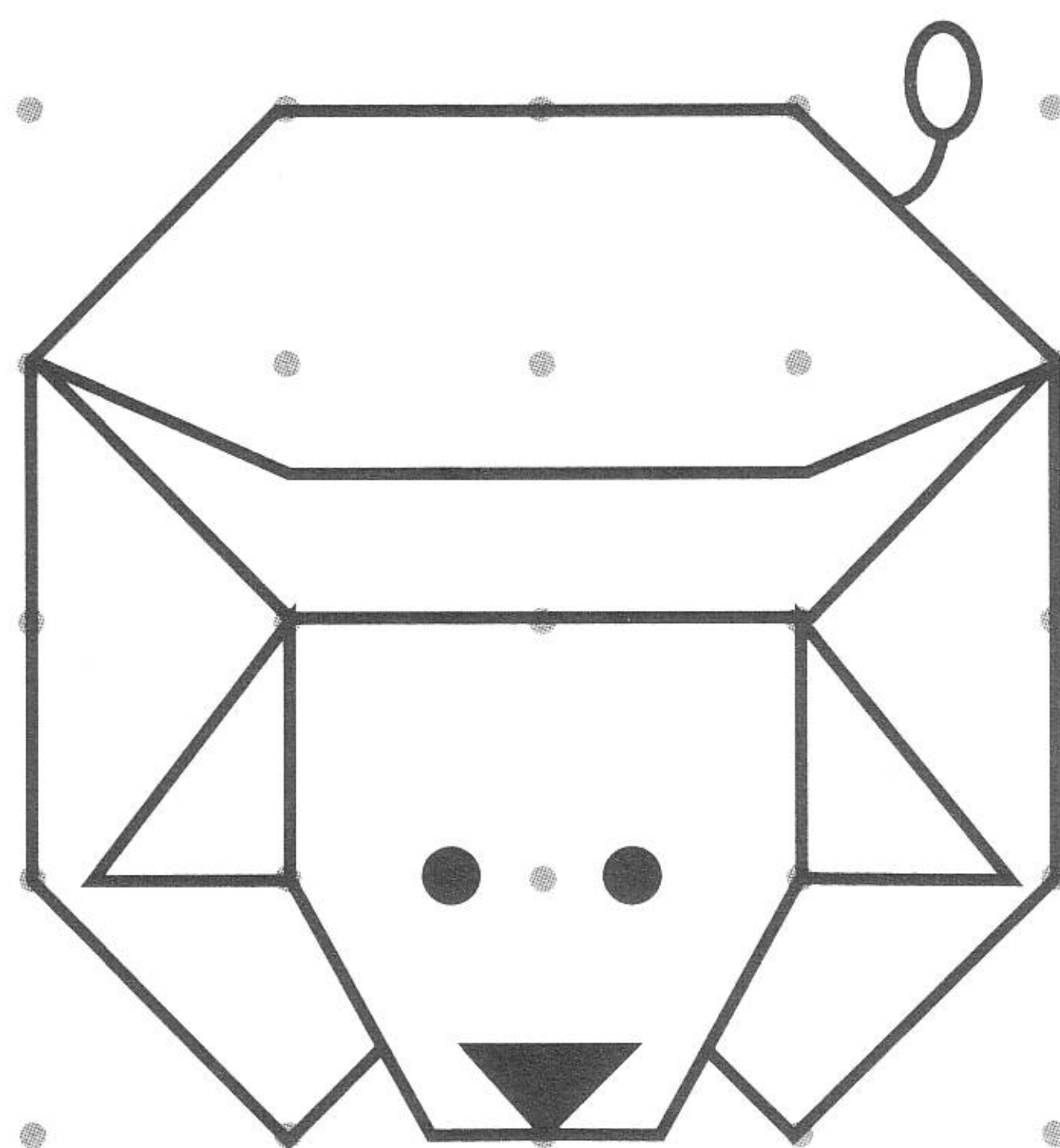

7

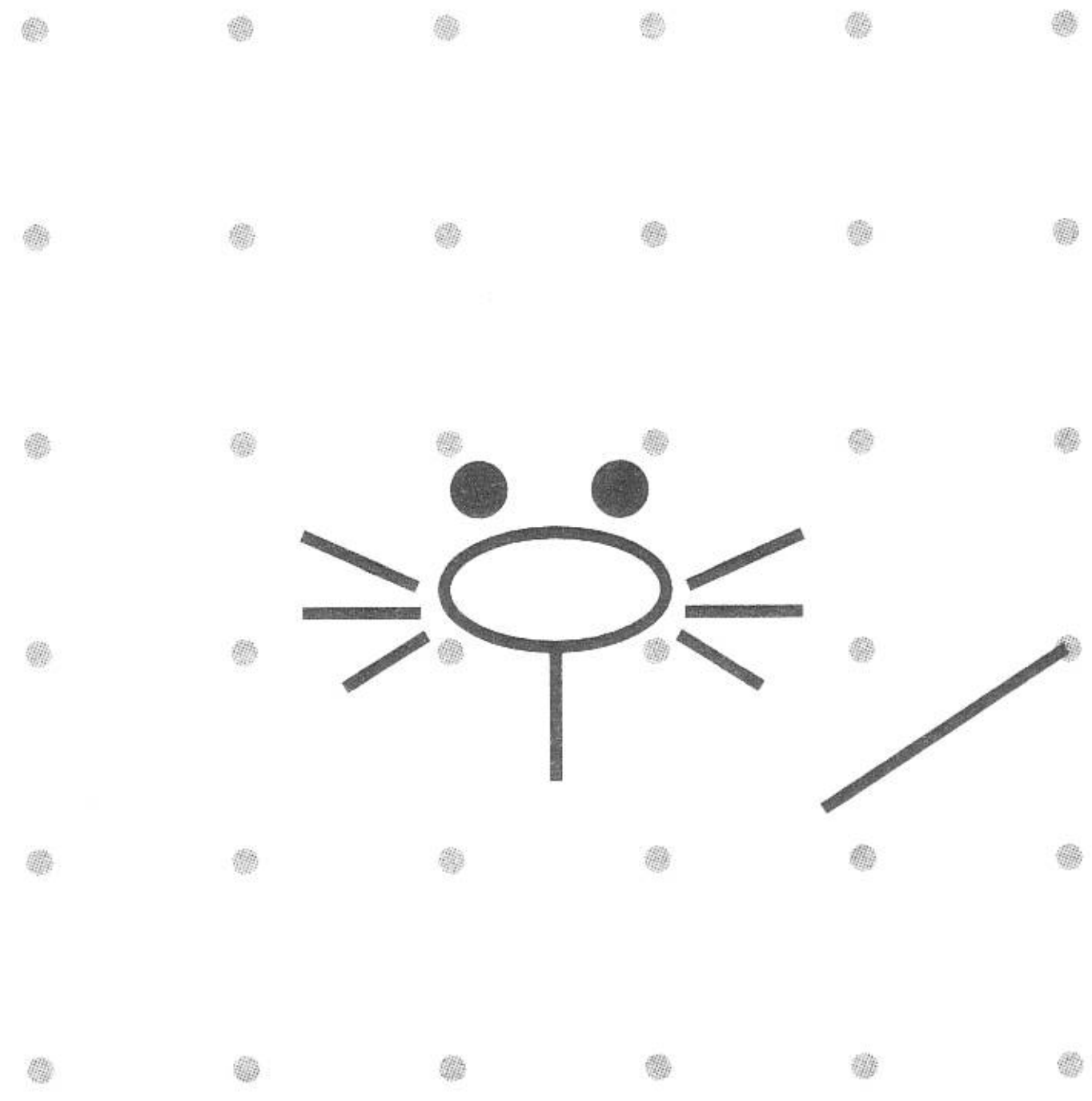
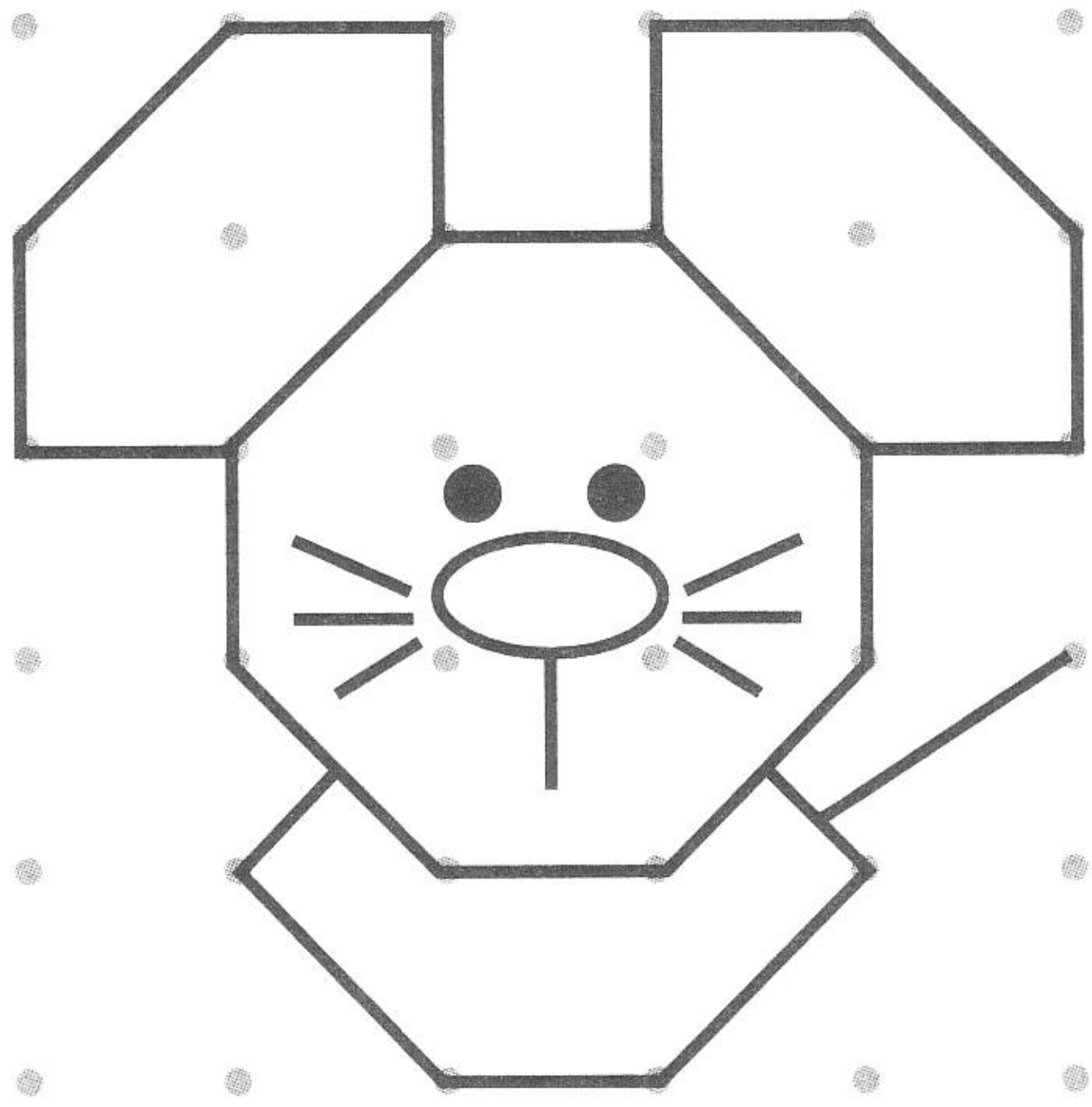

8

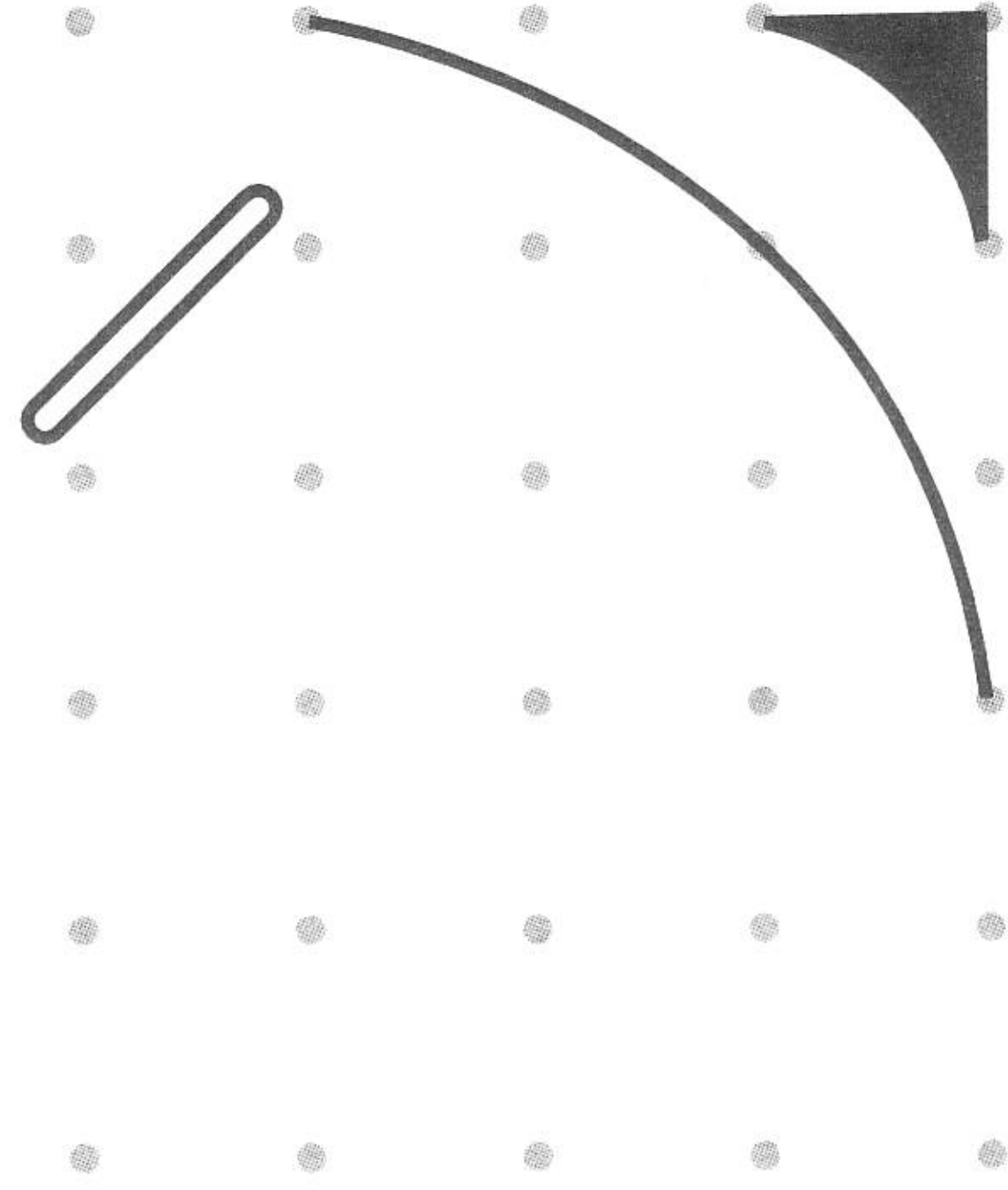
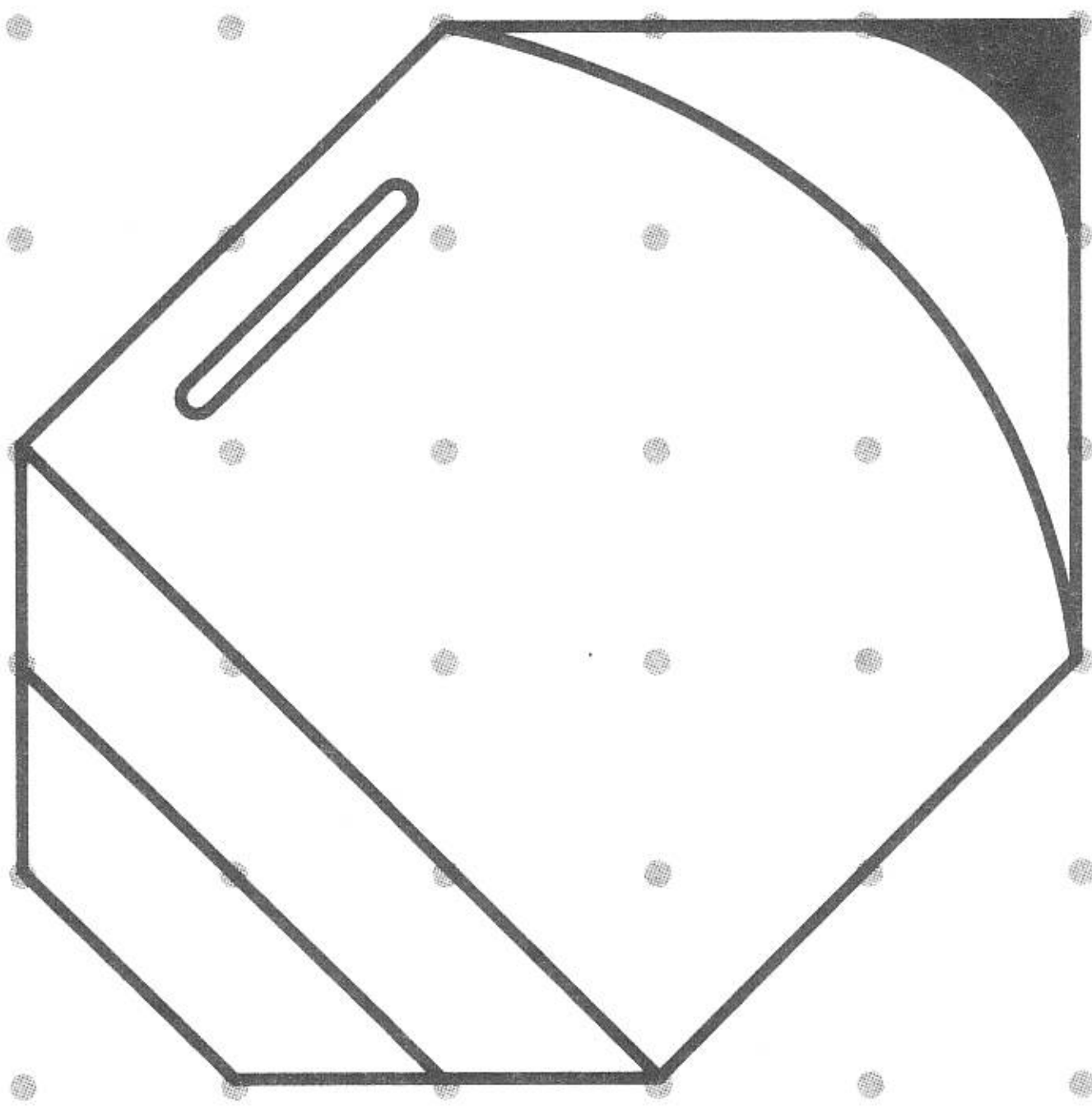

9

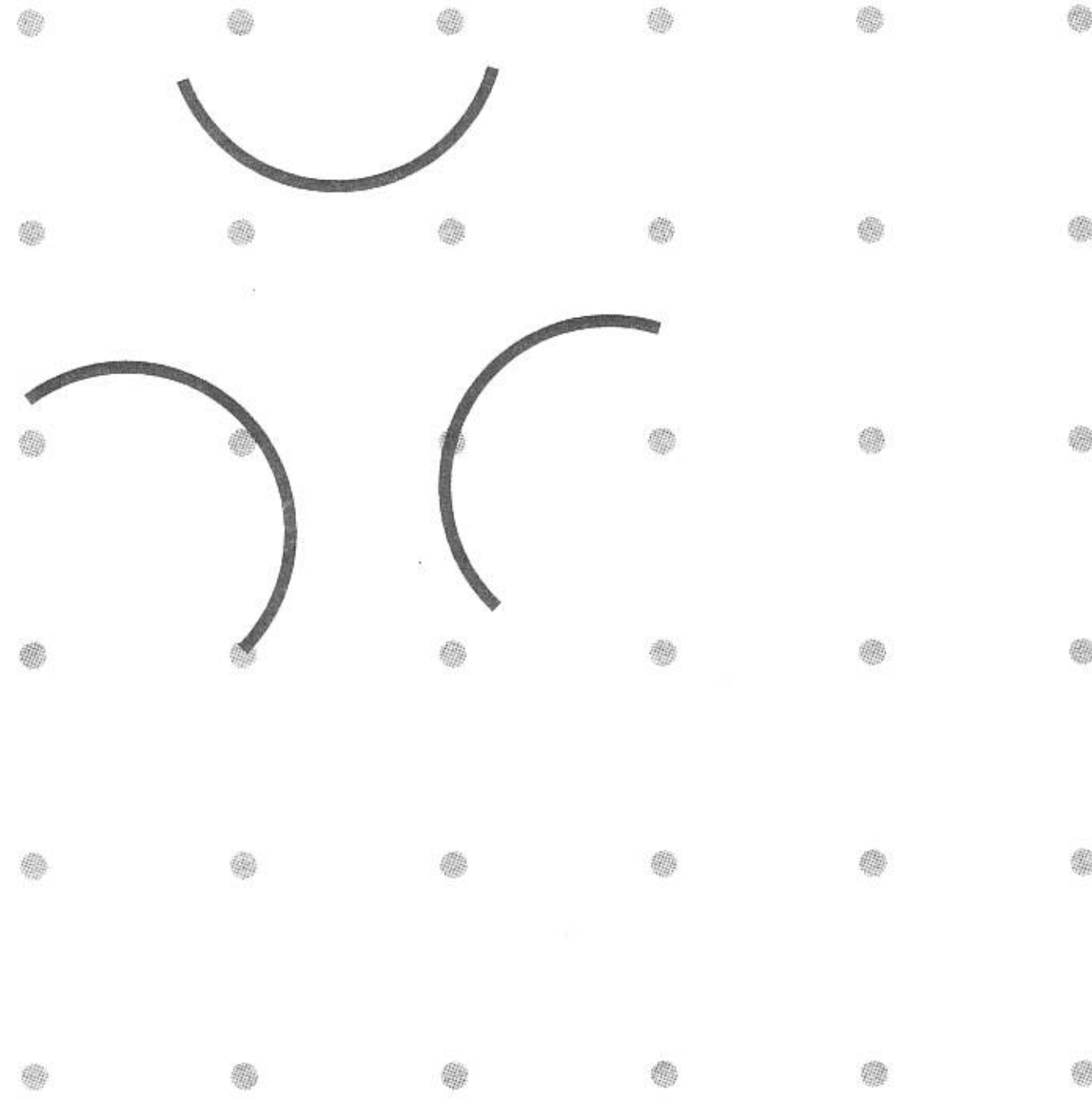

10

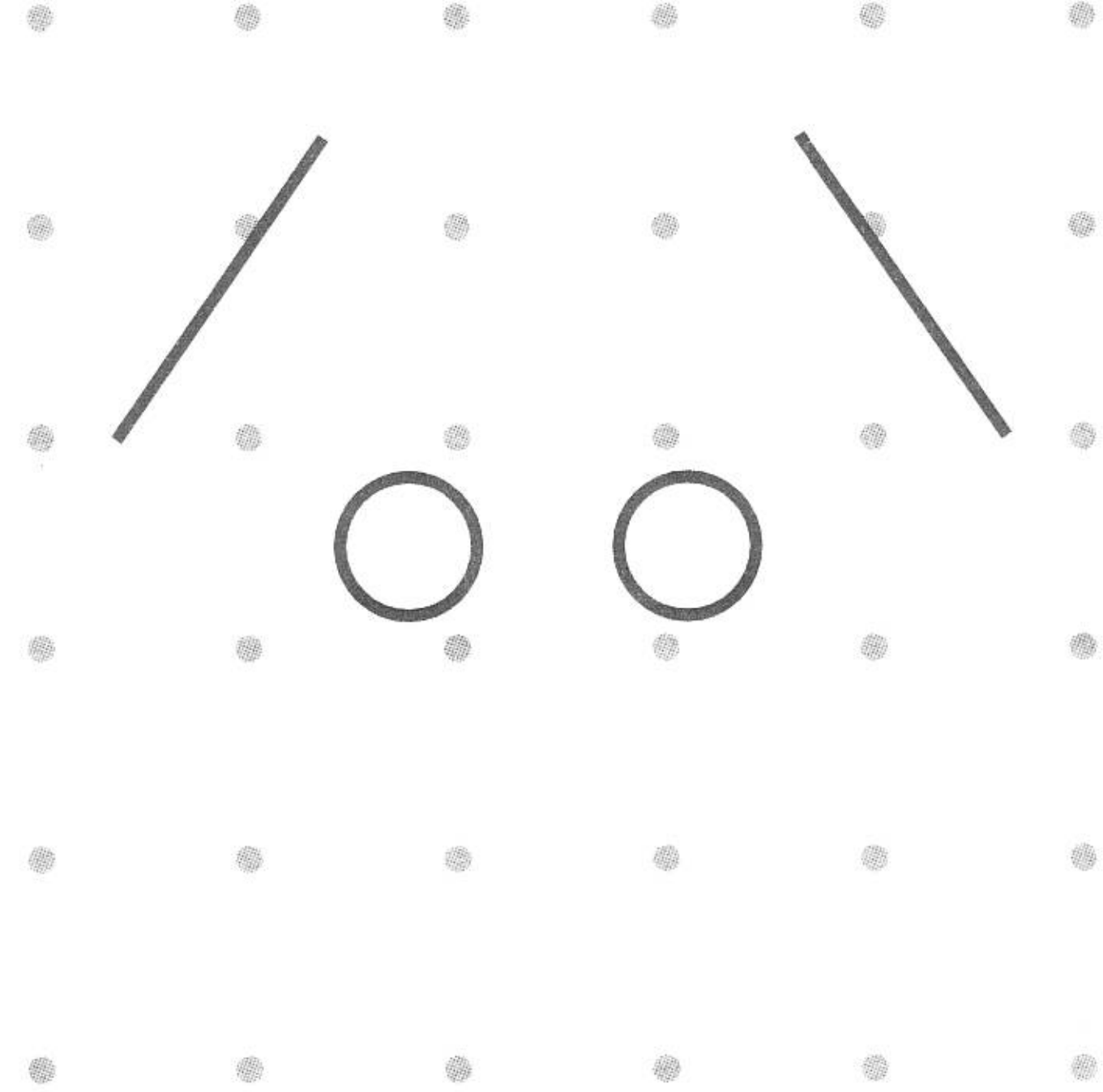
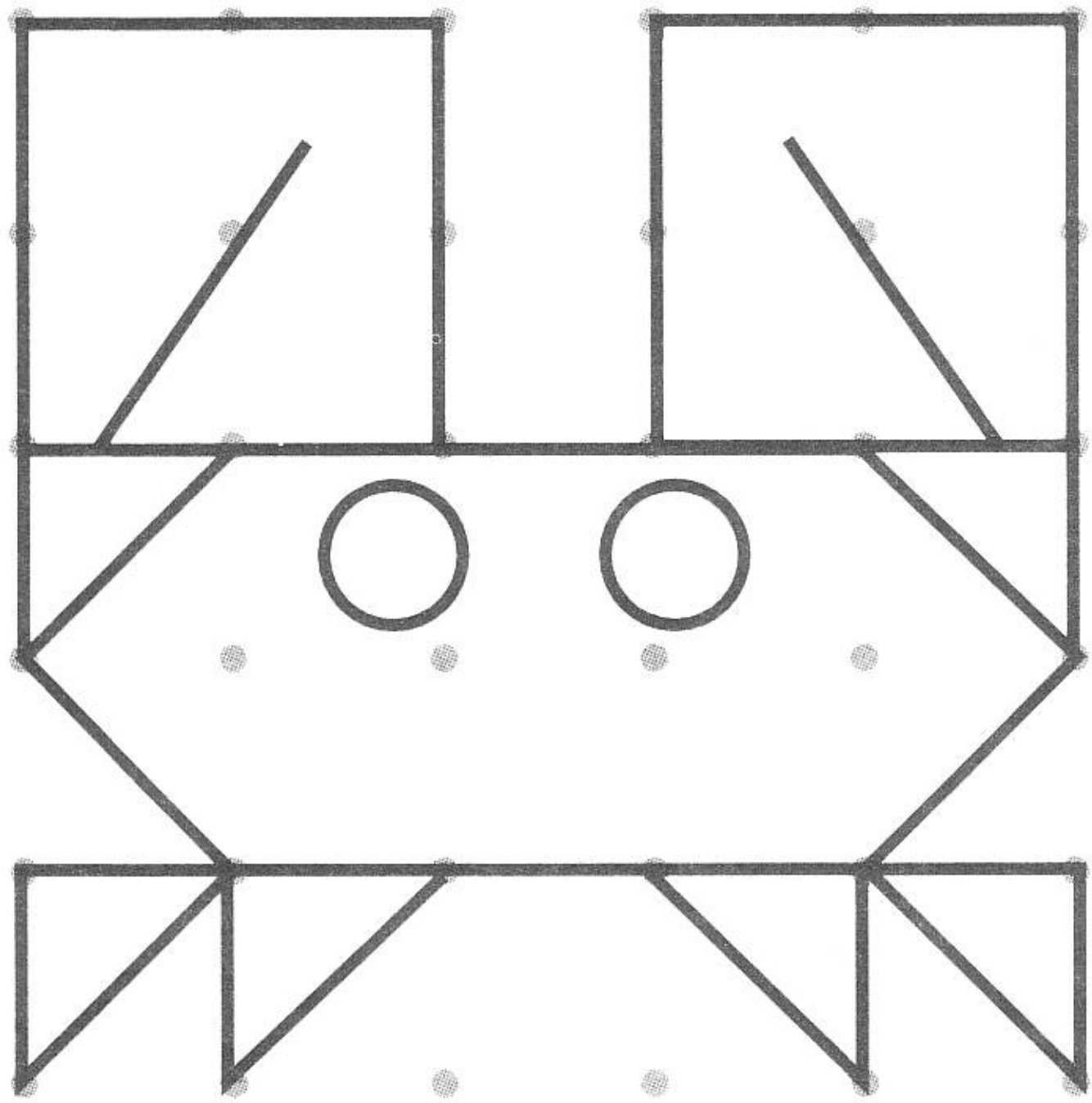

11

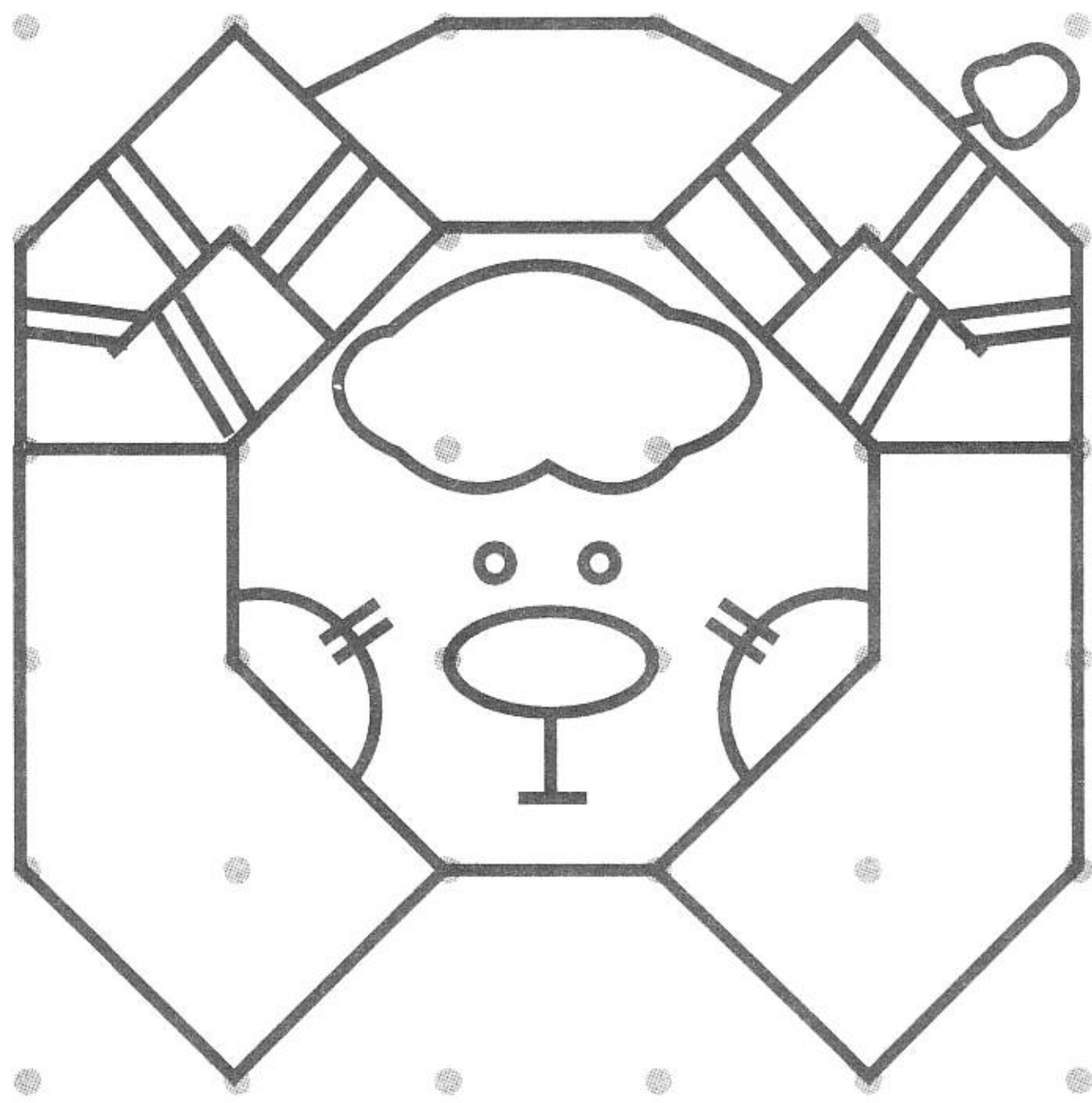

12

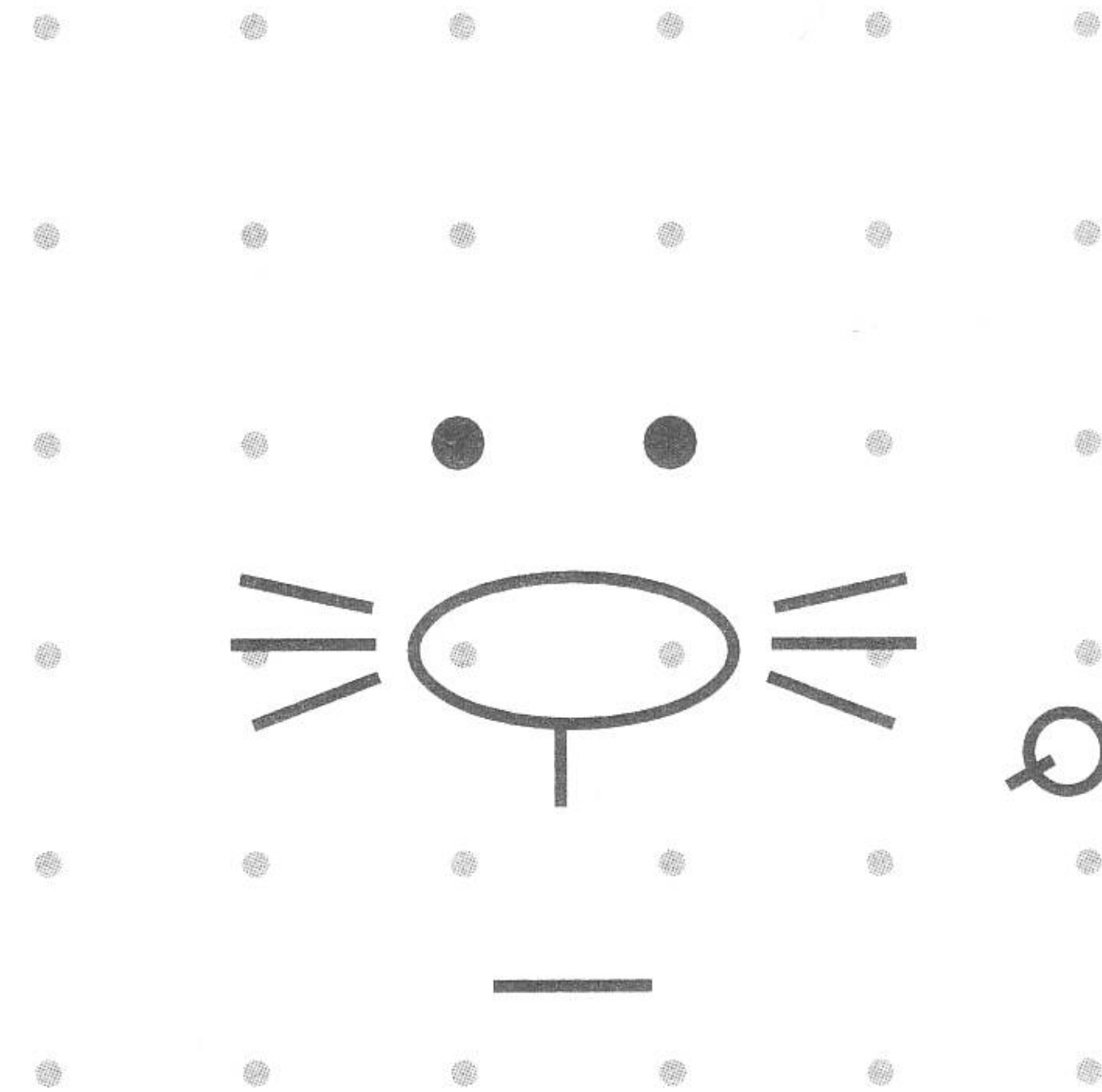
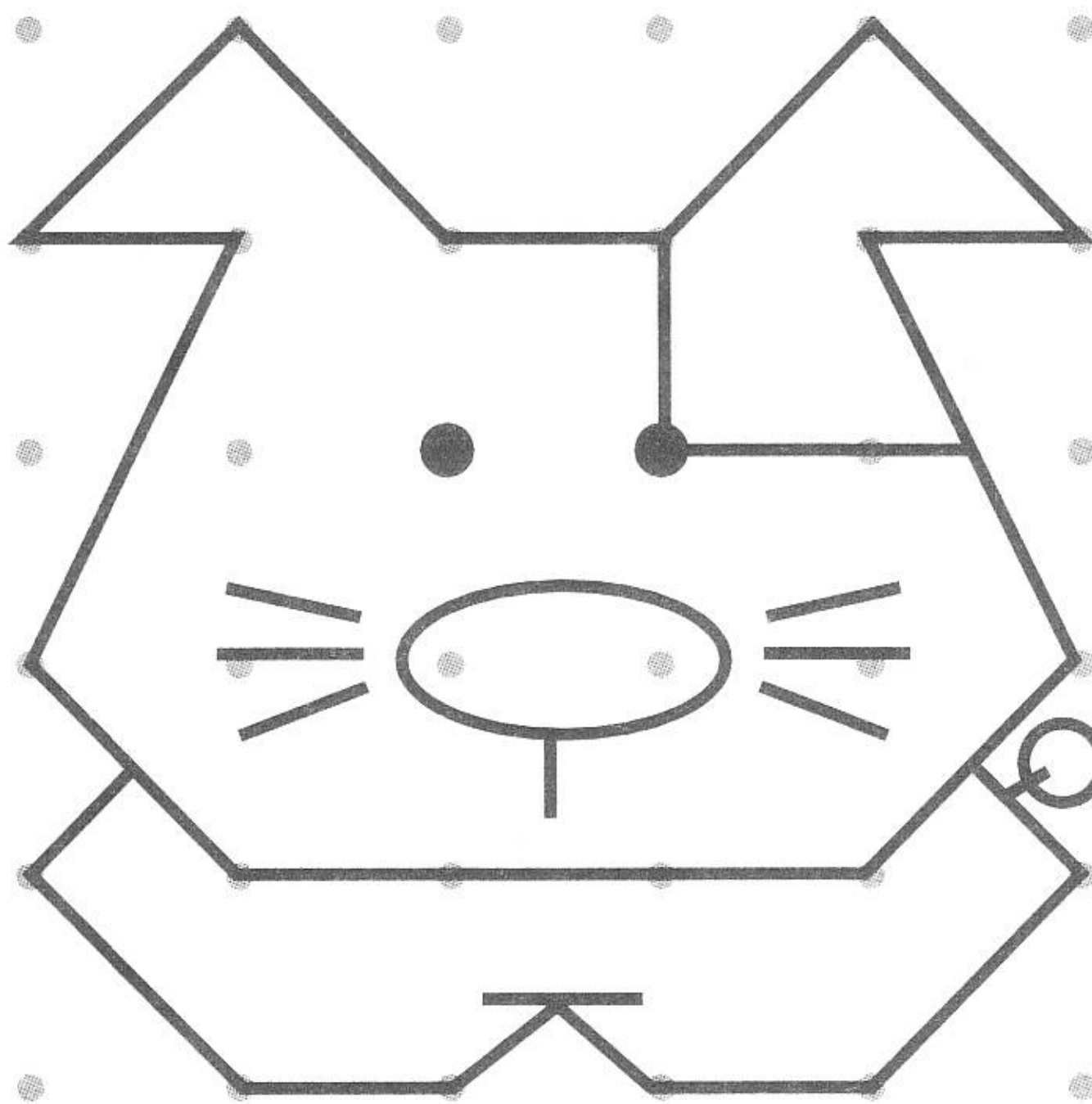

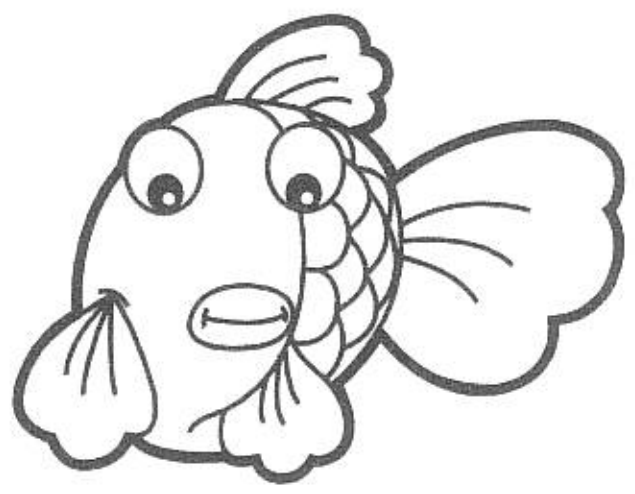

ตอนที่ 5

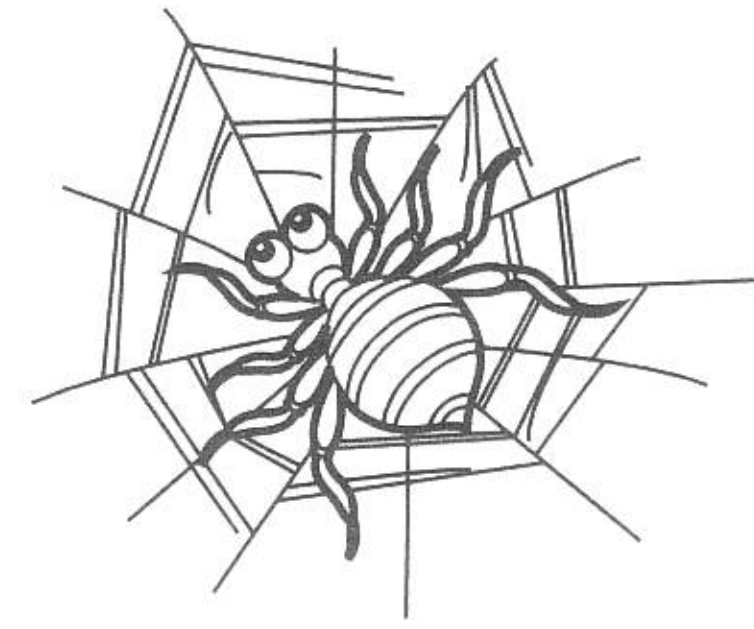

จริยธรรม และความรู้รอบตัว

◇ จำนวน

20 ข้อ

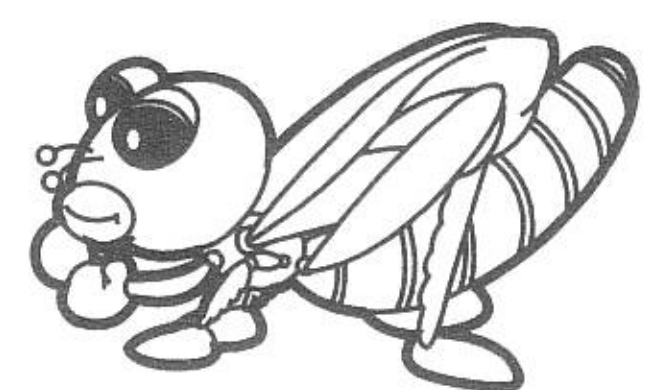

จงขีด ✓ หน้าข้อที่เห็นว่าถูกต้องเหมาะสม

1 ข้อใดเป็นการเล่นที่ถูกต้อง

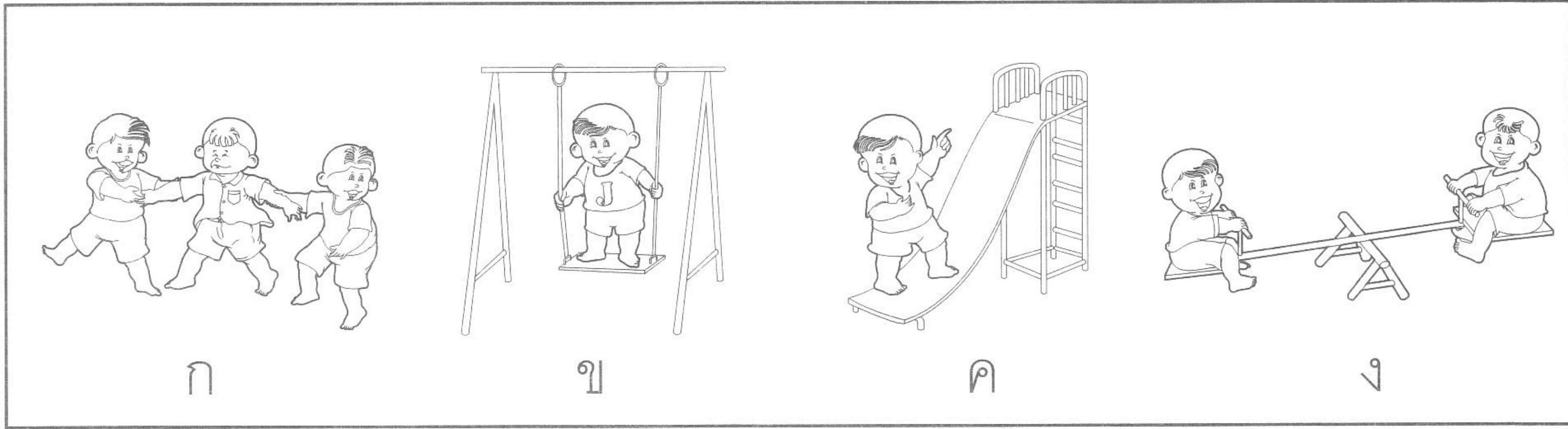

2 หลังจากเล่นฟุตบอลแล้วนักเรียนควรทำอย่างไร

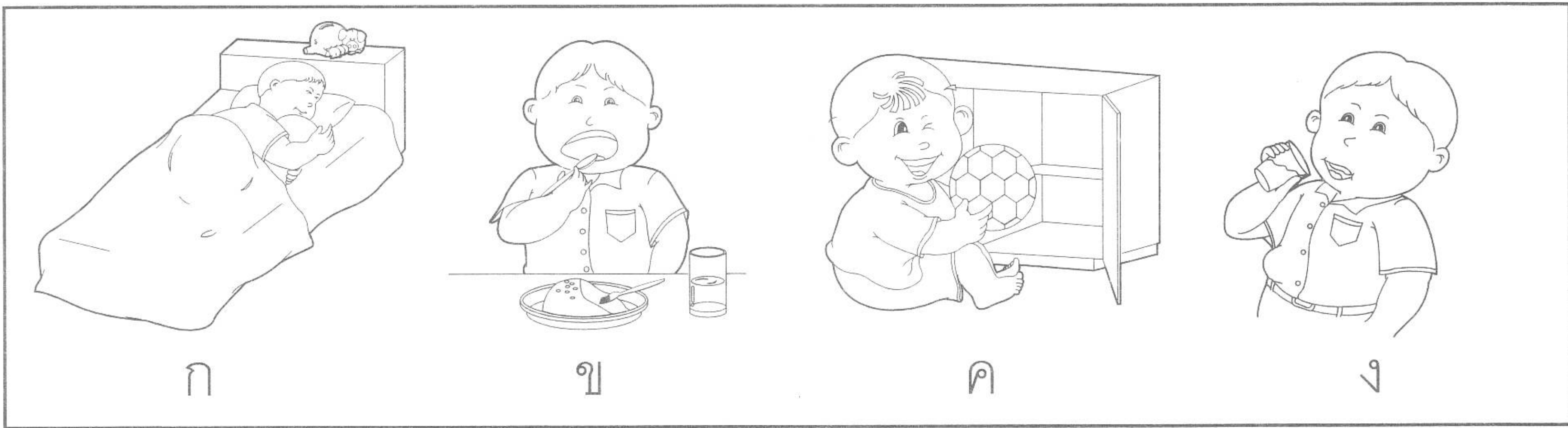

3 งานที่ไม่เหมาะกับนักเรียน

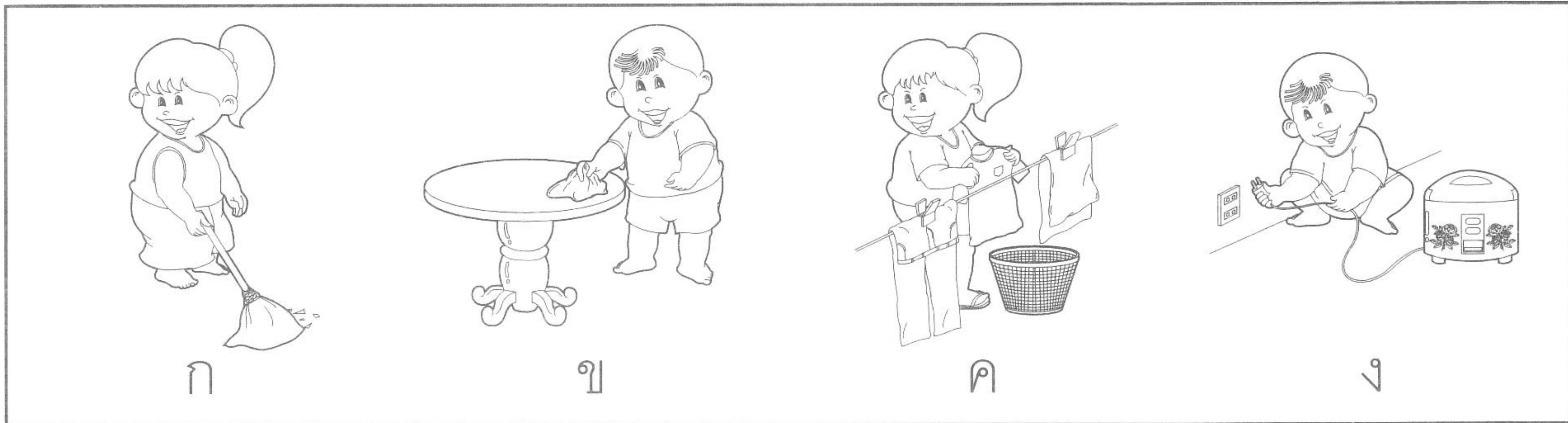

4 ข้อใดไม่ใช่การพักผ่อน

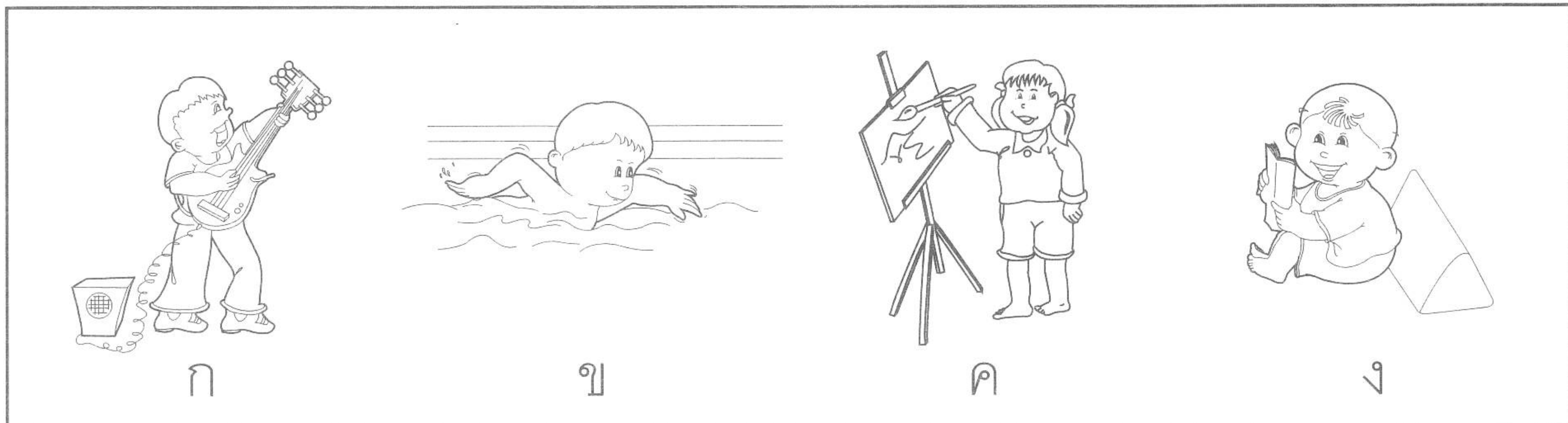

5 ข้อใดเป็นการออกกำลังกายจากการทำงาน

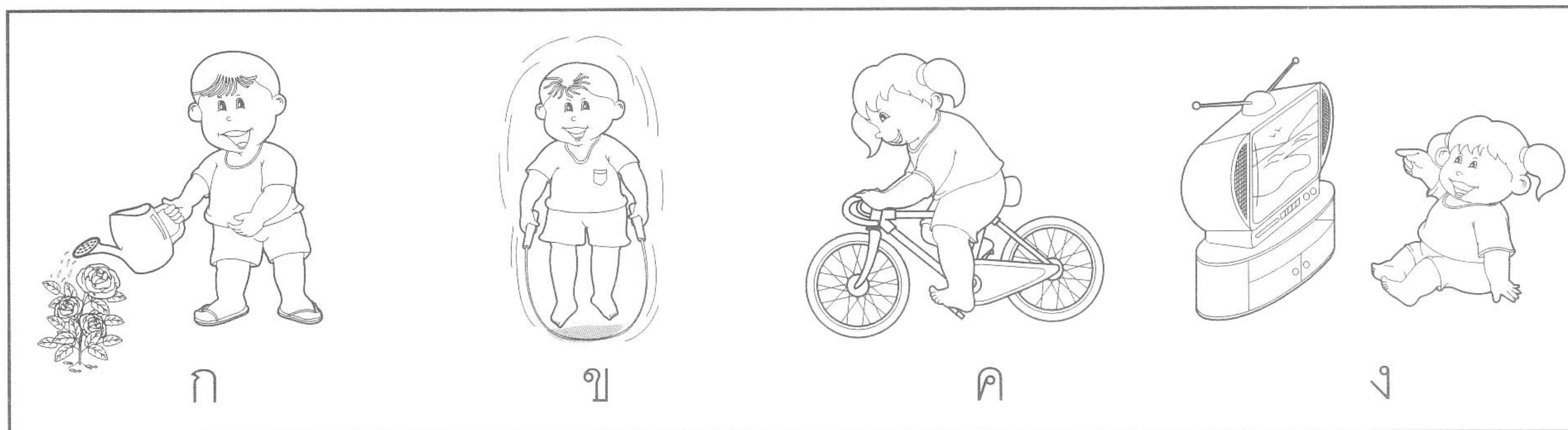

6 ข้อใดเป็นการใช้ไฟอย่างประหยัด

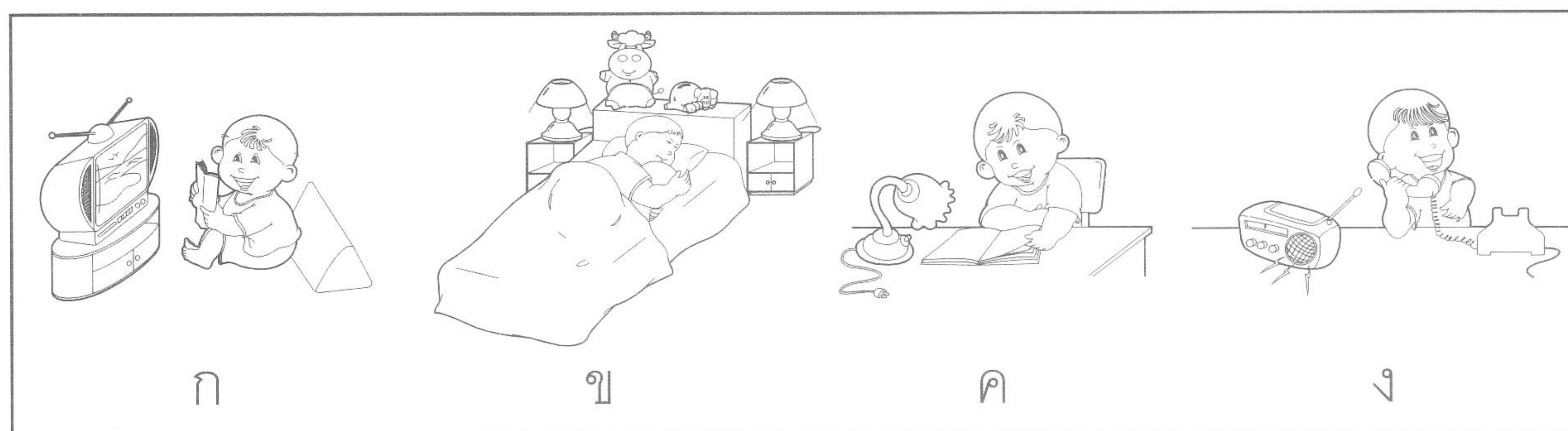

7 ข้อใดเป็นการใช้น้ำอย่างประหยัด



8 ข้อใดเป็นการเล่นที่อาจเกิดอันตรายถึงชีวิต

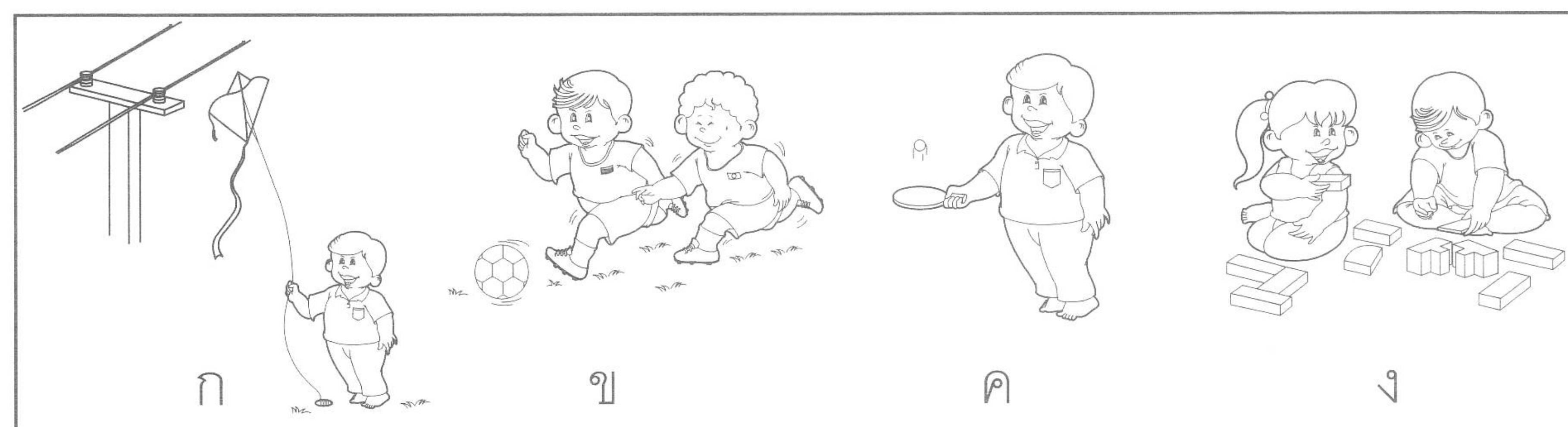

9 ข้อใดเป็นการทำลายสิ่งแวดล้อมทางธรรมชาติ

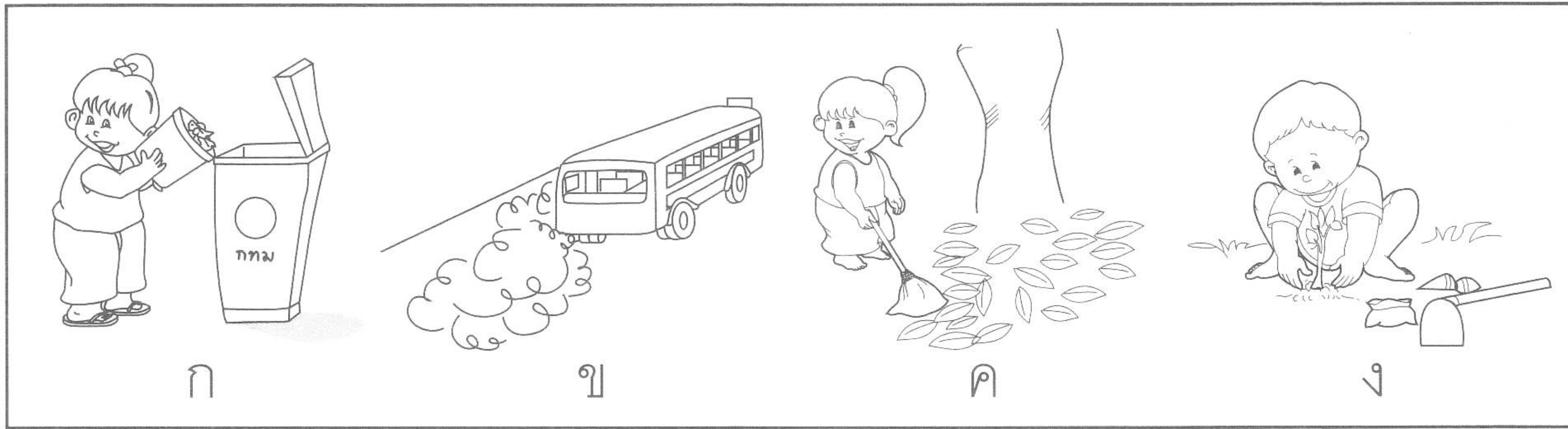

10 ข้อใดทำผิดกฎจราจร

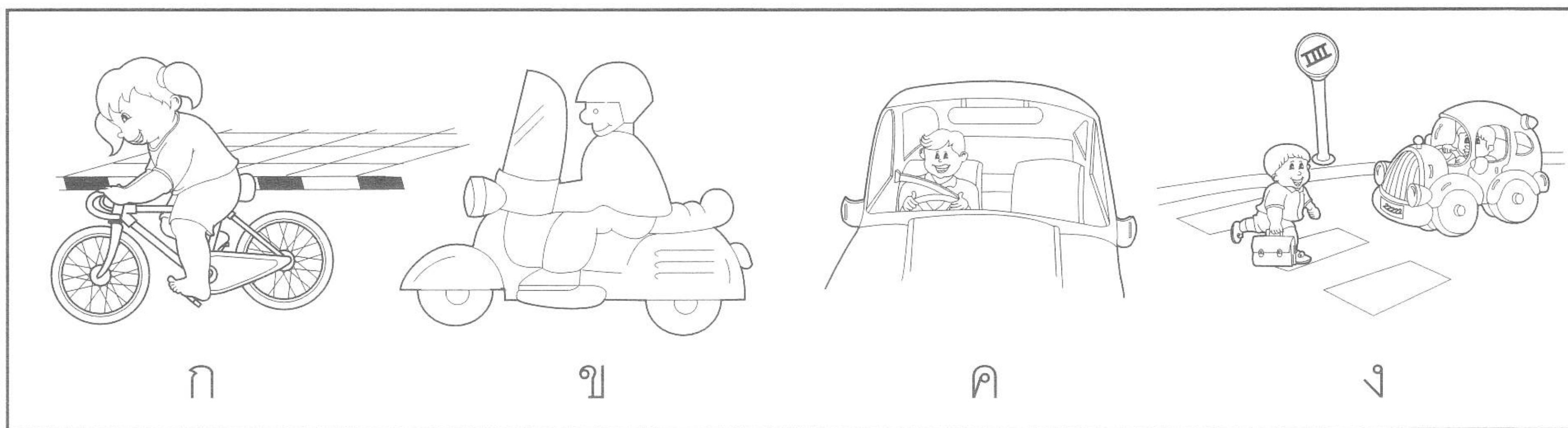

11 ถ้านักเรียนเก็บกระเป๋าสตางค์ได้ที่รถแท็กซี่นักเรียนจะอย่างไร

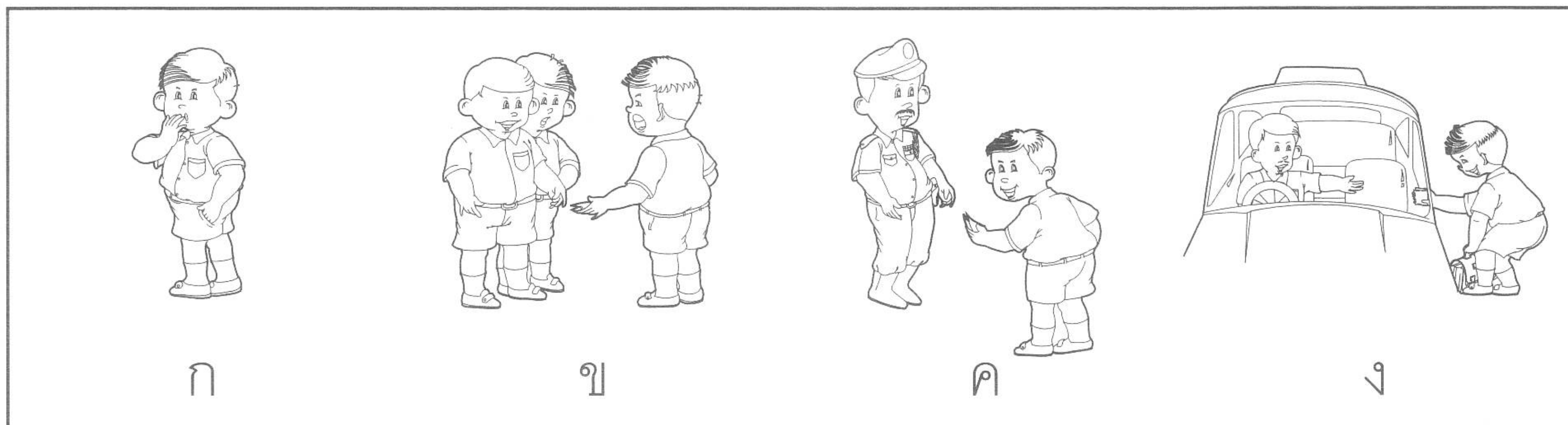

12 ถ้านักเรียนทำแจกันของคุณครูแตกจะอย่างไร

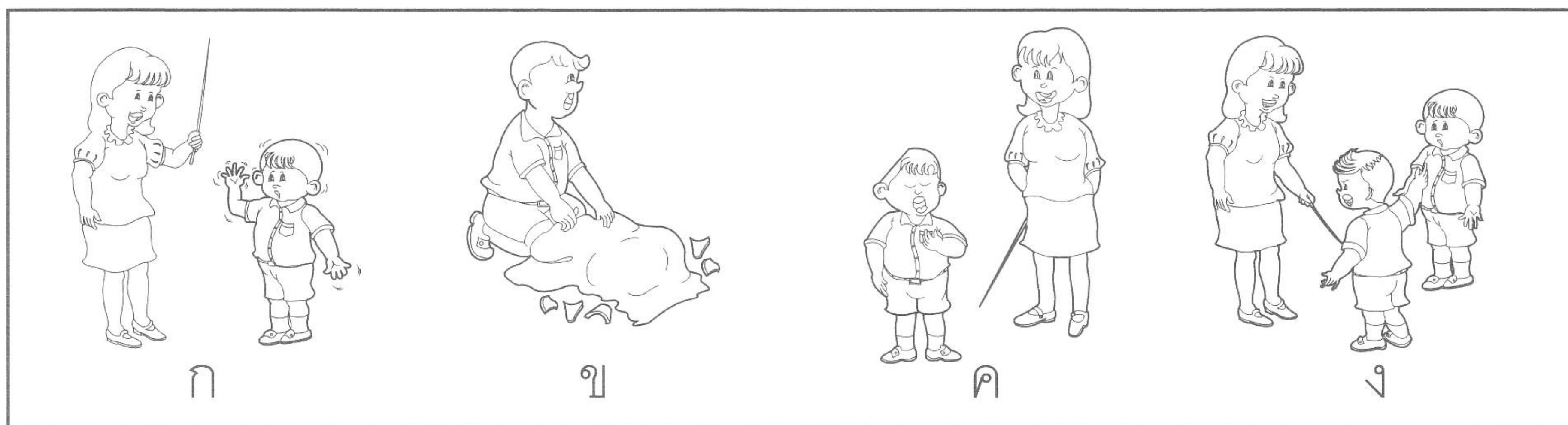

13 ถ้าสุนัขและแมวของนักเรียนแย่งจานอาหารกัน นักเรียนจะทำอย่างไร

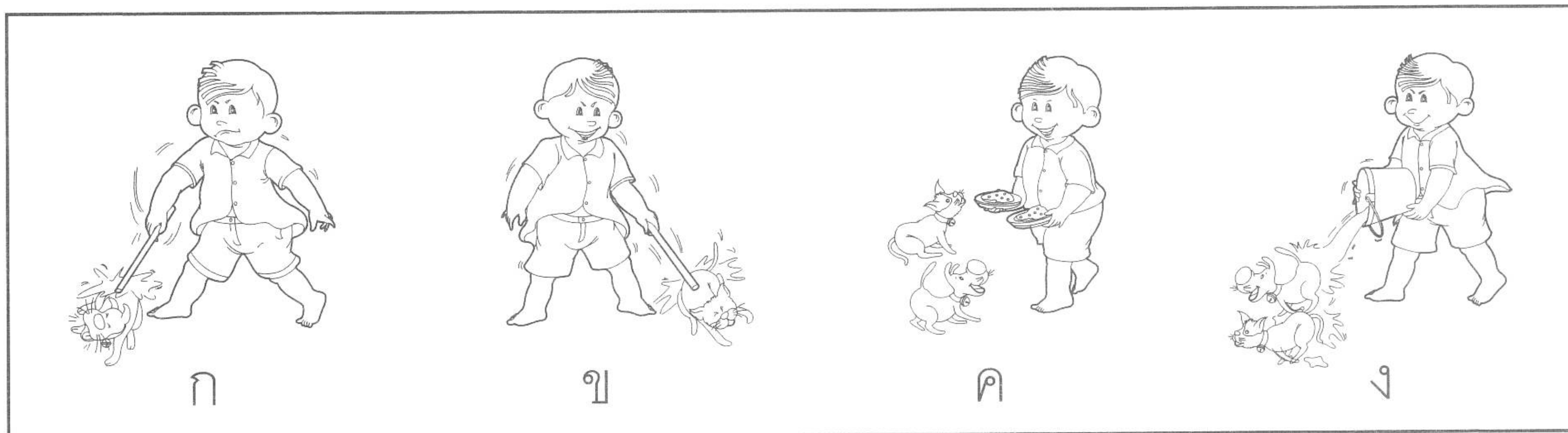

14 สิ่งใดที่ไม่ใช่สิ่งเสพติด

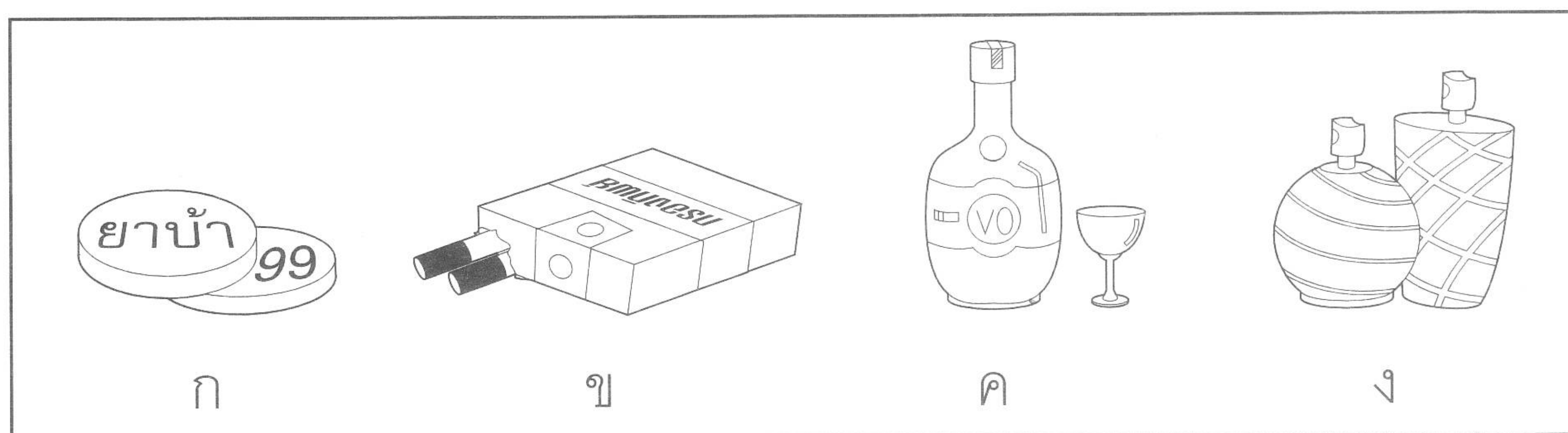

15 สิ่งใดที่นักเรียนไม่ควรนำไปโรงเรียน

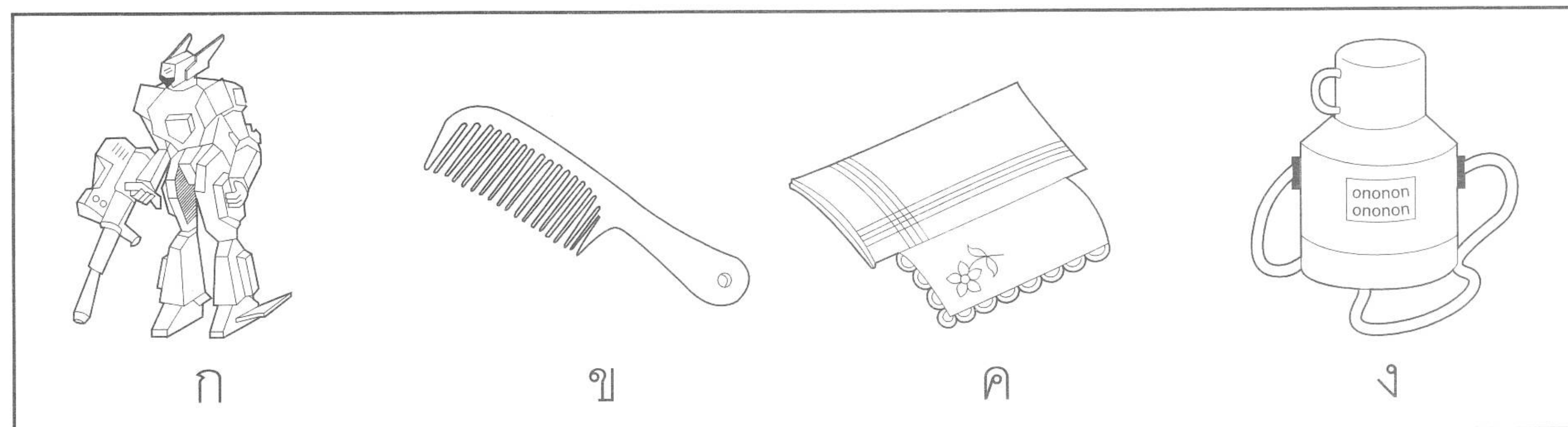

16 ของเล่นใดที่ไม่เหมาะกับนักเรียน

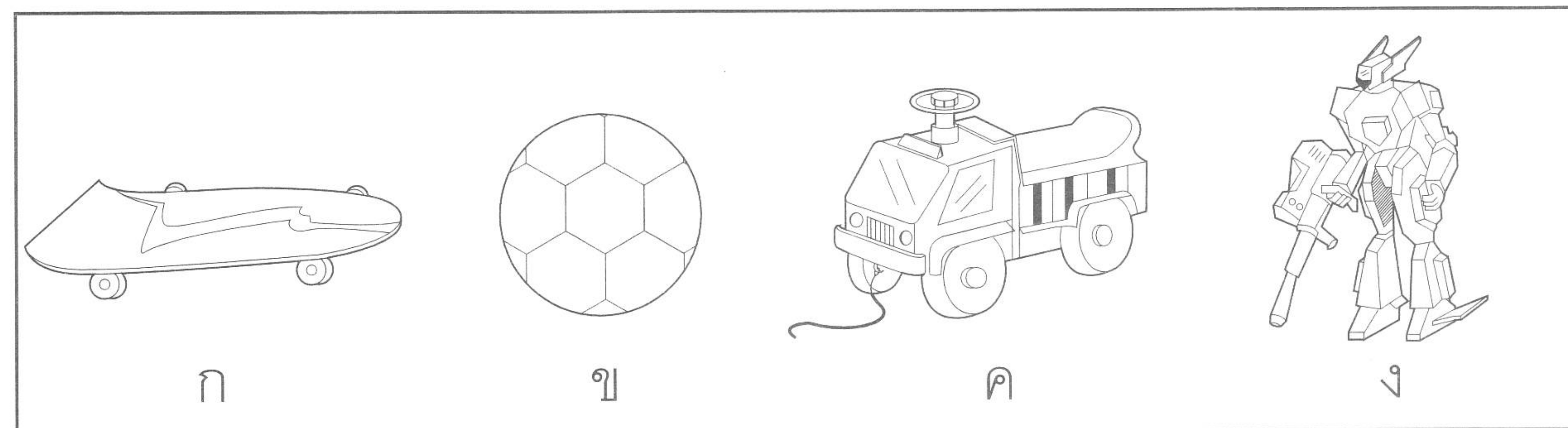

17 เครื่องดื่มที่นักเรียนควรเลือกดื่ม

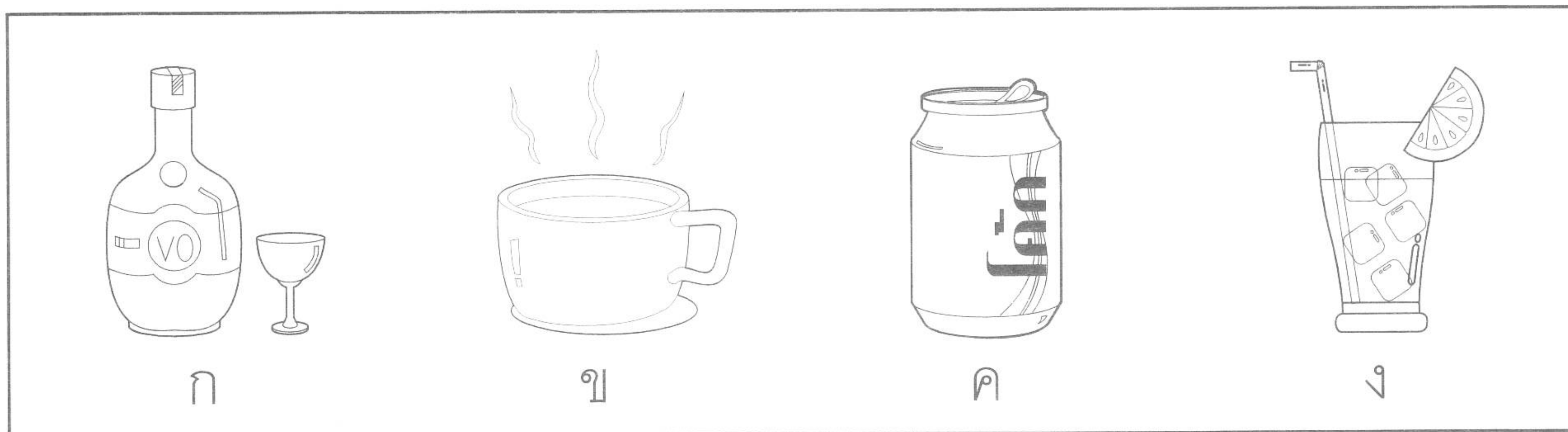

18 การกระทำข้อใดที่นักเรียนจะต้องถูกตำรวจปรับเงิน

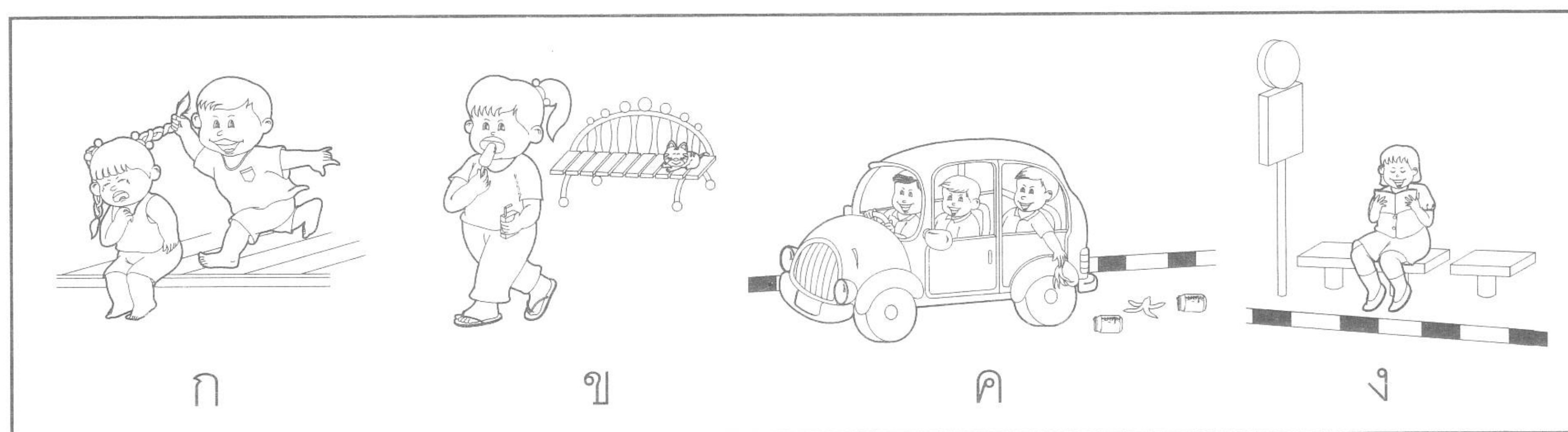

19 ข้อใดเป็นการรักษาวัฒนธรรมไทย

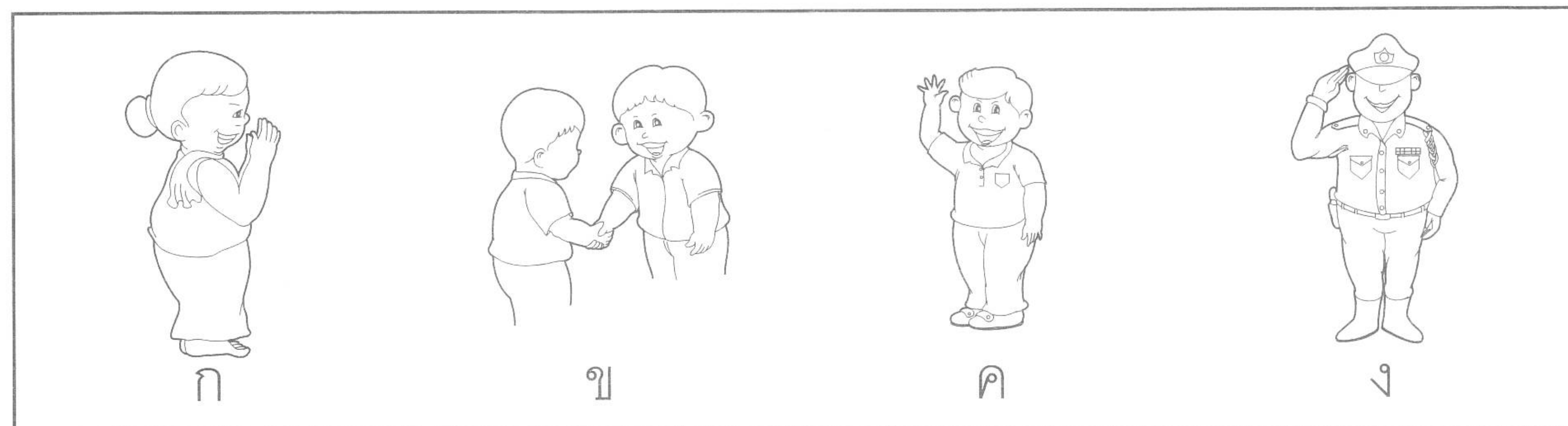

20 สัตว์ตัวใดที่นักเรียนชอบและคิดว่าจะนำมาเลี้ยงในบ้านได้

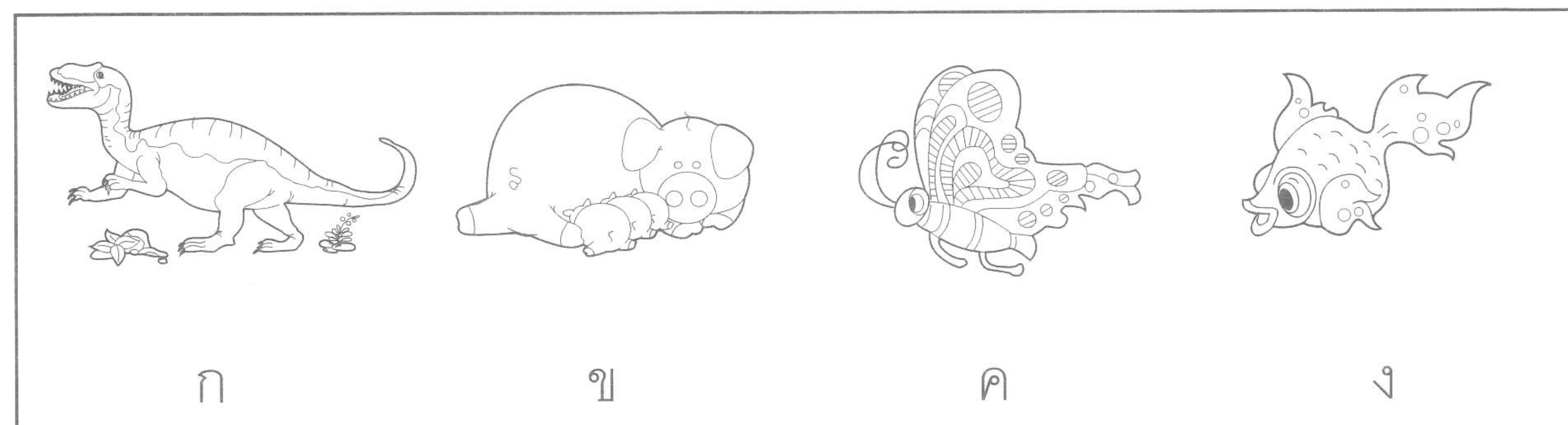

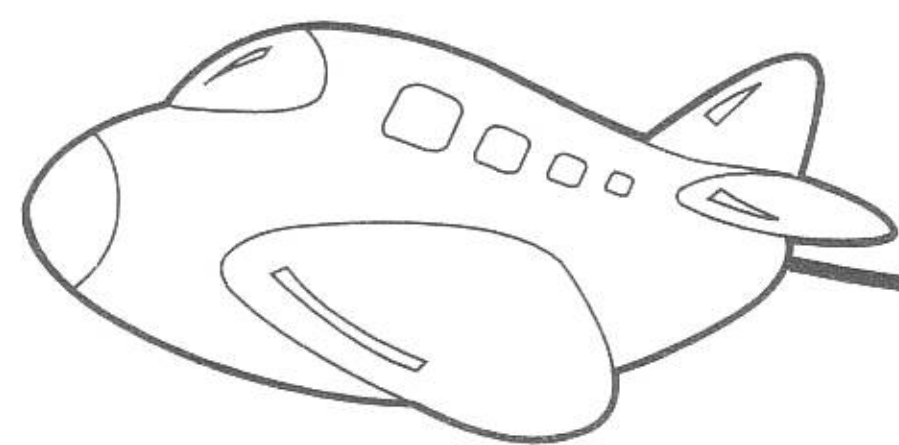

เฉลย

ตอนที่ 1 การจำแนกความเหมือนความต่าง

หน้า 4

จงขีด ✓ ทับภาพที่เหมือนกับภาพที่กำหนดไว้ในช่องแรก

หน้า 5-8

- | | | | | | | | | | |
|-------|-------|-------|-------|-------|-------|-------|-------|-------|-------|
| 1. ค | 2. ข | 3. ก | 4. ก | 5. ข | 6. ข | 7. ค | 8. ง | 9. ง | 10. ค |
| 11. ค | 12. ข | 13. ก | 14. ง | 15. ก | 16. ข | 17. ค | 18. ง | 19. ค | 20. ข |

จงขีด X เงามีจุดตัดของภาพในช่องแรก

หน้า 9-12

- | | | | | | | | | | |
|-------|-------|-------|-------|-------|-------|-------|-------|-------|-------|
| 1. ข | 2. ก | 3. ง | 4. ข | 5. ข | 6. ค | 7. ก | 8. ก | 9. ง | 10. ก |
| 11. ข | 12. ง | 13. ค | 14. ก | 15. ก | 16. ง | 17. ข | 18. ค | 19. ง | 20. ค |

จงขีด ✓ ภาพที่เป็นพวกเดียวกับภาพในช่องแรก

หน้า 13-16

- | | | | | | | | | | |
|-------|-------|-------|-------|-------|-------|-------|-------|-------|-------|
| 1. ข | 2. ค | 3. ง | 4. ก | 5. ข | 6. ค | 7. ก | 8. ง | 9. ก | 10. ค |
| 11. ค | 12. ง | 13. ก | 14. ข | 15. ก | 16. ค | 17. ง | 18. ง | 19. ข | 20. ค |

จงขีด X ภาพที่มีคุณสมบัติเหมือนสิ่งที่กำหนดไว้ในช่องแรก

หน้า 17-20

- | | | | | | | | | | |
|-------|-------|-------|-------|-------|-------|-------|-------|-------|-------|
| 1. ค | 2. ค | 3. ง | 4. ก | 5. ง | 6. ข | 7. ก | 8. ค | 9. ก | 10. ข |
| 11. ก | 12. ค | 13. ง | 14. ค | 15. ก | 16. ค | 17. ง | 18. ก | 19. ก | 20. ข |

จงขีด X ภาพที่แตกต่างจากภาพอื่น

หน้า 21-24

- | | | | | | | | | | |
|-------|-------|-------|-------|-------|-------|-------|-------|-------|-------|
| 1. ก | 2. ข | 3. ง | 4. ข | 5. ค | 6. ง | 7. ค | 8. ค | 9. ข | 10. ง |
| 11. ค | 12. ข | 13. ค | 14. ข | 15. ง | 16. ก | 17. ง | 18. ค | 19. ข | 20. ค |

จงขีด ✓ ภาพที่มีคุณสมบัติต่างจากภาพอื่น

หน้า 25-28

- | | | | | | | | | | |
|-------|-------|-------|-------|-------|-------|-------|-------|-------|-------|
| 1. ง | 2. ข | 3. ค | 4. ก | 5. ค | 6. ค | 7. ข | 8. ก | 9. ง | 10. ง |
| 11. ข | 12. ก | 13. ง | 14. ข | 15. ค | 16. ง | 17. ก | 18. ค | 19. ง | 20. ค |

ตอนที่ 2 ลำดับเหตุการณ์

หน้า 29

จงลำดับเหตุการณ์โดยใส่ตัวเลขใน

หน้า 30-39

- | | | | | | | | | | |
|---------|---------|---------|---------|---------|---------|---------|---------|---------|---------|
| 1. ก-4 | 2. ก-3 | 3. ก-1 | 4. ก-4 | 5. ก-2 | 6. ก-3 | 7. ก-2 | 8. ก-4 | 9. ก-3 | 10. ก-1 |
| ข-2 | ข-1 | ข-4 | ข-3 | ข-1 | ข-4 | ข-3 | ข-1 | ข-1 | ข-2 |
| ค-3 | ค-4 | ค-2 | ค-1 | ค-4 | ค-1 | ค-1 | ค-2 | ค-4 | ค-3 |
| ง-1 | ง-2 | ง-3 | ง-2 | ง-3 | ง-2 | ง-4 | ง-3 | ง-2 | ง-4 |
| 11. ก-2 | 12. ก-1 | 13. ก-4 | 14. ก-2 | 15. ก-1 | 16. ก-3 | 17. ก-1 | 18. ก-3 | 19. ก-2 | 20. ก-3 |
| ข-1 | ข-3 | ข-3 | ข-1 | ข-3 | ข-2 | ข-2 | ข-2 | ข-4 | ข-1 |
| ค-4 | ค-2 | ค-1 | ค-3 | ค-2 | ค-4 | ค-3 | ค-1 | ค-1 | ค-4 |
| ง-3 | ง-4 | ง-2 | ง-4 | ง-4 | ง-1 | ง-4 | ง-4 | ง-3 | ง-2 |

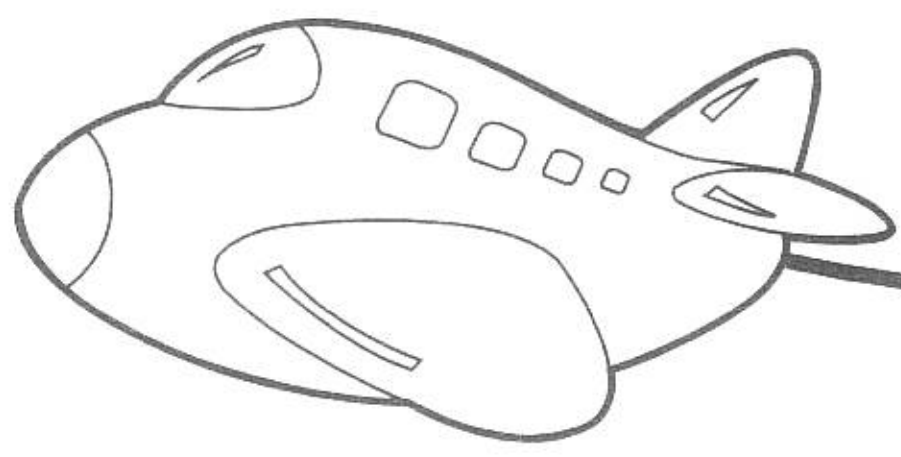

เฉลย

ตอนที่ 3 การหาภาพสมบูรณ์

หน้า 40

จงขีด ✓ ภาพที่นำมาประกอบแล้วได้ภาพตามแบบที่กำหนดให้

หน้า 41-50

- | | | | | | | | | | |
|-------|-------|-------|-------|-------|-------|-------|-------|-------|-------|
| 1. ก | 2. ค | 3. ข | 4. ง | 5. ค | 6. ข | 7. ค | 8. ข | 9. ข | 10. ก |
| 11. ค | 12. ข | 13. ค | 14. ง | 15. ก | 16. ง | 17. ง | 18. ก | 19. ข | 20. ง |

จงต่อลายไม้บล็อกให้ถูกต้องโดยเลือก ข้อที่ถูก

หน้า 51-58

- | | | | | | | | | | |
|-------|-------|-------|-------|-------|-------|-------|-------|-------|-------|
| 1. ค | 2. ง | 3. ก | 4. ค | 5. ง | 6. ค | 7. ก | 8. ข | 9. ค | 10. ง |
| 11. ก | 12. ข | 13. ข | 14. ก | 15. ค | 16. ง | 17. ข | 18. ก | 19. ง | 20. ข |
| 21. ค | 22. ค | 23. ข | 24. ค | | | | | | |

จงขีด ✓ ภาพที่มีลายเข้าชุดกับภาพด้านบน

หน้า 59-68

- | | | | | | | | | | |
|-------|-------|-------|-------|-------|-------|-------|-------|-------|-------|
| 1. ข | 2. ง | 3. ก | 4. ง | 5. ข | 6. ก | 7. ค | 8. ข | 9. ง | 10. ก |
| 11. ข | 12. ข | 13. ง | 14. ค | 15. ข | 16. ง | 17. ข | 18. ค | 19. ค | 20. ค |

จงขีด X ภาพที่ซ่อนอยู่ในภาพแรก

หน้า 69-72

- | | | | | | | | | | |
|-------|-------|-------|-------|-------|-------|-------|-------|-------|-------|
| 1. ก | 2. ง | 3. ข | 4. ค | 5. ก | 6. ง | 7. ง | 8. ก | 9. ข | 10. ข |
| 11. ค | 12. ก | 13. ข | 14. ง | 15. ก | 16. ข | 17. ง | 18. ก | 19. ค | 20. ค |

จงขีด X ภาพที่เกิดจากการรวมกันของภาพที่กำหนด

หน้า 73-80

- | | | | | | | | | | |
|-------|-------|-------|-------|-------|-------|------|------|------|-------|
| 1. ข | 2. ก | 3. ก | 4. ก | 5. ก | 6. ค | 7. ข | 8. ง | 9. ค | 10. ง |
| 11. ก | 12. ข | 13. ก | 14. ค | 15. ข | 16. ง | | | | |

ตอนที่ 4 การวาดภาพตามแบบที่กำหนด

หน้า 81

จงวาดภาพตามแบบที่กำหนดให้

หน้า 82-83

จงลากเส้นต่อจุดให้เหมือนภาพตัวอย่าง

หน้า 84-87

(มีเฉลยตามภาพต้นแบบในแบบฝึกหัดแล้ว)

ตอนที่ 5 จริยธรรมและความรู้รอบตัว

หน้า 88

จงขีด ✓ หน้าข้อที่เห็นว่าถูกต้องเหมาะสม

หน้า 89-93

- | | | | | | | | | | |
|-------|-------|-------|-------|-------|-------|-------|-------|-------|-------|
| 1. ง | 2. ค | 3. ง | 4. ข | 5. ก | 6. ค | 7. ง | 8. ก | 9. ข | 10. ก |
| 11. ค | 12. ค | 13. ค | 14. ง | 15. ก | 16. ก | 17. ง | 18. ค | 19. ก | 20. ง |