



# ตอนที่ 1

## ความรู้ทางคณิตศาสตร์

- การนับจำนวนไม้บล็อก 20 ข้อ
- การหาจำนวนตามคำสั่ง 40 ข้อ
- โจทย์ปัญหาการบวก-ลบ 30 ข้อ
- การนับจำนวนกล่องที่สัมพันธ์กับกล่องที่กำหนด 20 ข้อ
- การนับจำนวนสัตว์จากรอยเท้า 15 ข้อ



จงขีด ✓ ข้อที่มีจำนวนพระอาทิตย์เท่ากับไม้บล็อก

1

	 ก	 ข	 ค	 ง
--	-------	-------	-------	-------

2

	 ก	 ข	 ค	 ง
--	-------	-------	-------	-------

3

	 ก	 ข	 ค	 ง
--	-------	-------	-------	-------

4

	 ก	 ข	 ค	 ง
--	-------	-------	-------	-------

5

	 ก	 ข	 ค	 ง
--	-------	-------	-------	-------

6

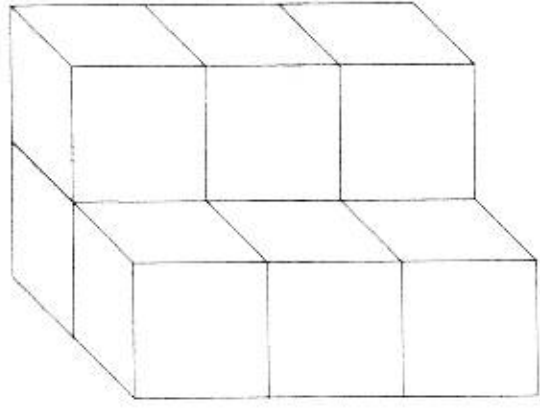
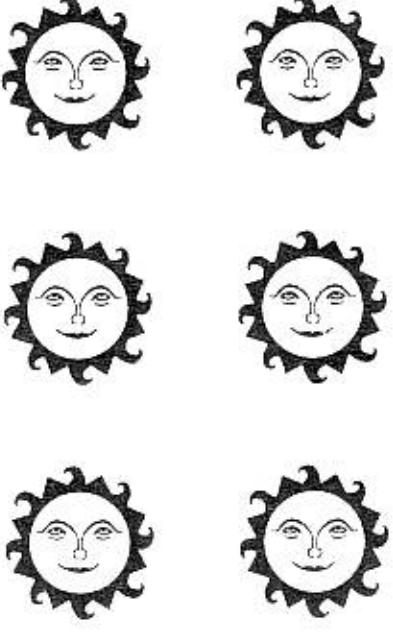
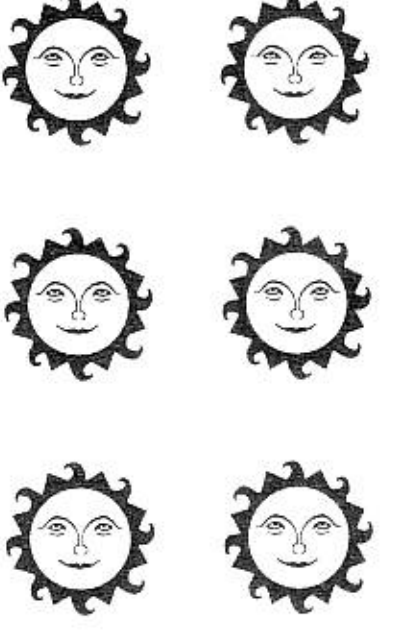
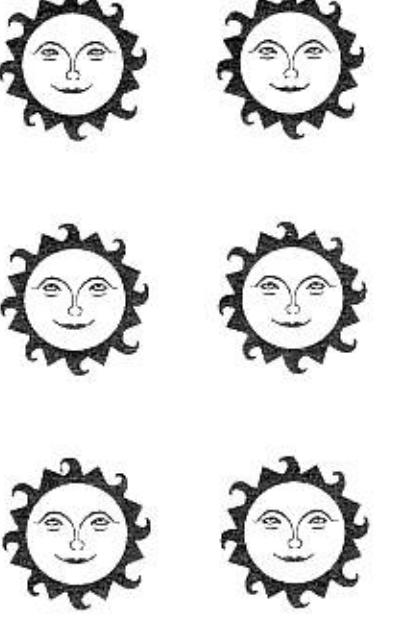
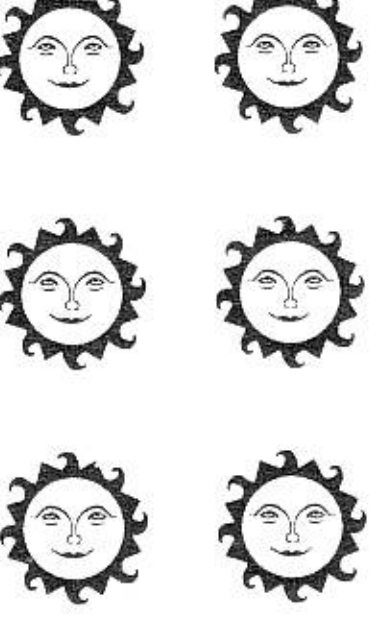
	 <p>၆</p>	 <p>၆</p>	 <p>၆</p>	 <p>၆</p>
---	--	---	--	--

7

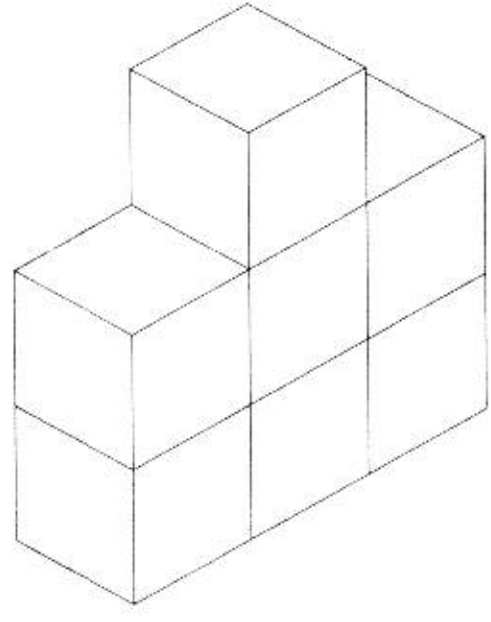
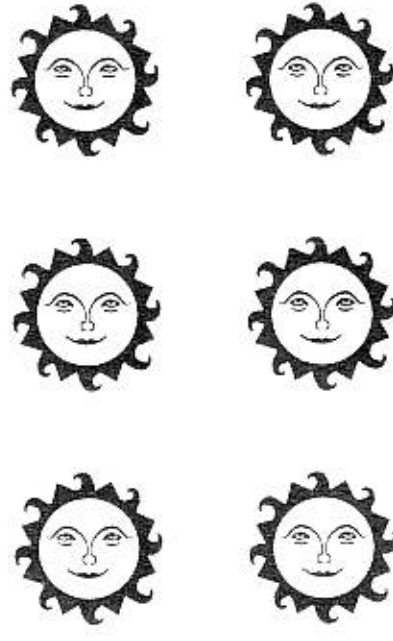
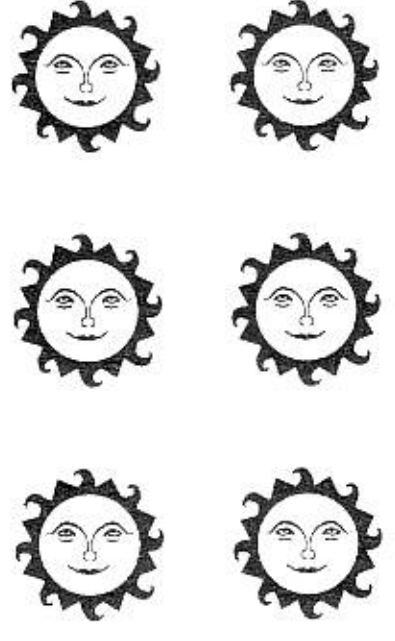
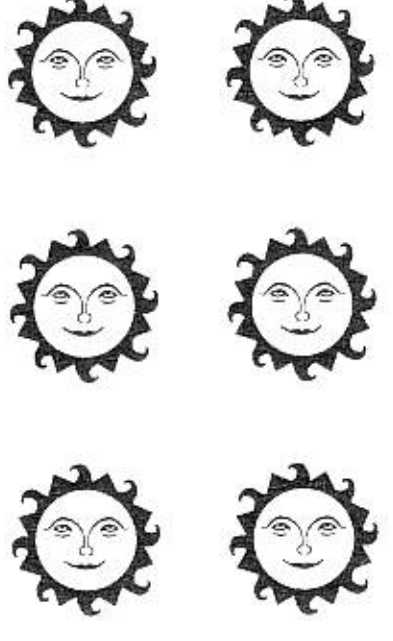
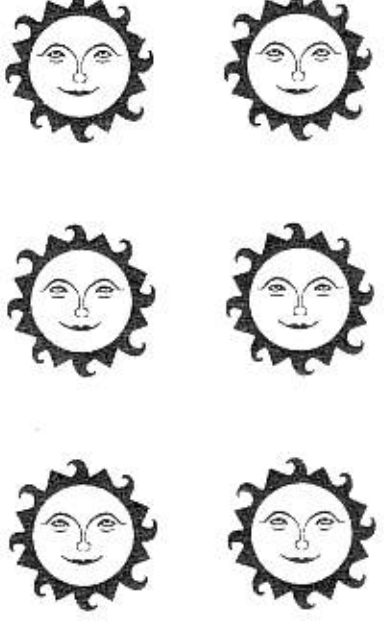
	 <p>၆</p>	 <p>၆</p>	 <p>၆</p>	 <p>၆</p>
--	---	--	---	---

8

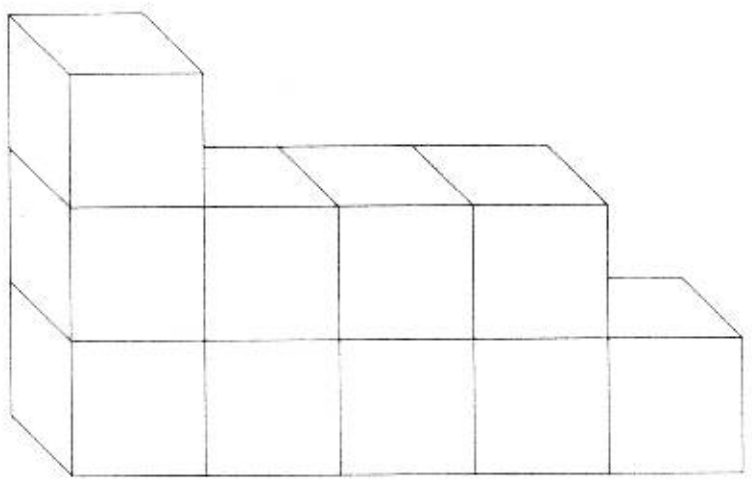
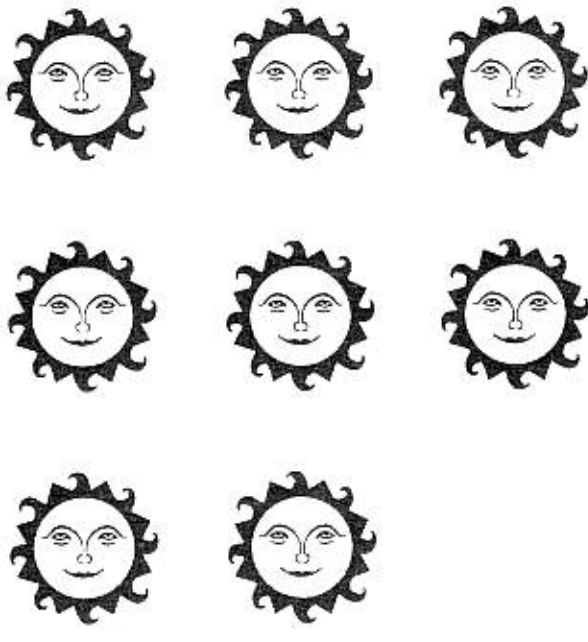
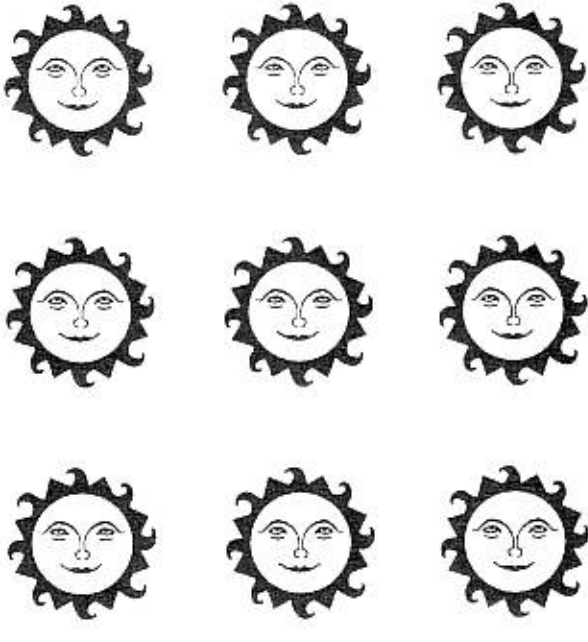
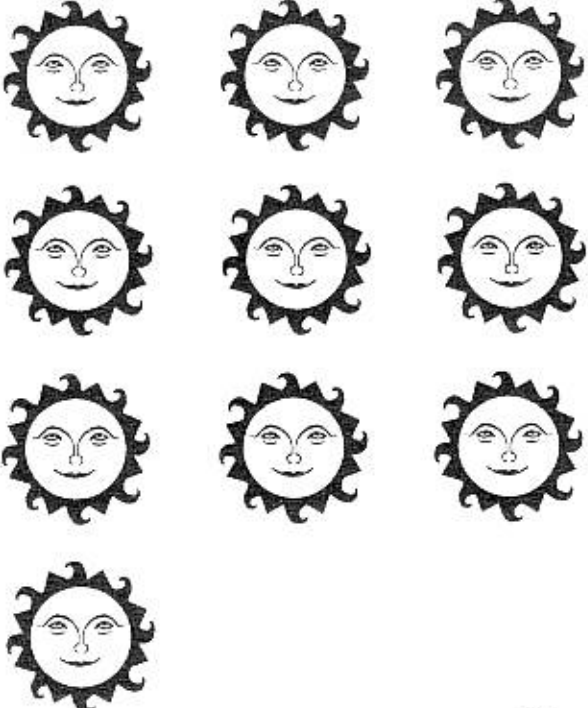
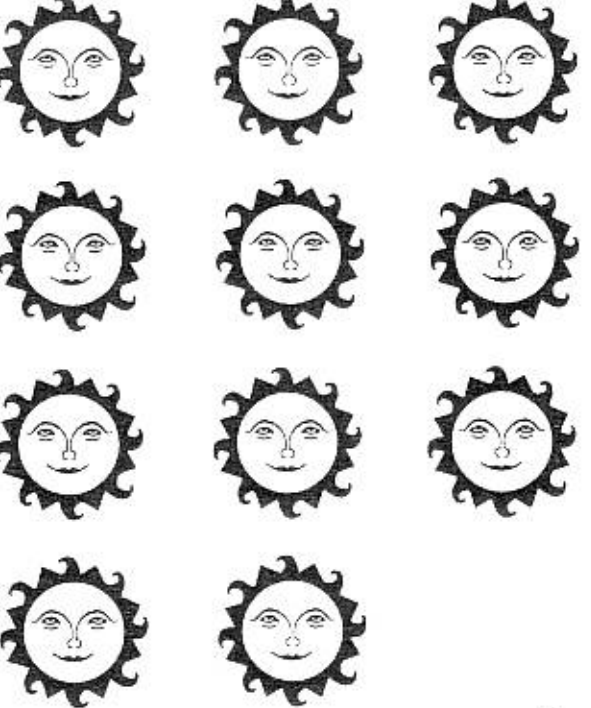
	 <p>၆</p>	 <p>၆</p>	 <p>၆</p>	 <p>၆</p>
---	--	---	--	--

9

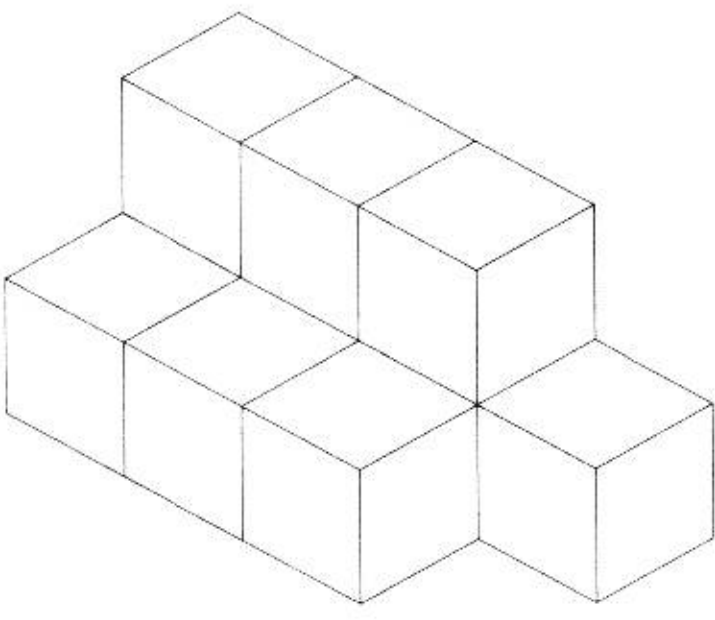
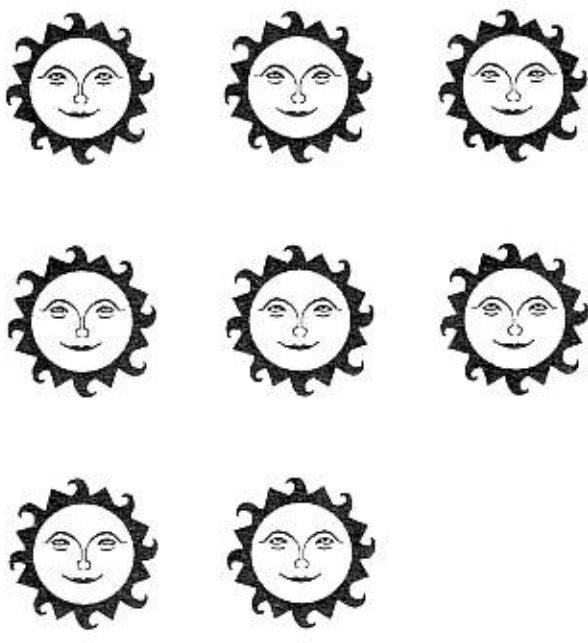
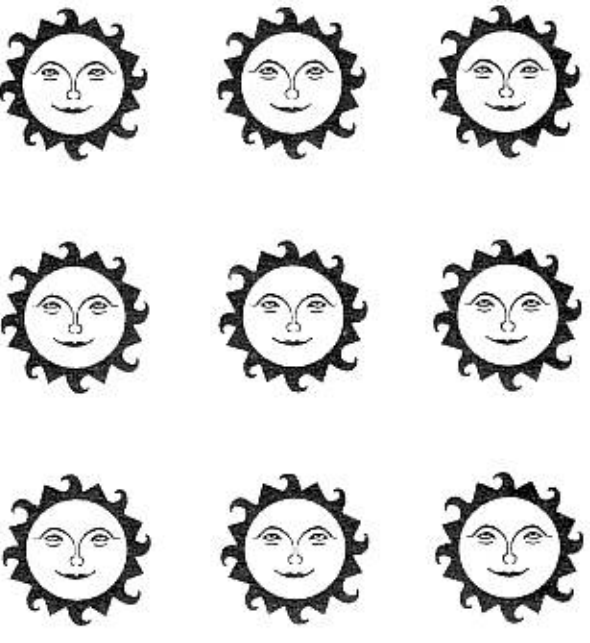
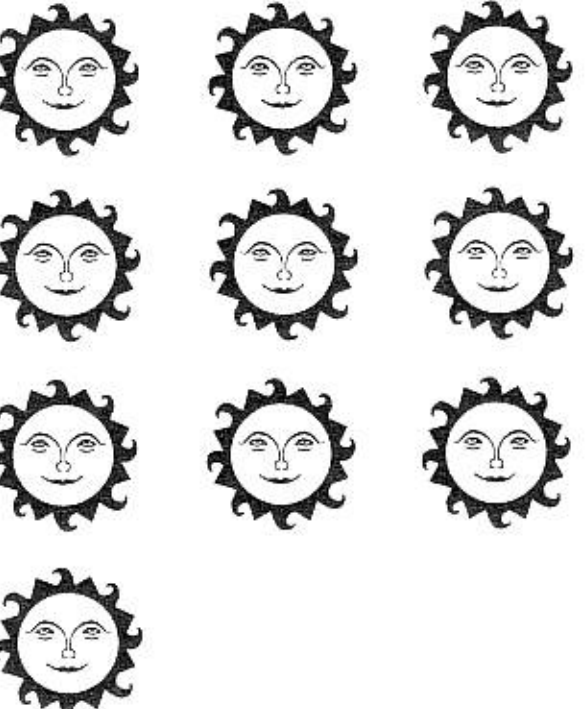
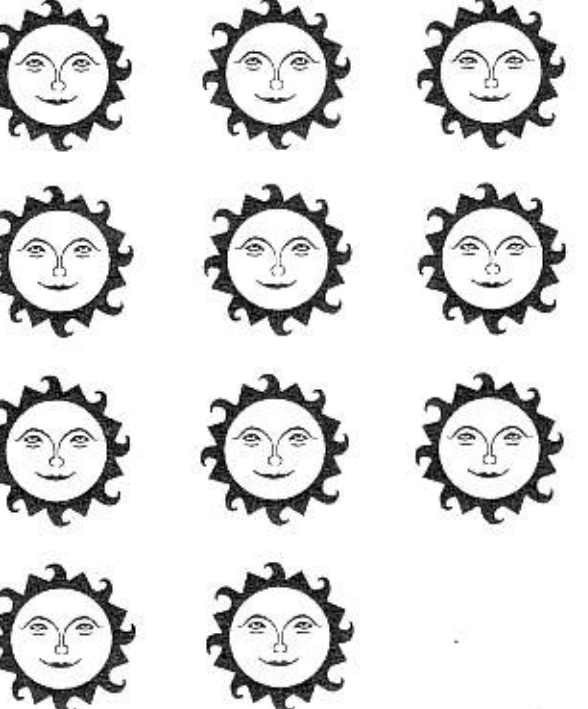
	 <p>၆</p>	 <p>၆</p>	 <p>၆</p>	 <p>၆</p>
---	--	---	--	--

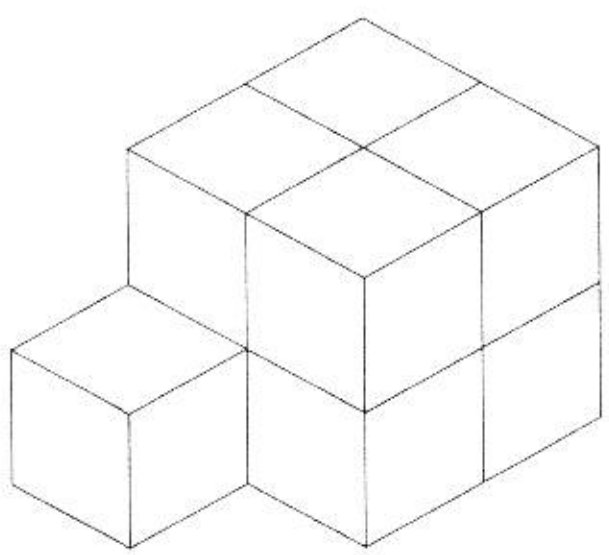
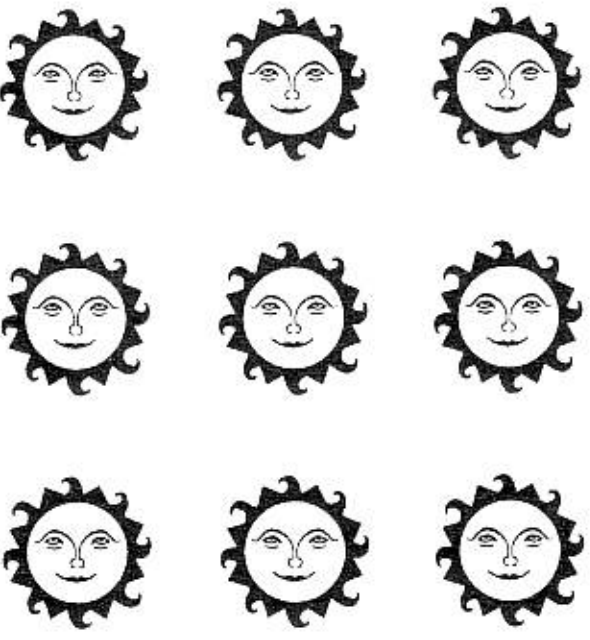
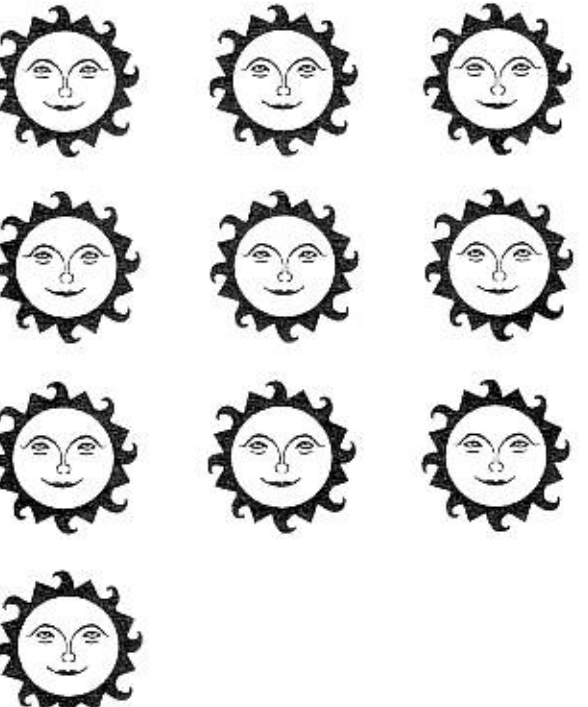
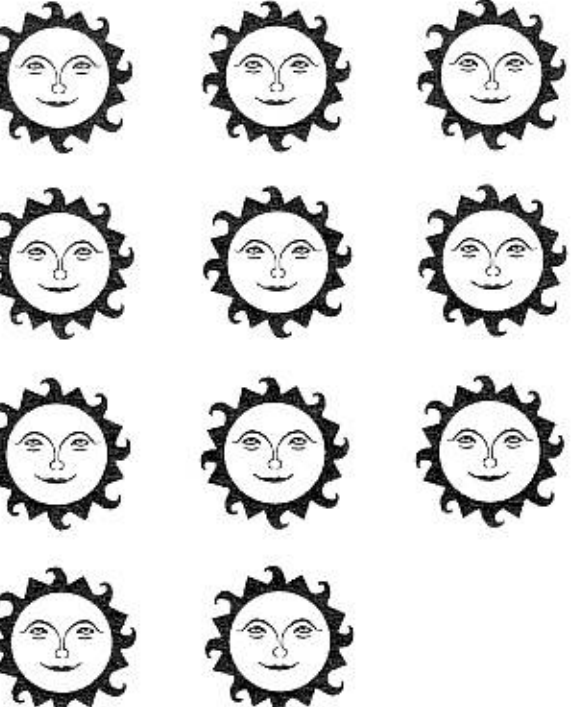
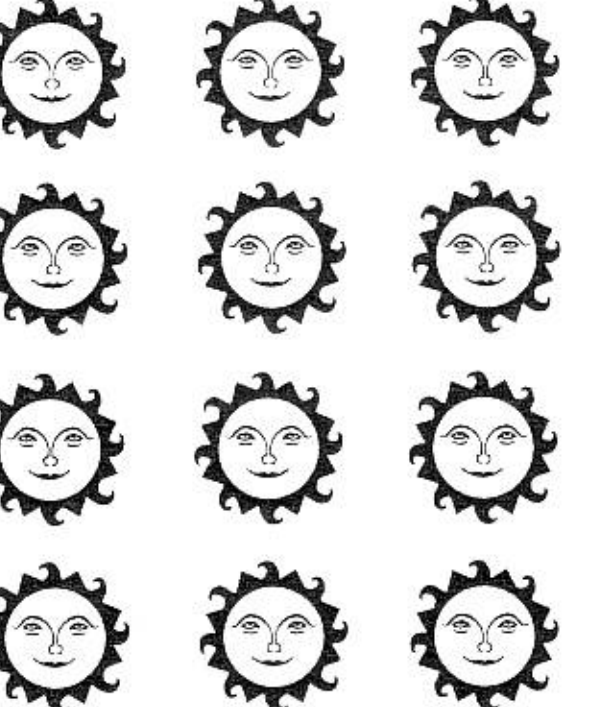

10

	 <p>၆</p>	 <p>၆</p>	 <p>၆</p>	 <p>၆</p>
---	--	---	--	--

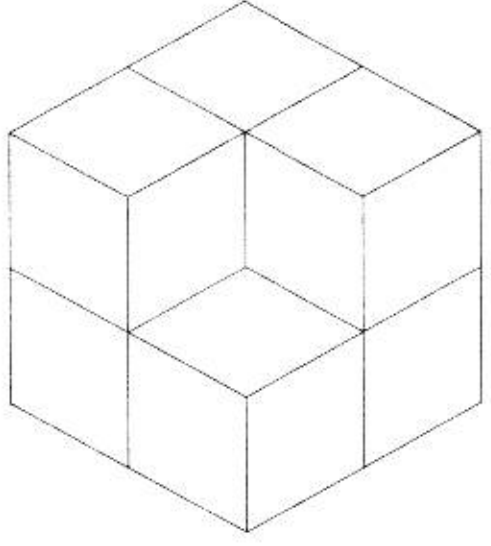
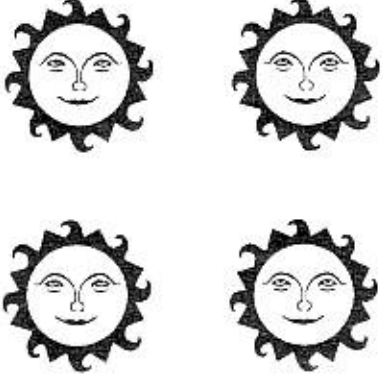
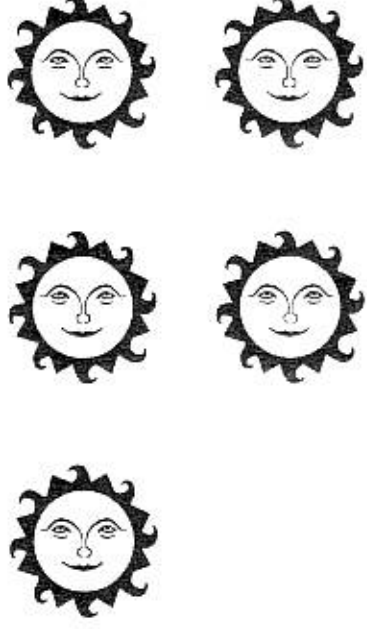
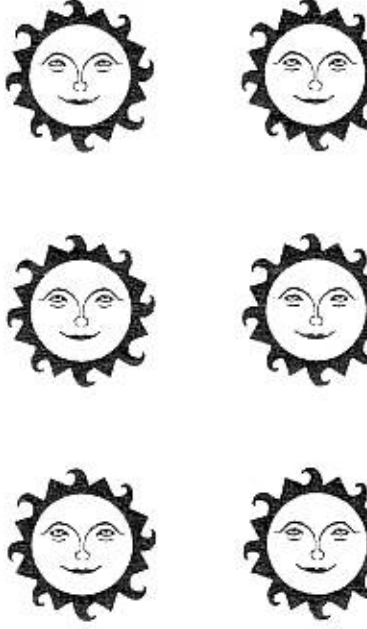
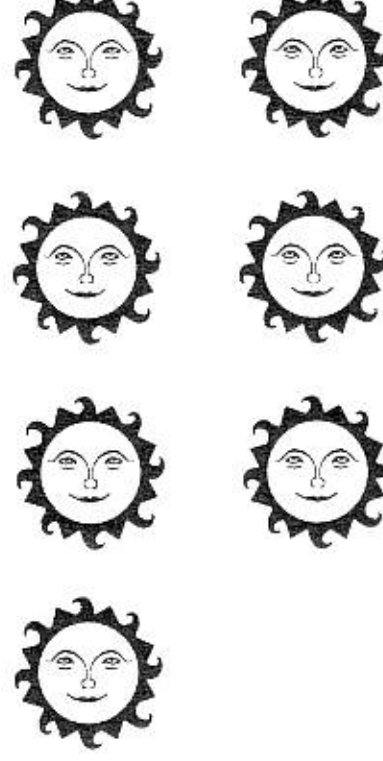

11

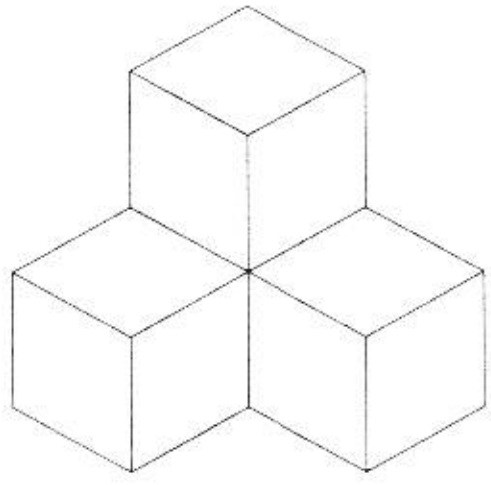
	 <p>၈</p>	 <p>၆</p>	 <p>၆</p>	 <p>၇</p>
---	--	---	--	--

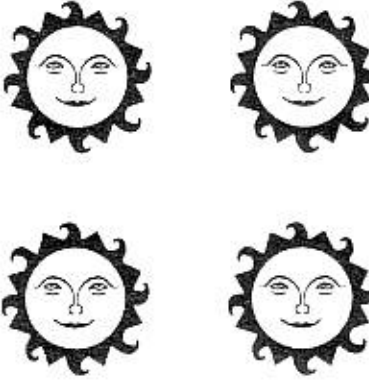
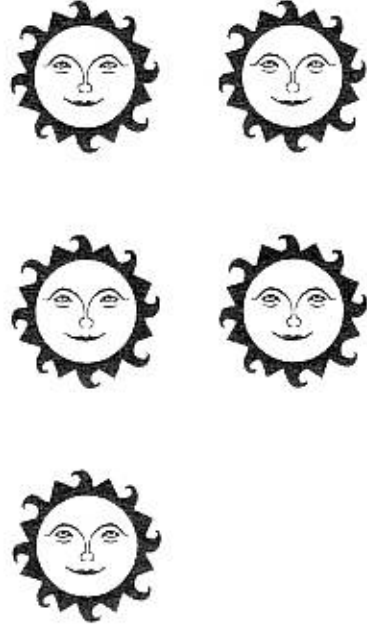
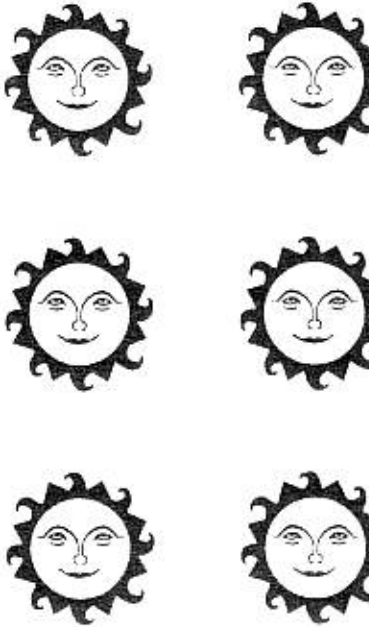
12

	 <p>၃</p>	 <p>၄</p>	 <p>၆</p>	 <p>၆</p>
--	---	--	---	---

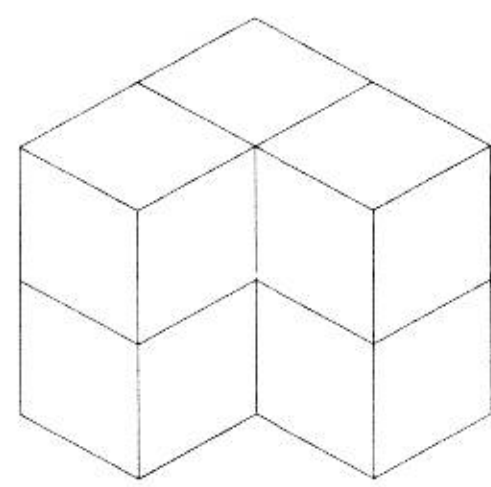
13

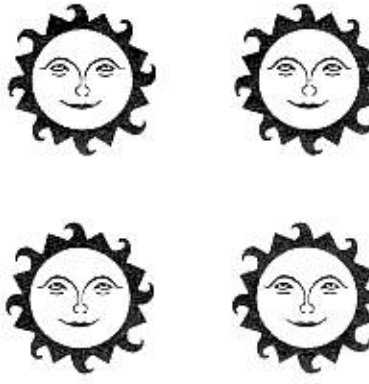
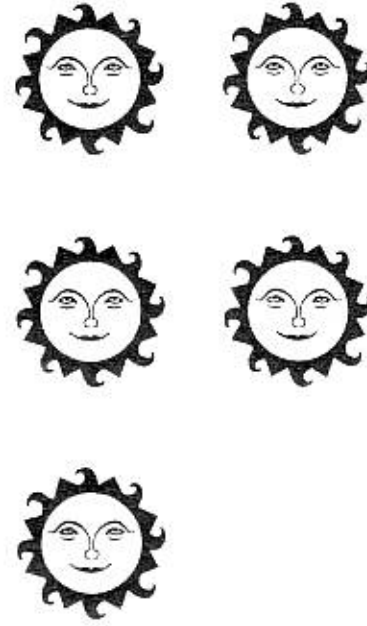
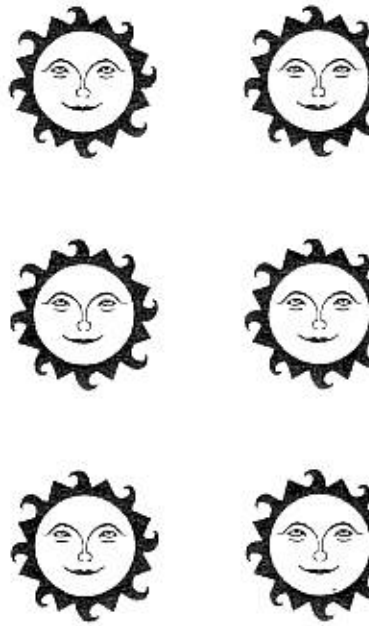
	 <p>၃</p>	 <p>၄</p>	 <p>၆</p>	 <p>၆</p>
---	--	---	--	--

14

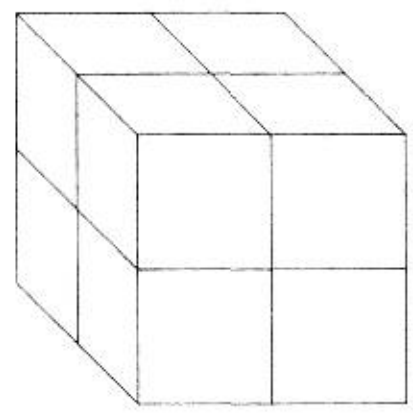
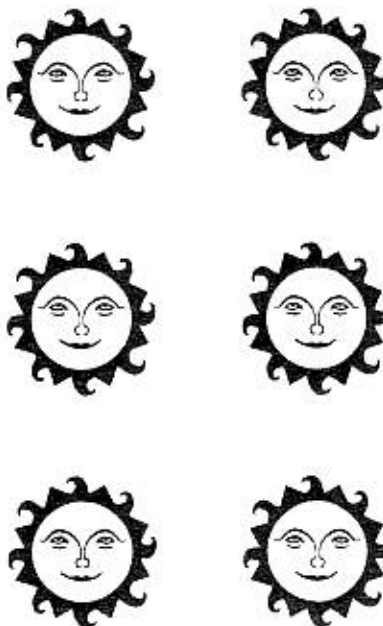
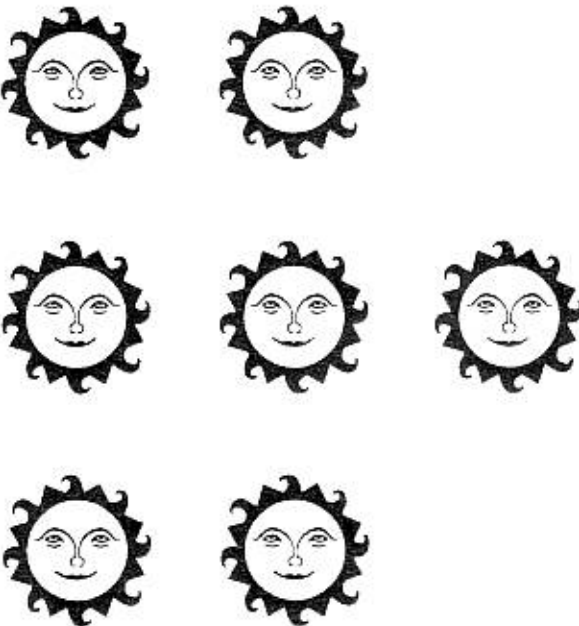
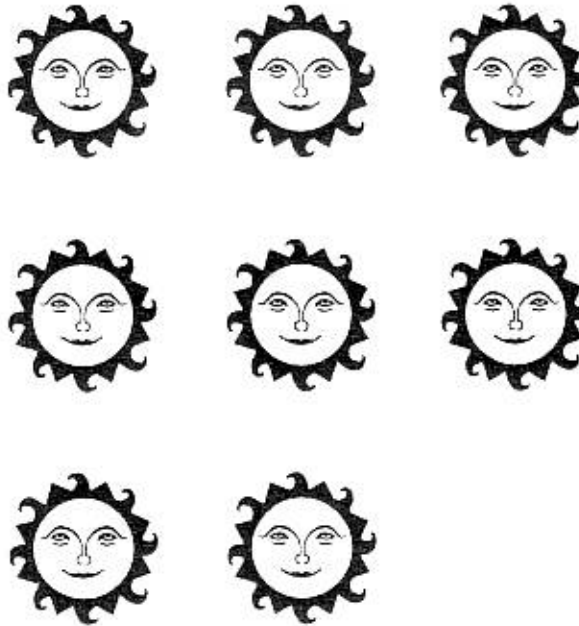
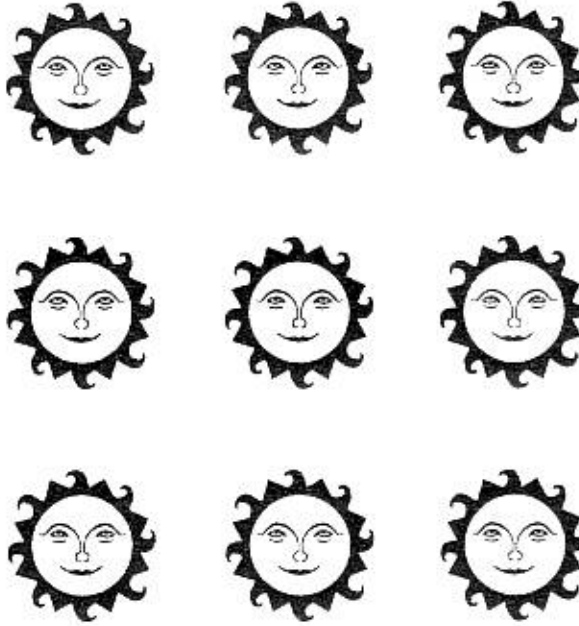
	 <p>၆</p>	 <p>၇</p>	 <p>၉</p>	 <p>၉</p>
---	--	---	--	--

15

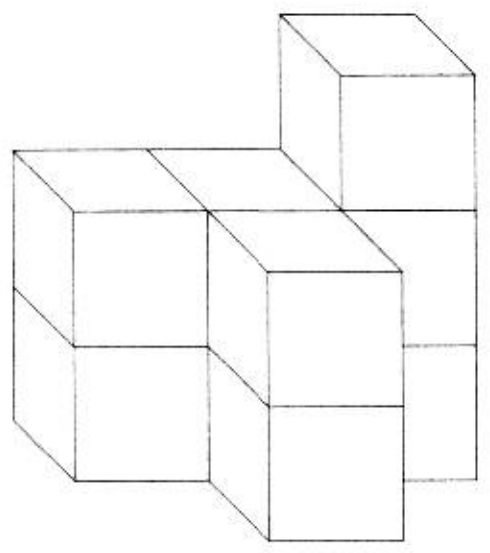
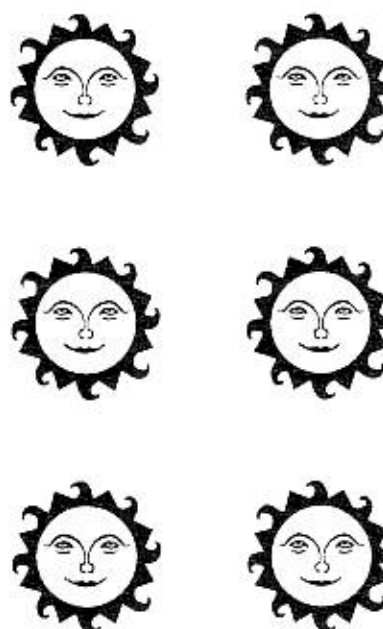
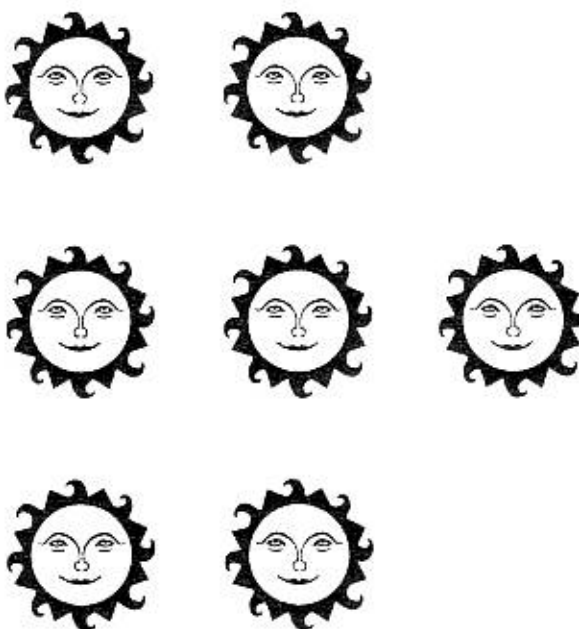
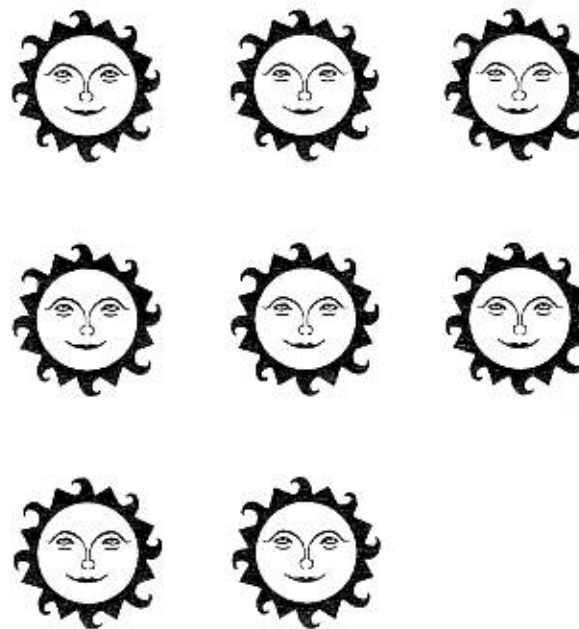
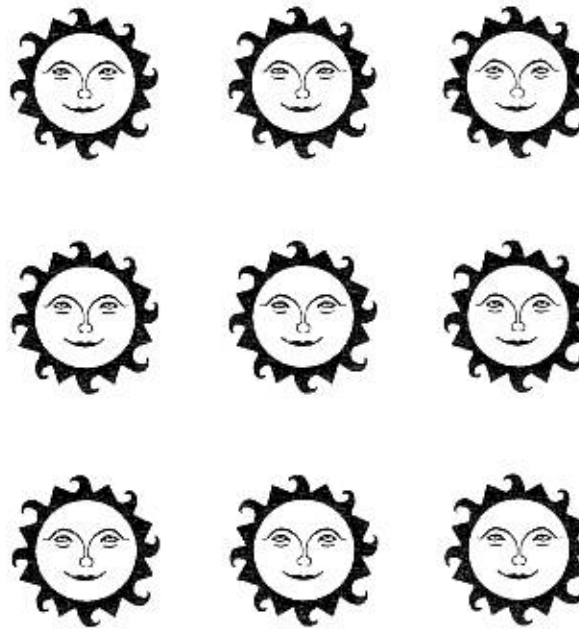
	 <p>၆</p>	 <p>၇</p>	 <p>၉</p>	 <p>၉</p>
---	--	---	--	--



16

	<p style="text-align: center;">၈</p>	<p style="text-align: center;">၉</p>	<p style="text-align: center;">၁၀</p>	<p style="text-align: center;">၁၁</p>
--	--------------------------------------	--------------------------------------	---------------------------------------	---------------------------------------

17

	<p style="text-align: center;">၈</p>	<p style="text-align: center;">၉</p>	<p style="text-align: center;">၁၀</p>	<p style="text-align: center;">၁၁</p>
--	--------------------------------------	--------------------------------------	---------------------------------------	---------------------------------------

18

	<p style="text-align: center;">၉</p>	<p style="text-align: center;">၁၂</p>	<p style="text-align: center;">၁၃</p>	<p style="text-align: center;">၁၄</p>
--	--------------------------------------	---------------------------------------	---------------------------------------	---------------------------------------

19

	<p style="text-align: center;">၉</p>	<p style="text-align: center;">၁၂</p>	<p style="text-align: center;">၁၃</p>	<p style="text-align: center;">၁၄</p>
--	--------------------------------------	---------------------------------------	---------------------------------------	---------------------------------------

20

	<p style="text-align: center;">၉</p>	<p style="text-align: center;">၁၂</p>	<p style="text-align: center;">၁၃</p>	<p style="text-align: center;">၁၄</p>
--	--------------------------------------	---------------------------------------	---------------------------------------	---------------------------------------

จงขีด ✓ ข้อที่มีจำนวนเท่ากับภาพในช่องแรก

1

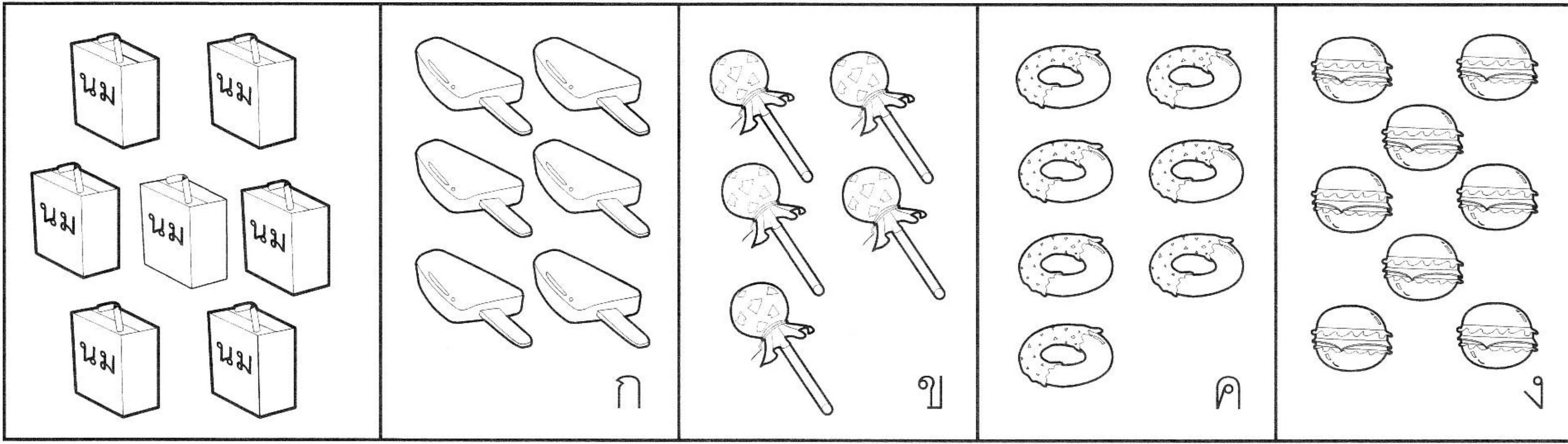

2

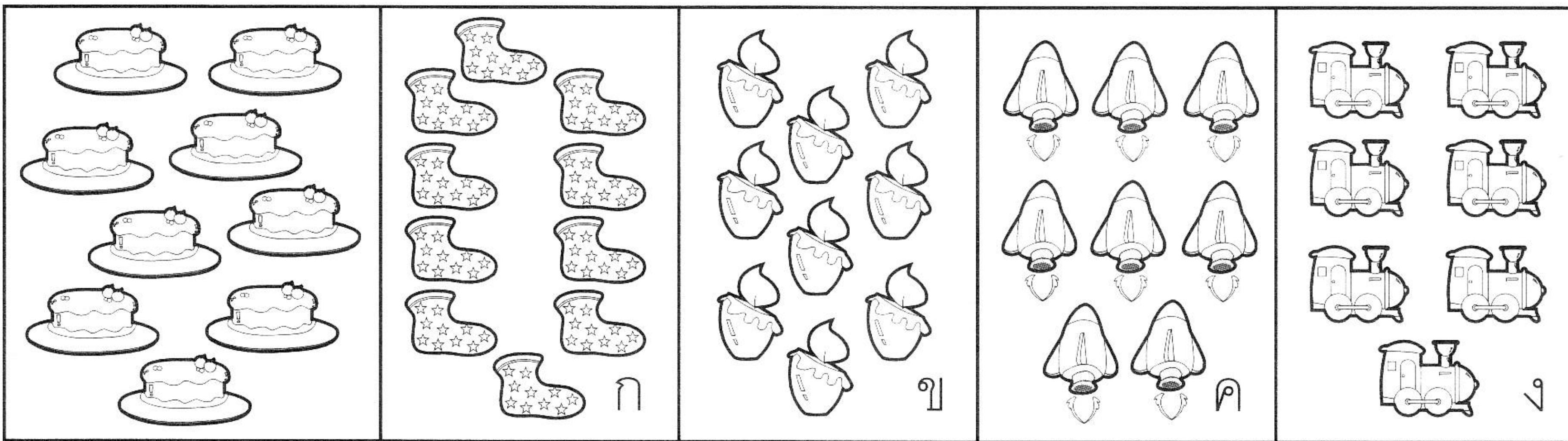

3

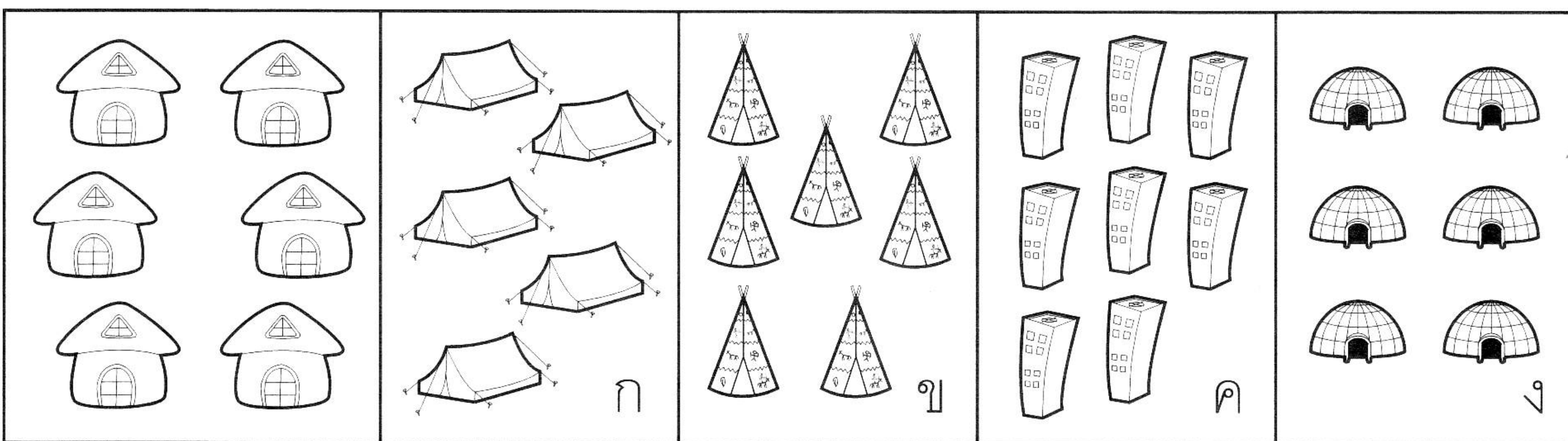

4

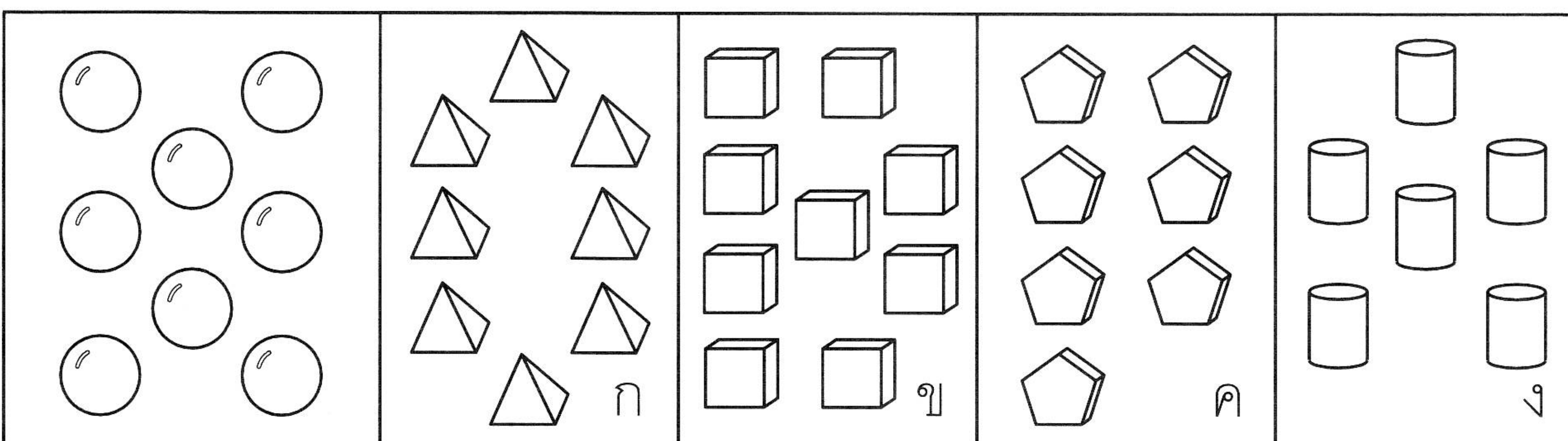

5

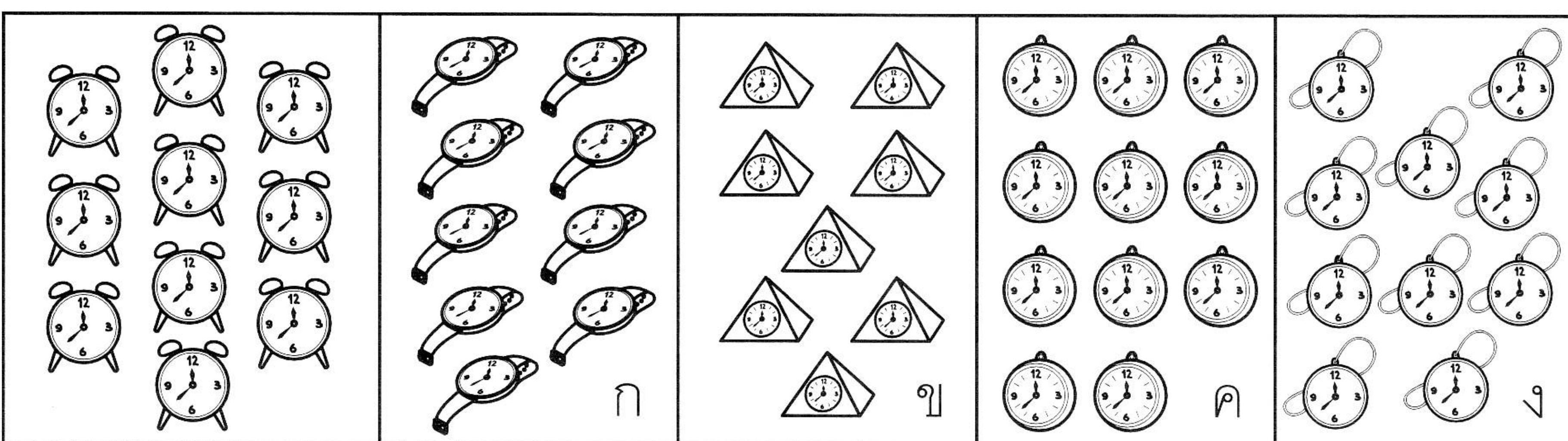

6

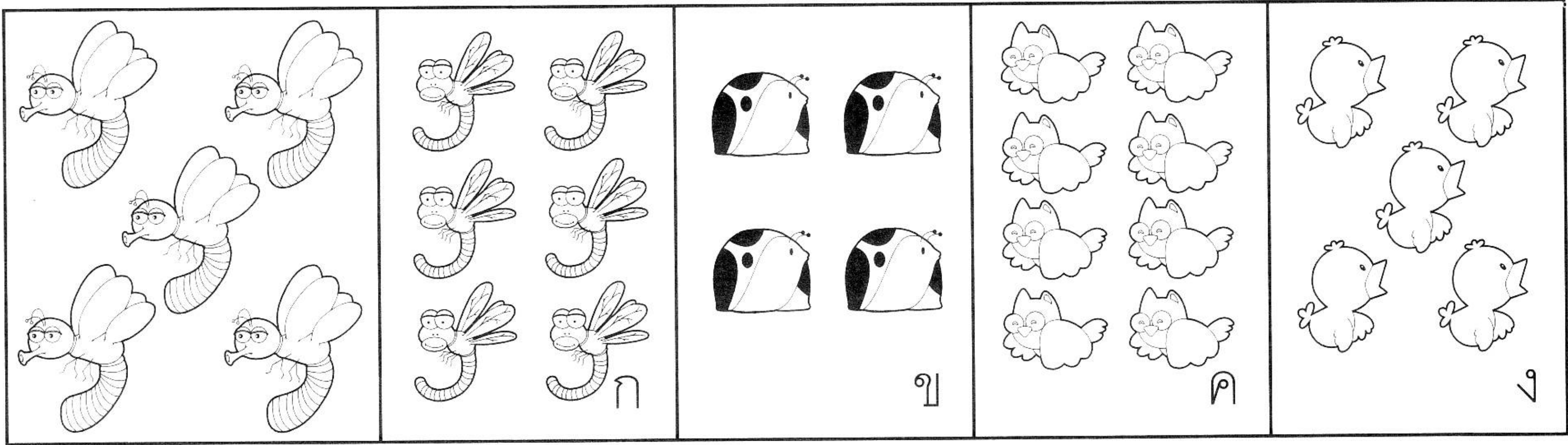

7

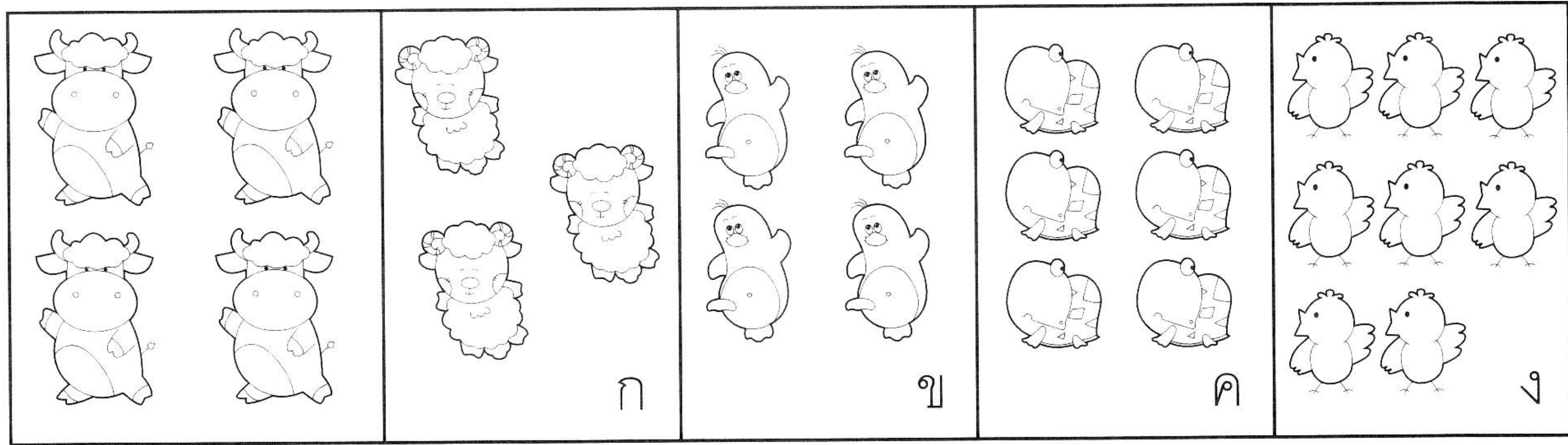

8

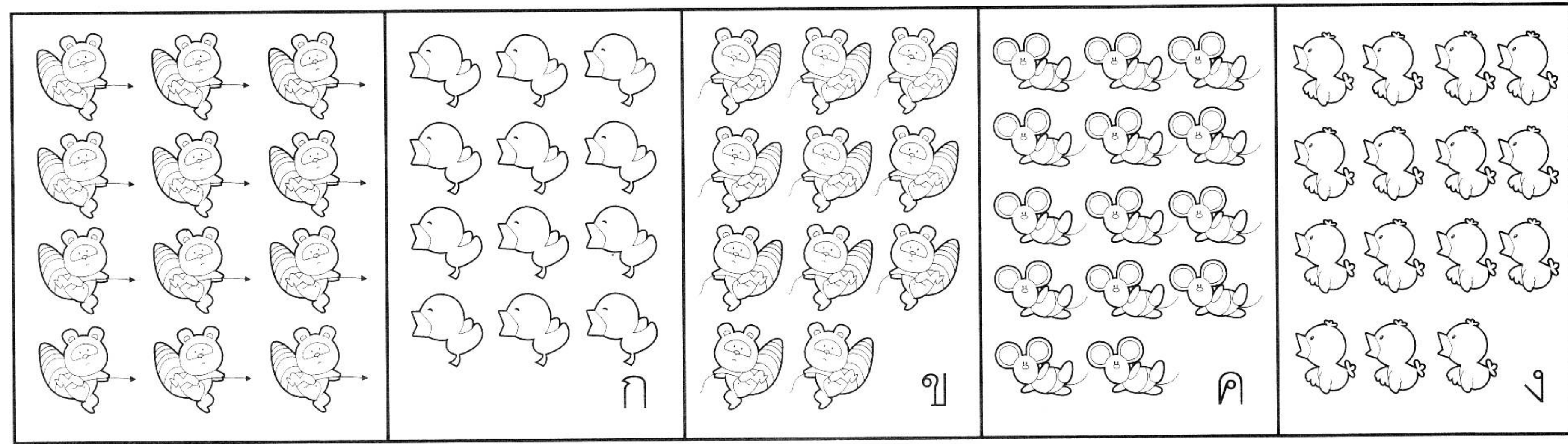

9

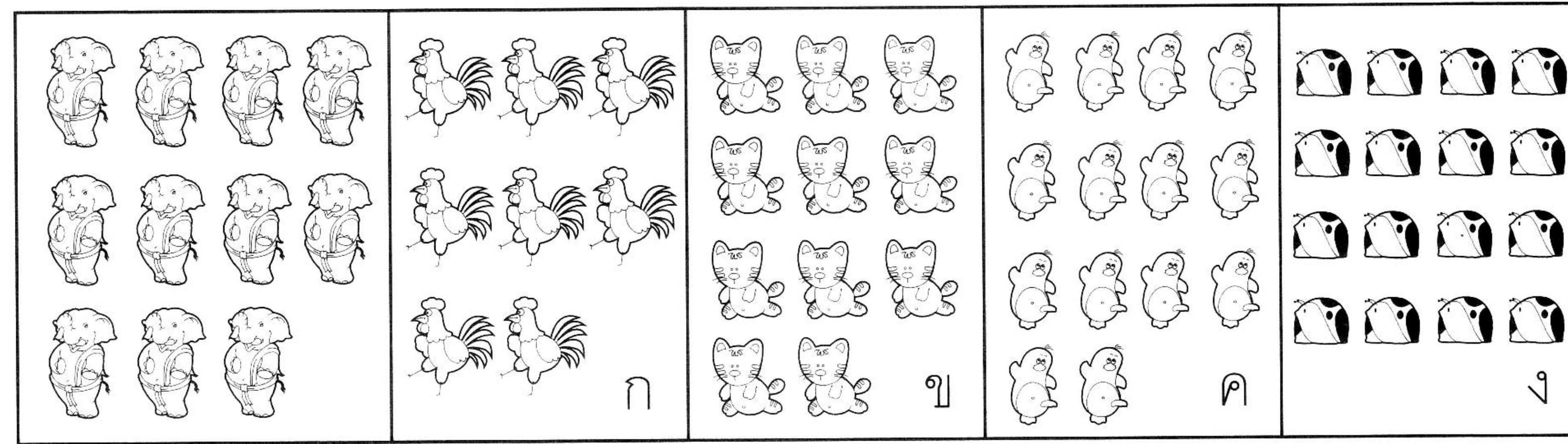

10

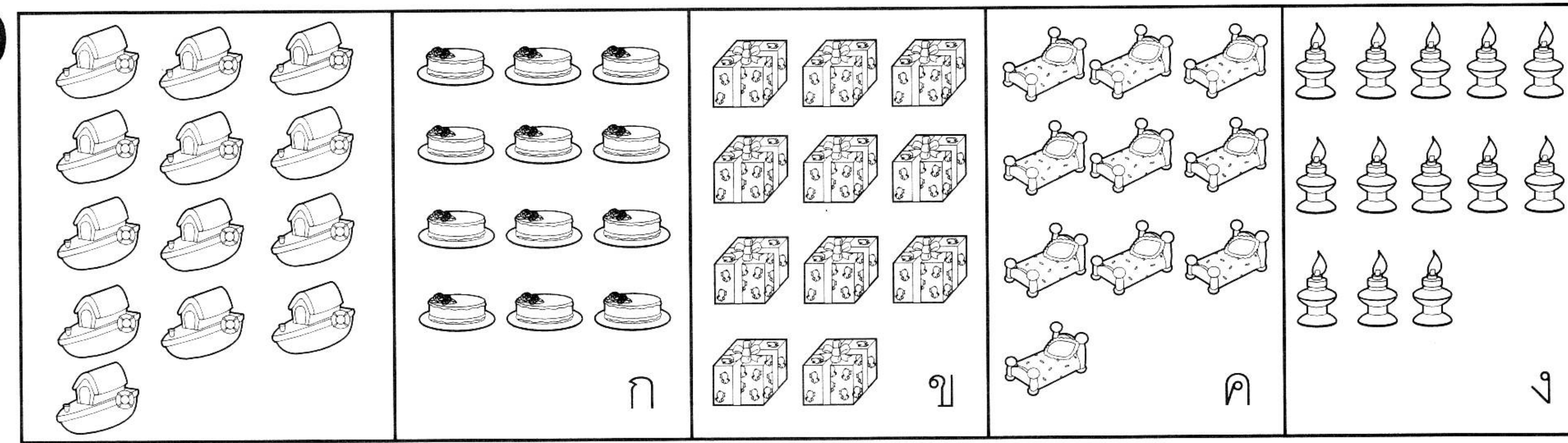

จง ○ ข้อที่มีจำนวนมากกว่าภาพในช่องแรก

1

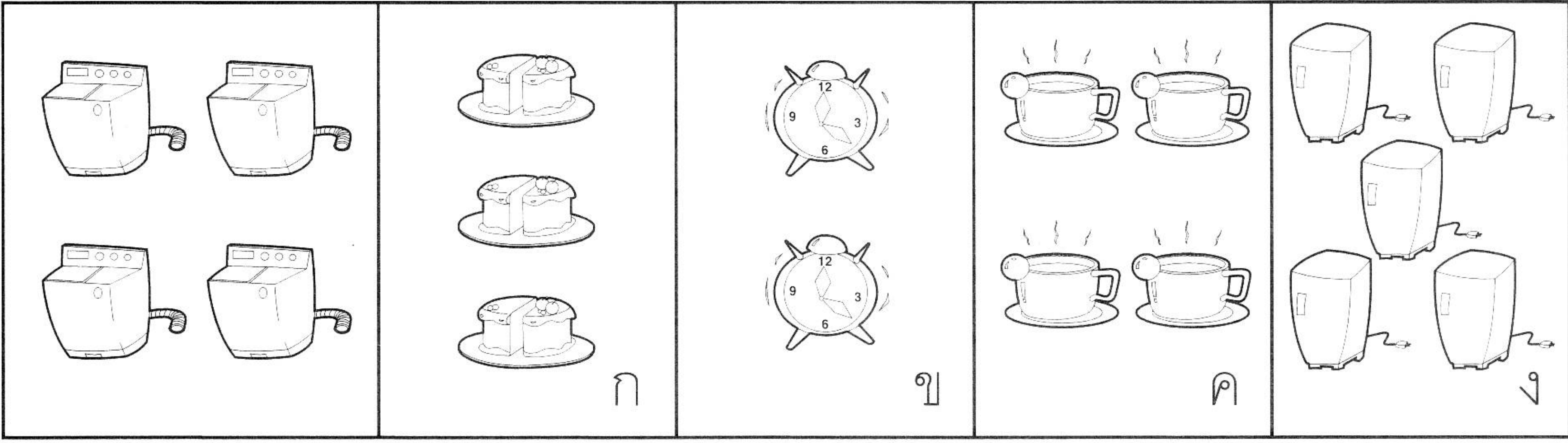

2

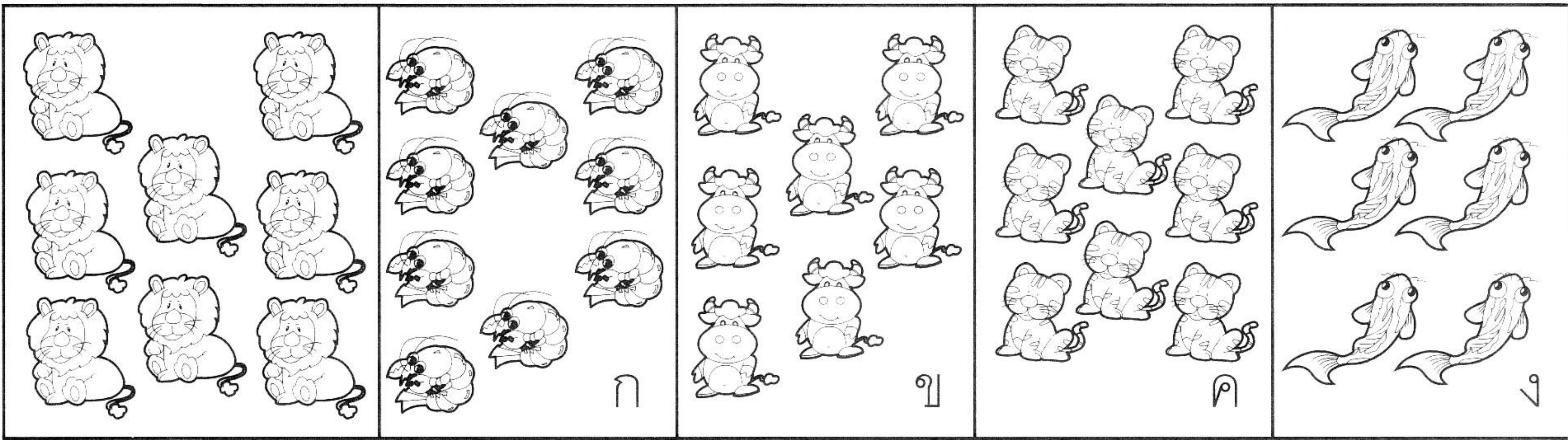

3

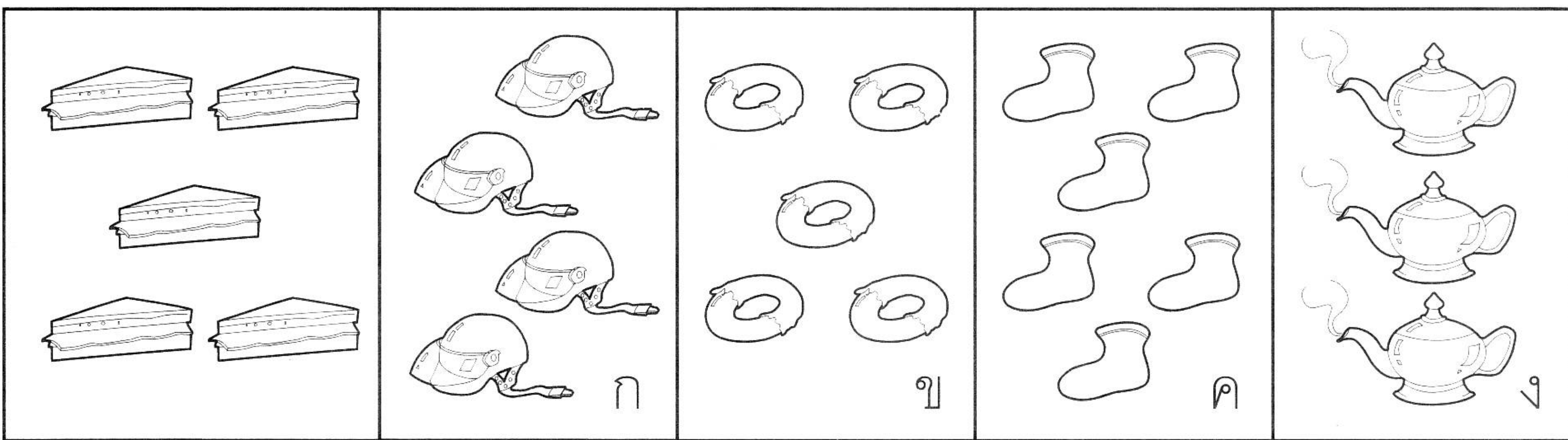

4

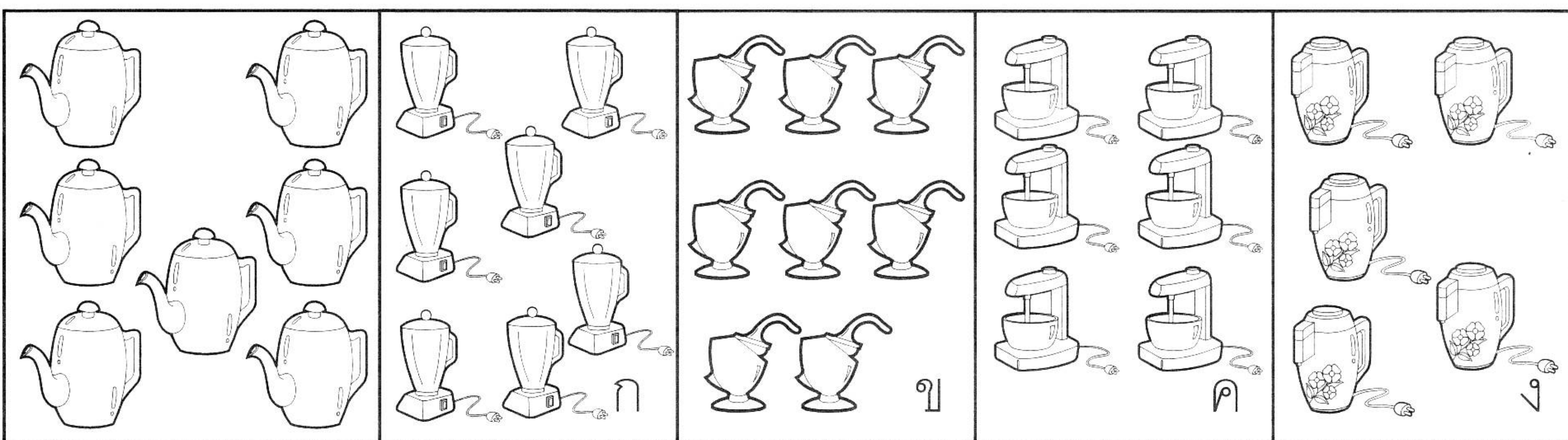

5

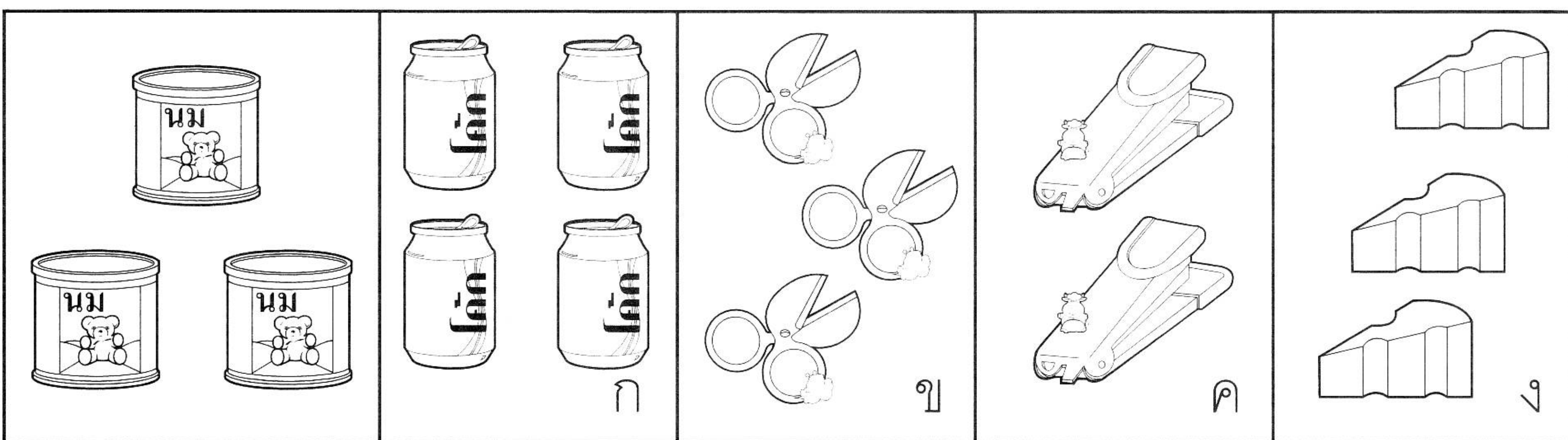

6

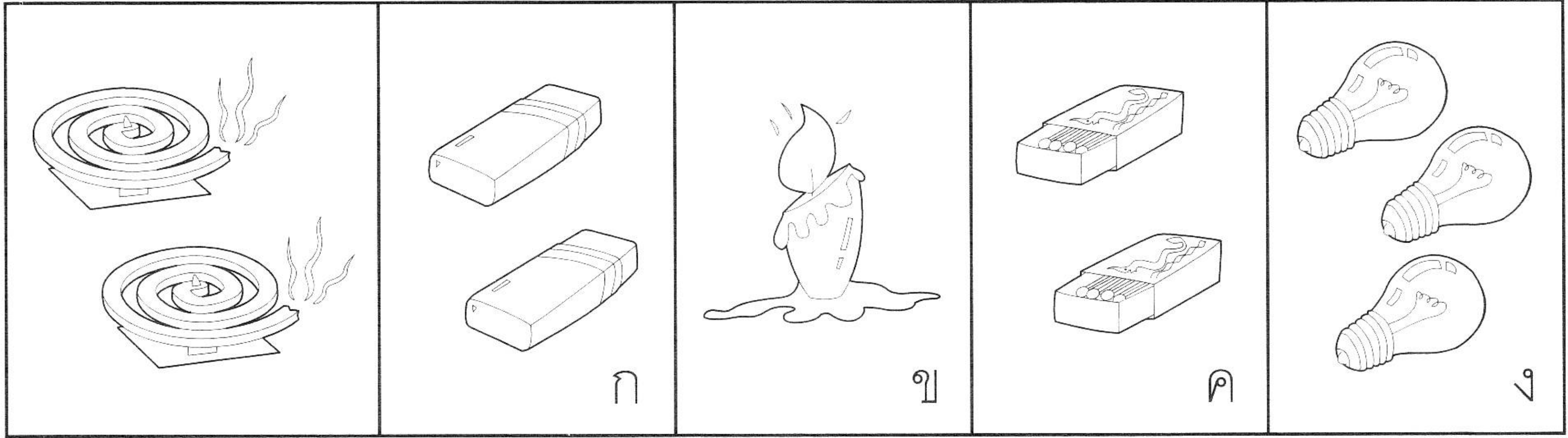

7

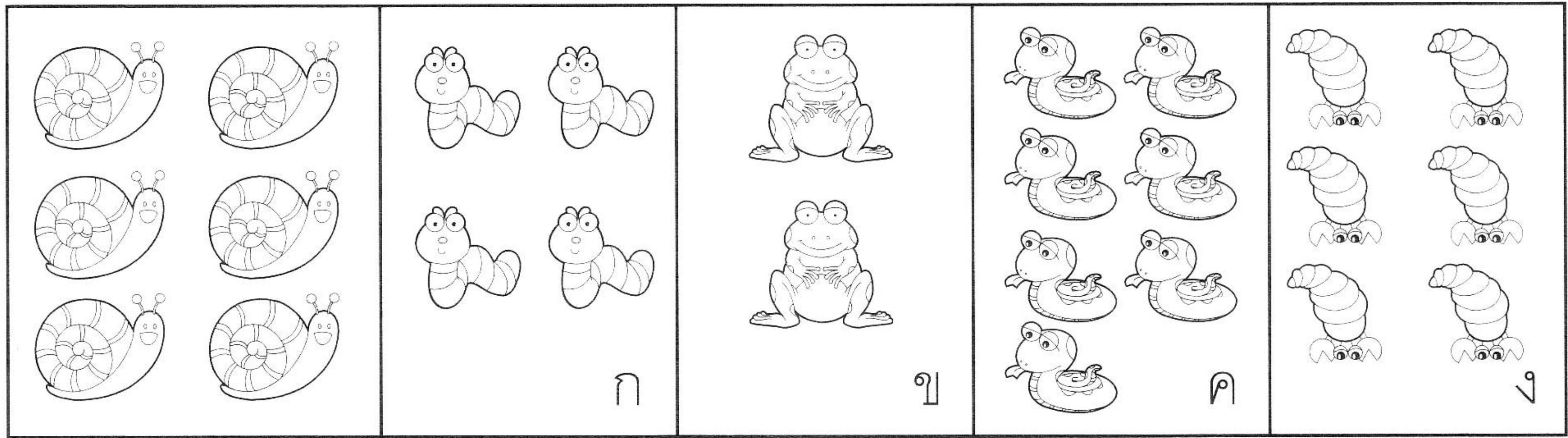

8

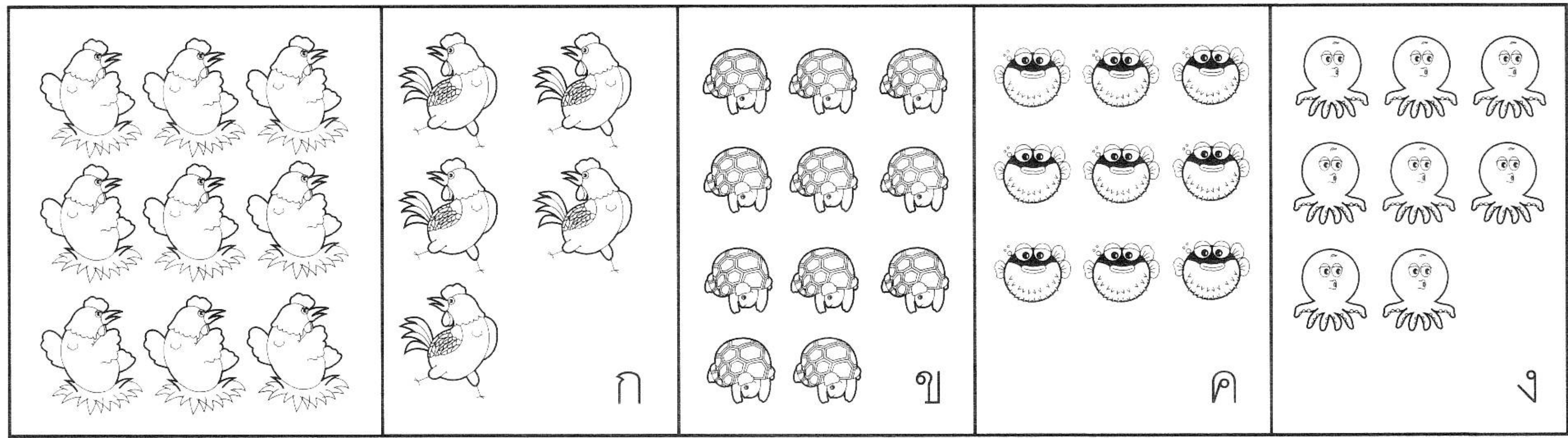

9

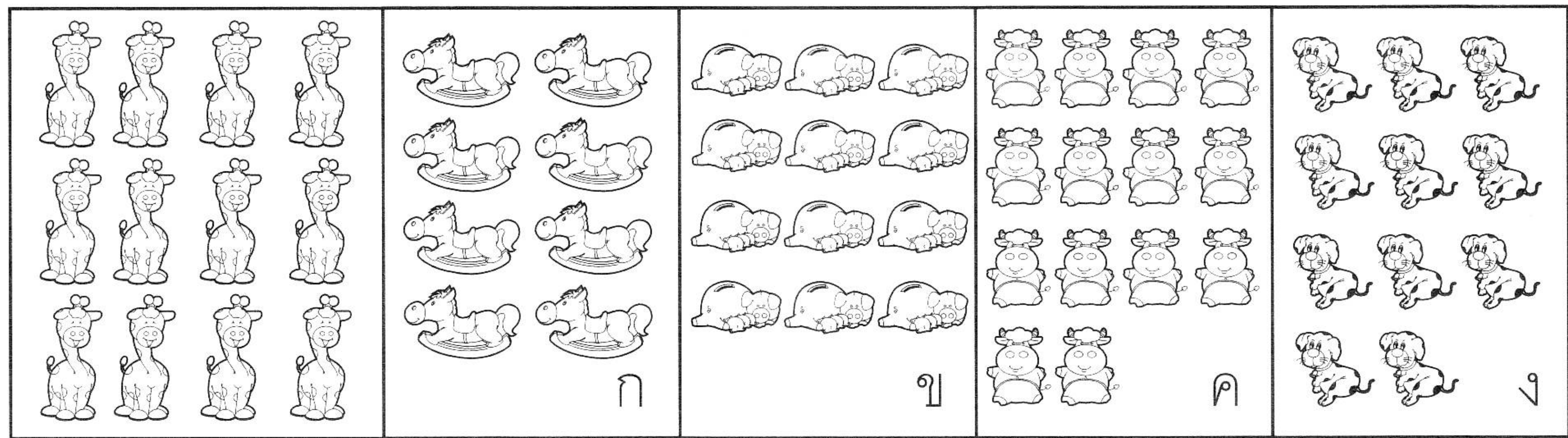

10

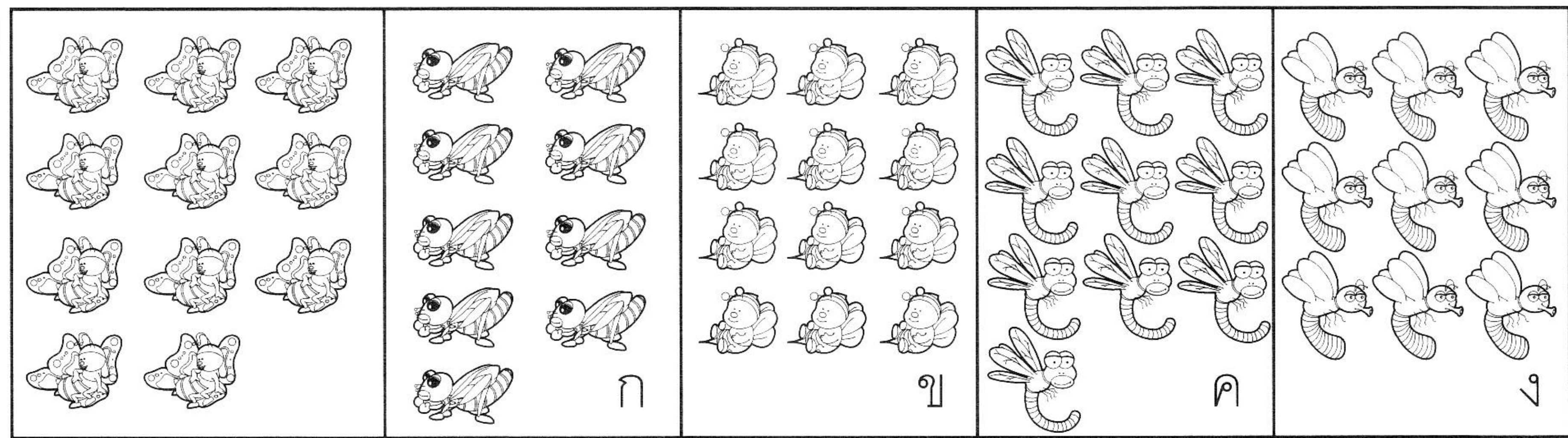

จงขีด ✓ ข้อที่มีจำนวนน้อยกว่าภาพในช่องแรก

1

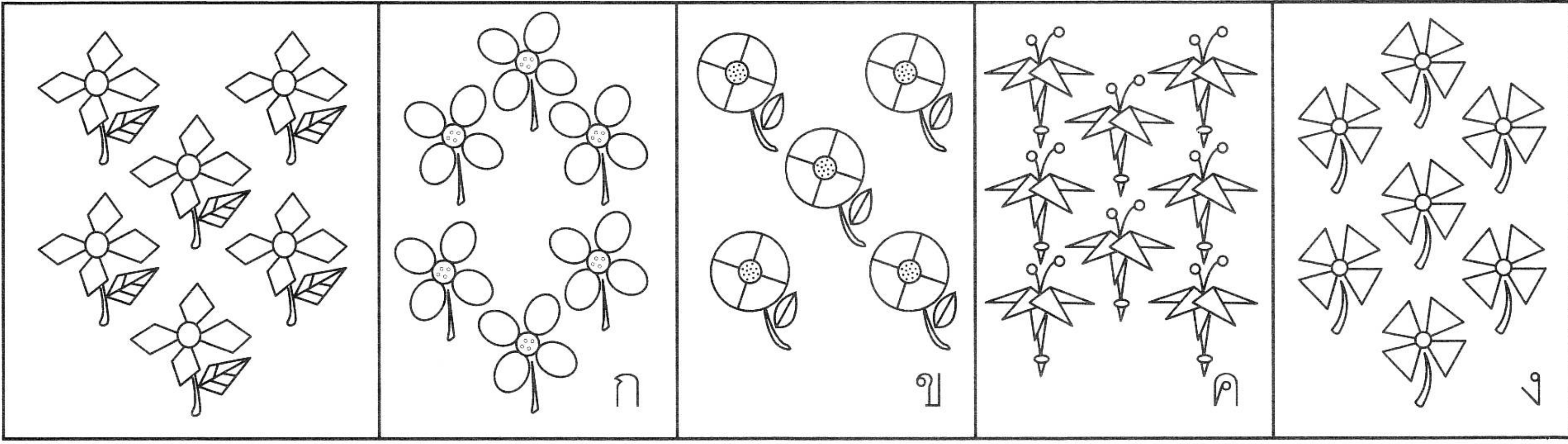

2

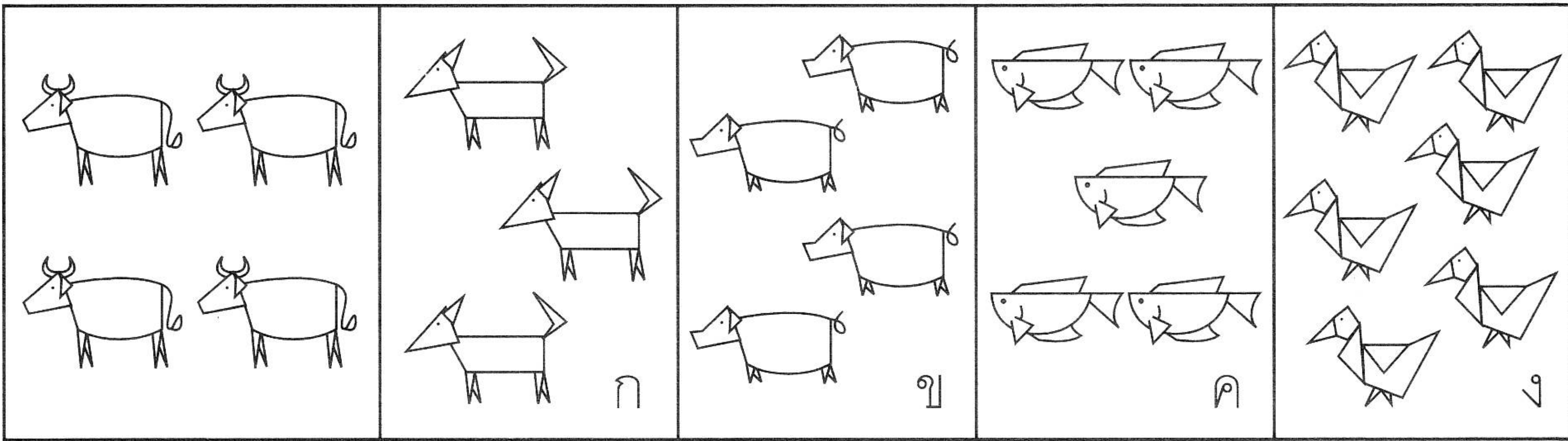

3

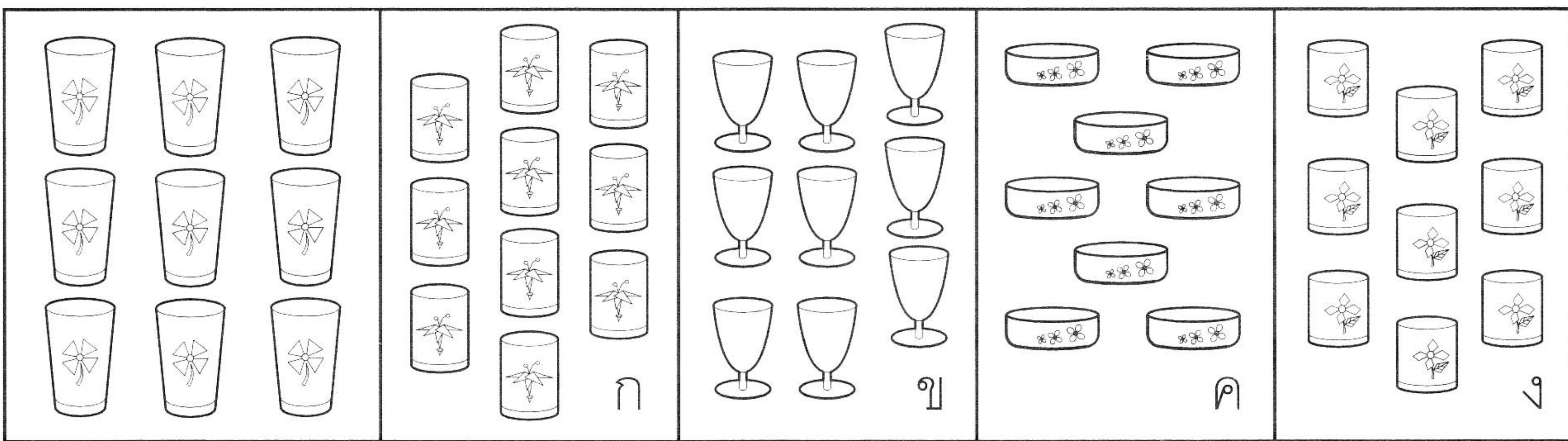

4

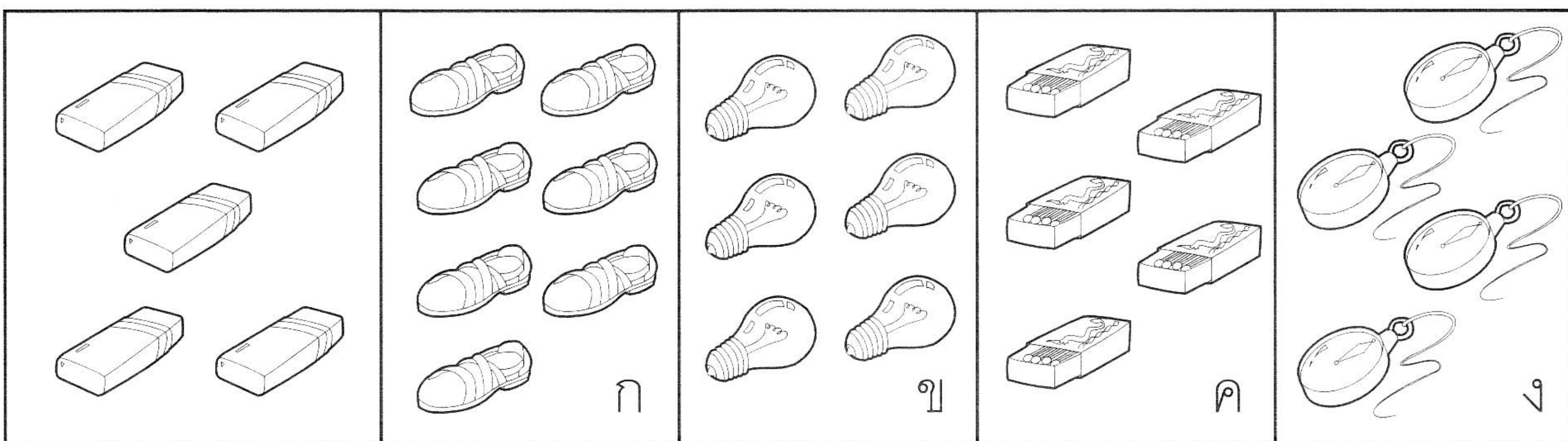

5

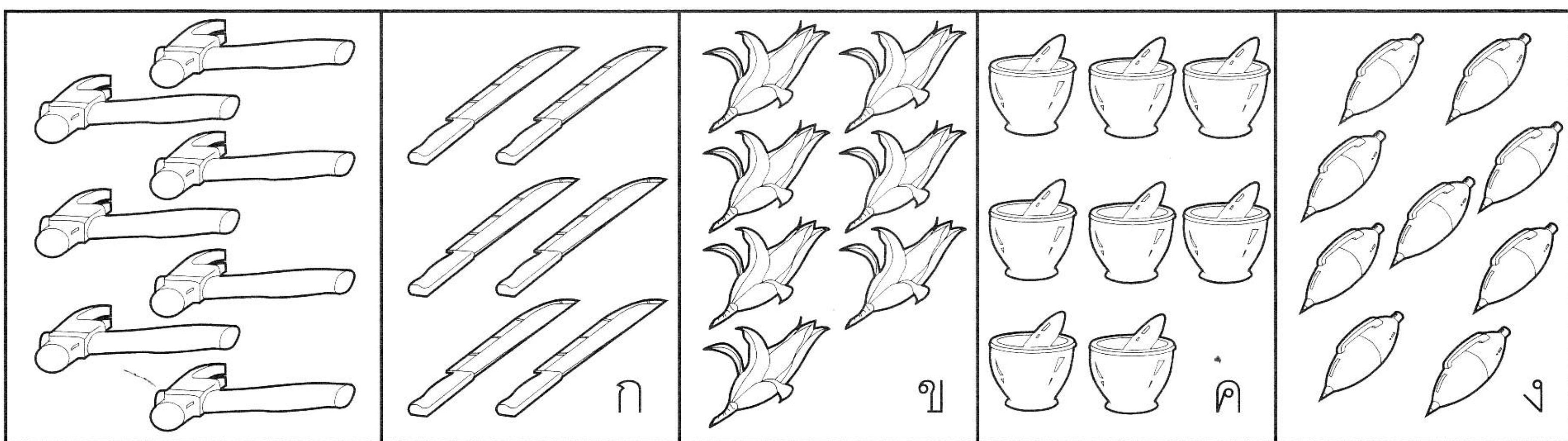

6

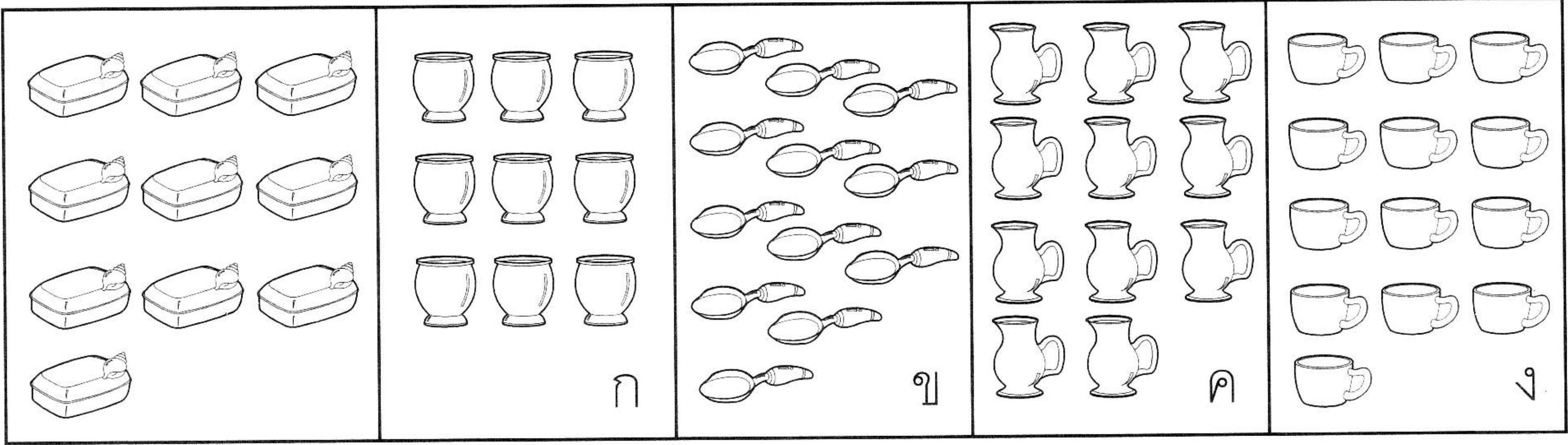

7

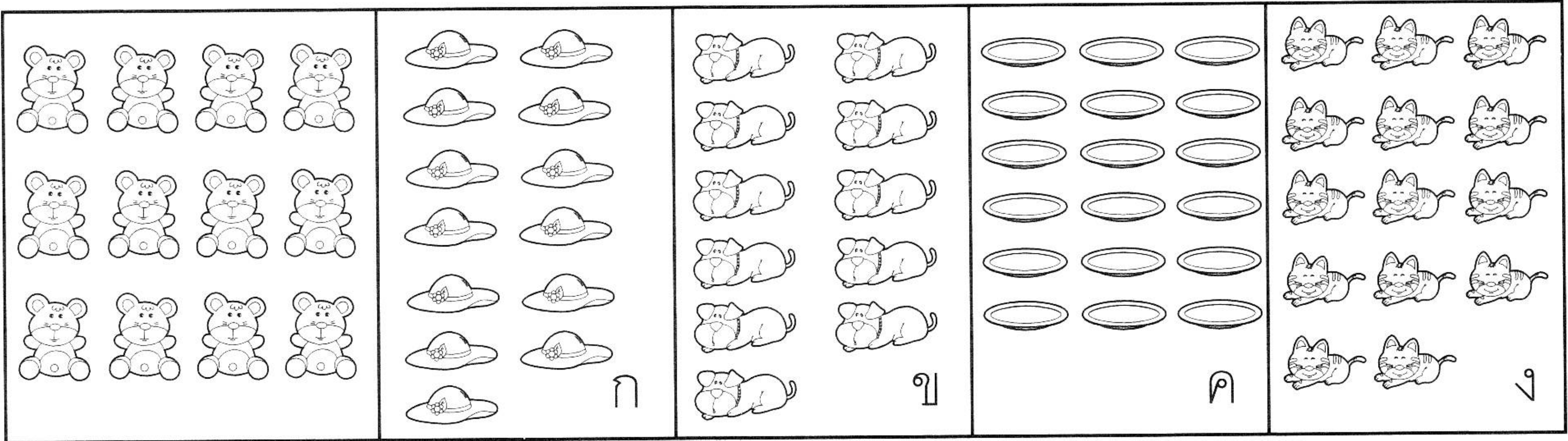

8

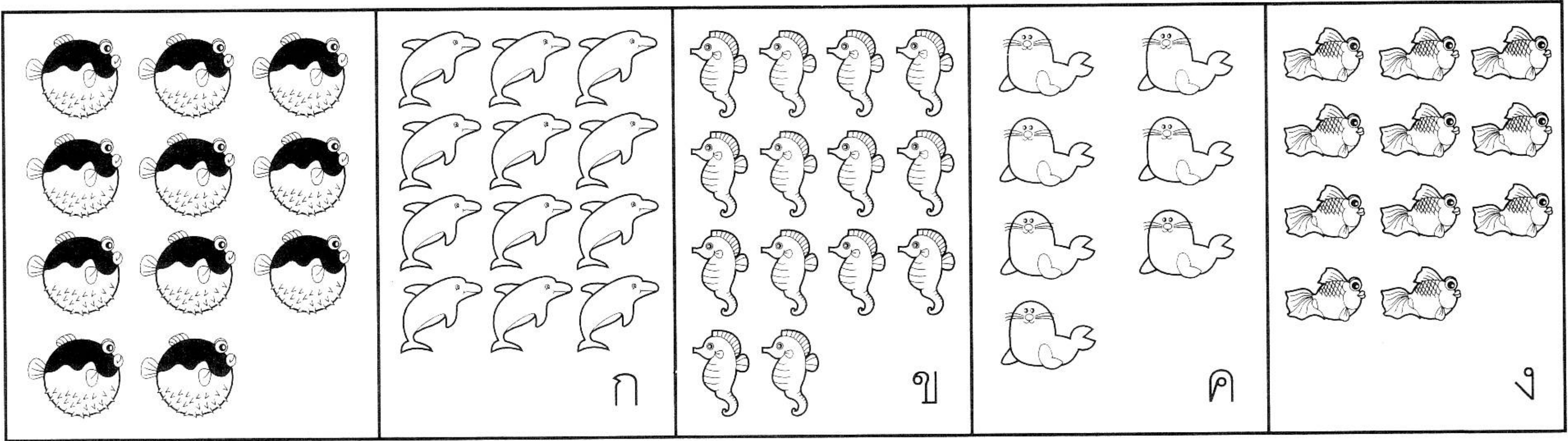

9

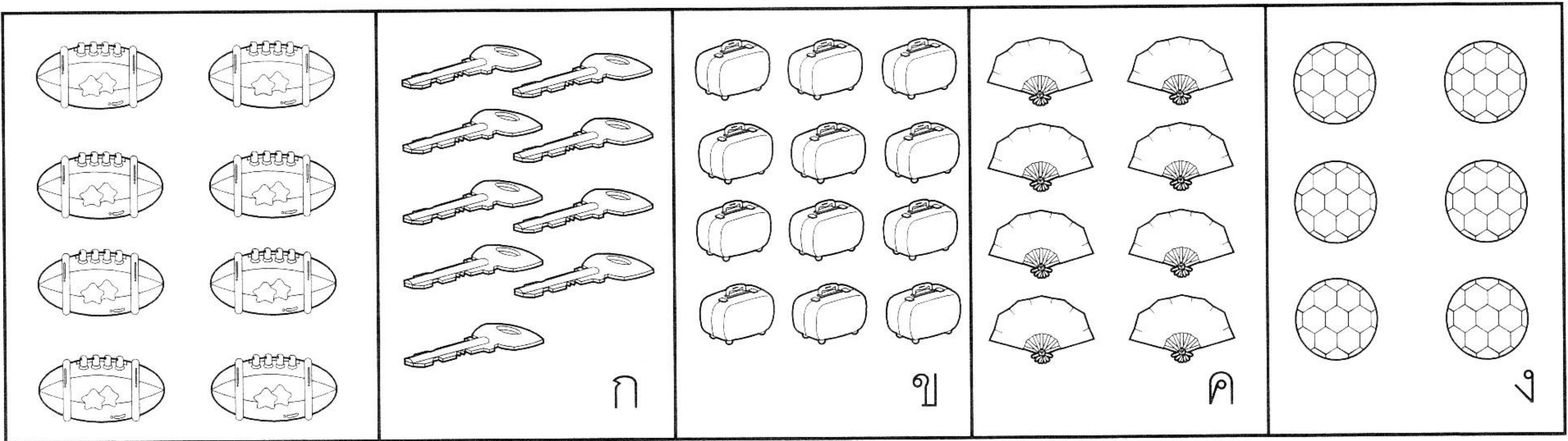

10

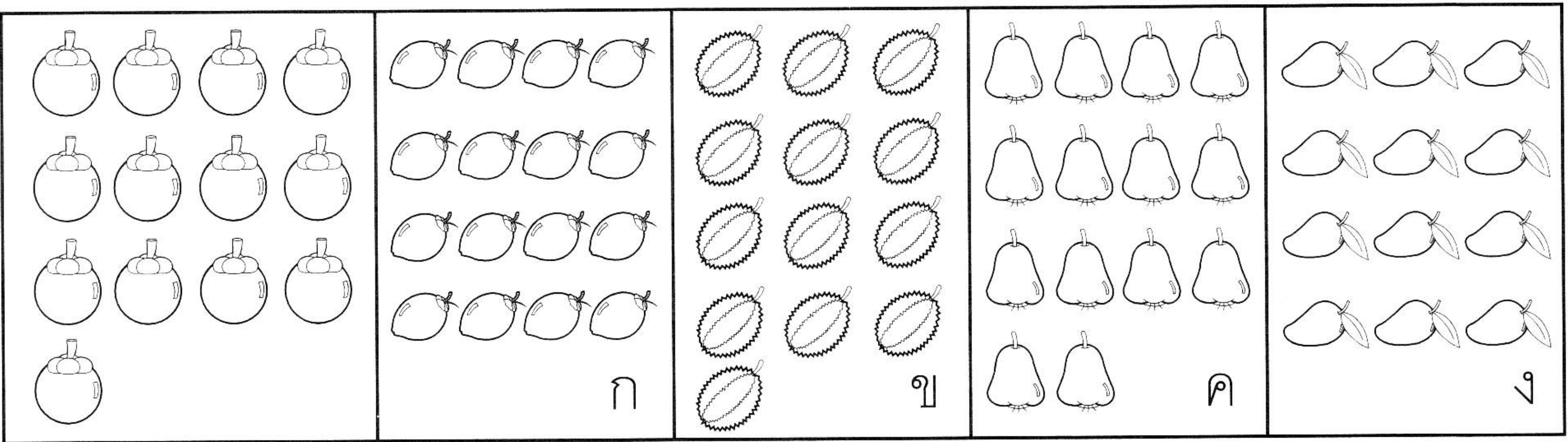

จงขีด ✕ ข้อที่มีจำนวนใกล้เคียงกับภาพในช่องแรก

1

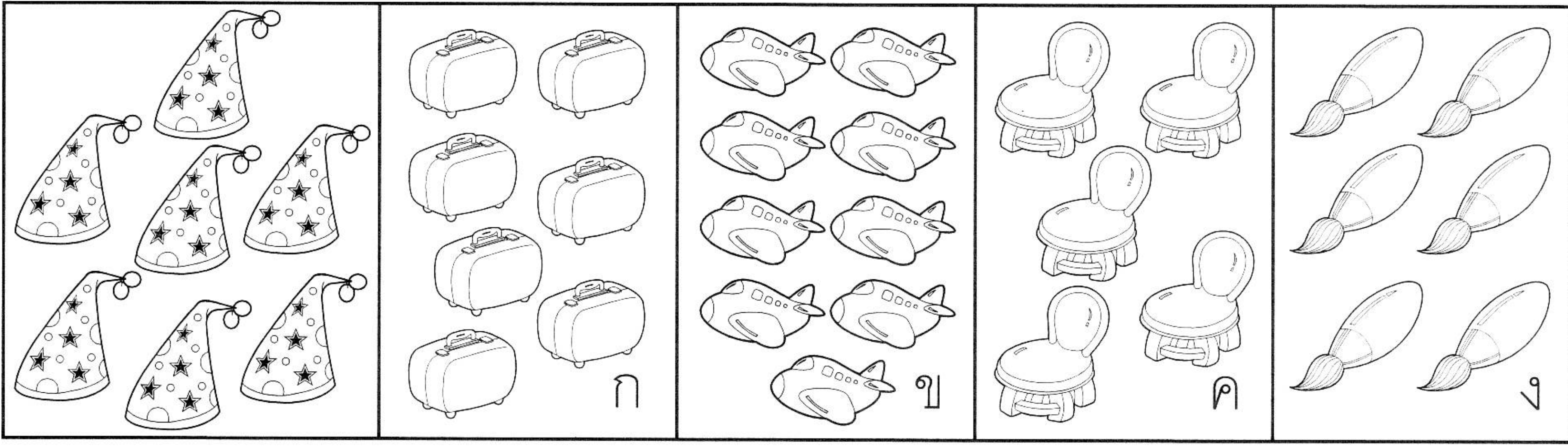

2

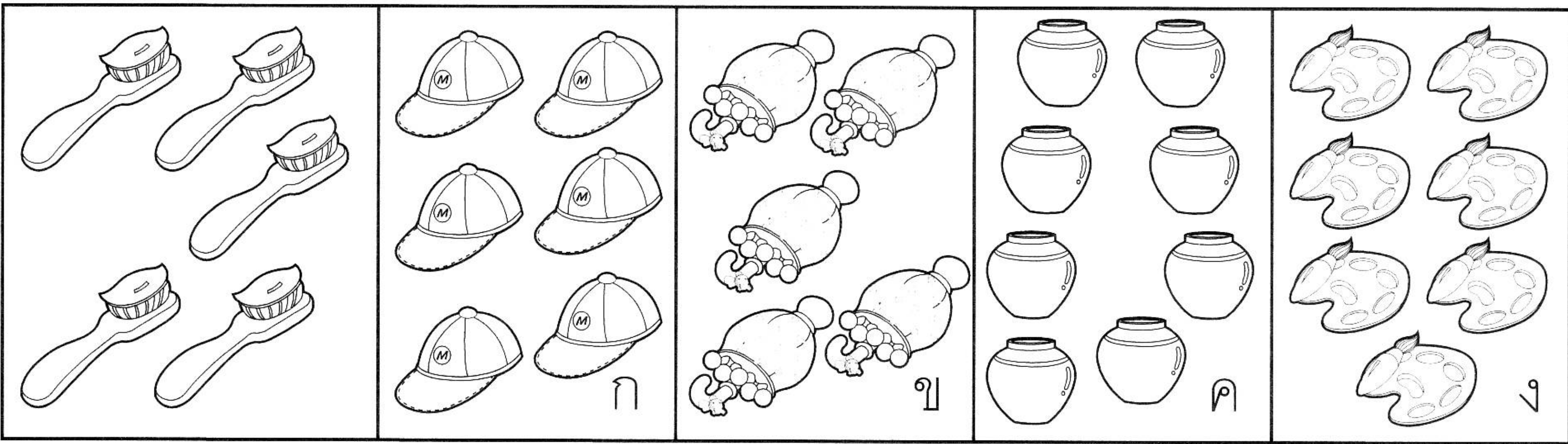

3

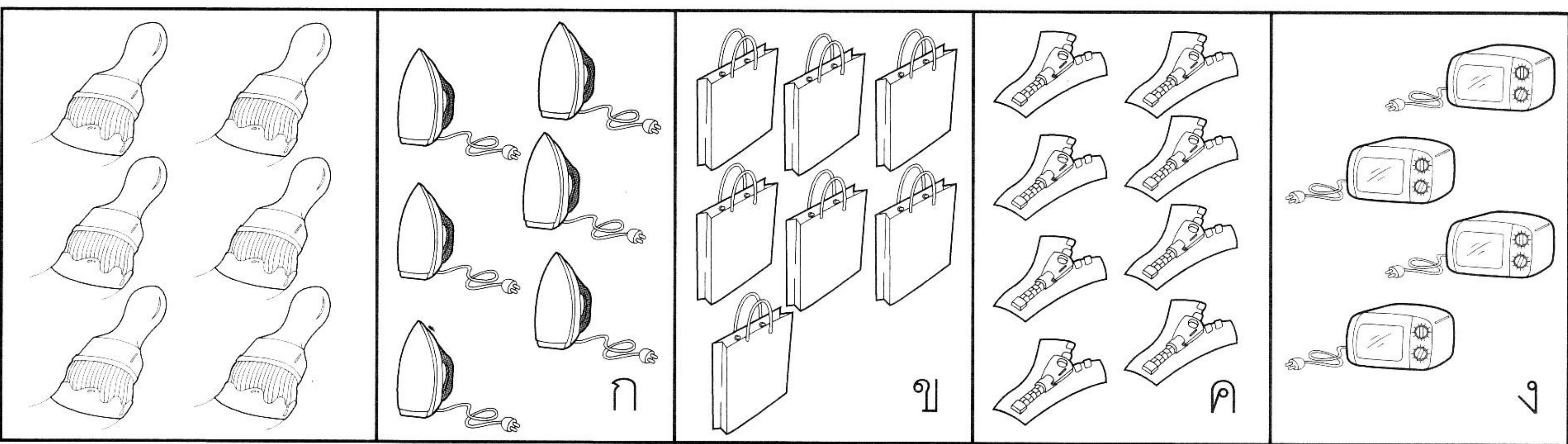

4

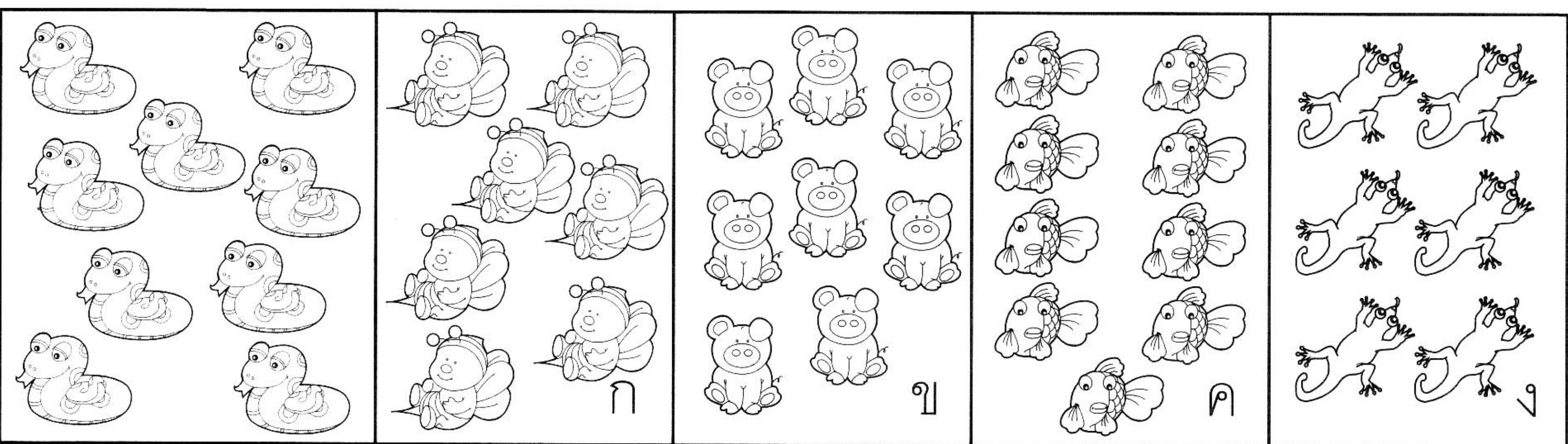

5

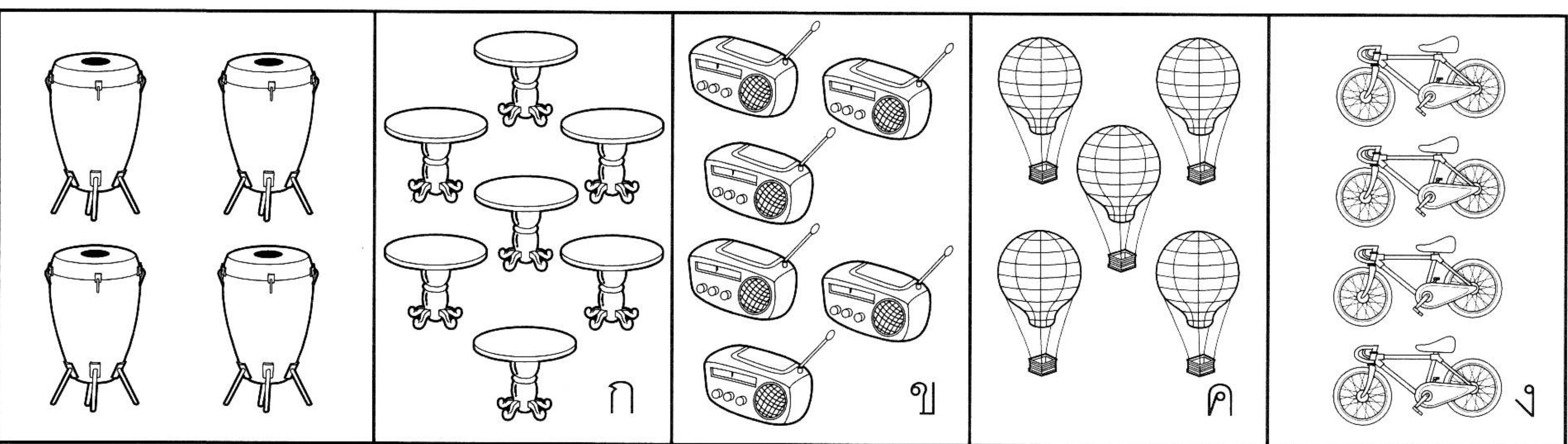

6

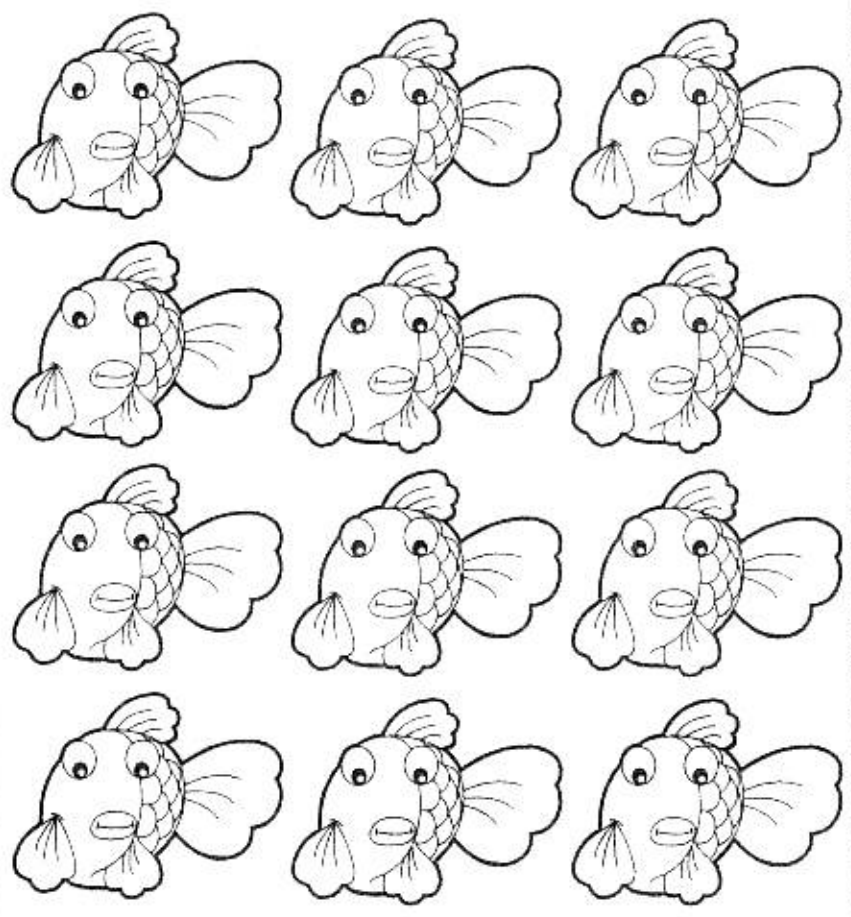
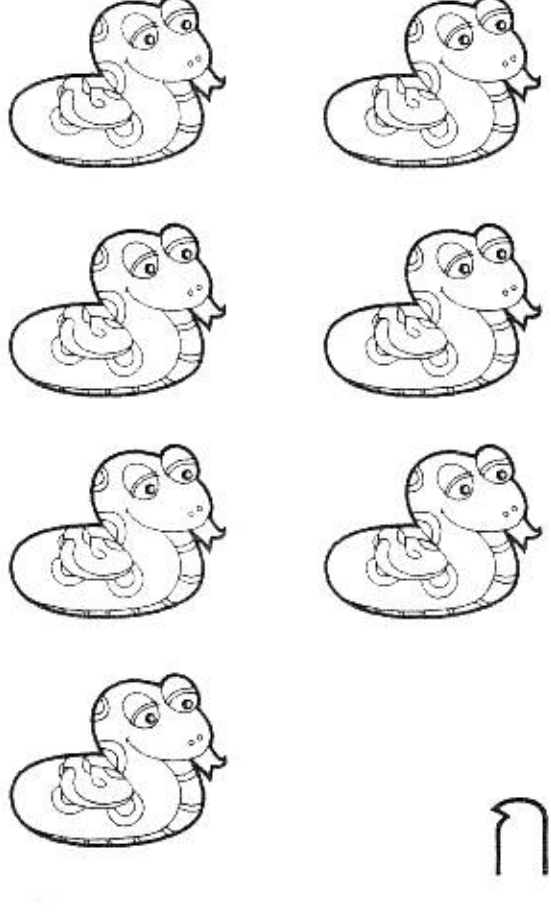
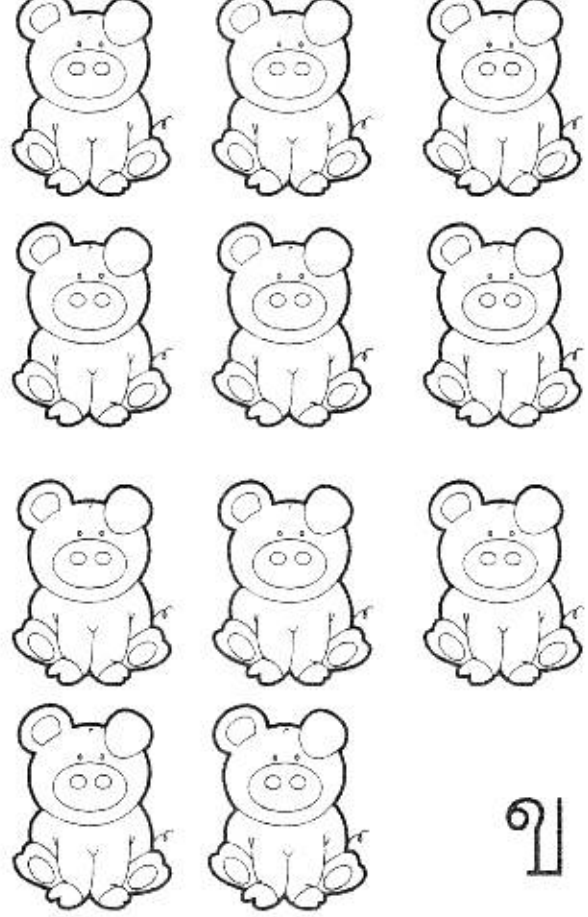
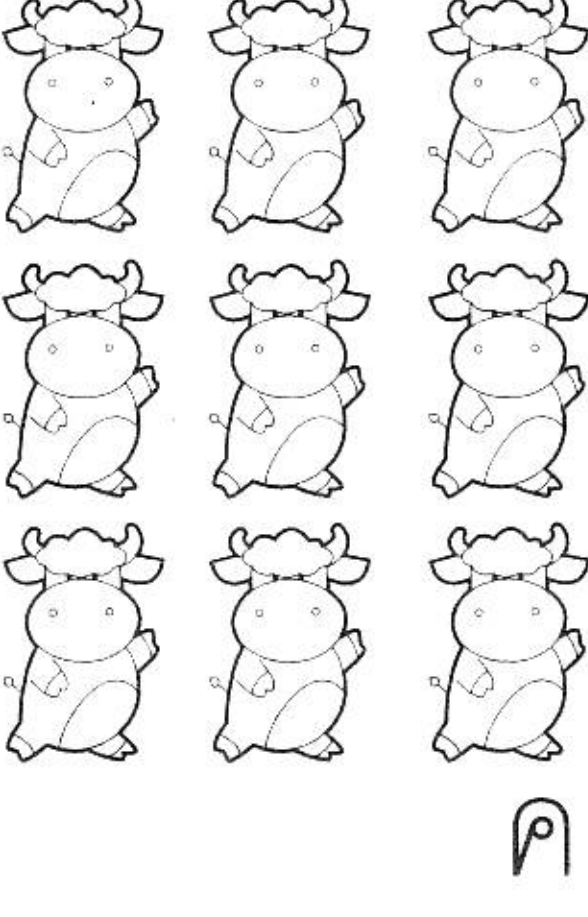
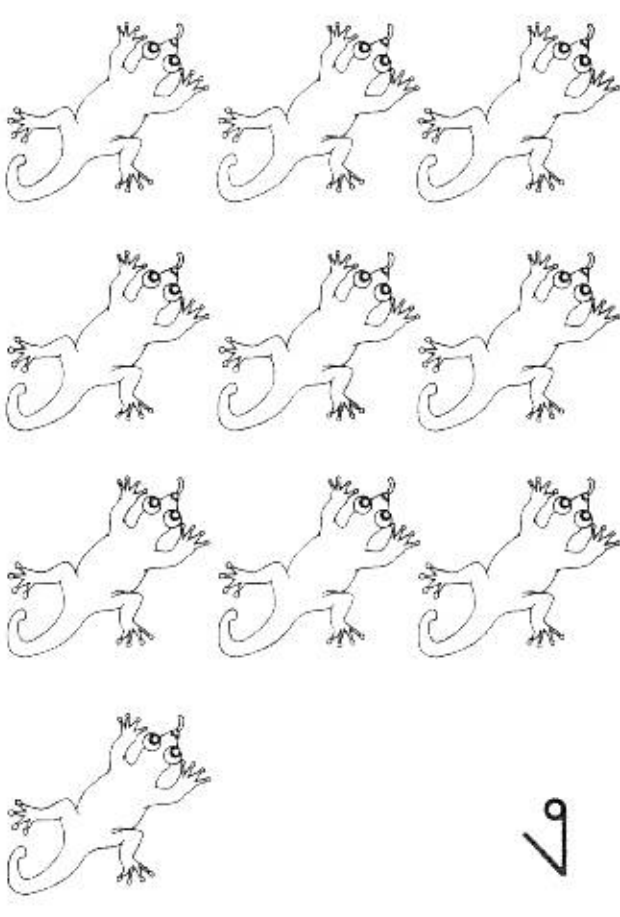
				
	ก	ข	ค	ง

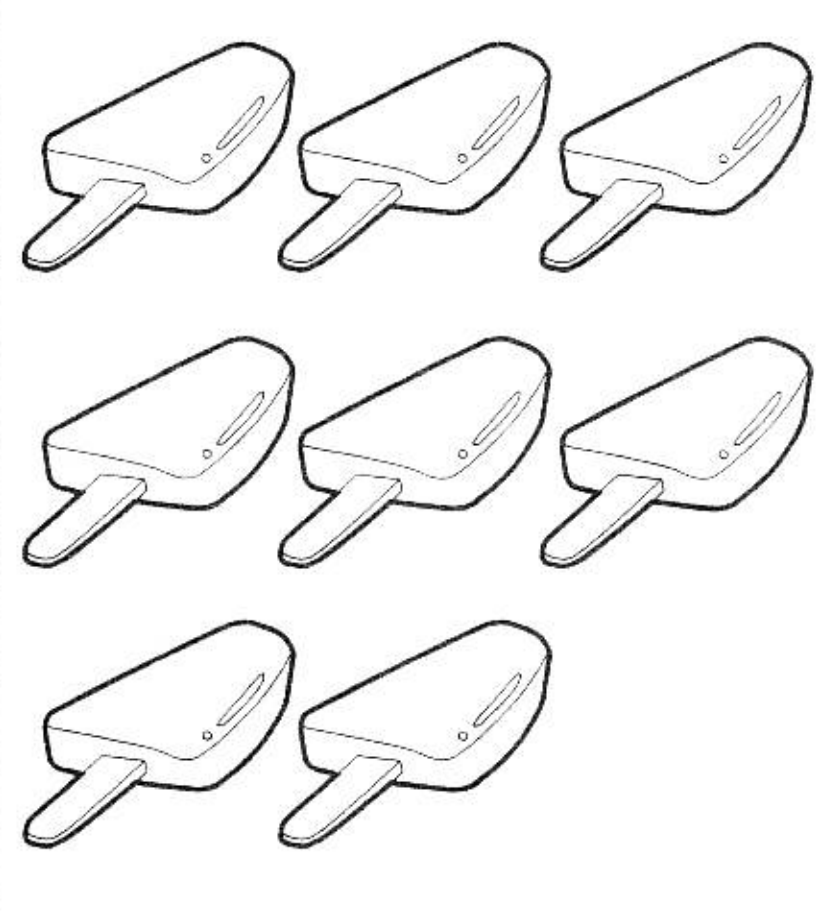
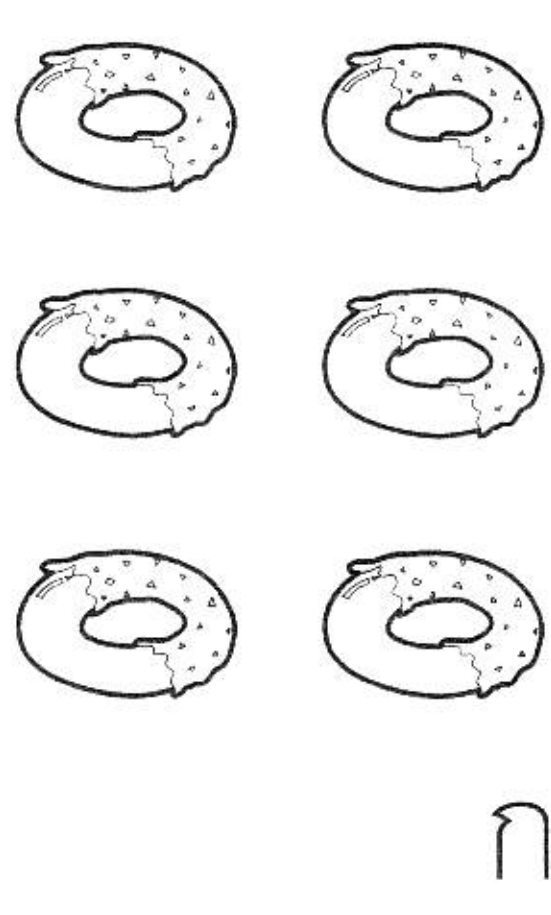
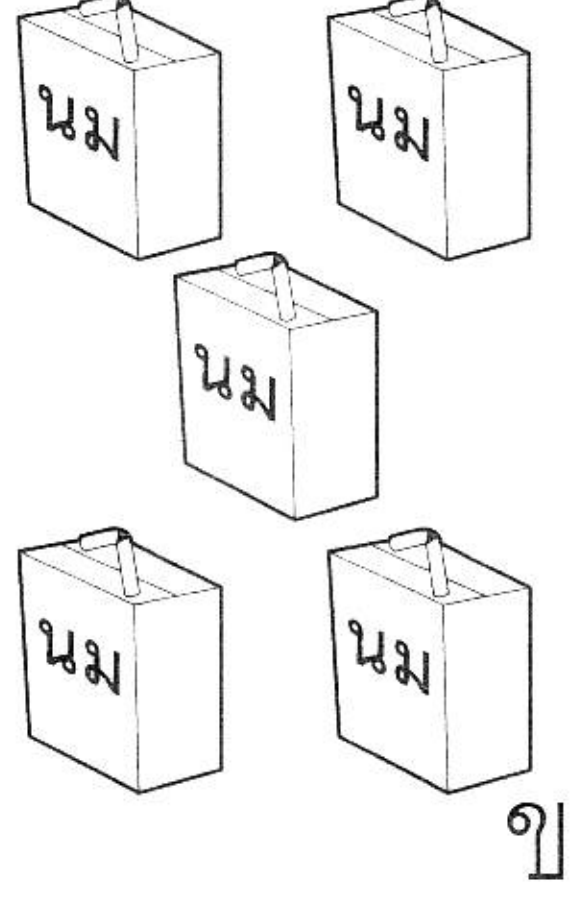
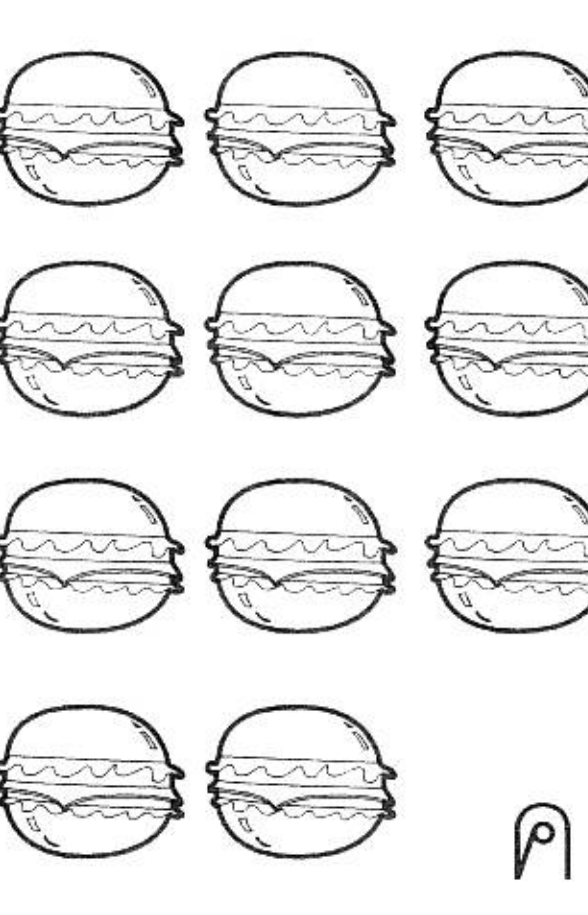
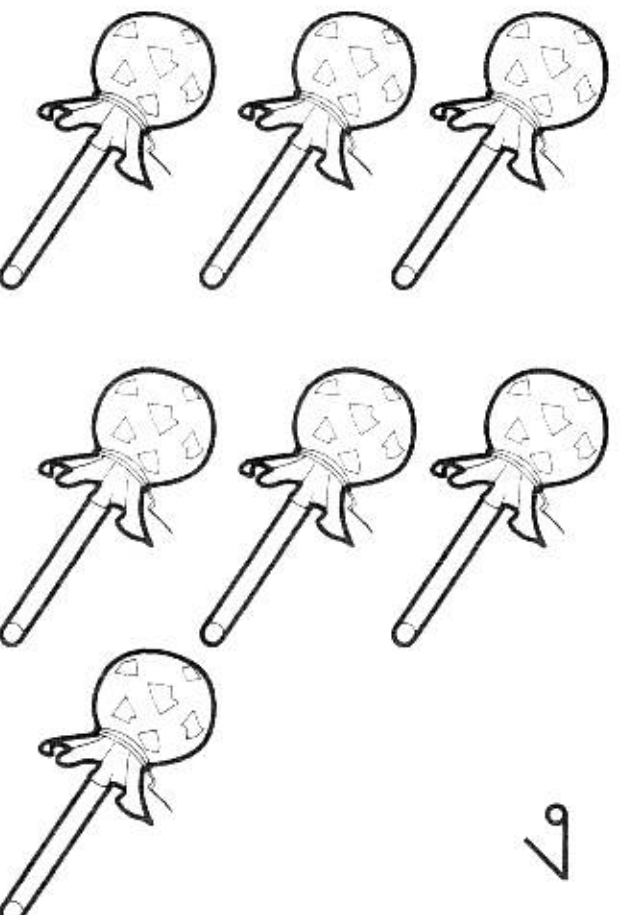

7

				
	ก	ข	ค	ง

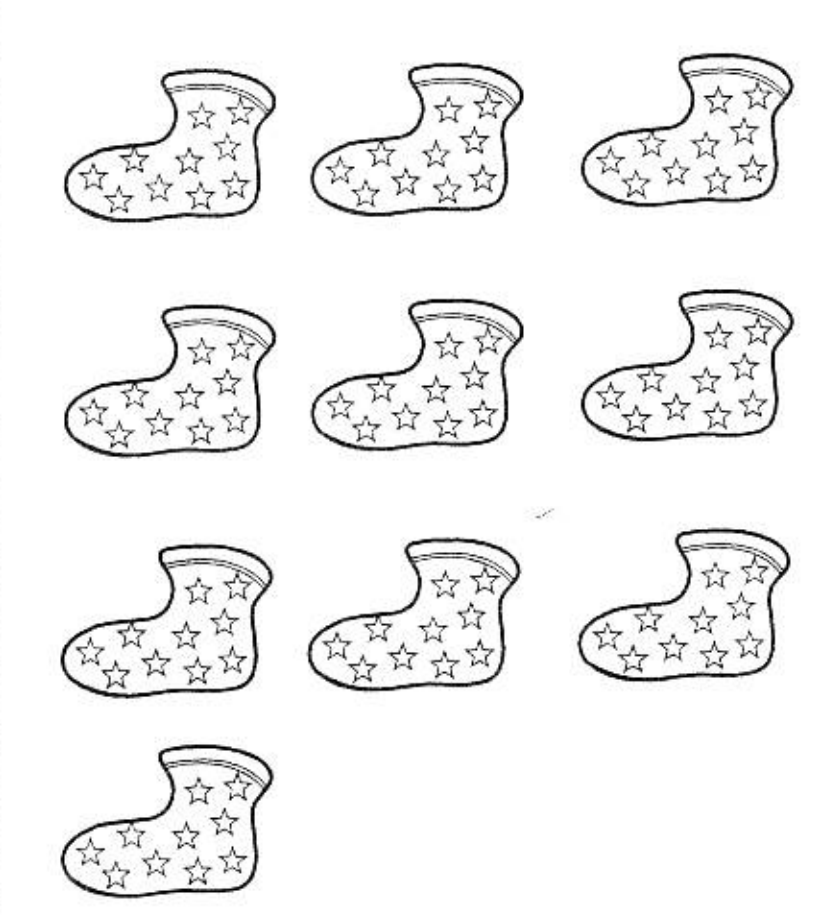
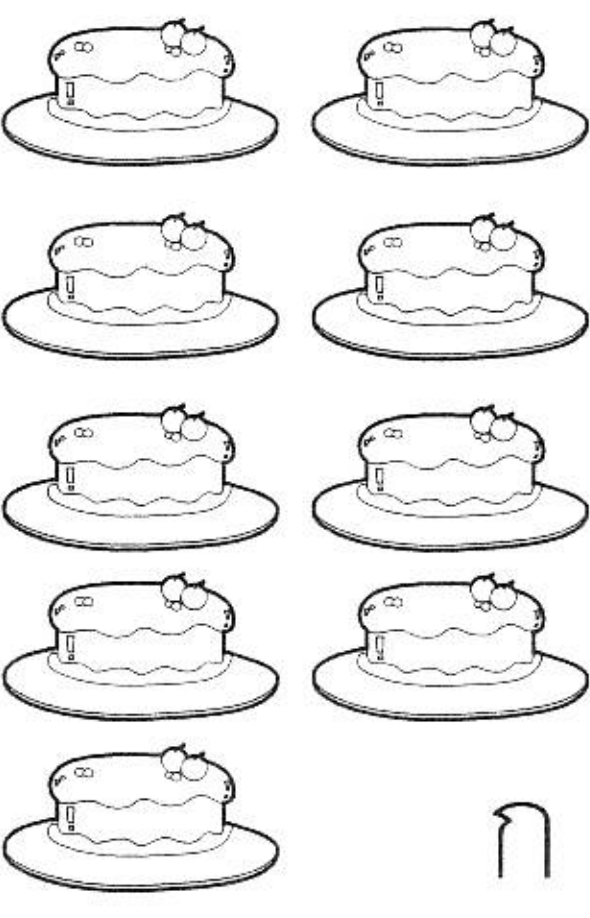
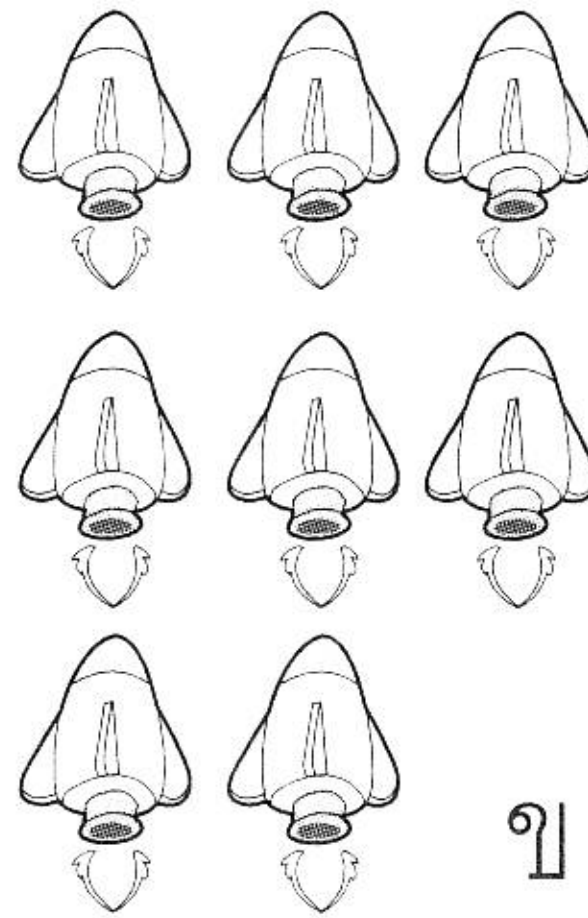
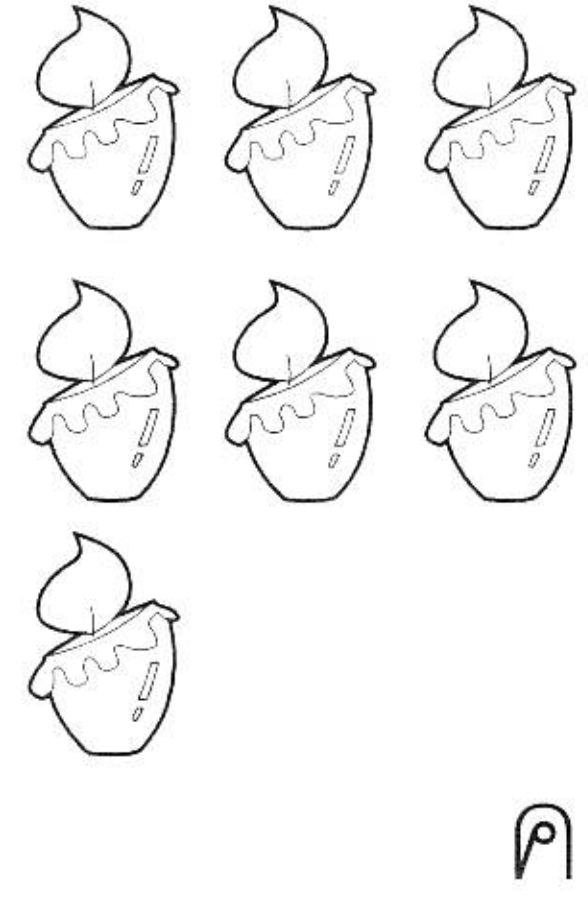
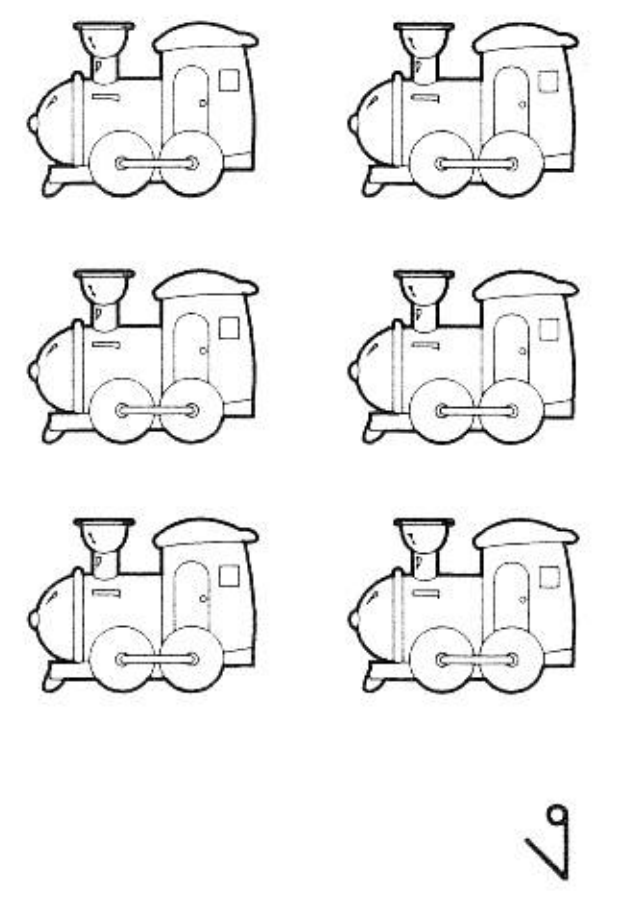
8

				
	ก	ข	ค	ง

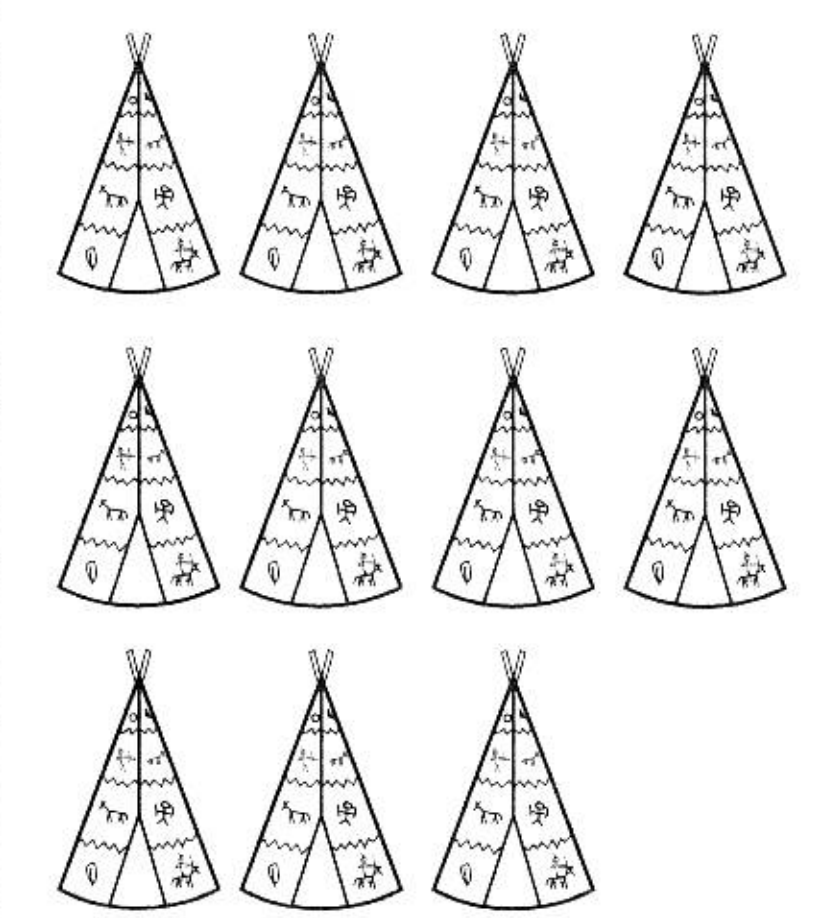
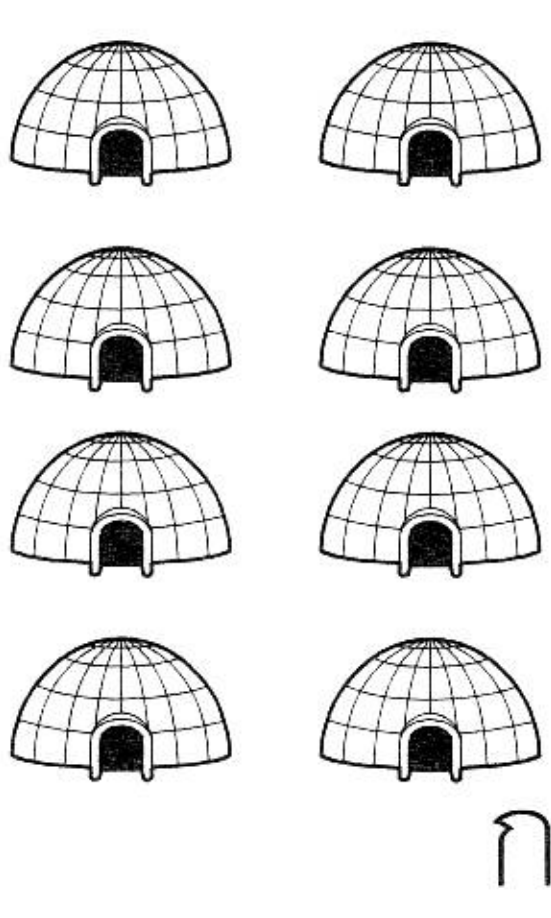
9

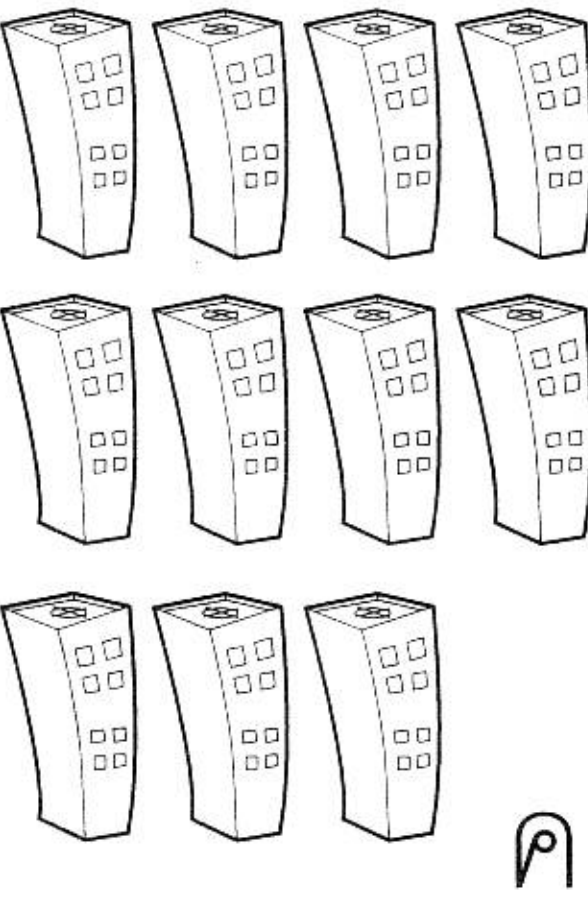
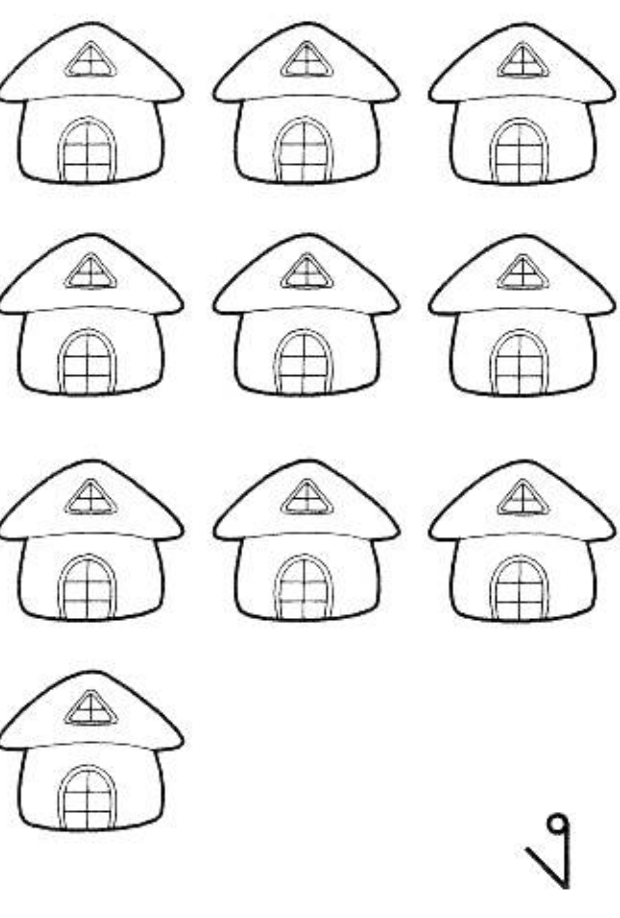
				
	ก	ข	ค	ง

10

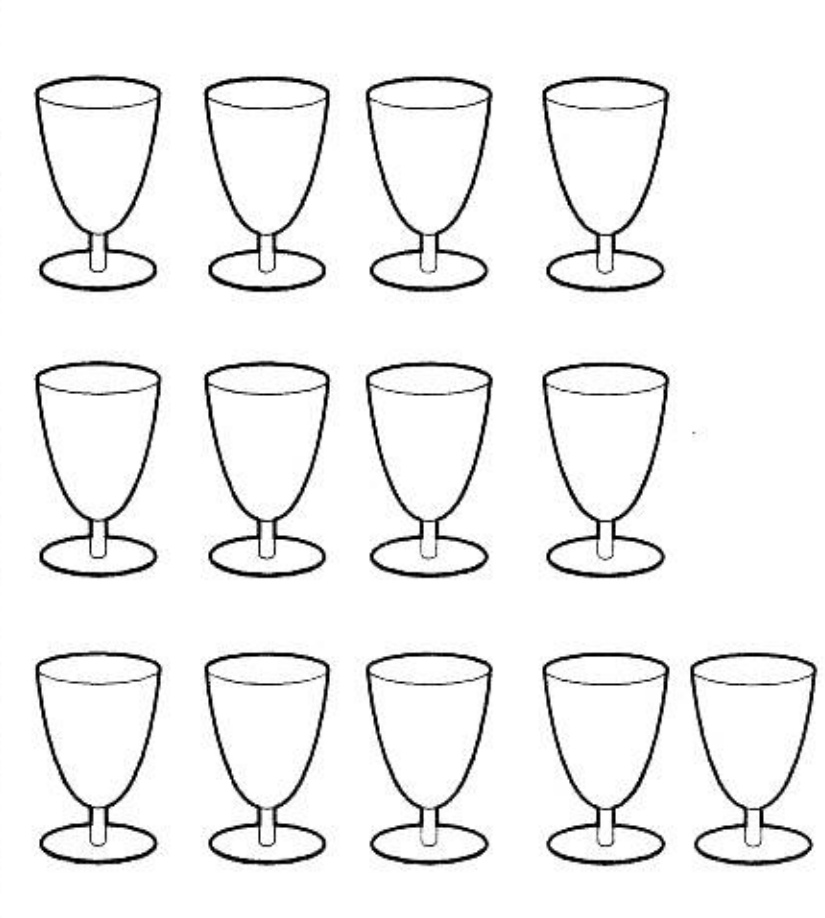
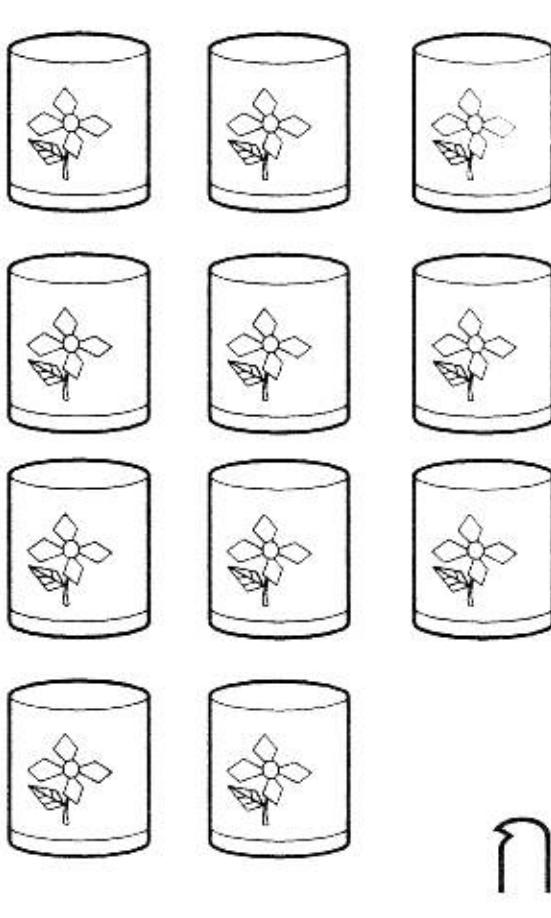
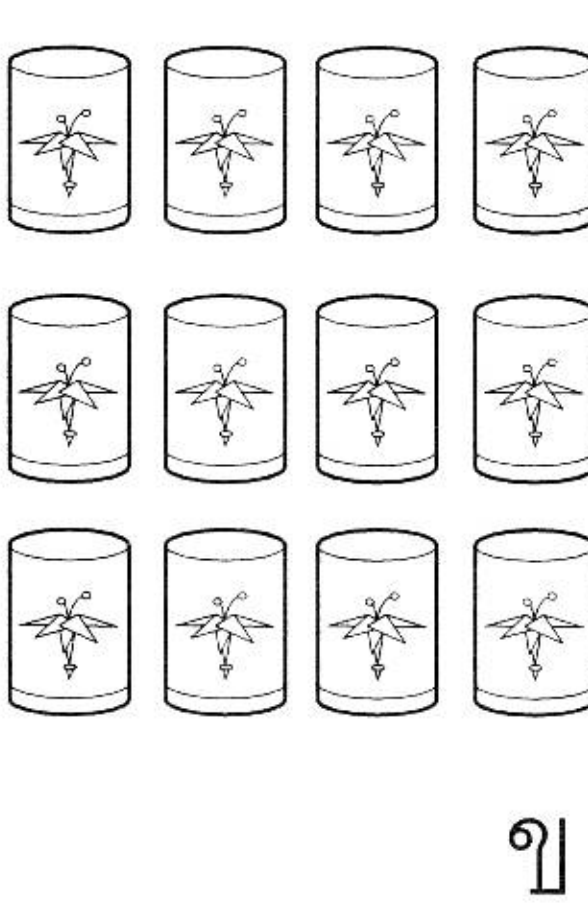
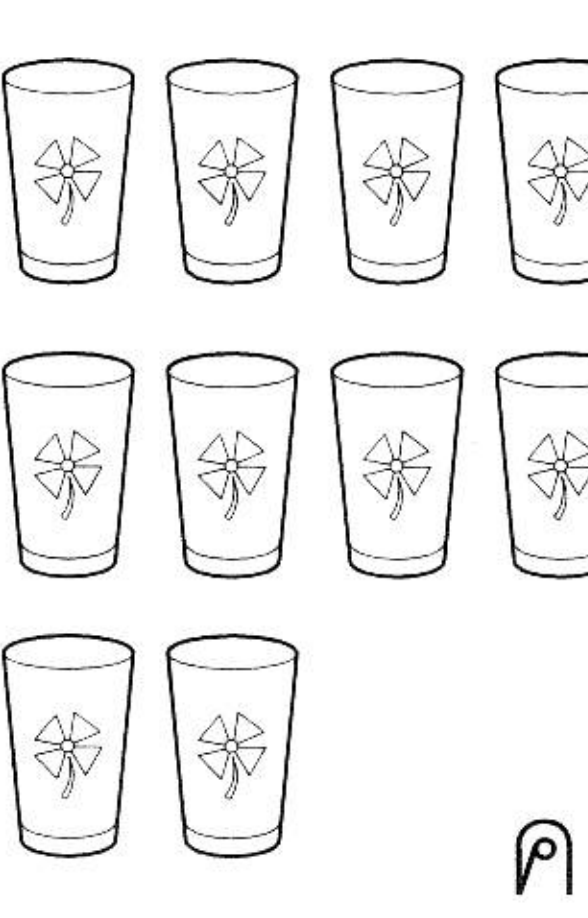
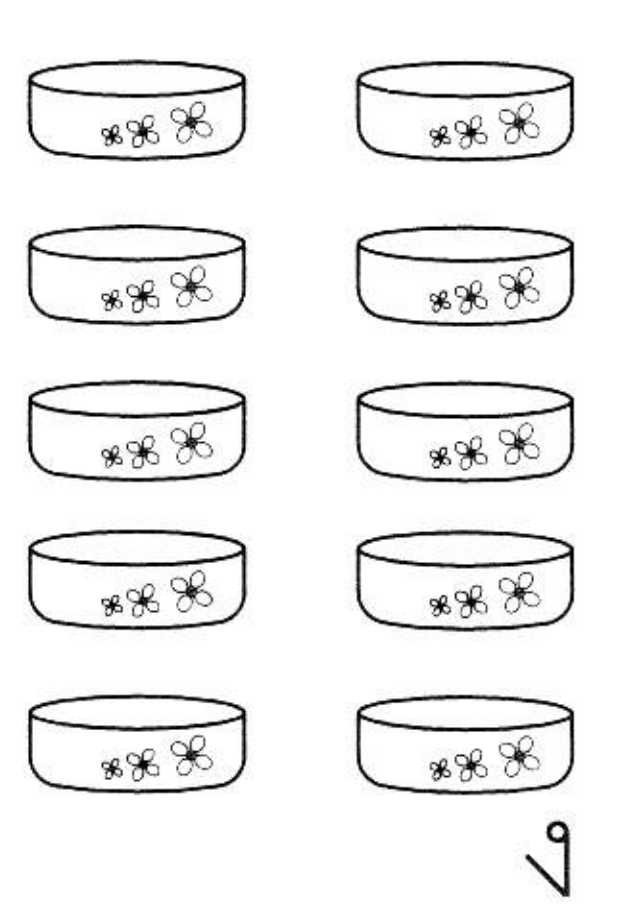
				
	ก	ข	ค	ง

อ่านคำถามแต่ละข้อให้นักเรียนฟังแล้วให้ ✓ ทับข้อที่ถูกต้อง

**1** มีปลาอยู่ในอ่าง 3 ตัว  
ออกลูกมาอีก 4 ตัว  
มีปลาอยู่ในอ่างกี่ตัว

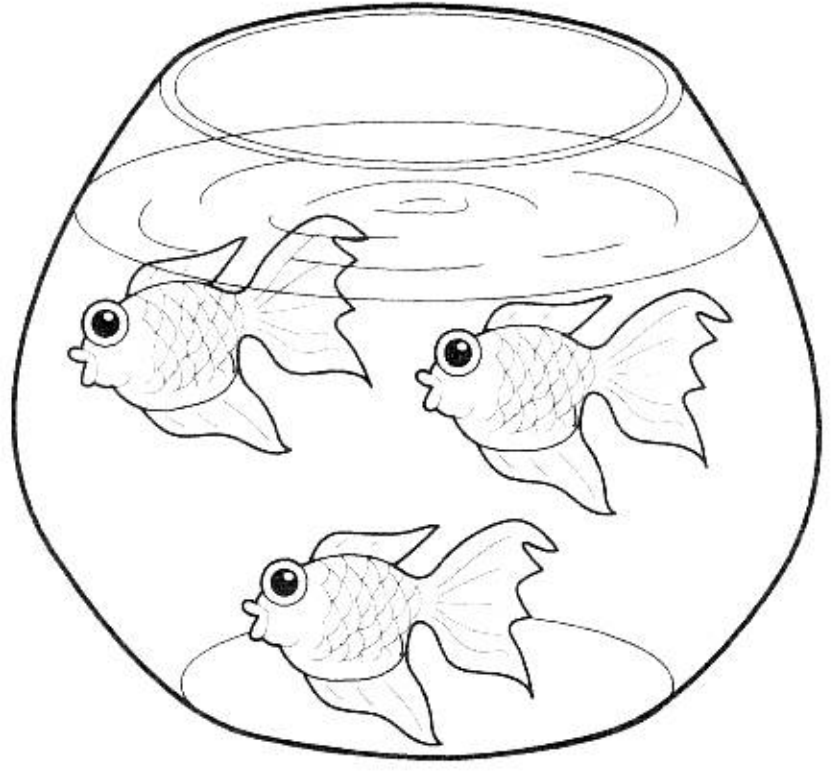

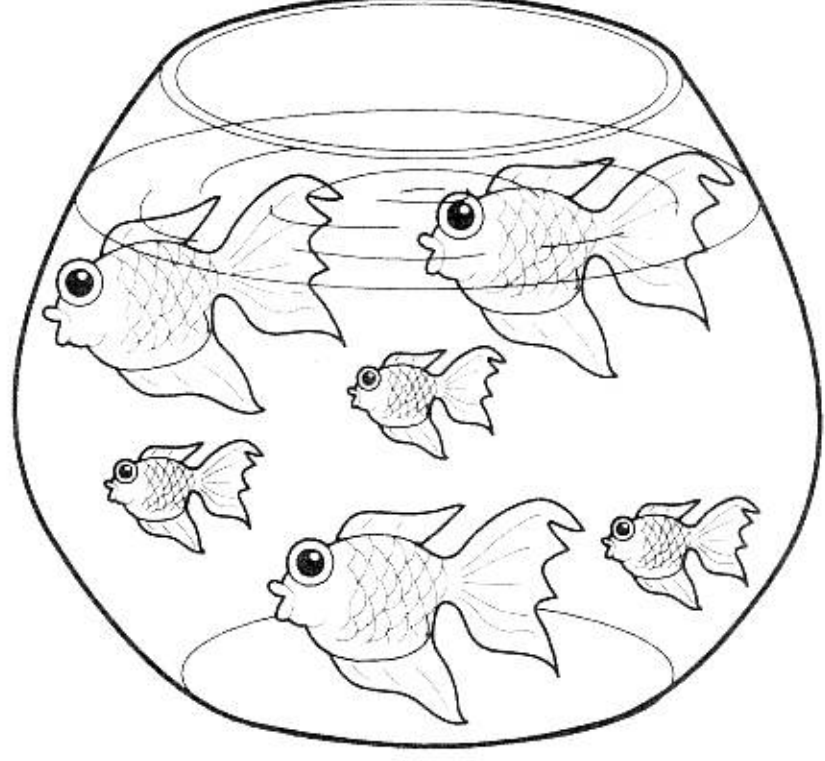
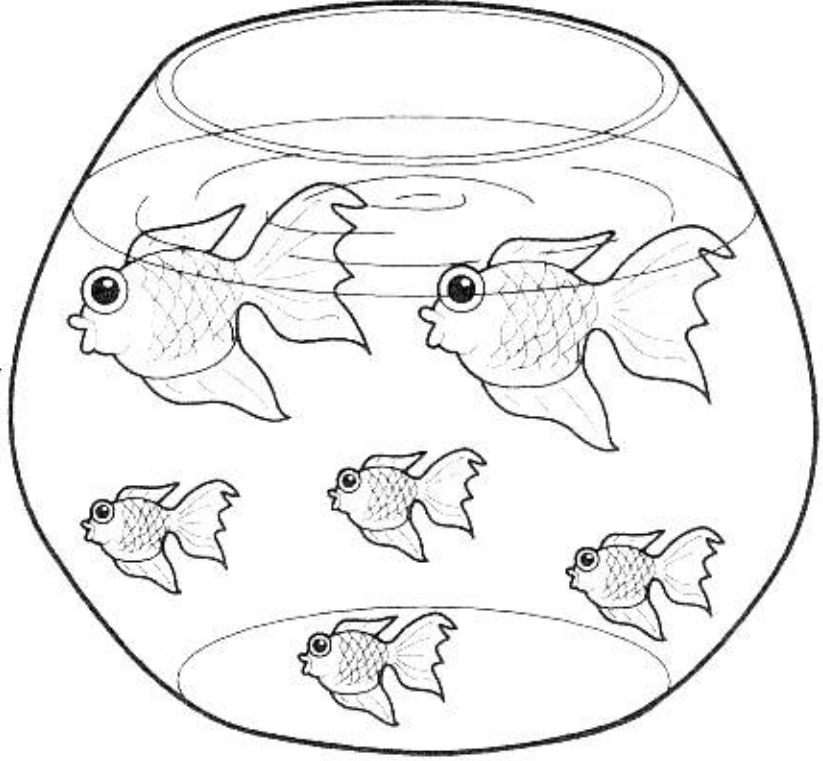
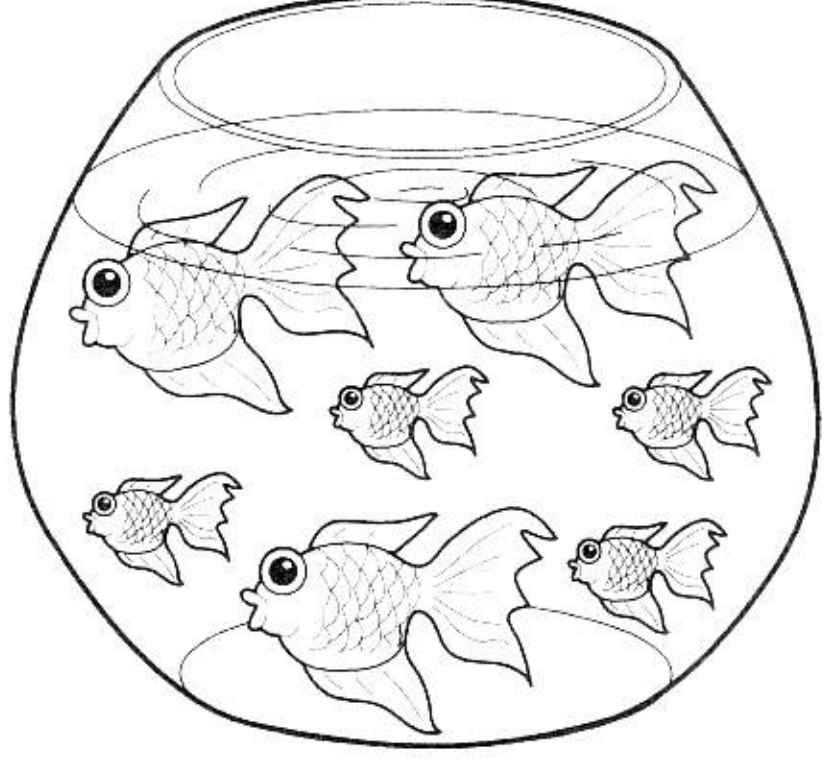
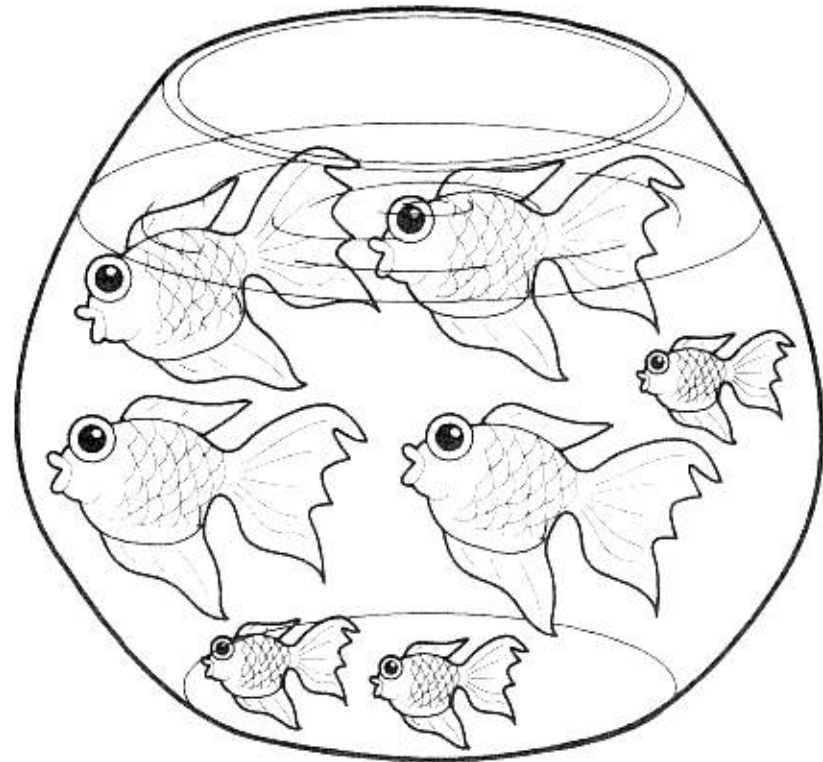
 ก	 ข
 ค	 ง

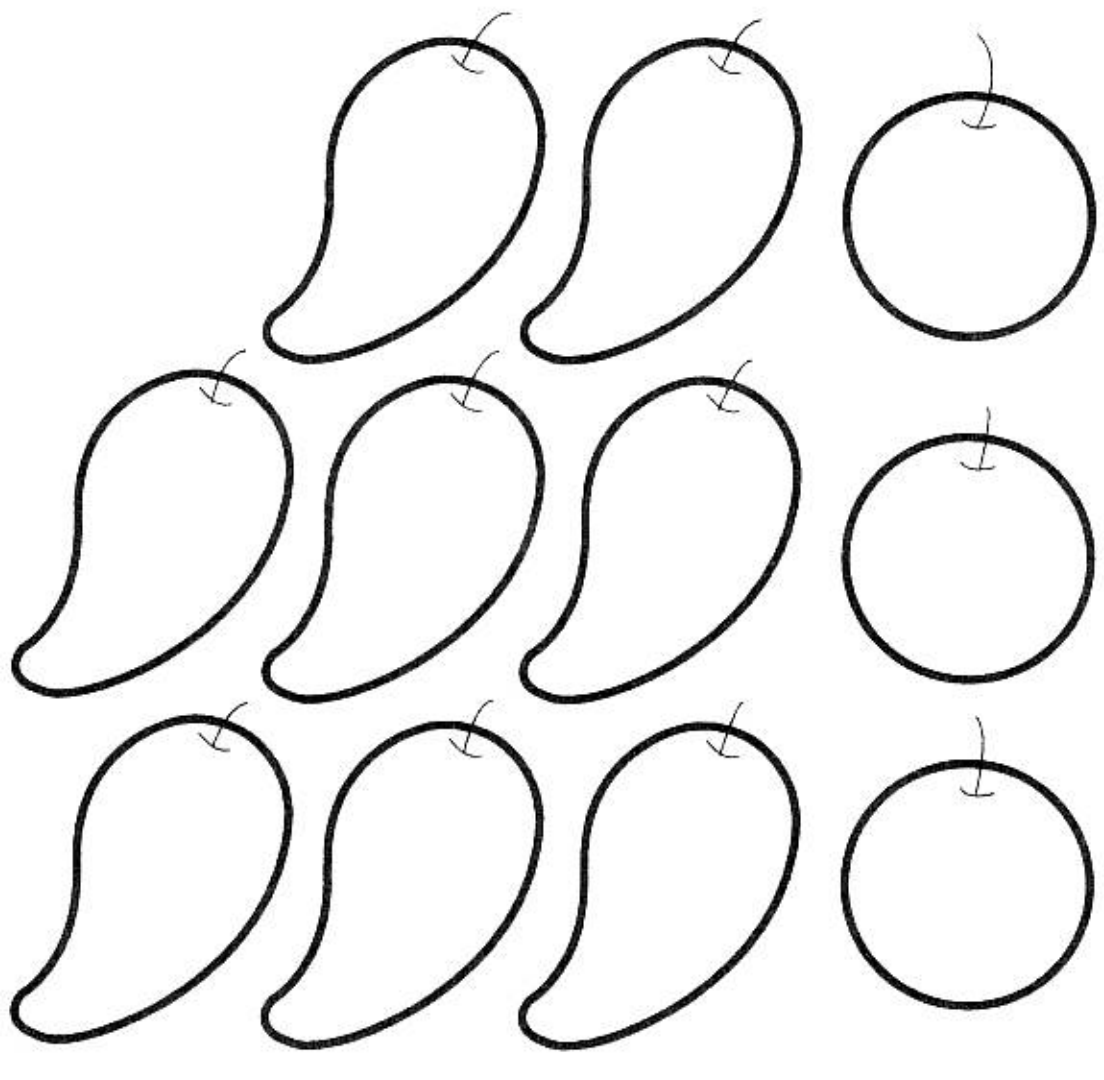

**2** มีมะม่วงอยู่ 8 ผล  
มีส้มอยู่ 3 ผล ต้องหาส้ม  
มาเพิ่มอีกกี่ผลจึง  
จะเท่ากับมะม่วง

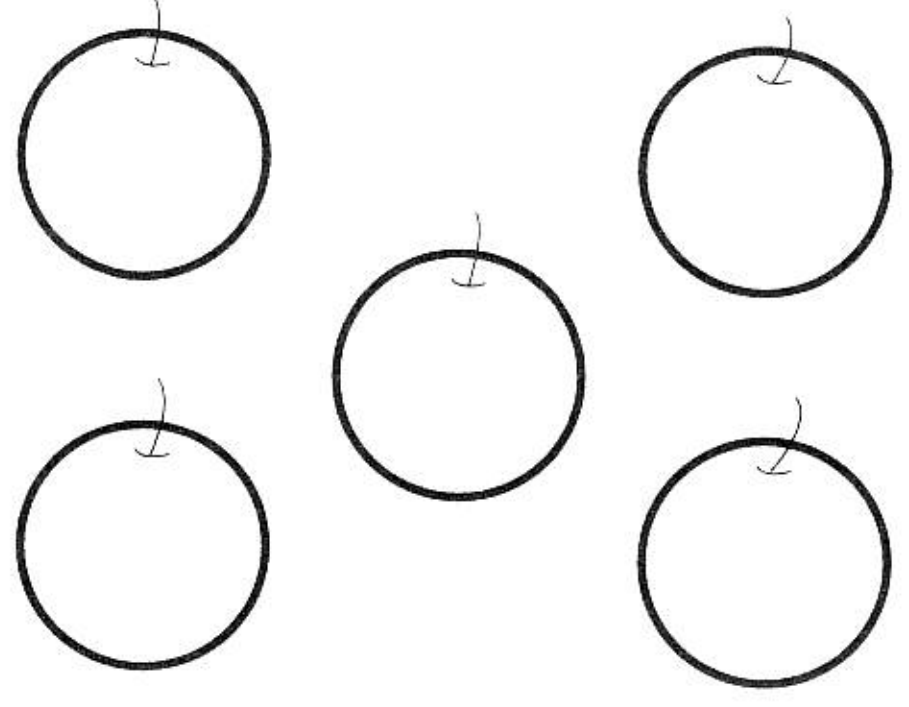
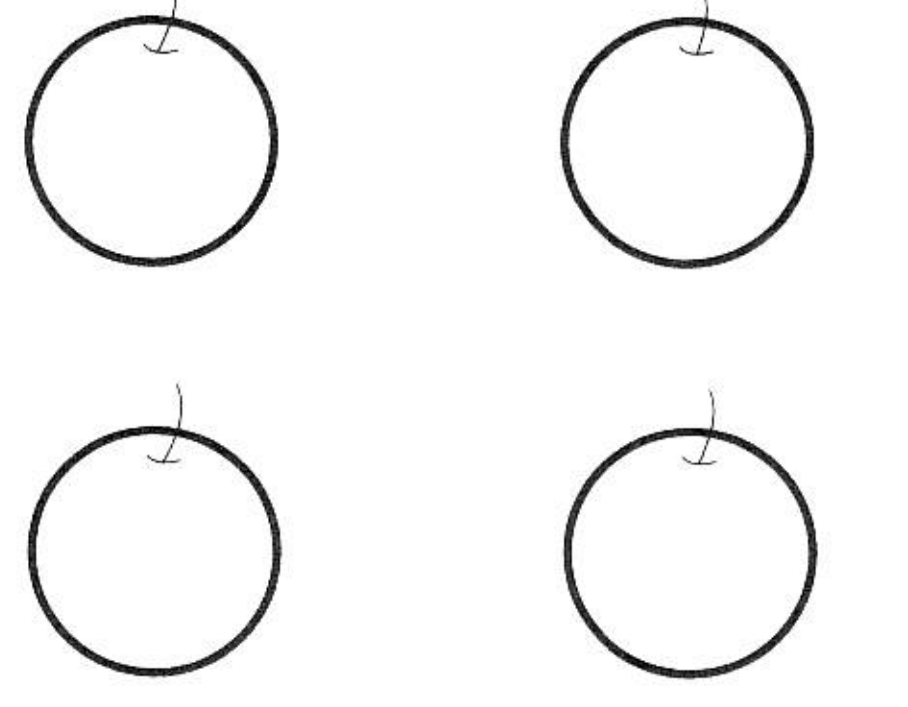
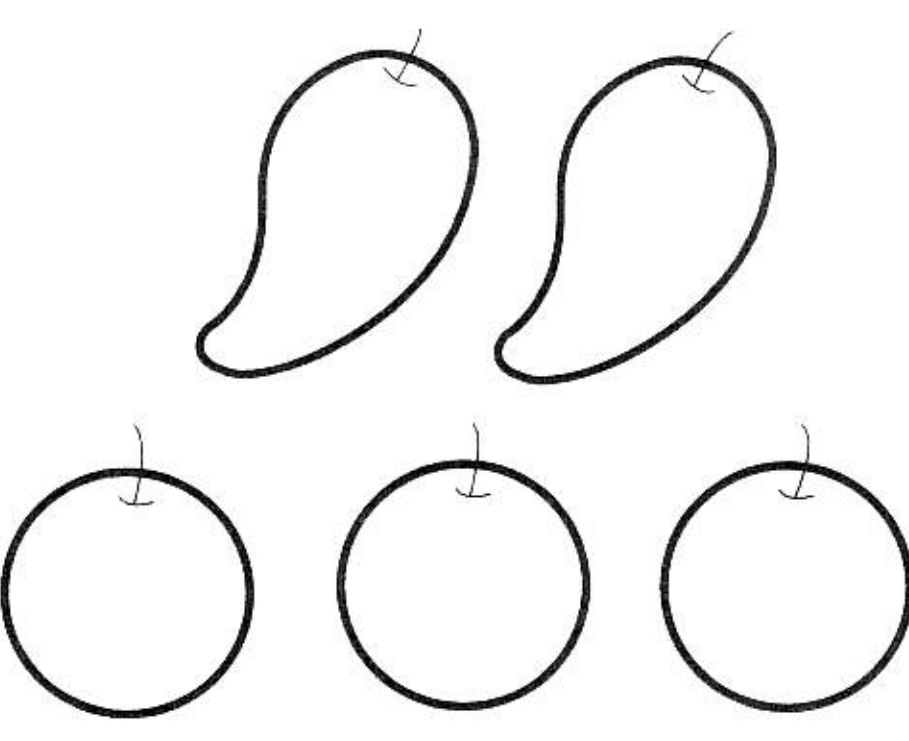
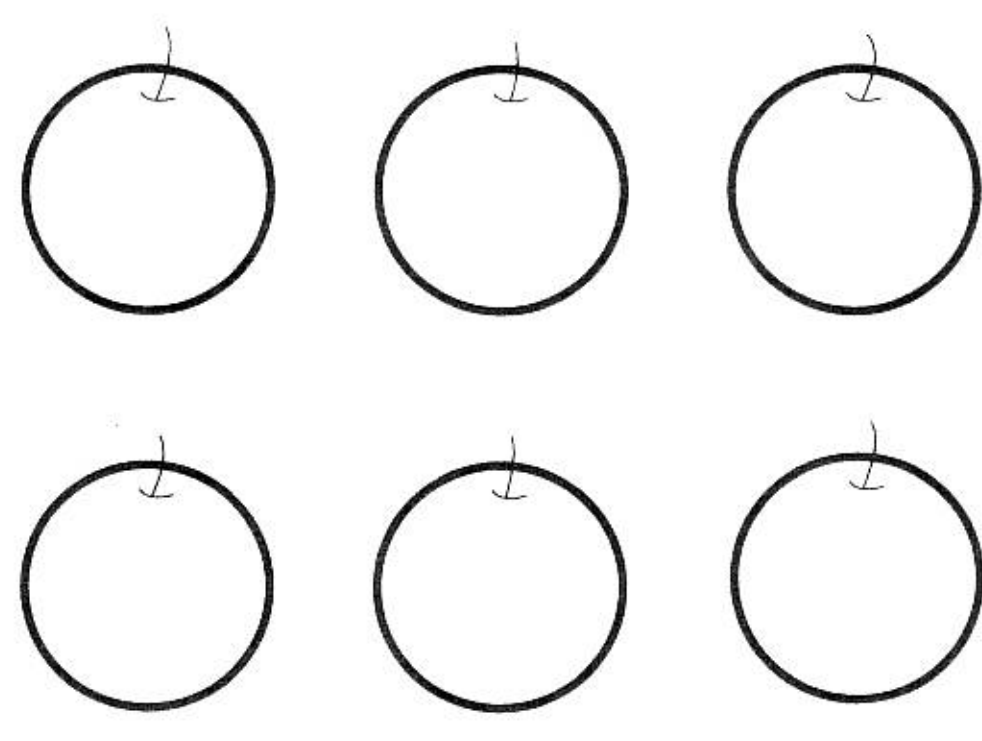

 ก	 ข
 ค	 ง

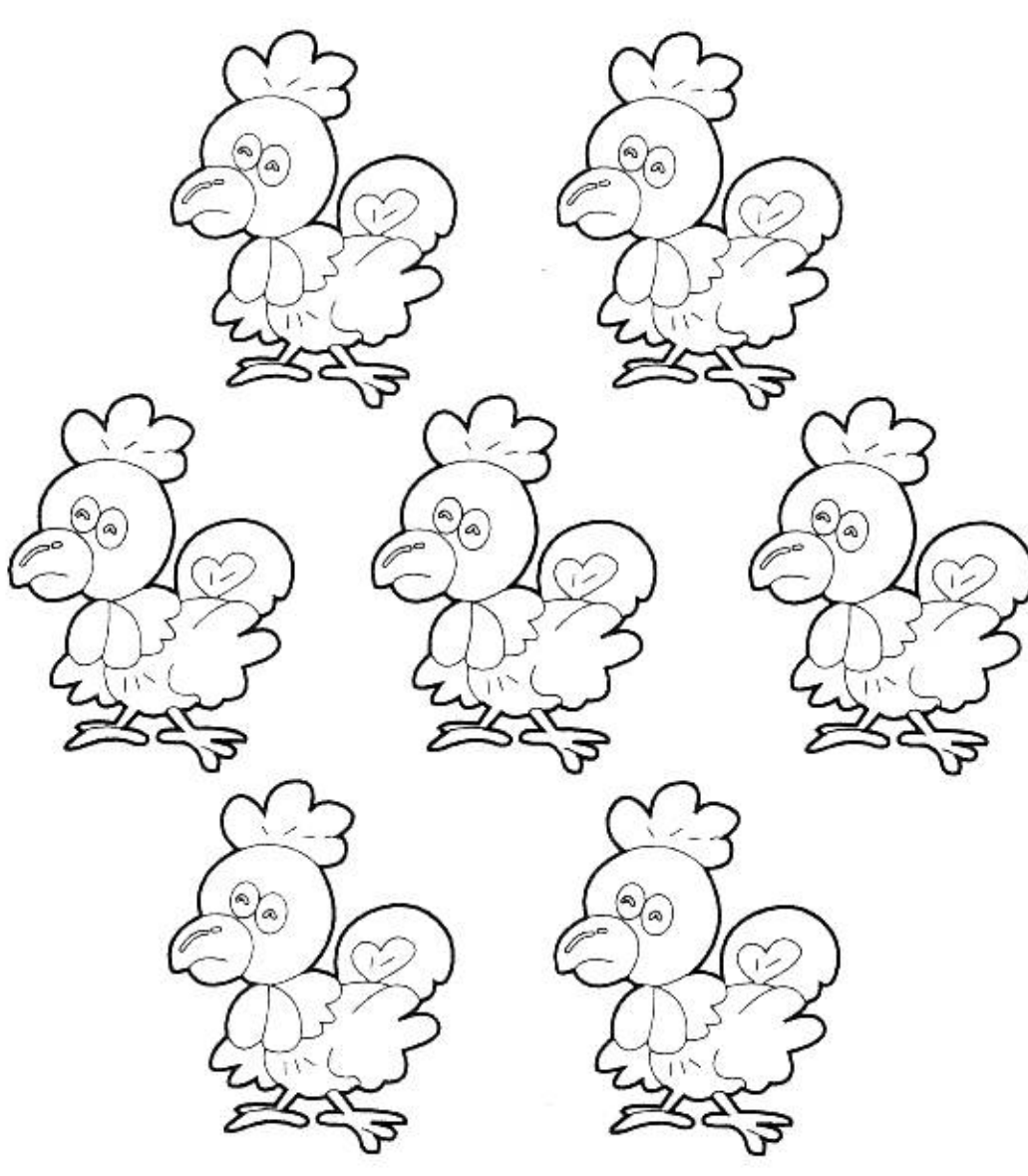
**3** ลุงเลี้ยงไก่ 7 ตัว  
ขายไป 5 ตัว ลุงมีไก่กี่ตัว

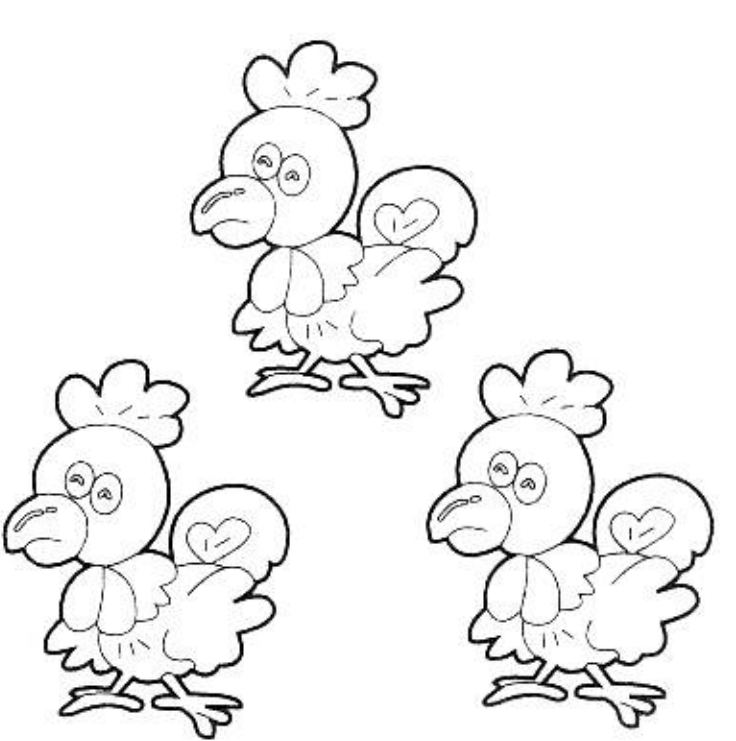
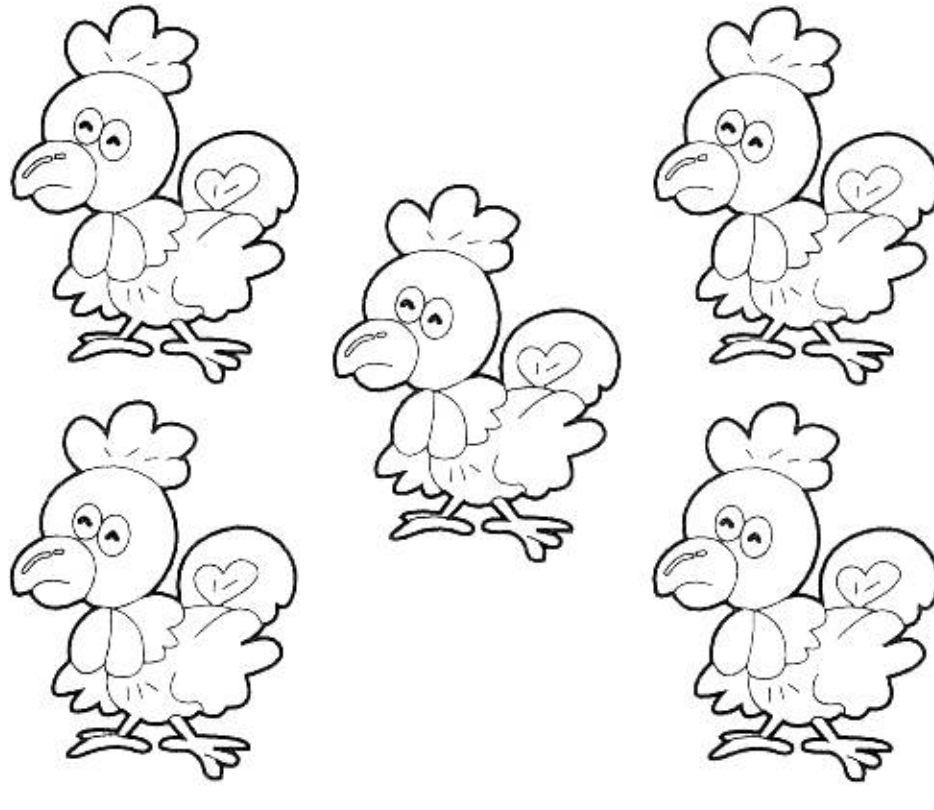
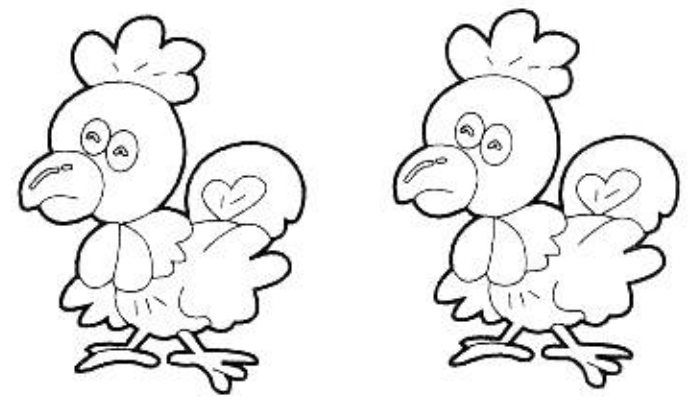

 ก	 ข
 ค	 ง

4 น้องมีขนม 3 ชิ้น  
แม่ให้มาอีก 2 ชิ้น  
น้องมีขนมกี่ชิ้น

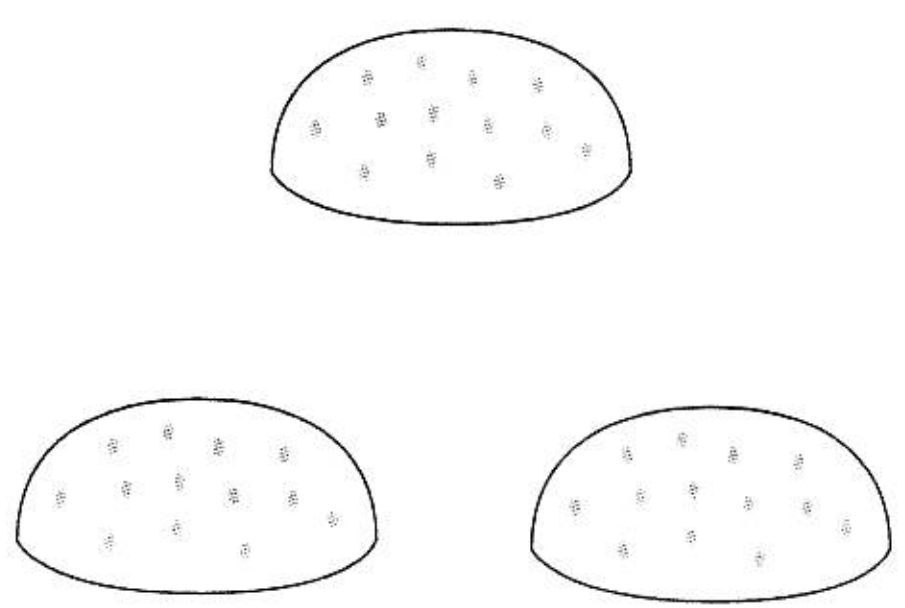
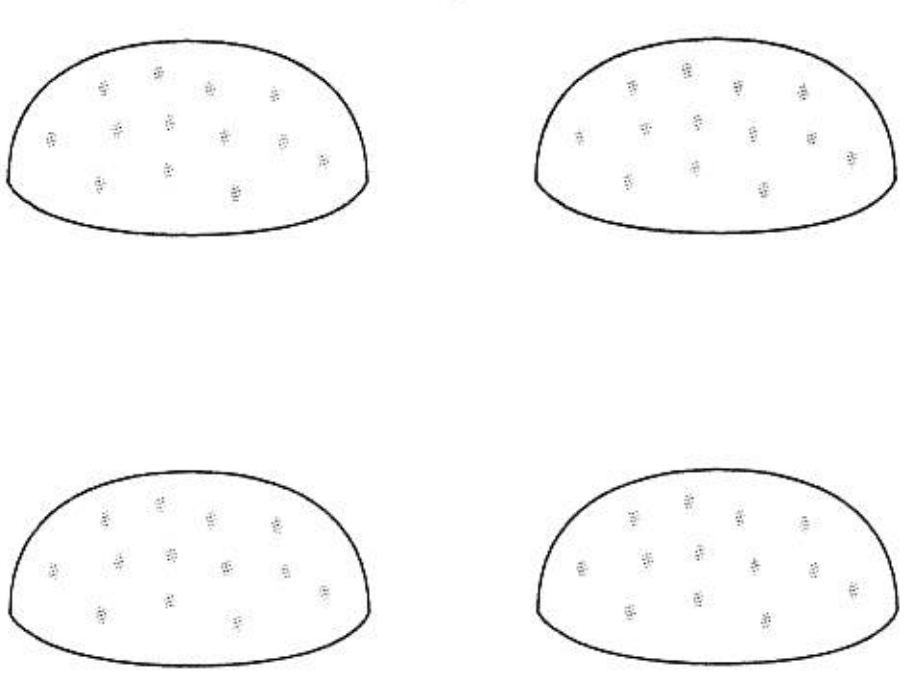
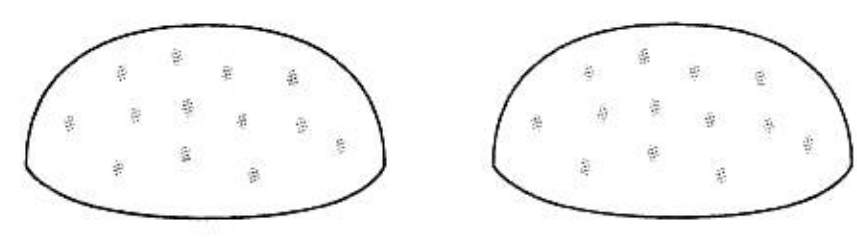
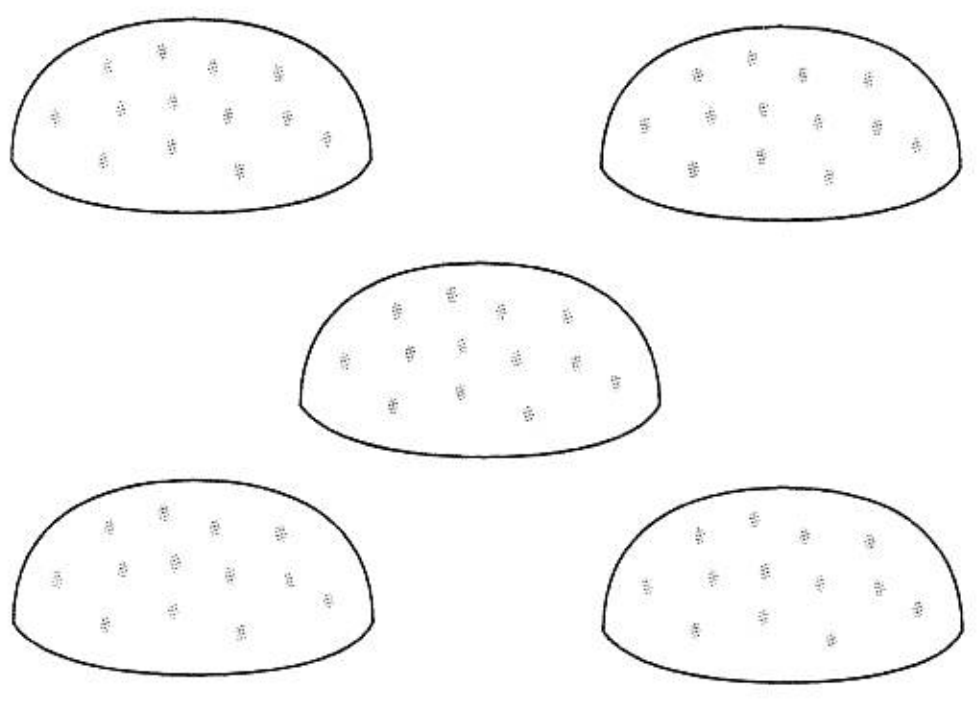

 <p>ก</p>	 <p>ข</p>
 <p>ค</p>	 <p>ง</p>

5 เป็ดออกไข่มา 8 ฟอง  
ฟักเป็นตัว 4 ฟอง  
ยังไม่ฟักอีกกี่ฟอง

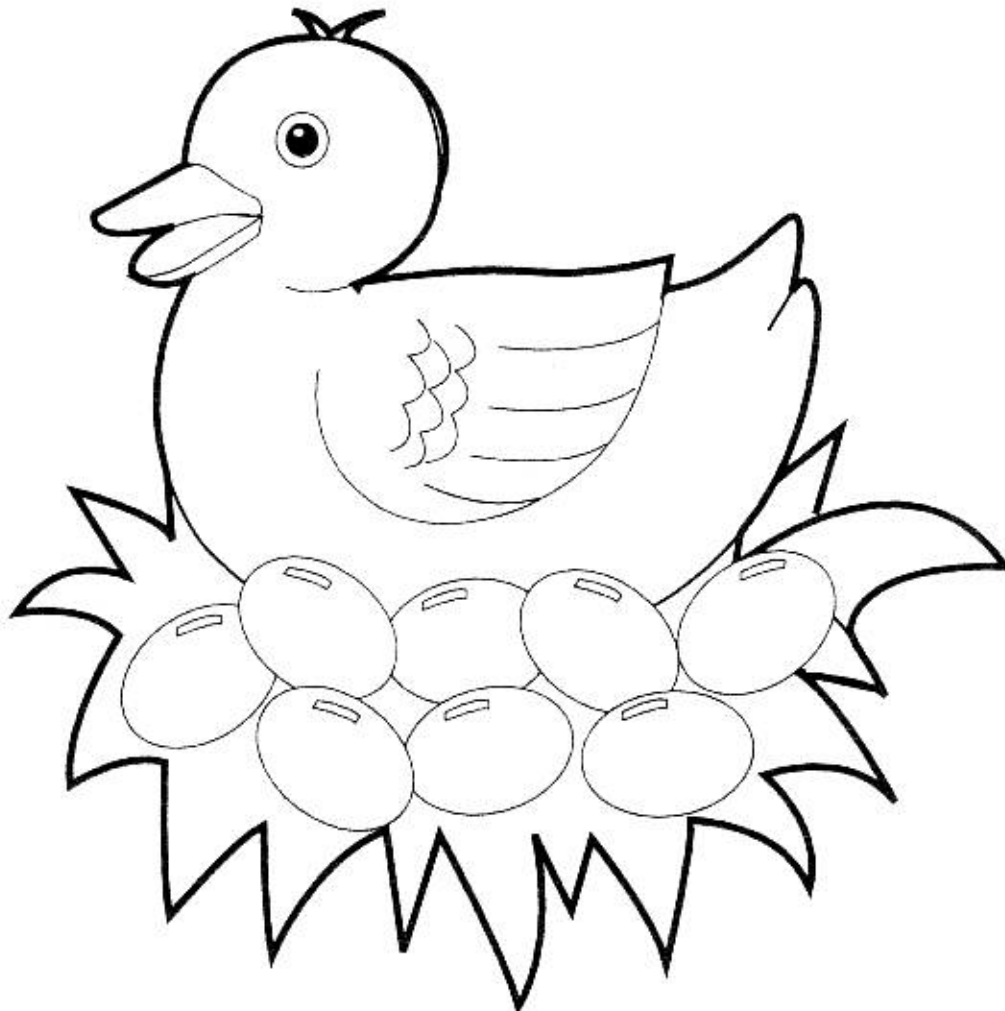

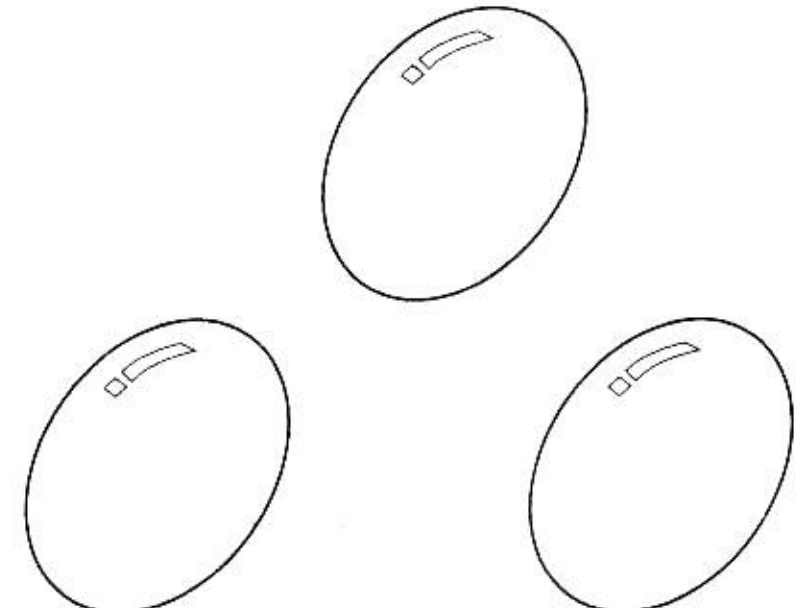
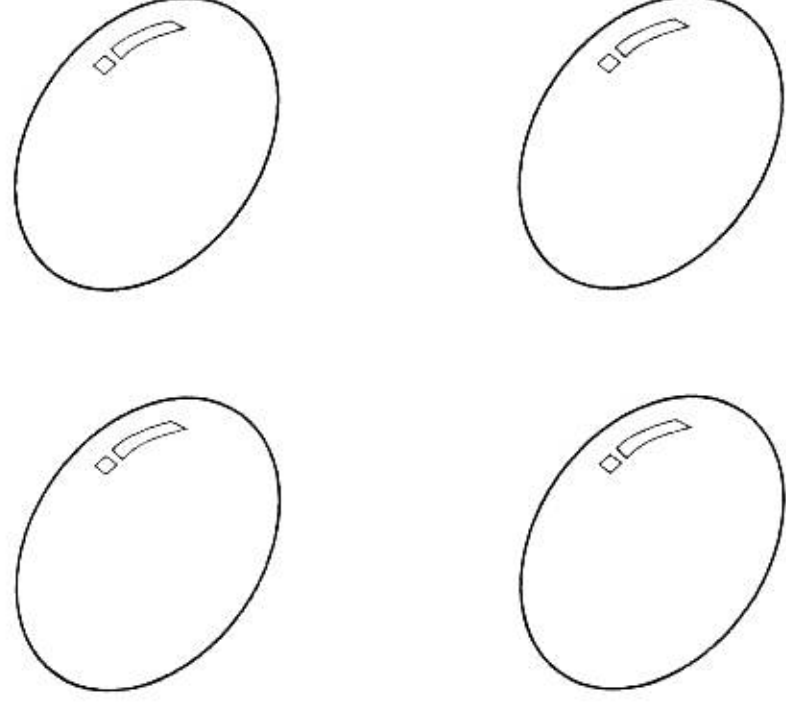
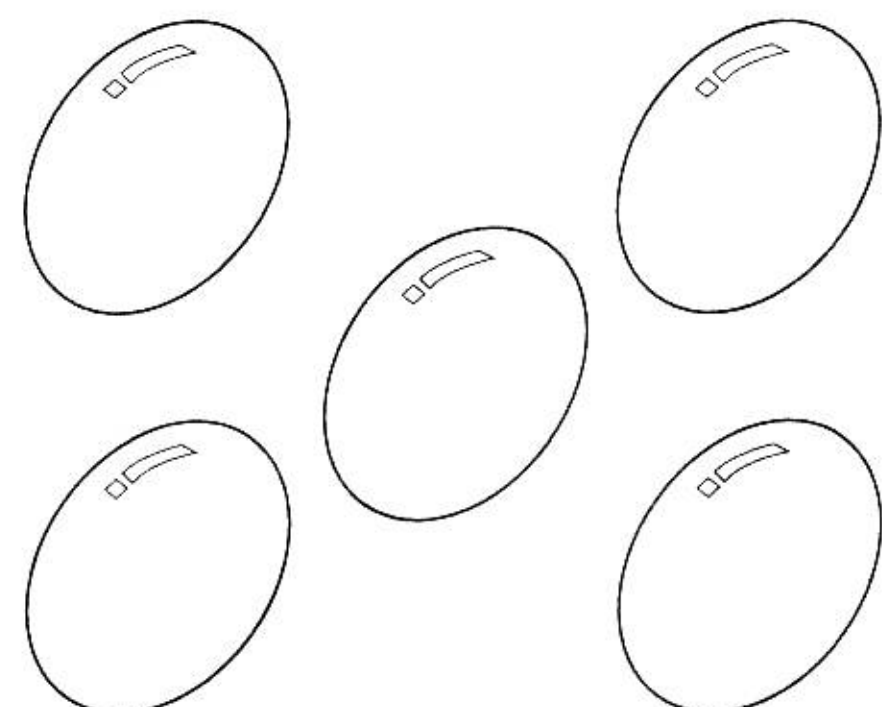
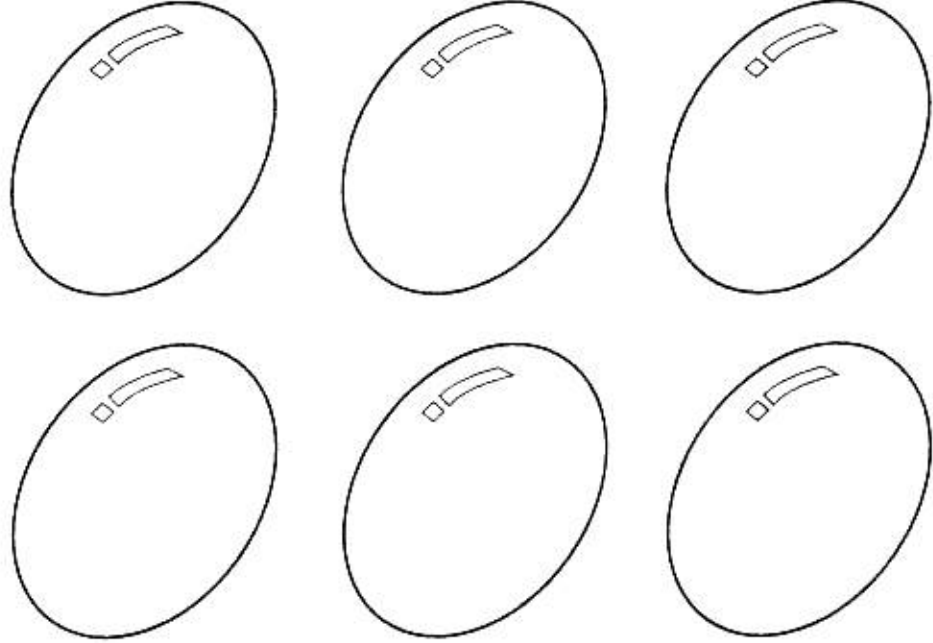
 <p>ก</p>	 <p>ข</p>
 <p>ค</p>	 <p>ง</p>

6 มีดอกไม้ 10 ดอก  
จัดใส่แจกัน 6 ดอก  
จะเหลือกี่ดอก

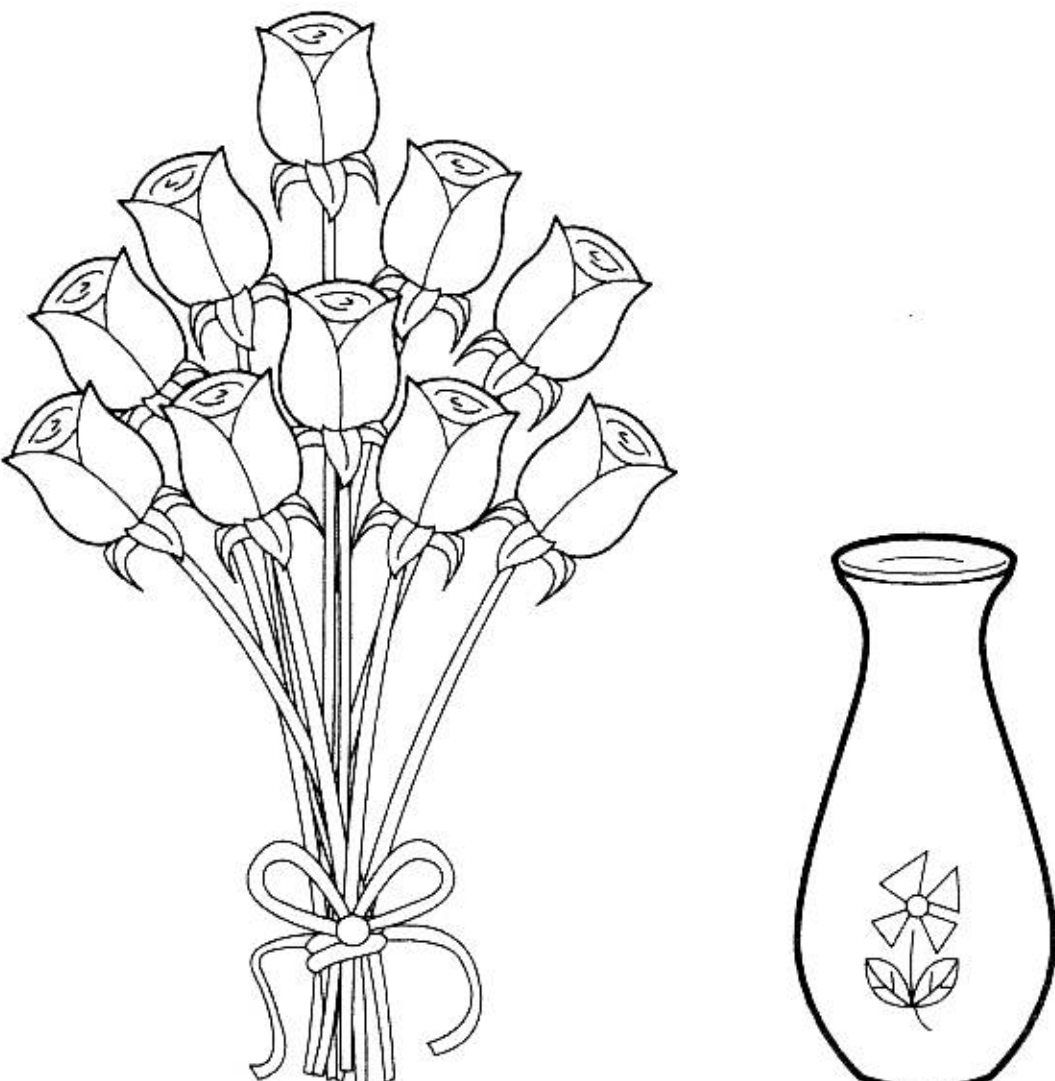

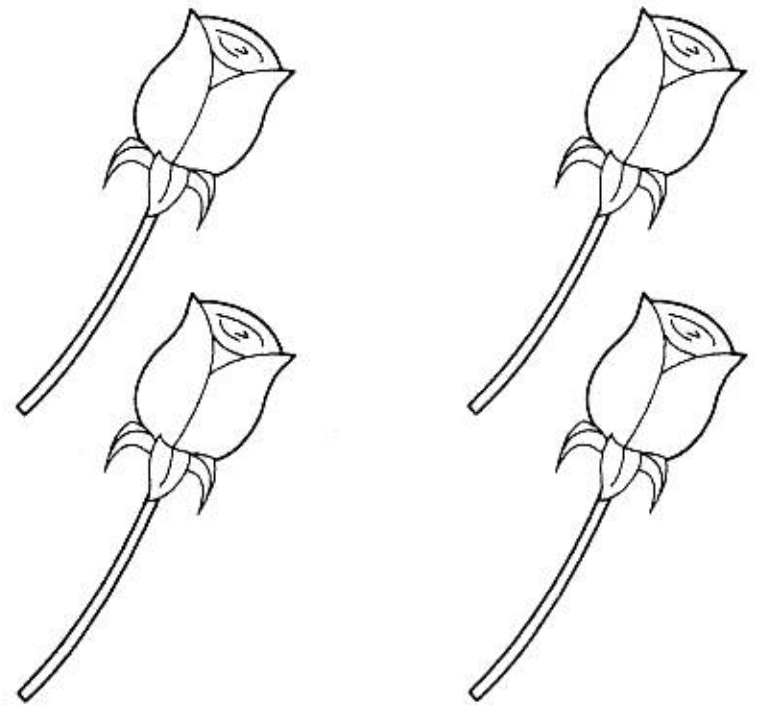
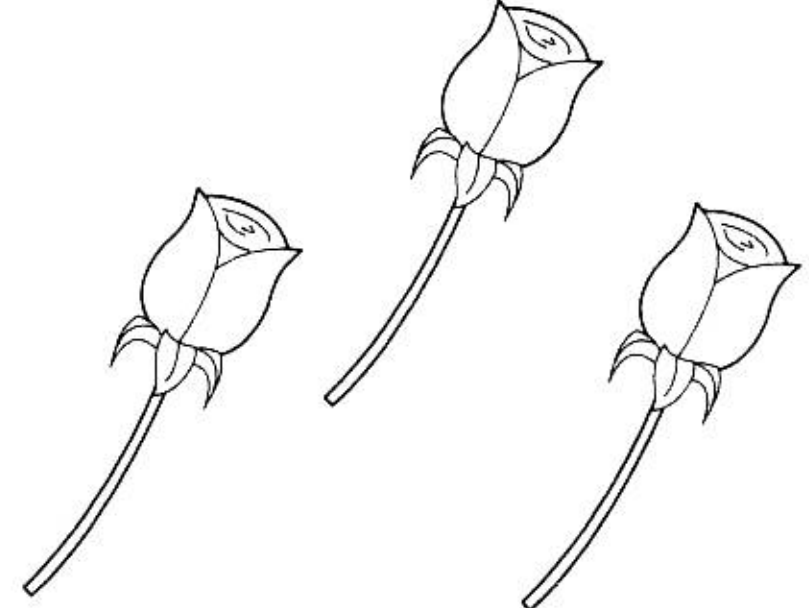
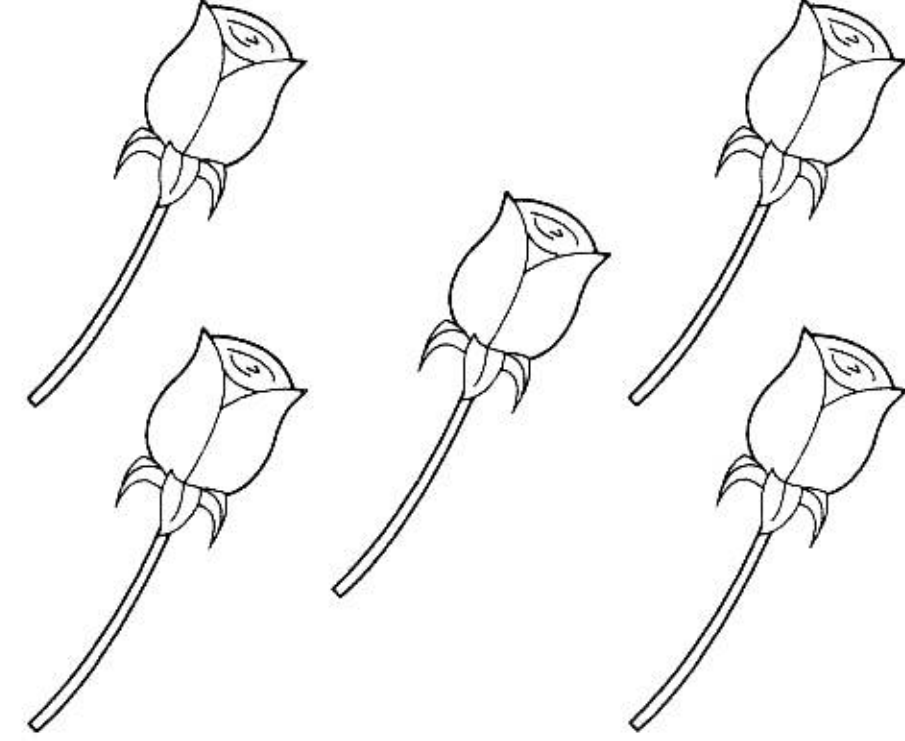
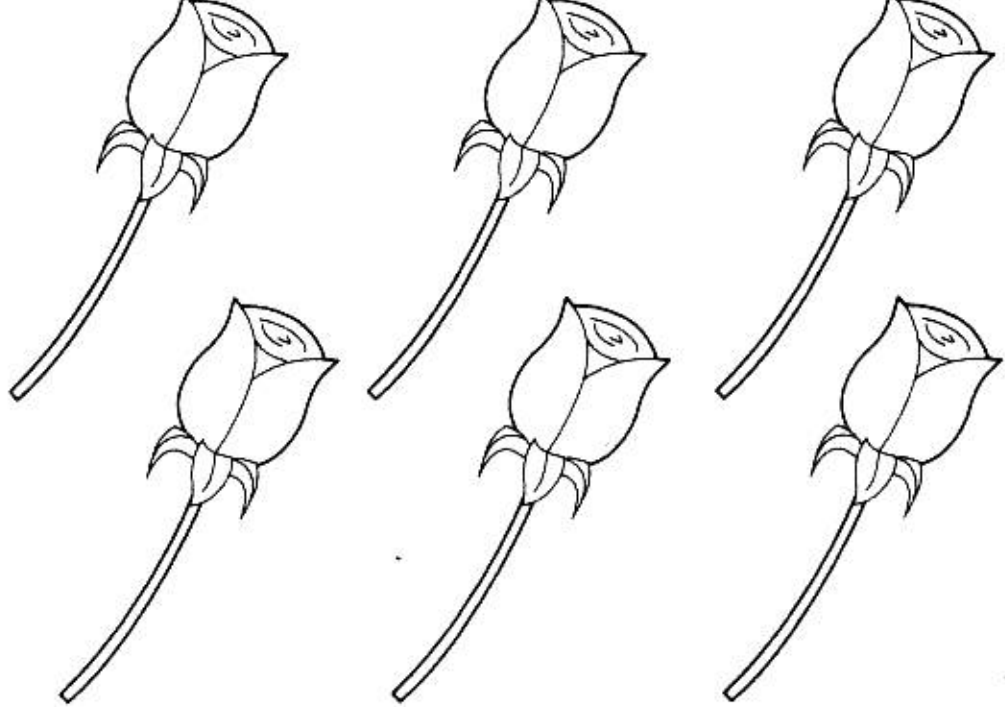
 <p>ก</p>	 <p>ข</p>
 <p>ค</p>	 <p>ง</p>

7 ฉันทึ่เลียงนก 3 ตั๋ว  
นั้บขาตั้งหมดได้กั้ขา

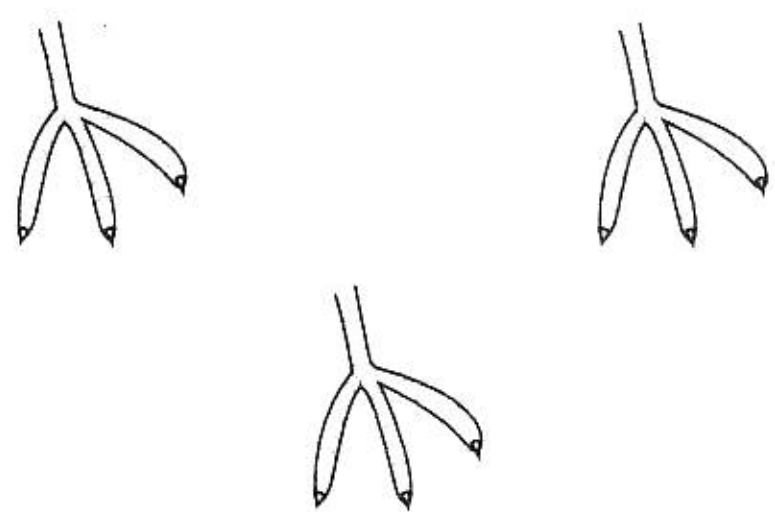
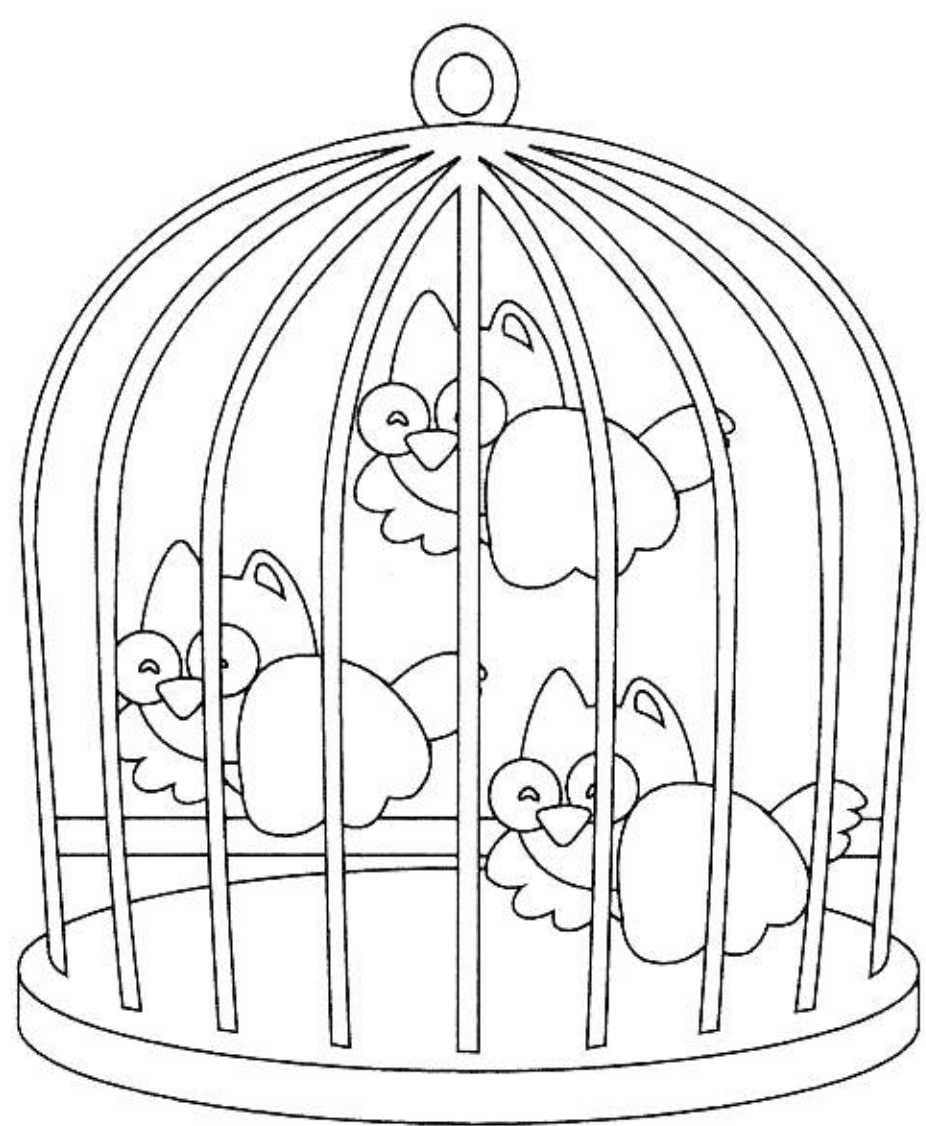

ก

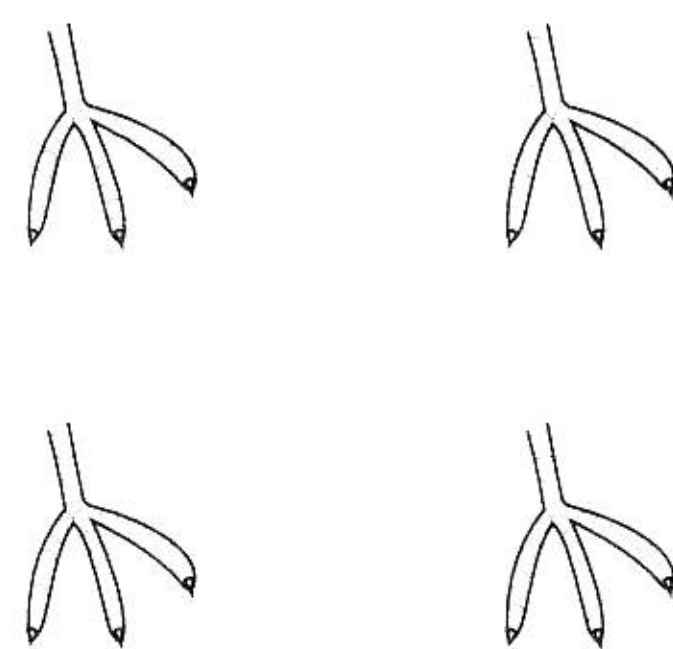

ข

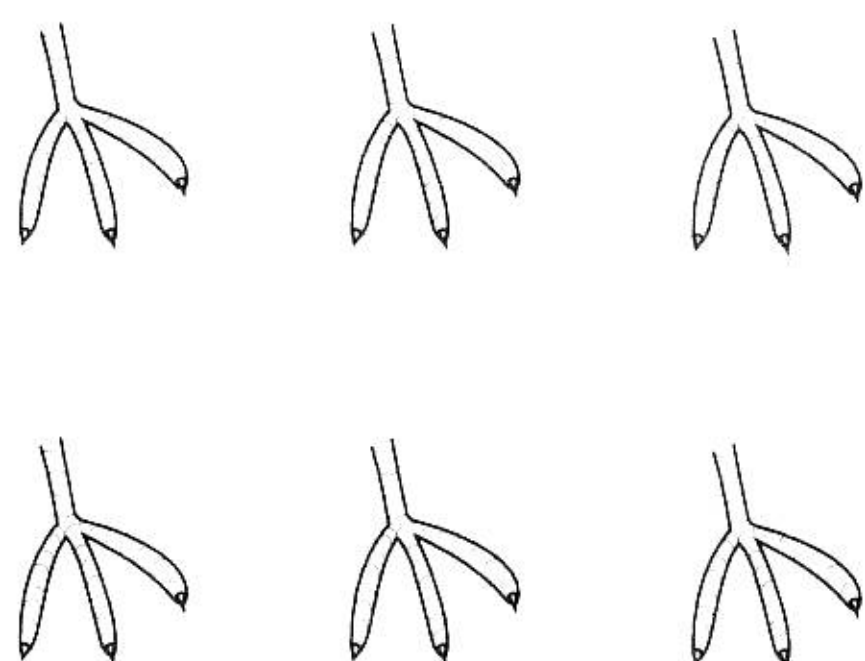

ค

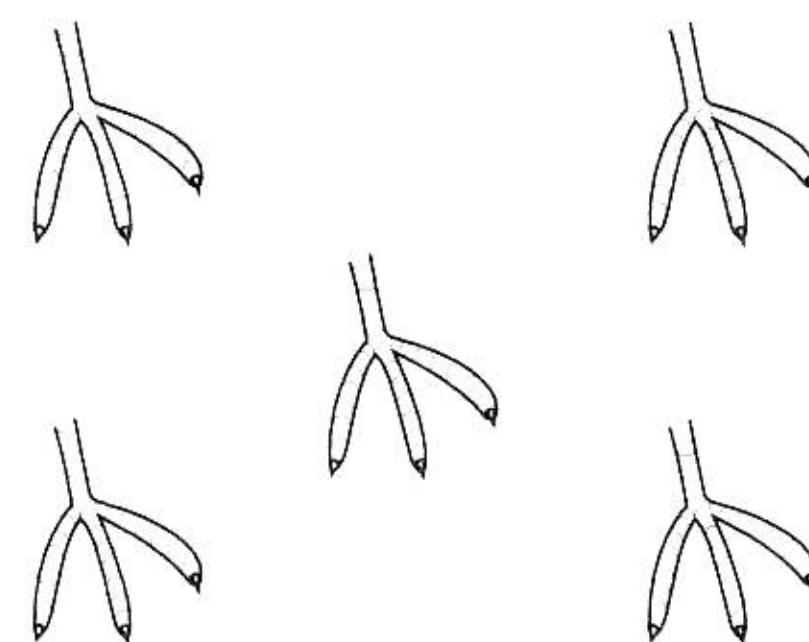

ง

8 คุณแม่มีช้อนและส้อม  
รวมแล้วนั้บได้ 6 อัน  
เอาจั้ดใส่จาน จานละ 1 คู่  
จะตั้องใส่จานกั้ใบ

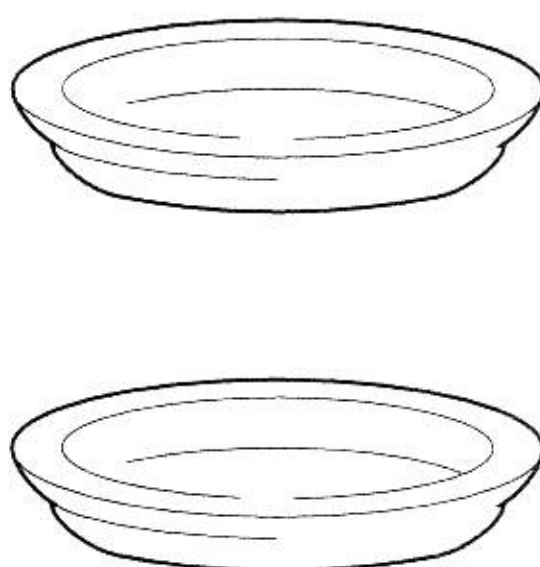
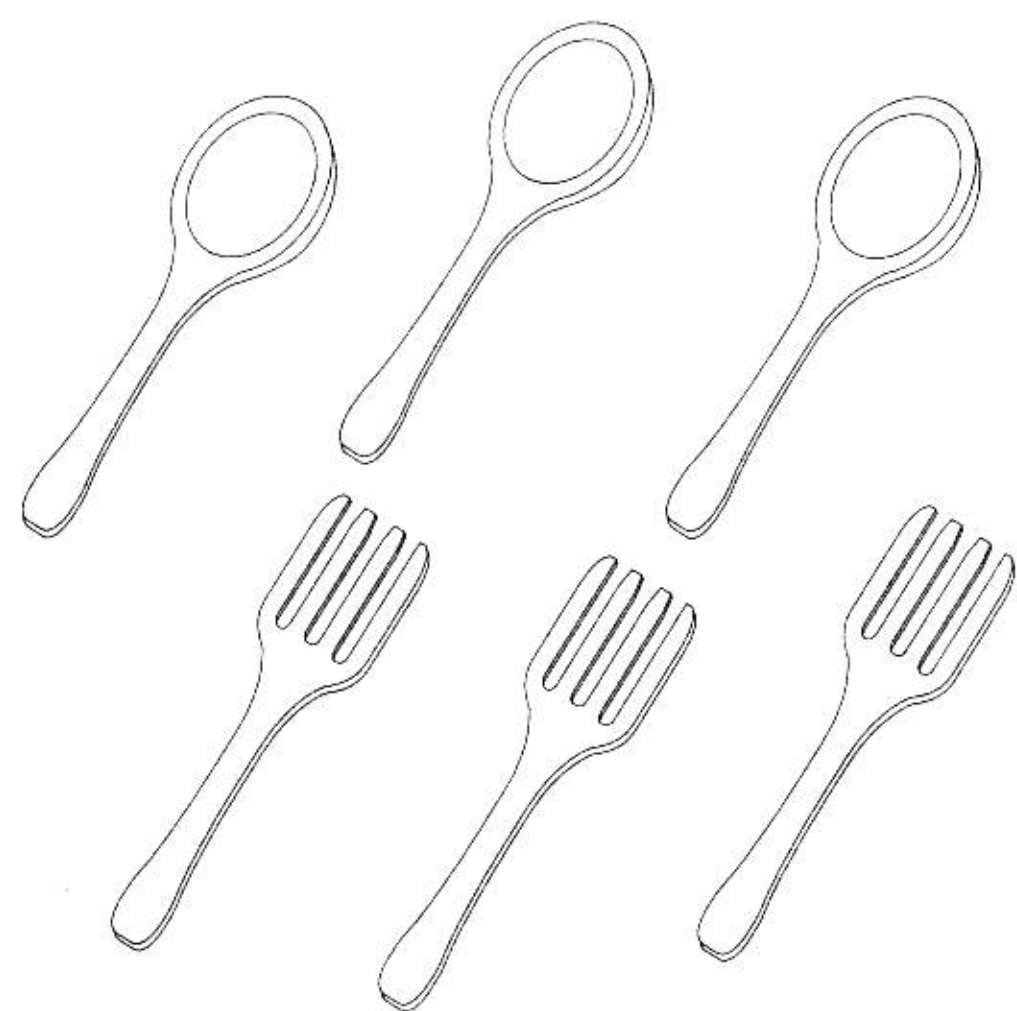

ก

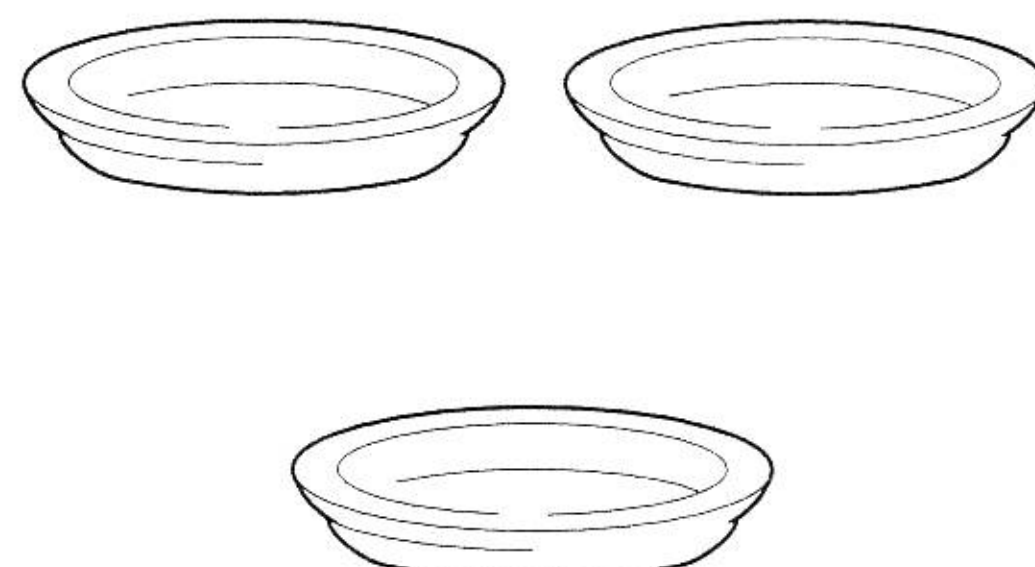

ข

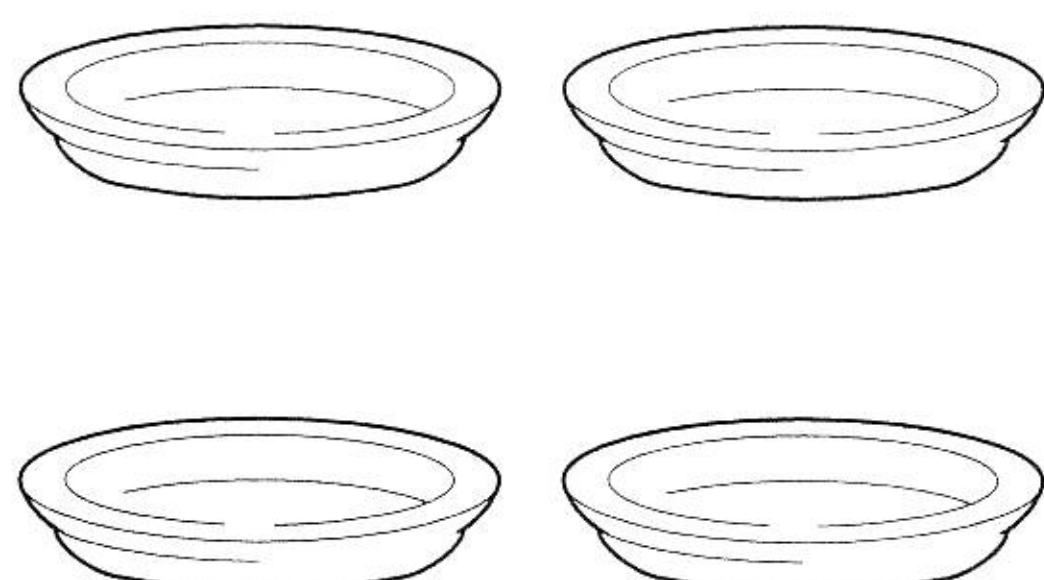

ค



ง

9 จั้บกบใส่อ่างไว้ 5 ตั๋ว  
รู่้งเข้านั้บกบได้ 2 ตั๋ว  
กบหายไ้กั้ตั๋ว

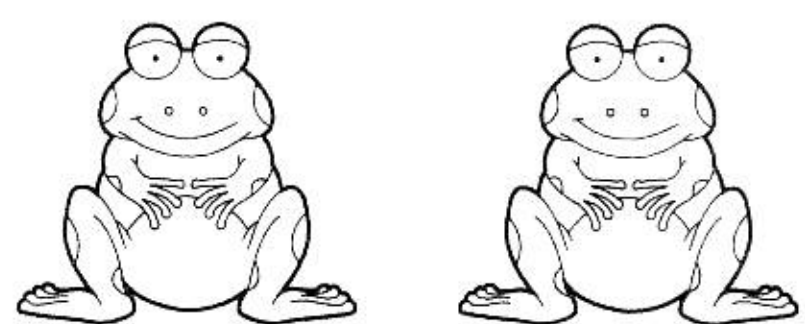
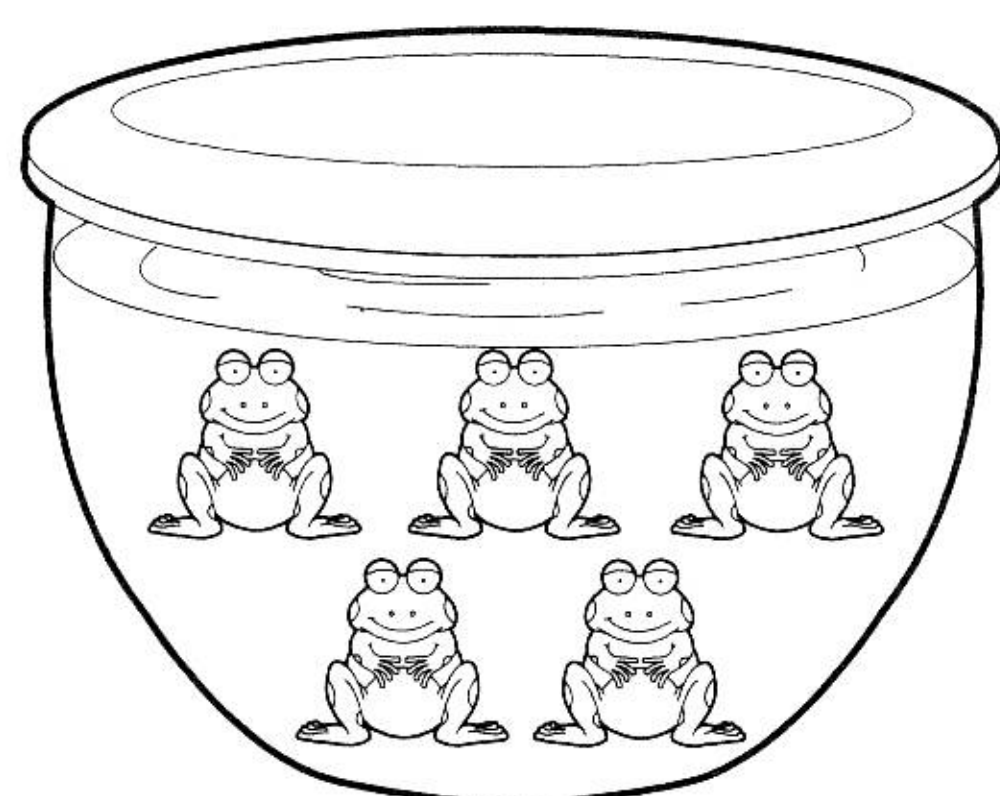

ก

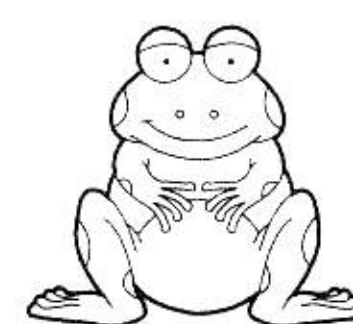

ข

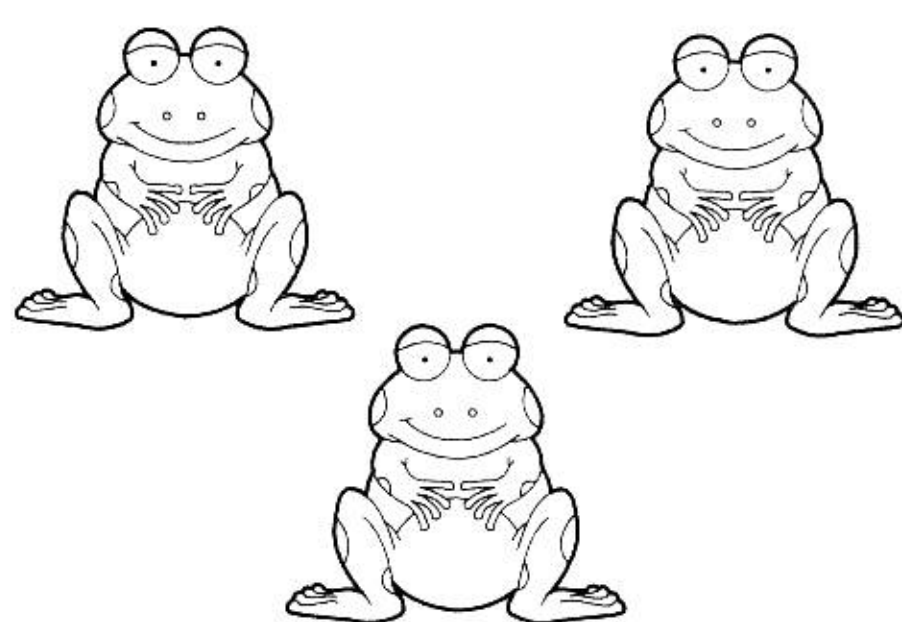

ค

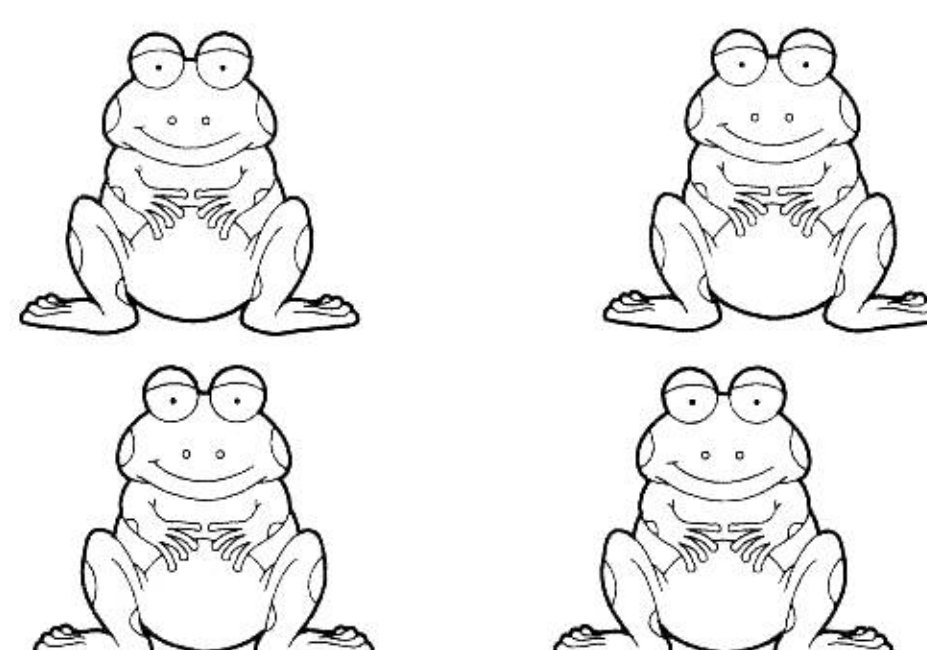

ง

10 ฉันมีเงิน 5 บาท  
ซื้อท็อฟฟี่เม็ดละ 1 บาท  
ได้กี่เม็ด

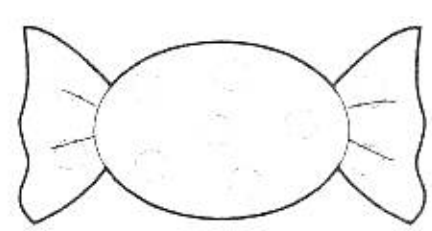
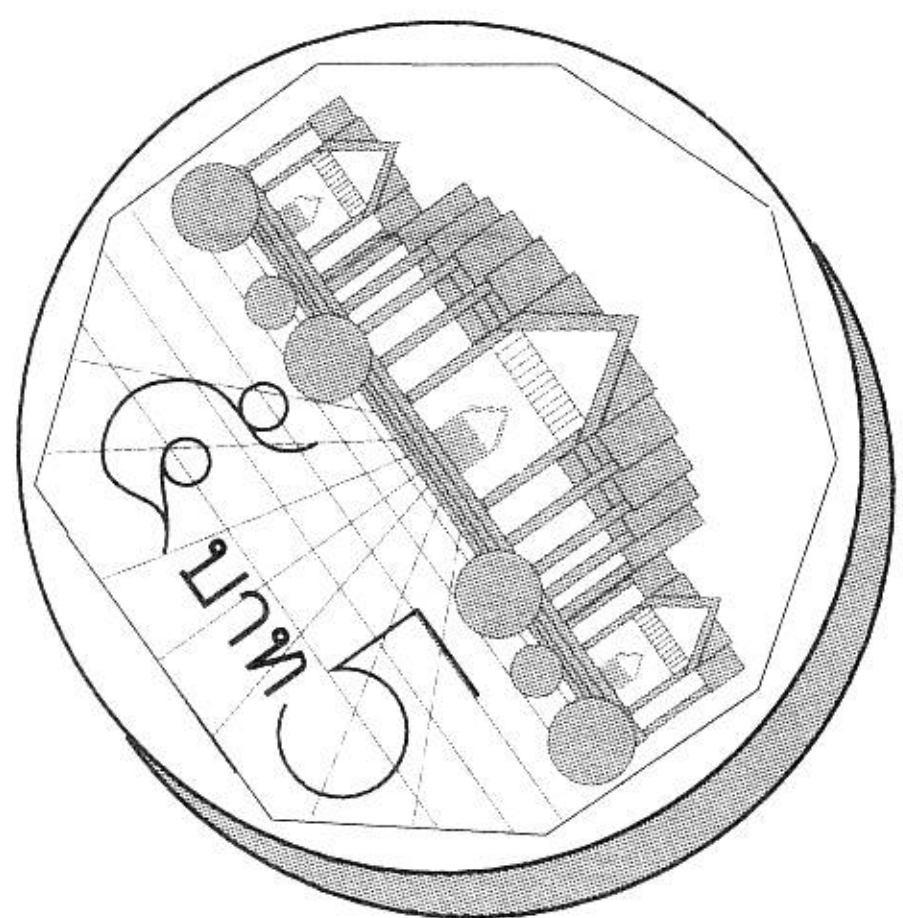

ก

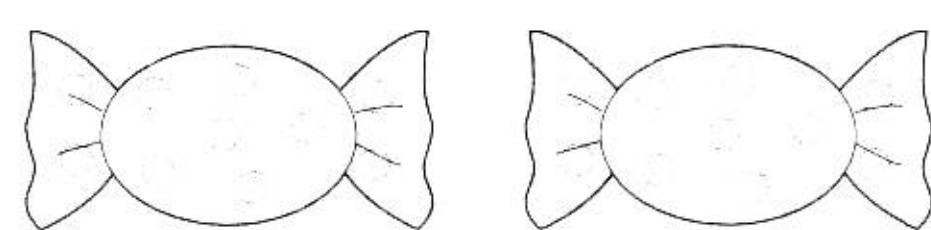

ข

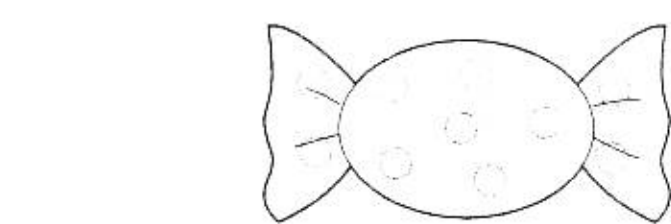
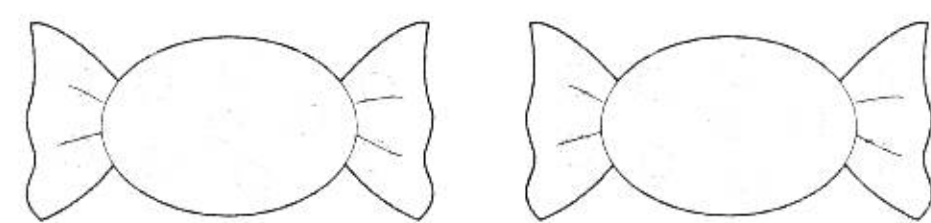

ค

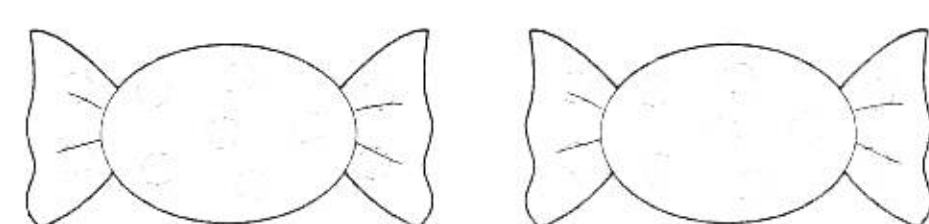
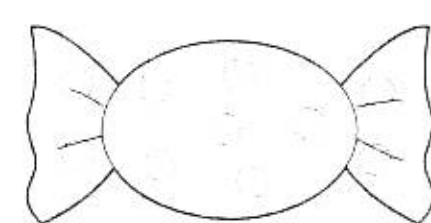
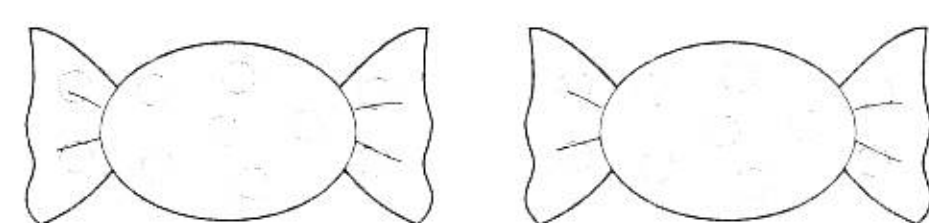

ง

11 จัดผลไม้ใส่ตะกร้า 3 ชนิด  
ชนิดละ 3 ผลให้มีจำนวน  
เท่าๆ กัน ต้องการผลไม้  
ชนิดใดมาเพิ่มอีกเท่าไร

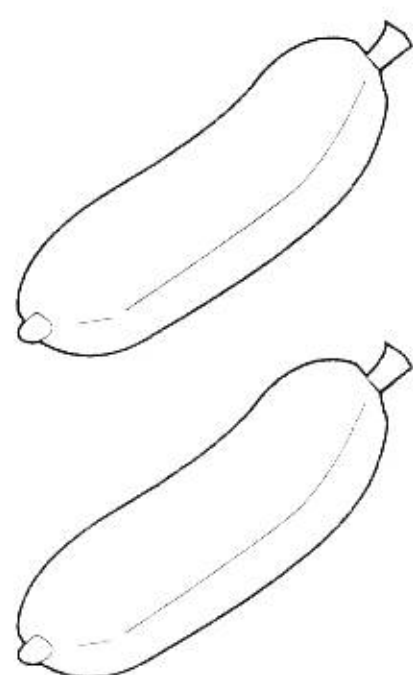
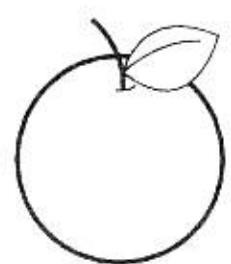
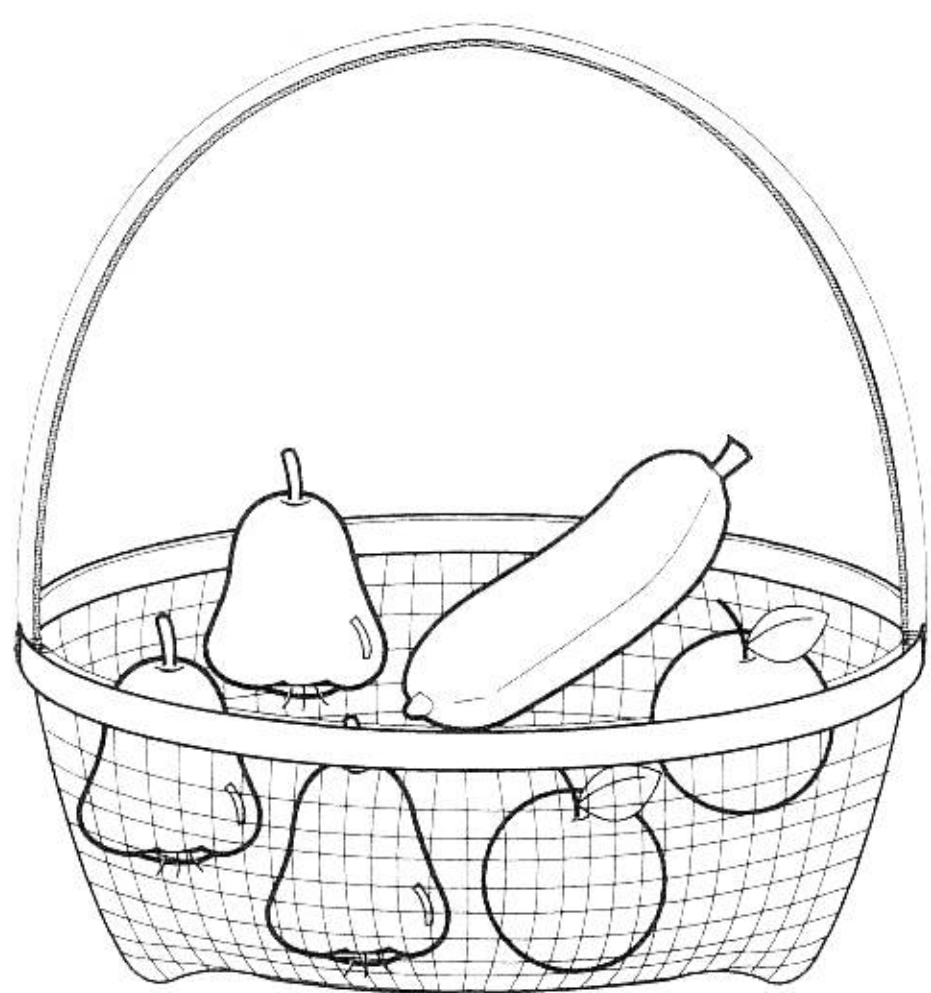

ก

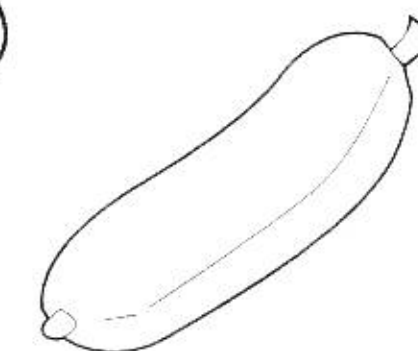
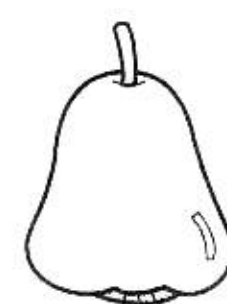
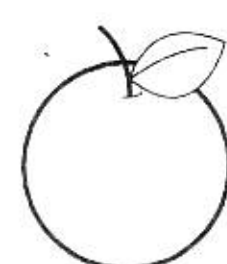

ข

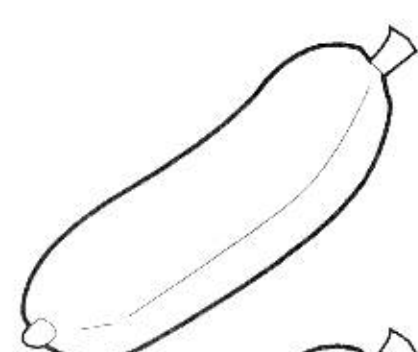
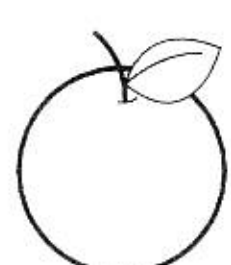

ค

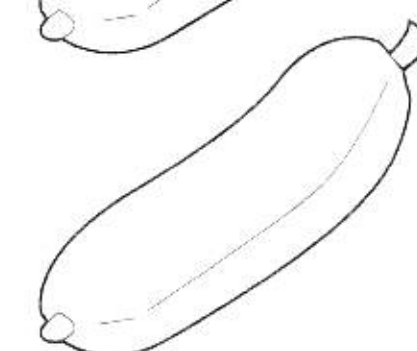
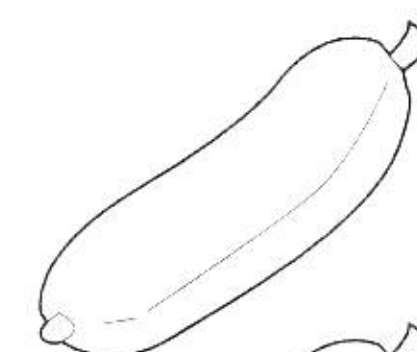
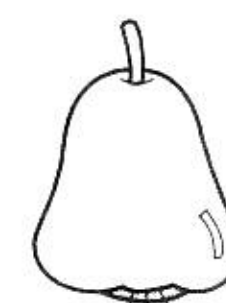

ง

12 เลี้ยงแมวไว้ 3 ตัว สุนัข 2 ตัว  
ต่อมาแมวตายไป 1 ตัว  
สุนัขออกลูกมาอีก 3 ตัว  
เวลานี้มีแมวและสุนัขกี่ตัว

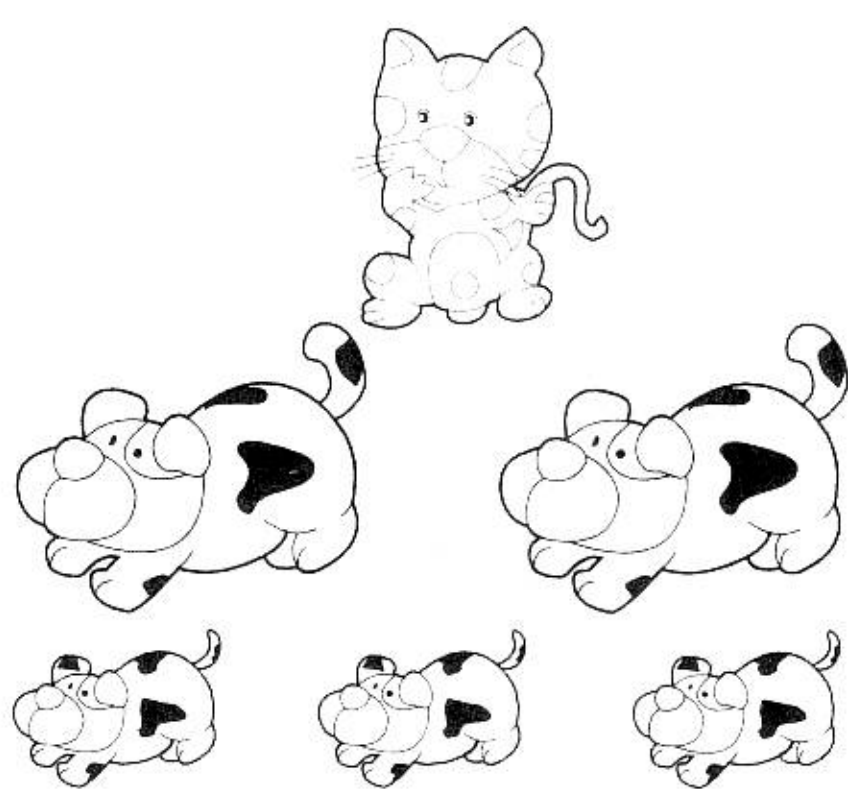
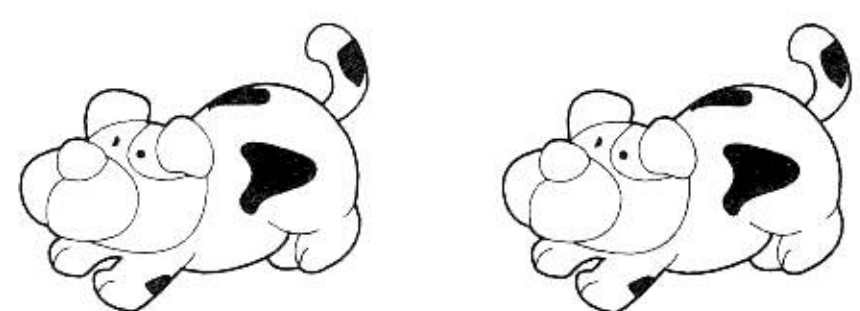

ก

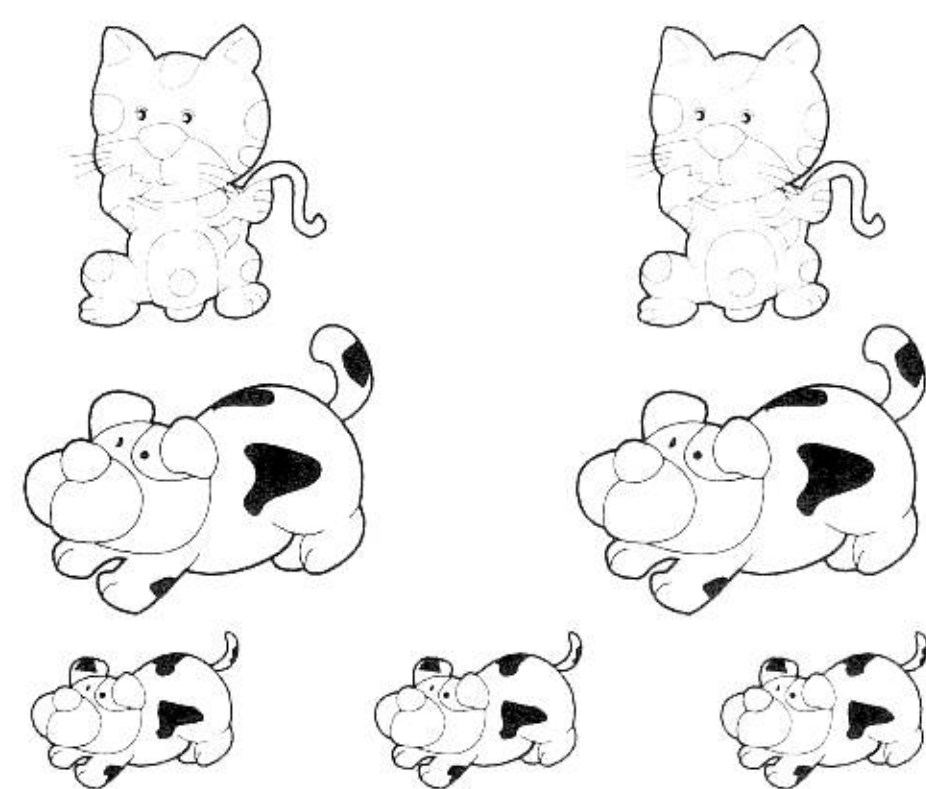

ข

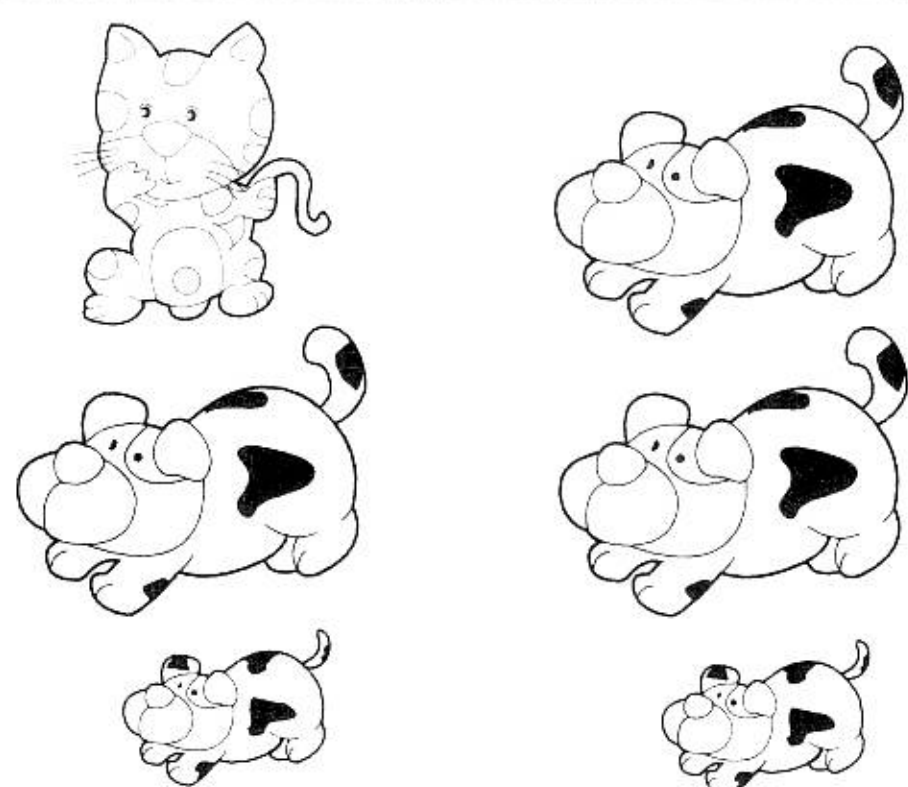

ค

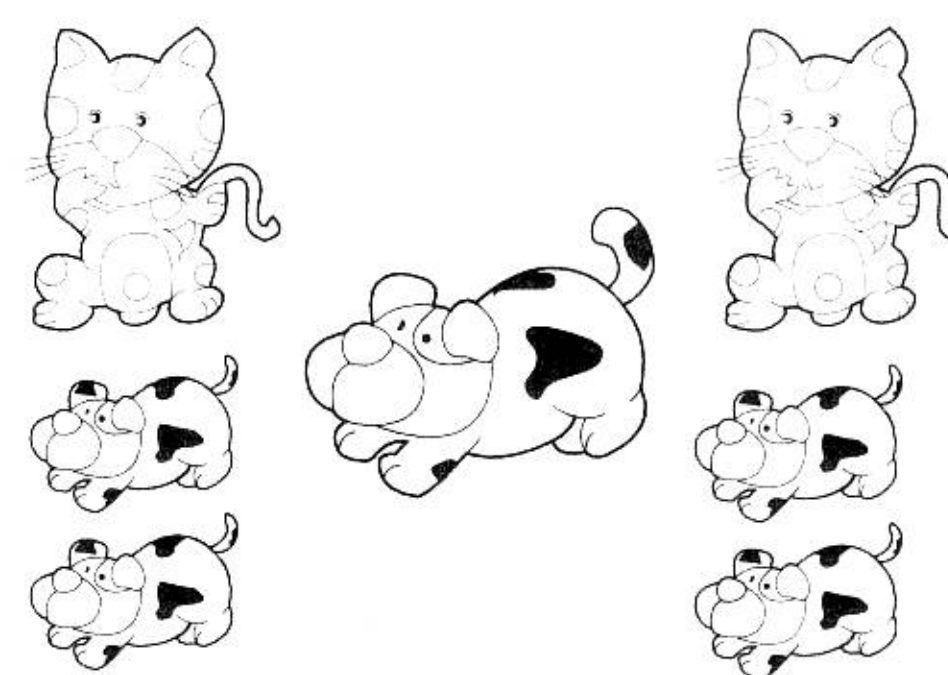

ง

13

มีถ้วยกาแฟ 5 ใบ มีช้อนอยู่ 3 คัน ทำถ้วยแตกไป 3 ใบ แล้วซื้อช้อนมาเพิ่ม 4 คัน จะมีถ้วย + ช้อน ทั้งหมดเท่าไร

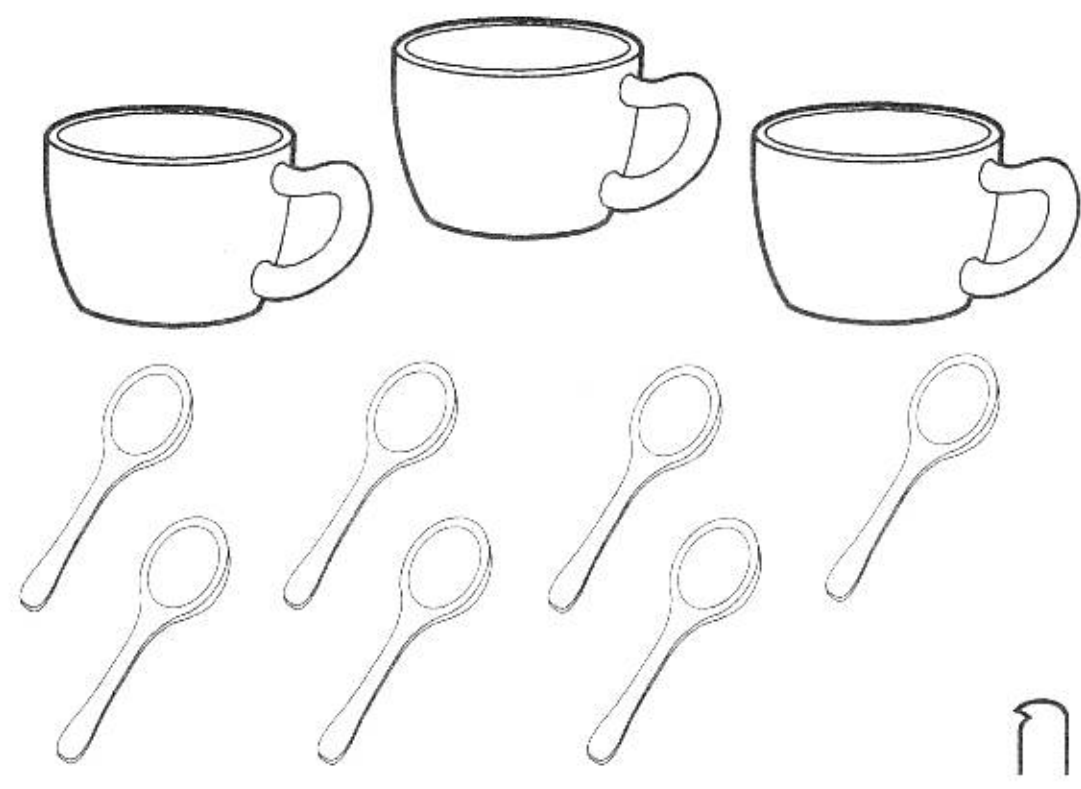
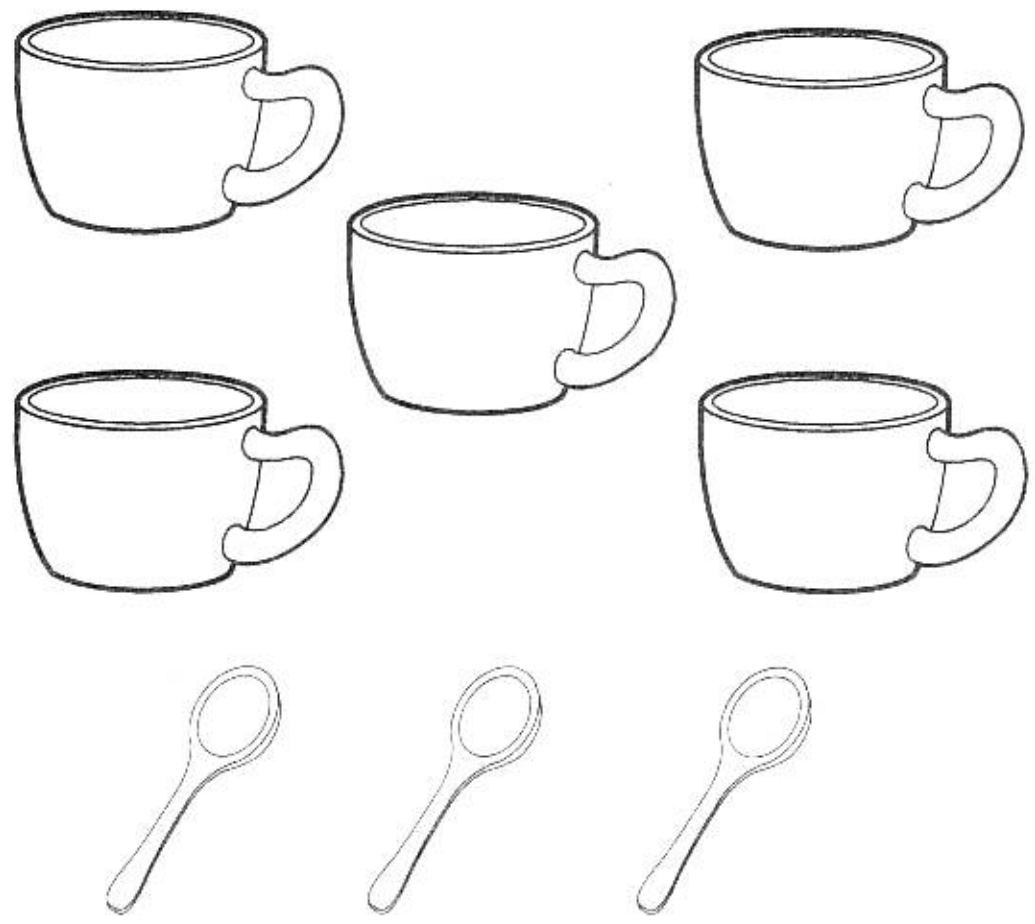

ก

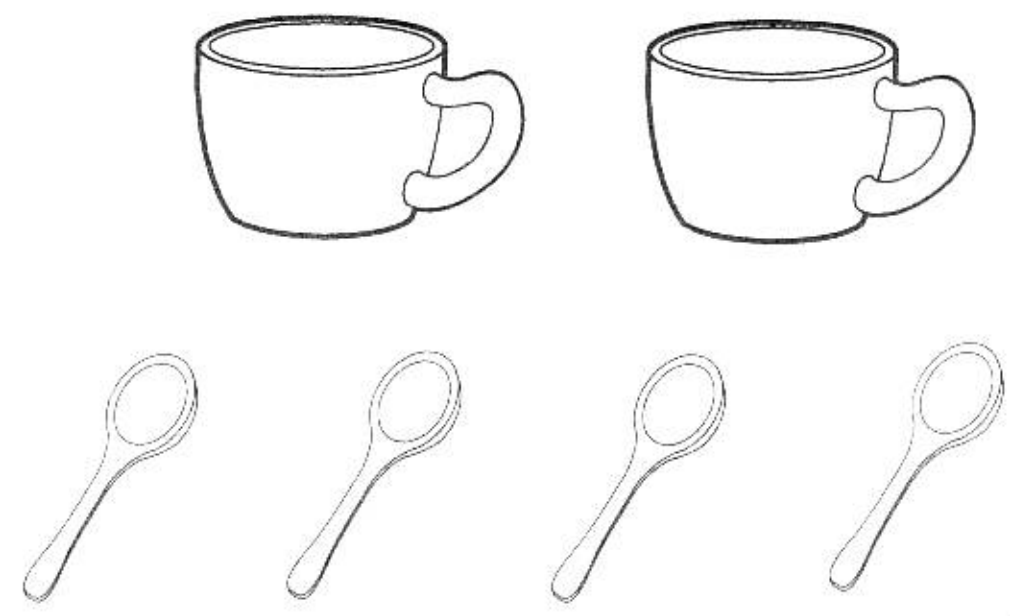

ข

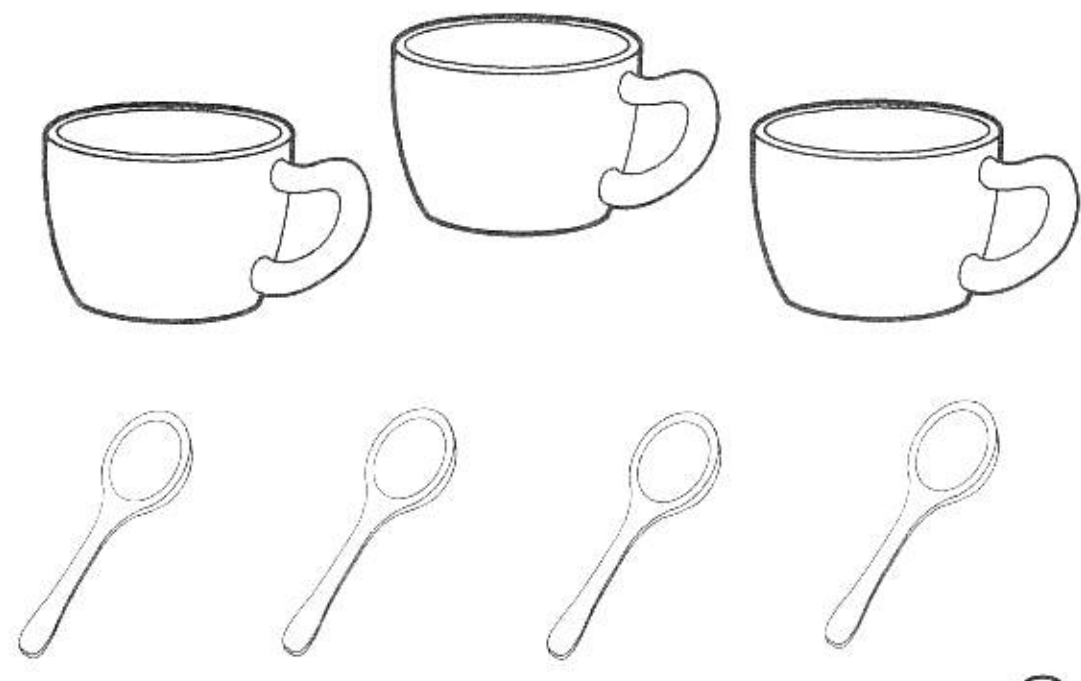

ค

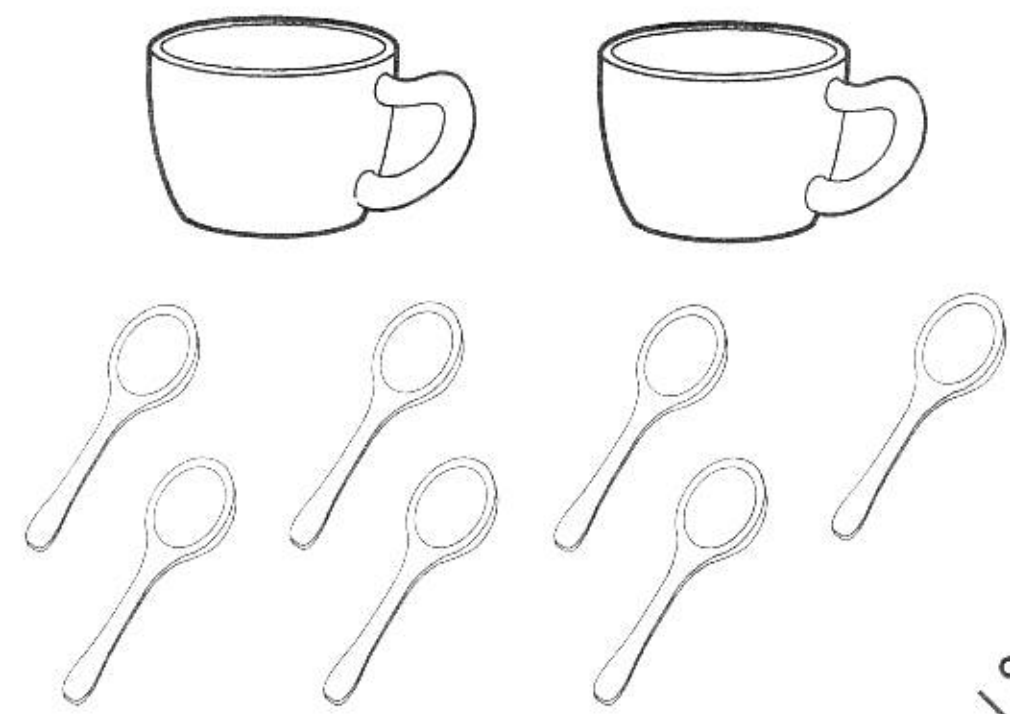

ง

14

ในกล่องดินสอมีดินสอ 4 แท่ง มียางลบ 2 ก้อน เอาดินสอออกไปเหลา 1 แท่งและเอายางลบมาใช้อีก 2 ก้อนในกล่องจะมีดินสอและยางลบเท่าไร

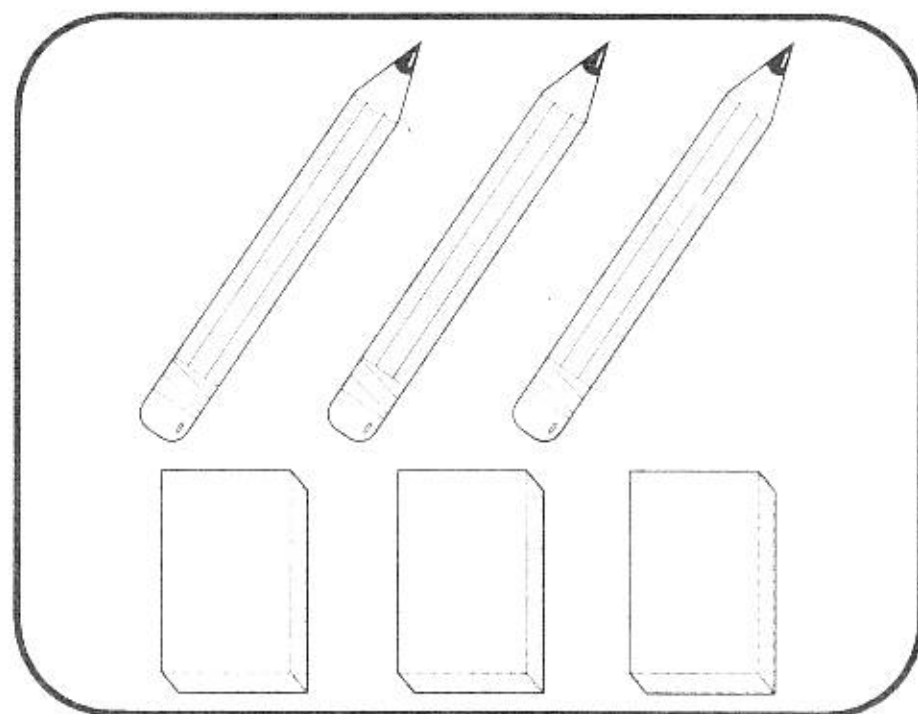
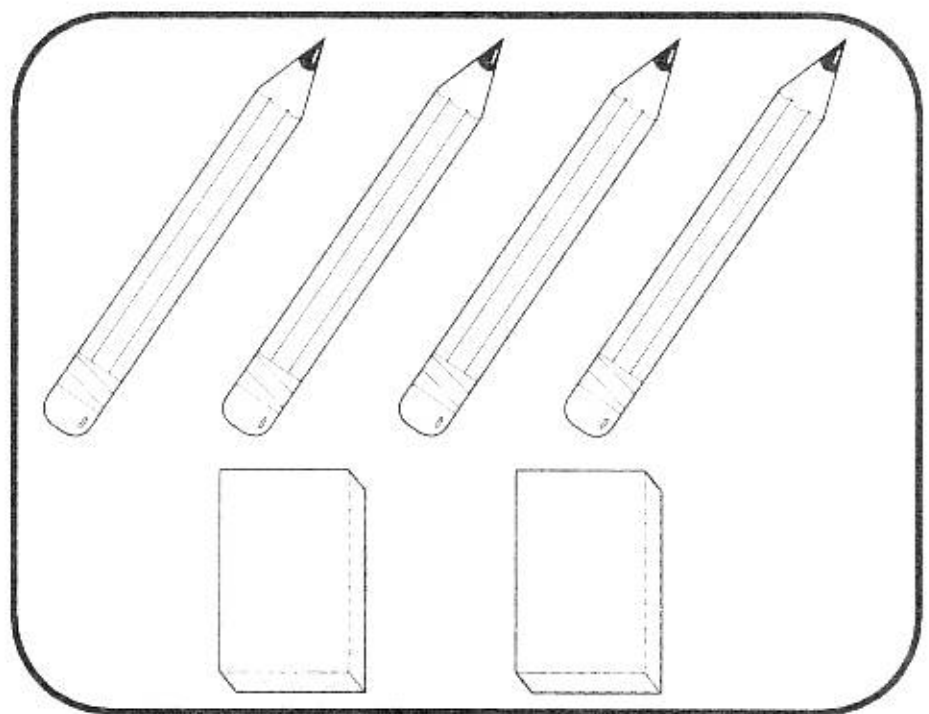

ก

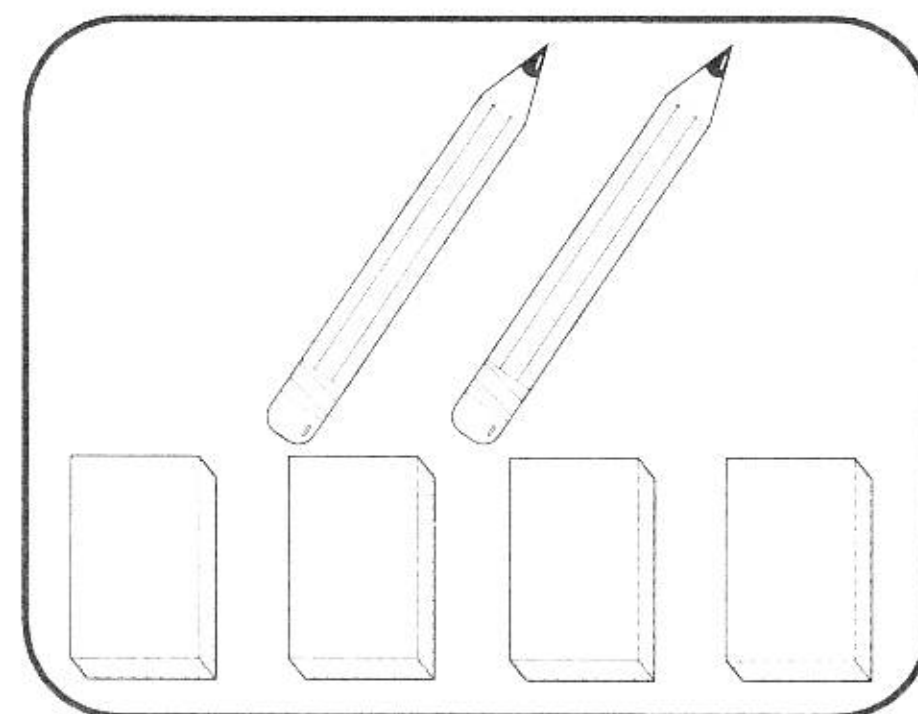

ข

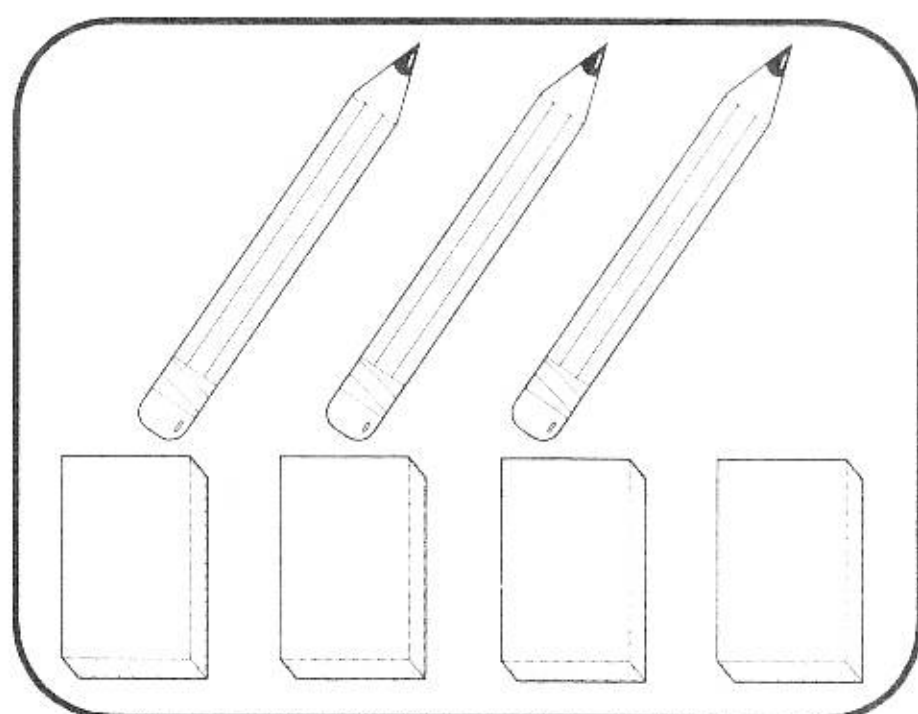

ค

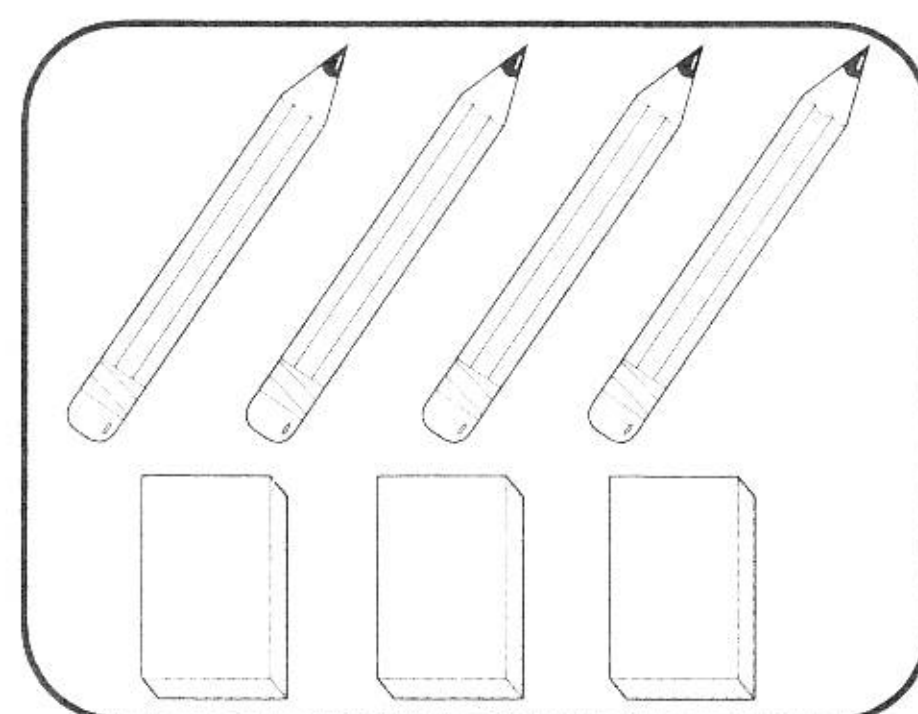

ง

15

แจกันมีดอกไม้ 5 ดอก เอาดอกเหี่ยวออกไป 4 ดอก แล้วซื้อใหม่เพิ่มใหม่ 5 ดอก ในแจกันจะมีดอกไม้กี่ดอก

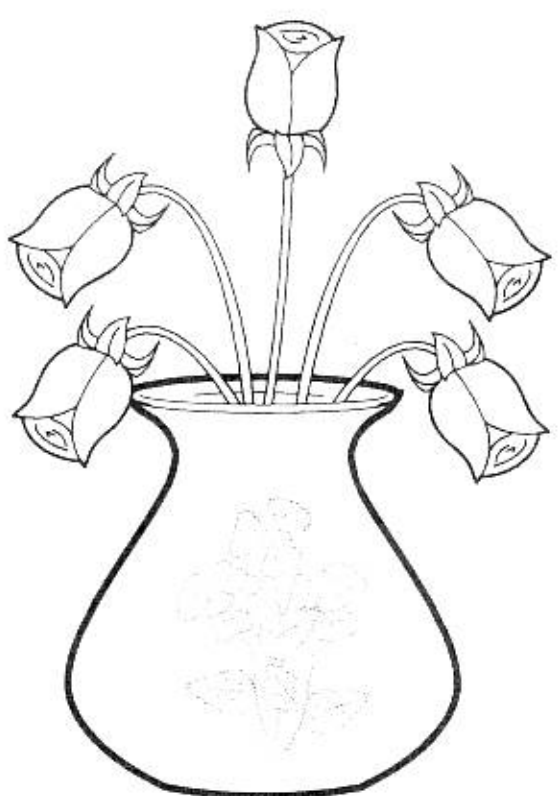

ก

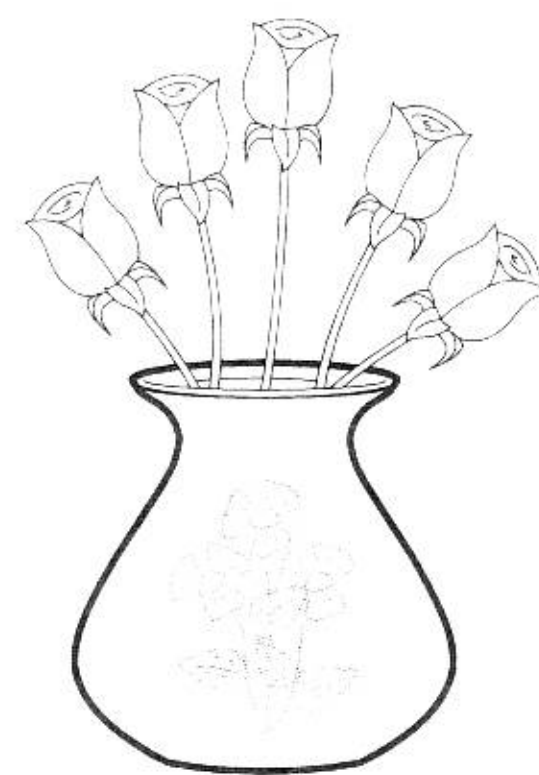

ข

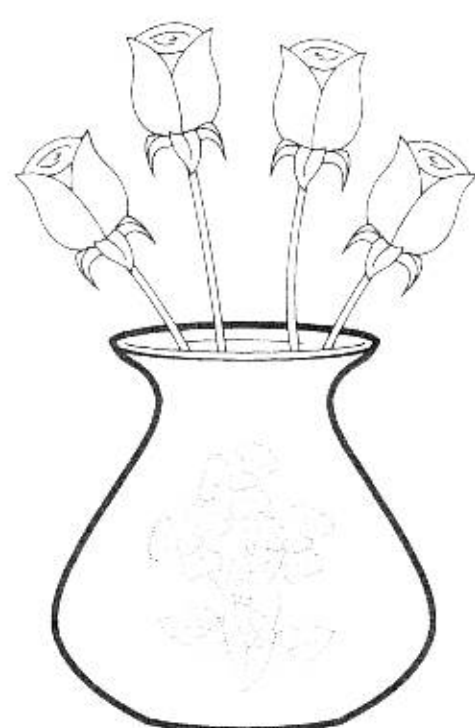

ค

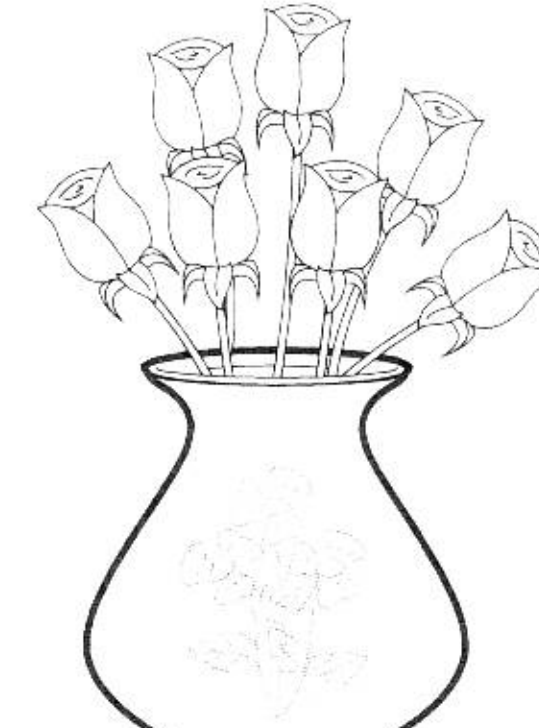

ง

**16** องุ่นพวงหนึ่งมี 10 ลูก  
 นำไป 3 ลูก  
 ให้นำไป 3 ลูก  
 เหลือไว้กินเองกี่ลูก

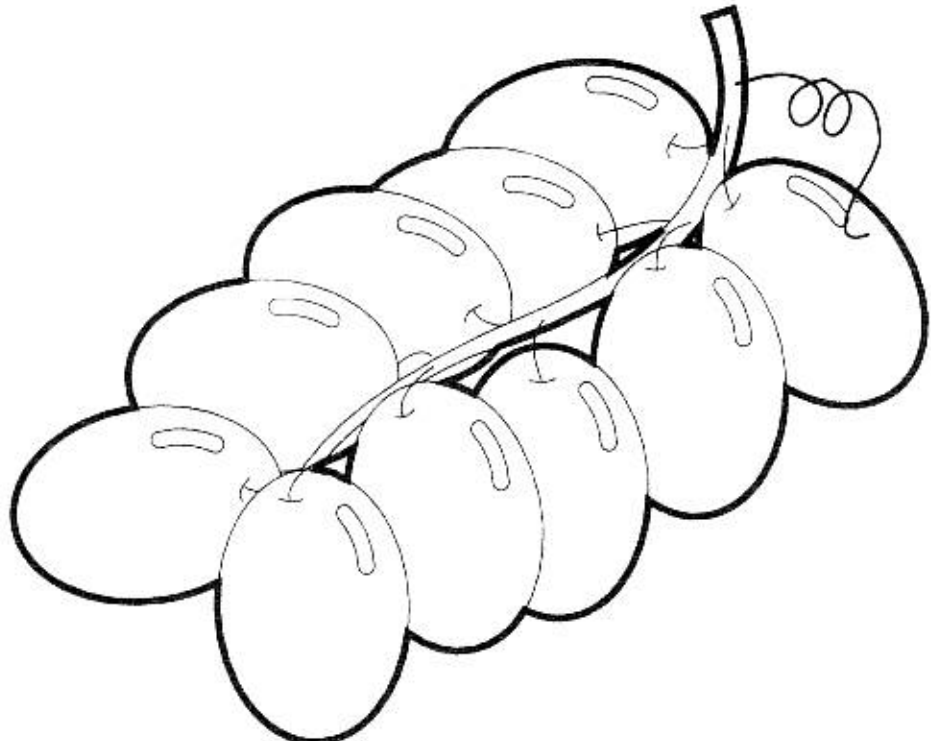
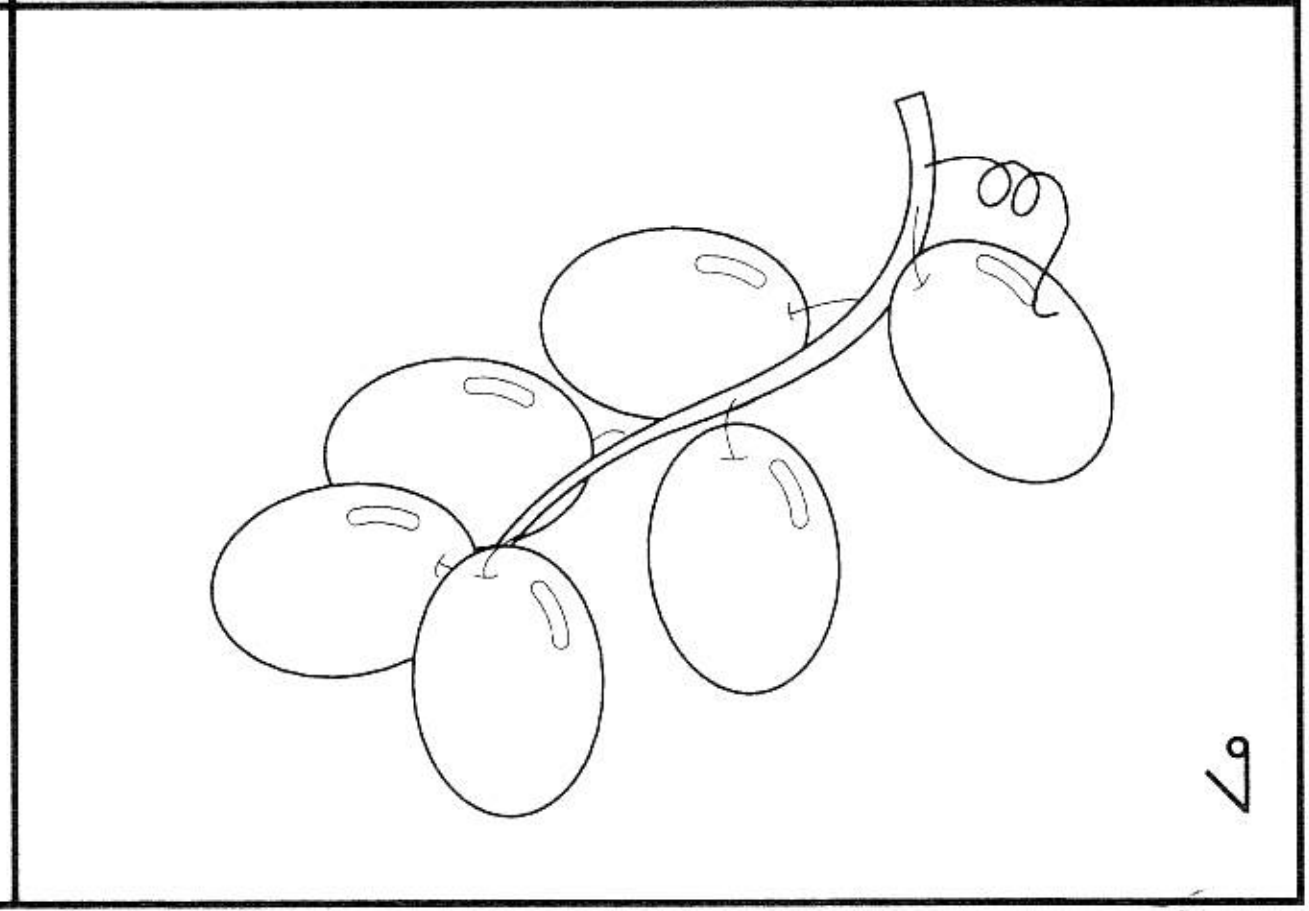
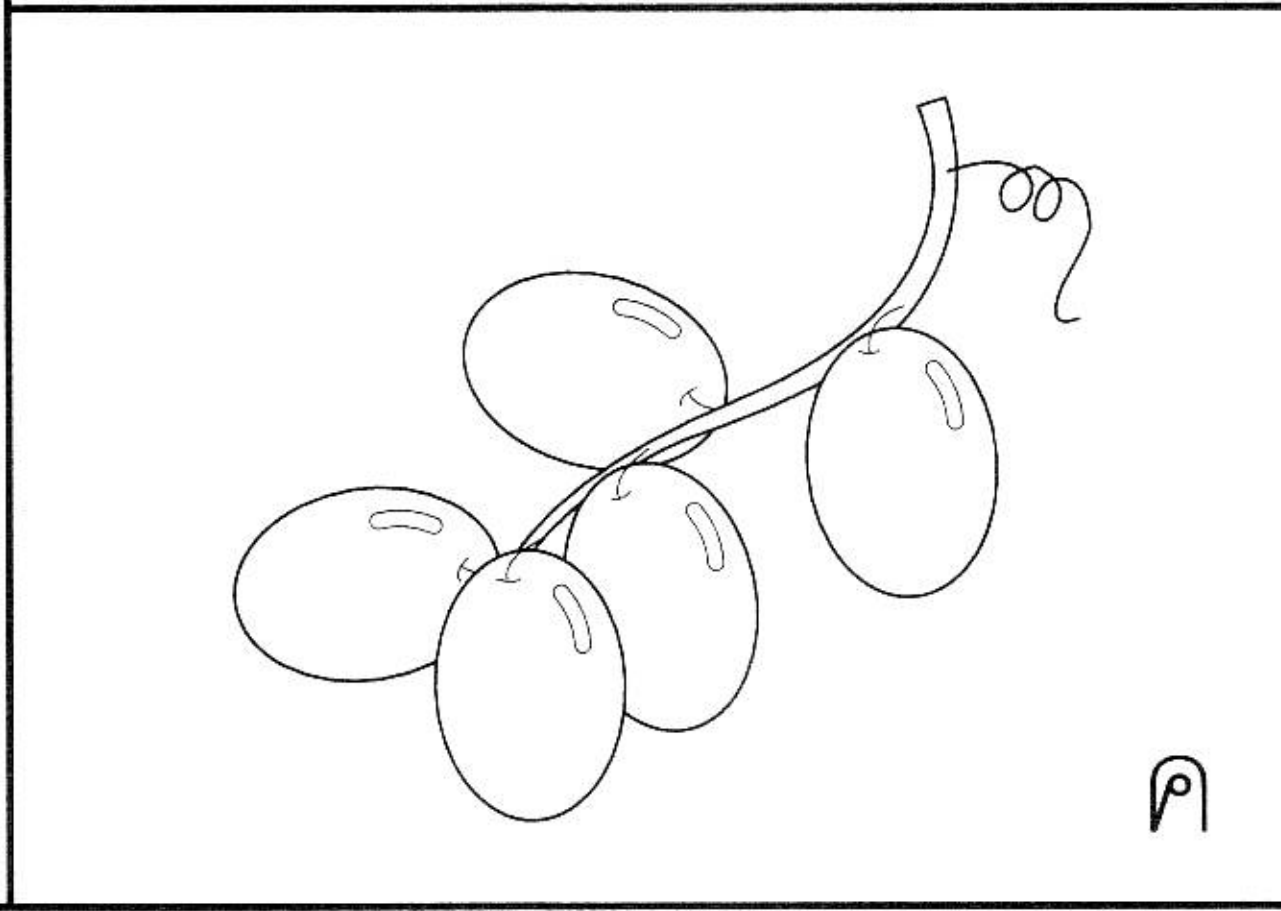
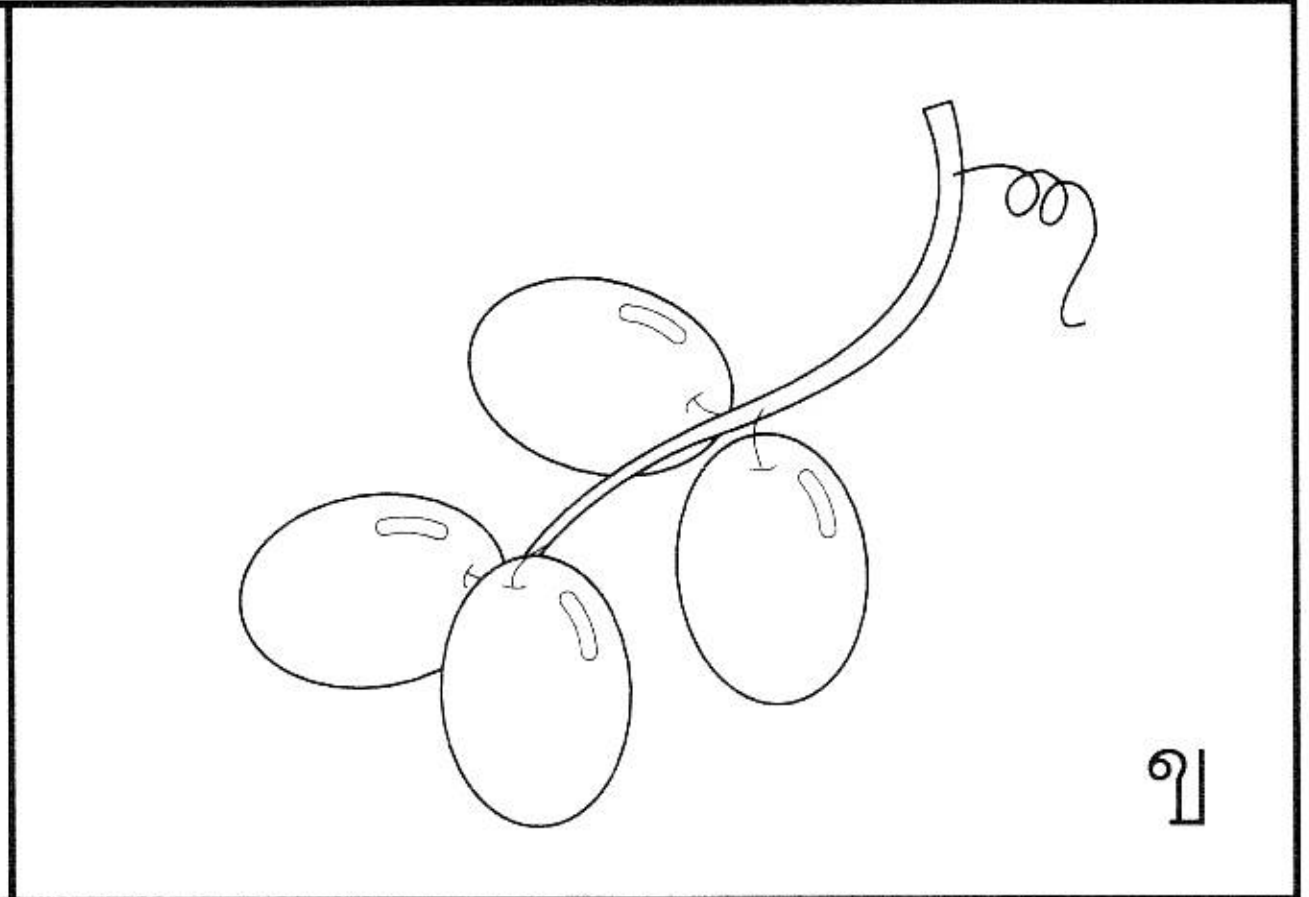
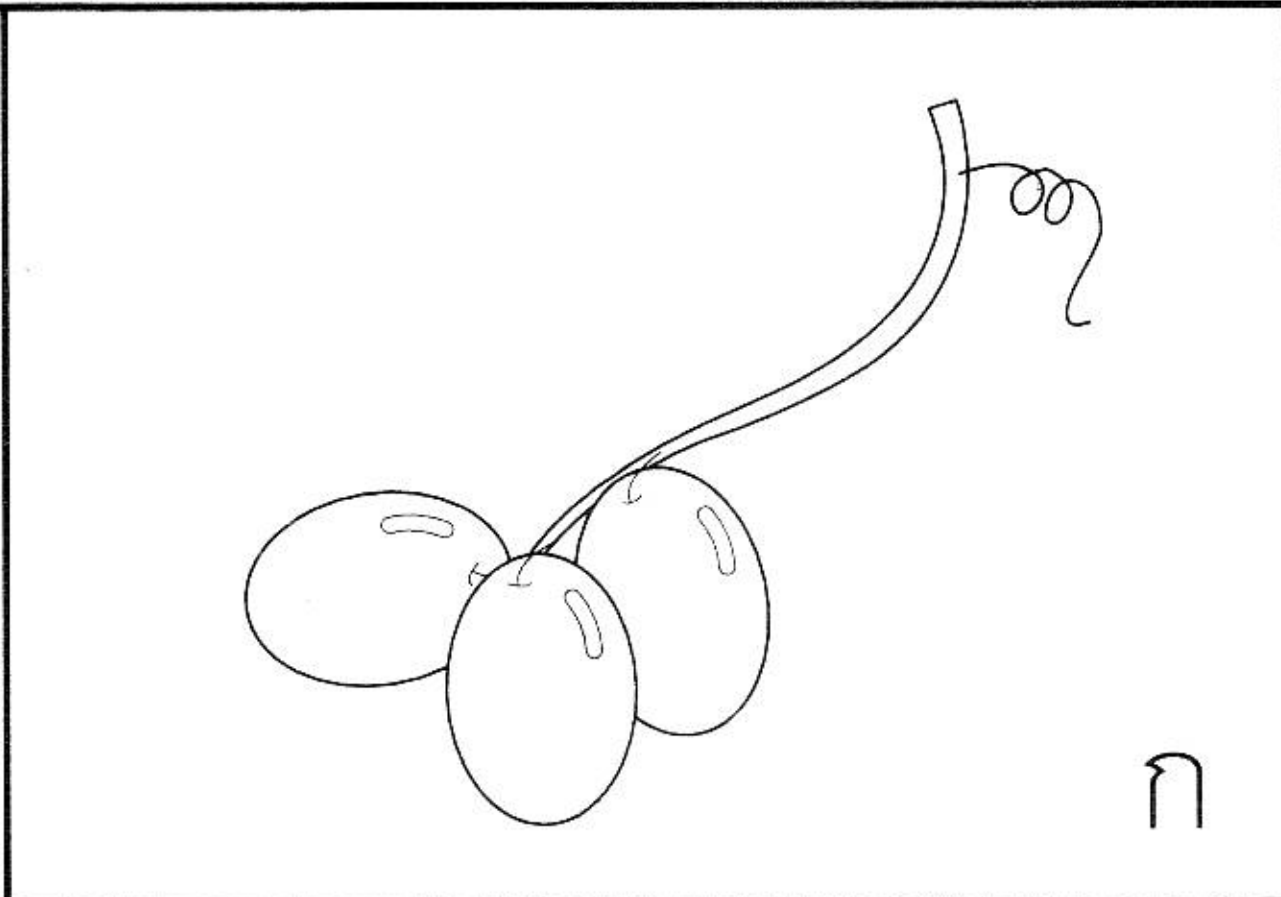
**17** ฉันมีลูกโป่ง 3 ใบ  
 เพื่อนให้มาอีก 4 ใบ  
 ทำแตกไป 2 ใบ  
 เหลือลูกโป่งกี่ใบ

**18** แม่ซื้อไข่มา 5 ฟอง ปลา 2 ตัว  
 และมะเขือ 3 ผล เอาปลา ไข่  
 และมะเขือมาทำกับข้าวกิน  
 อย่างละ 2 ยังคงมีกับข้าว  
 เหลืออีกจำนวนเท่าไร

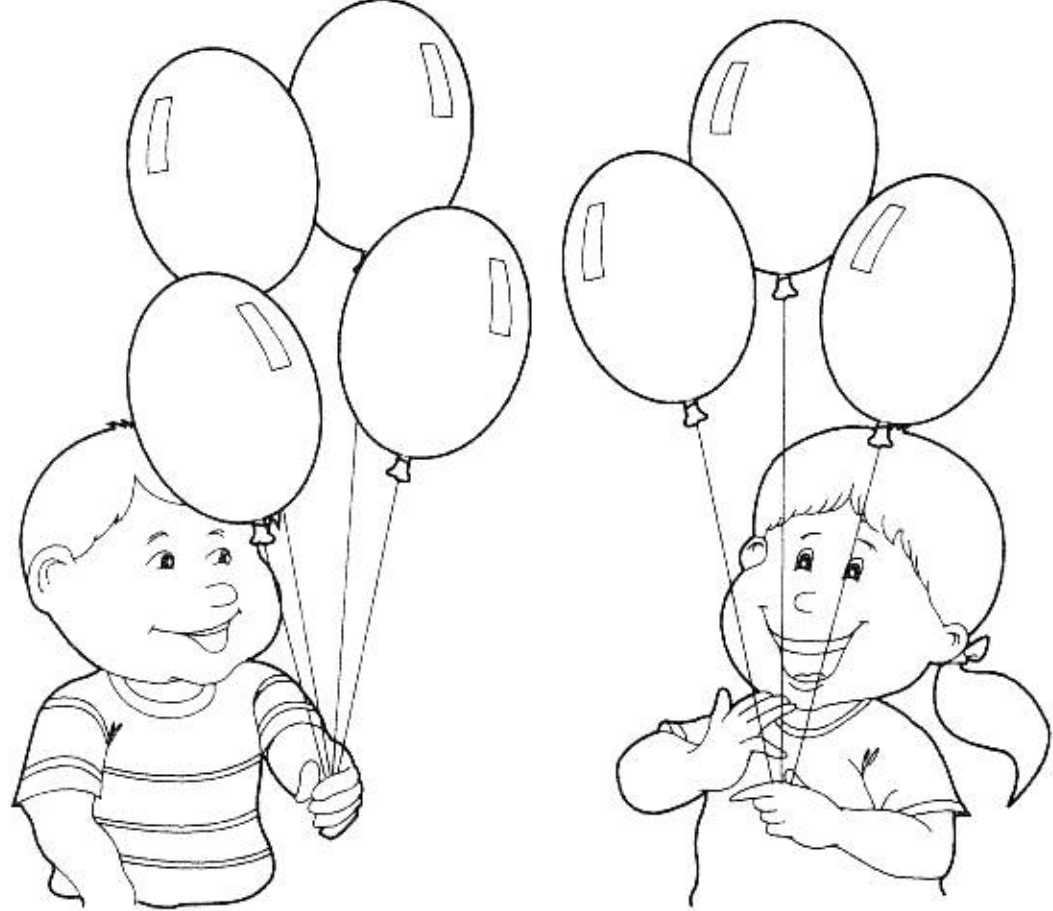
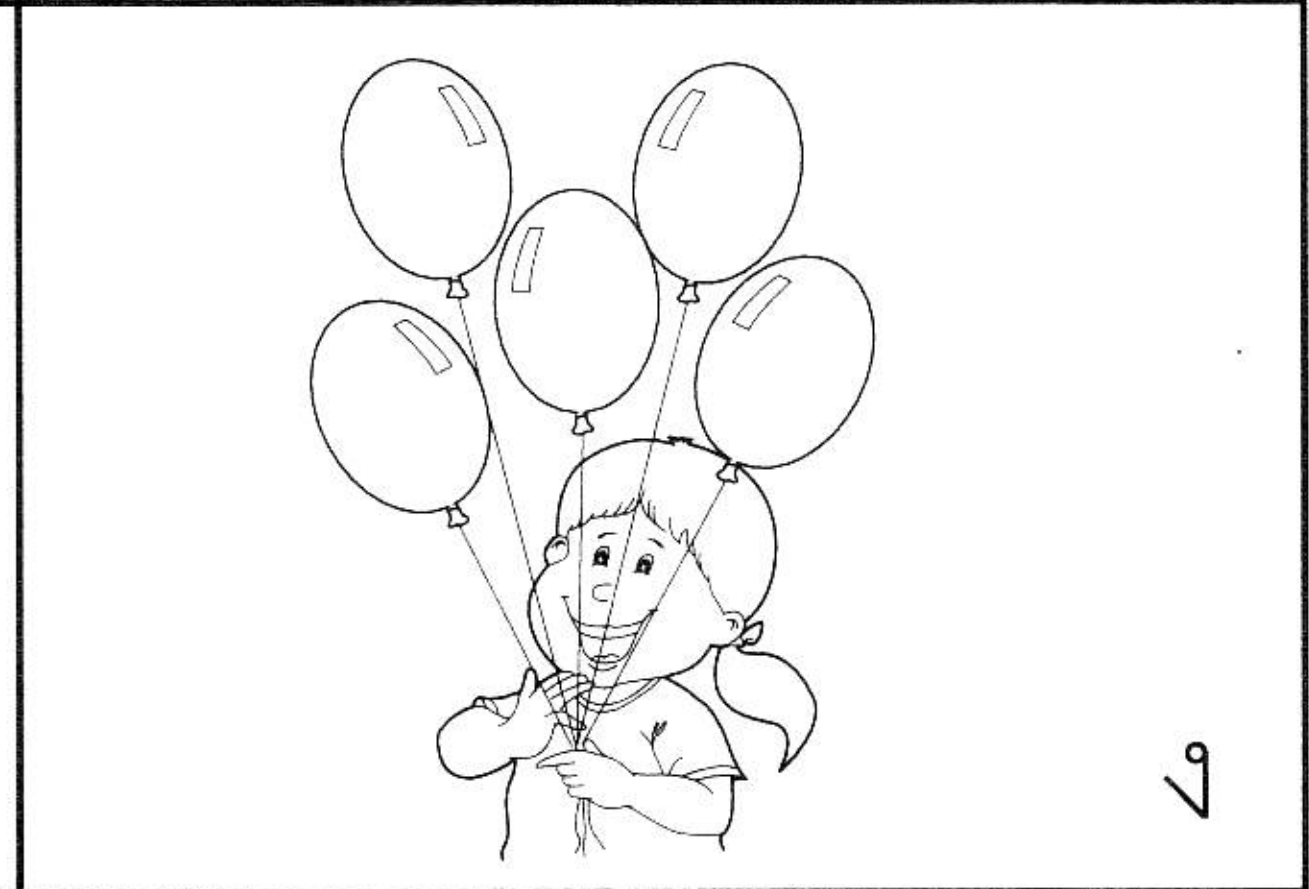
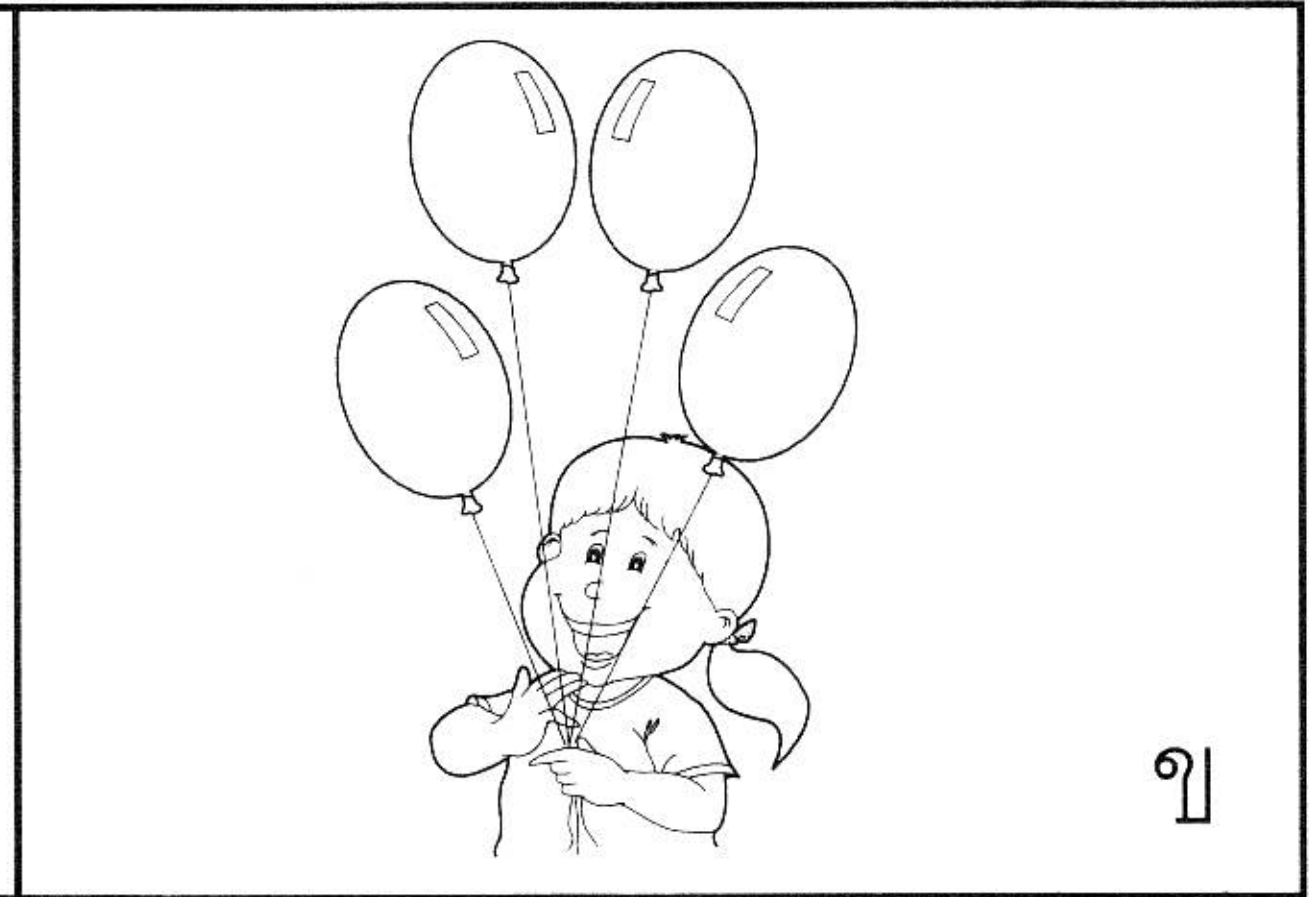
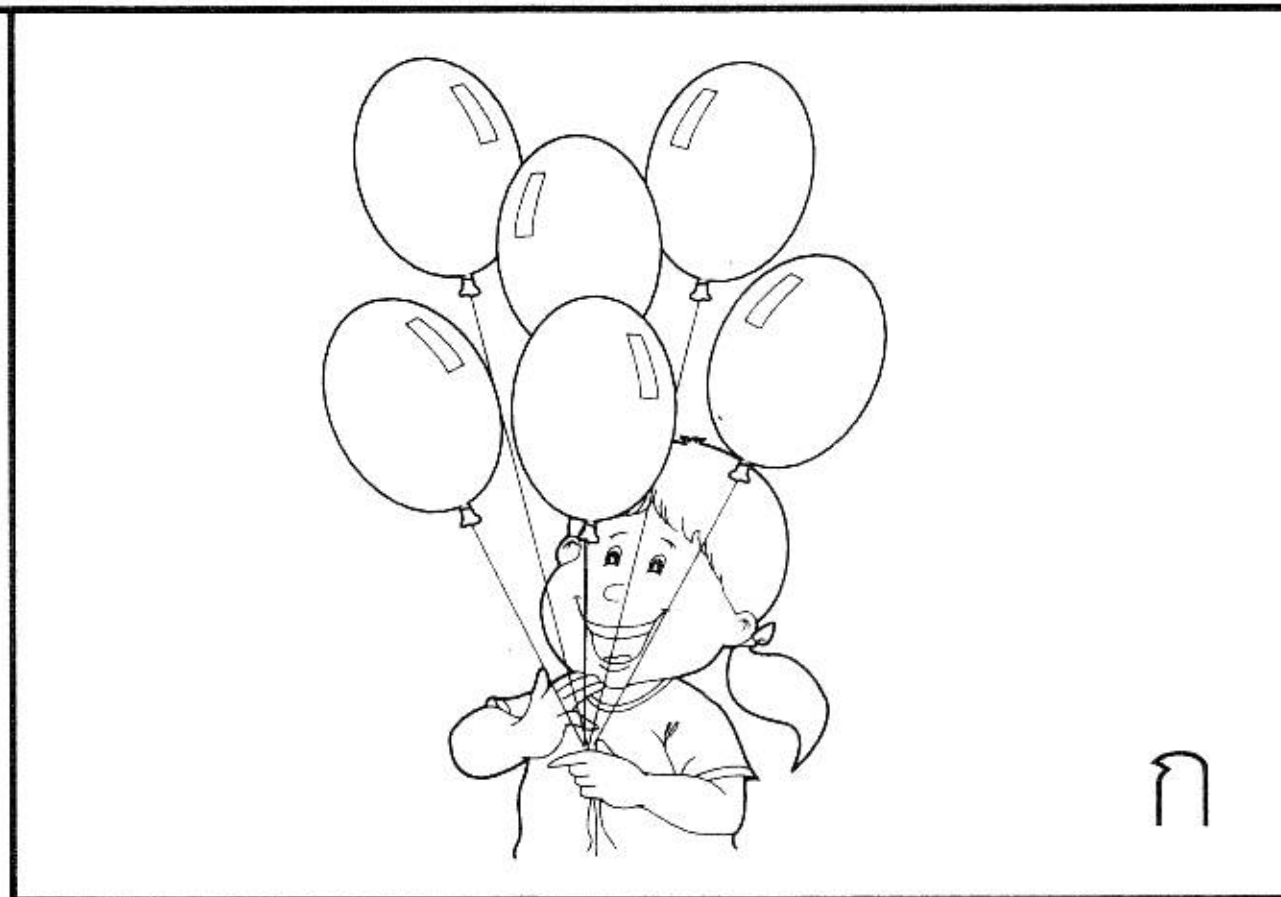
19 น่องวาดภาพ 🍏 3 บรรทัด  
 บรรทัดละ 2 ภาพ  
 ถ้าวาดเพิ่มบรรทัดละ 1 ภาพ  
 จะต้องวาดทั้งหมดกี่ภาพ

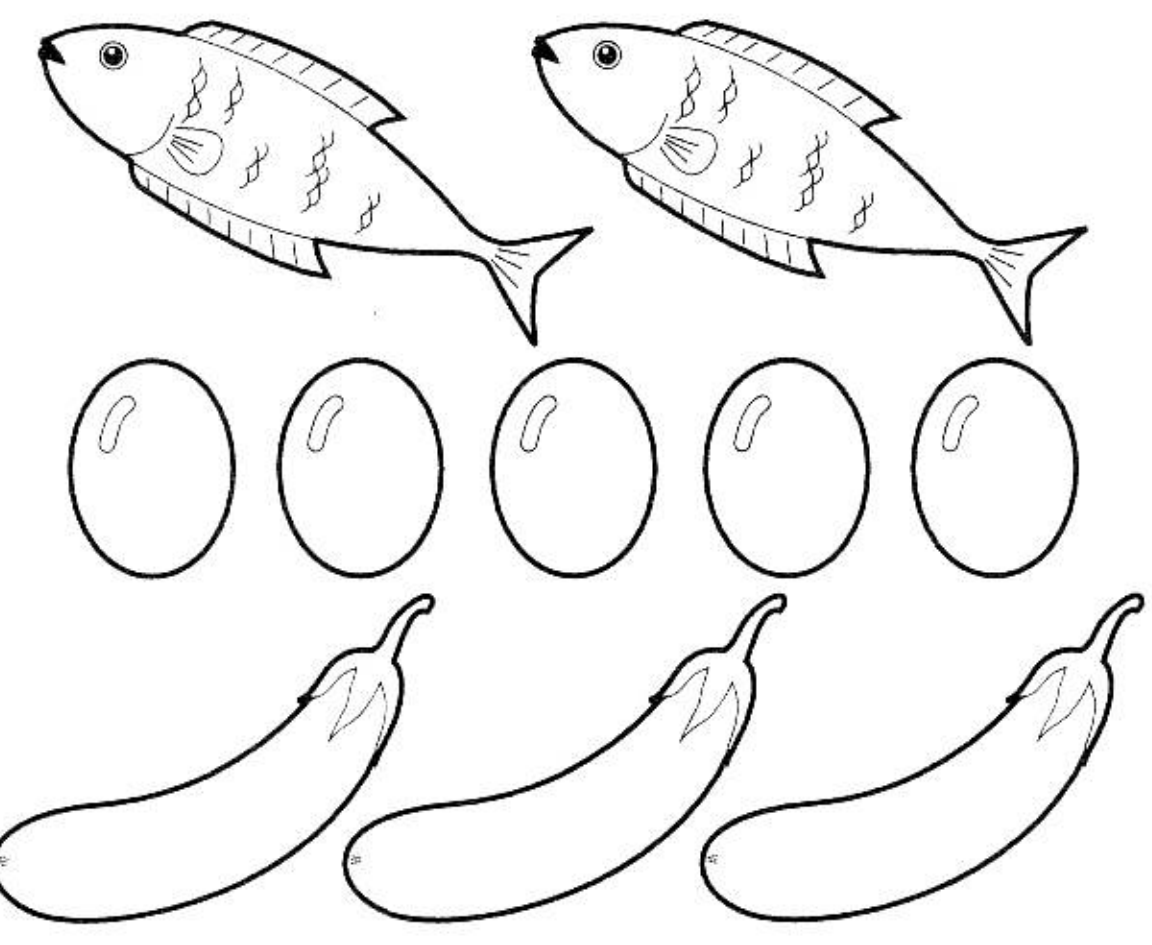
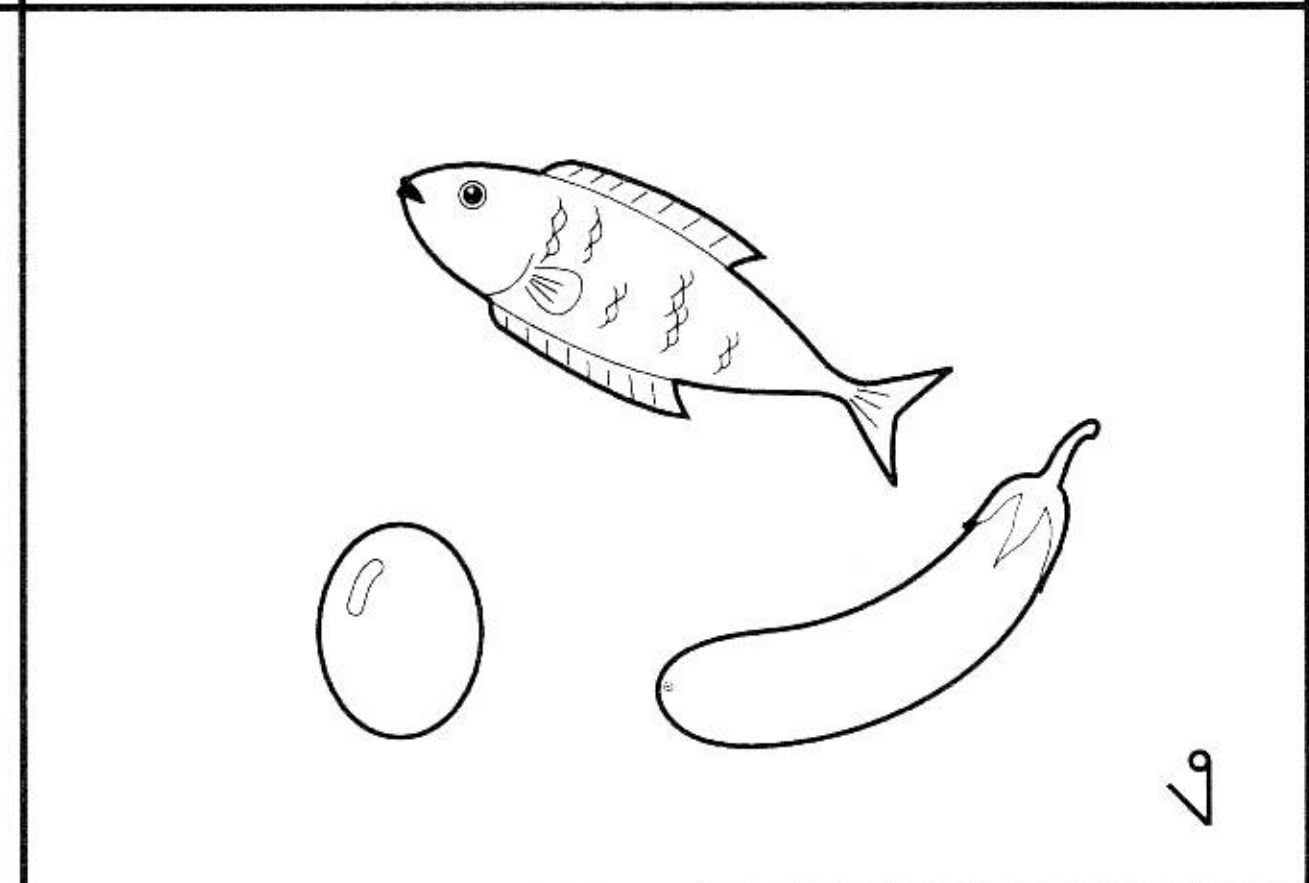
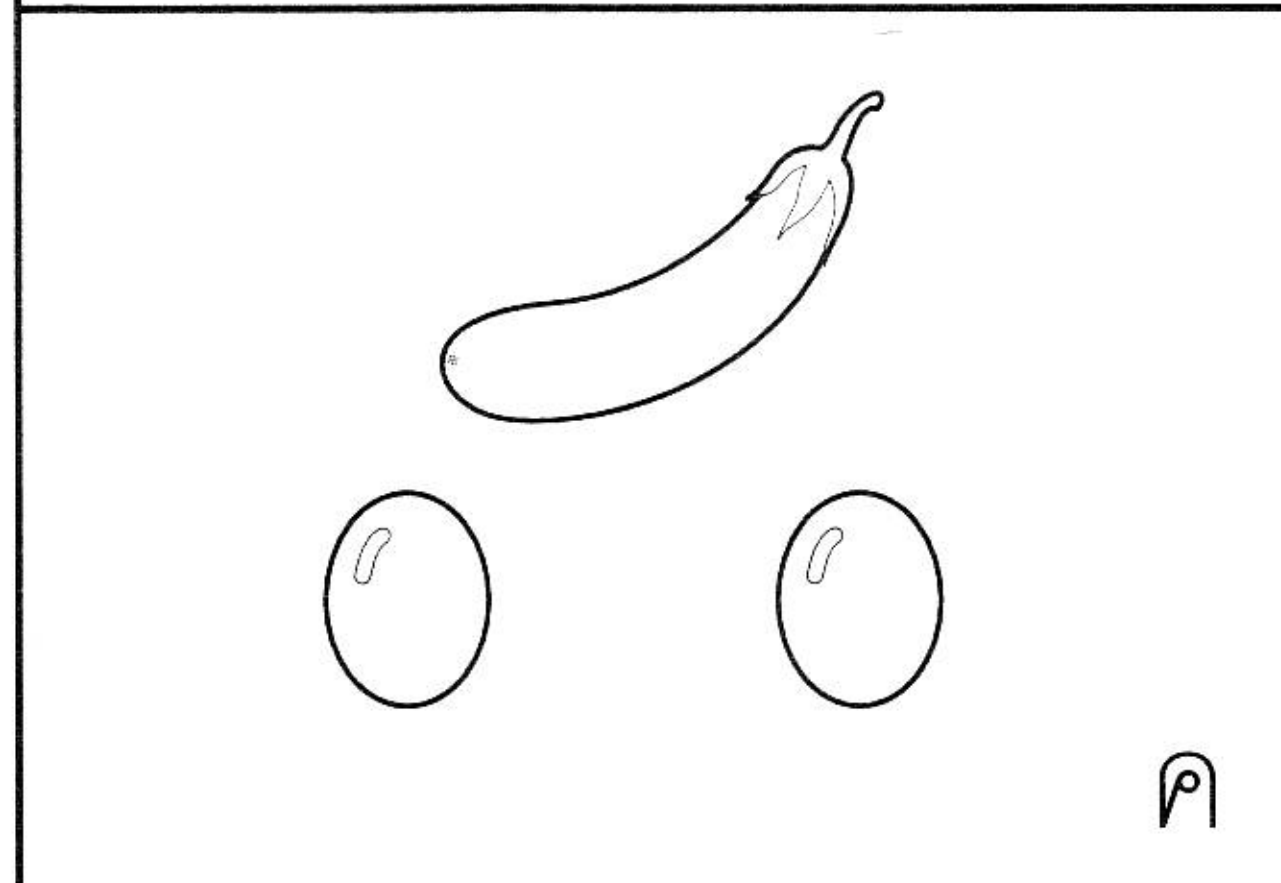
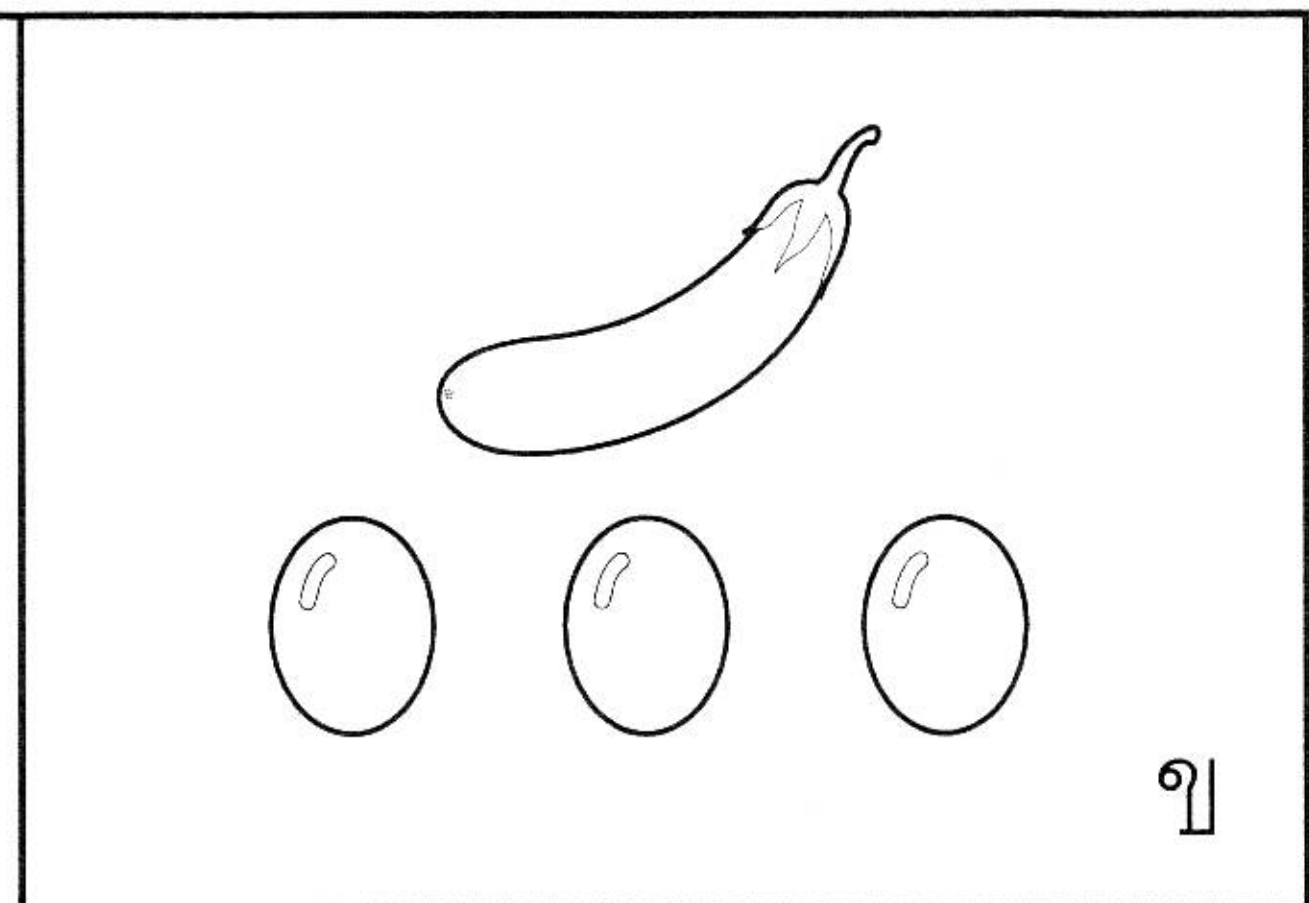
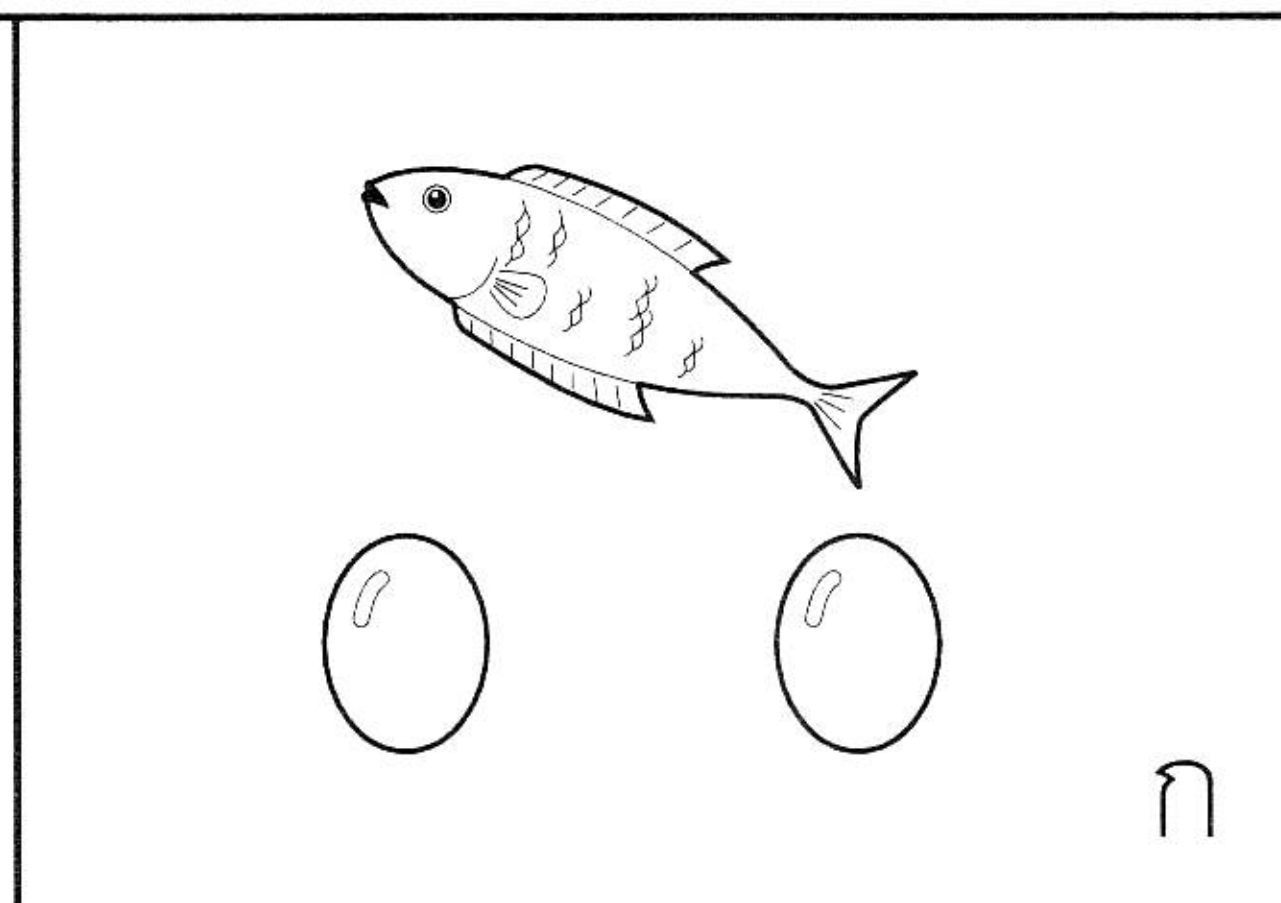

ก

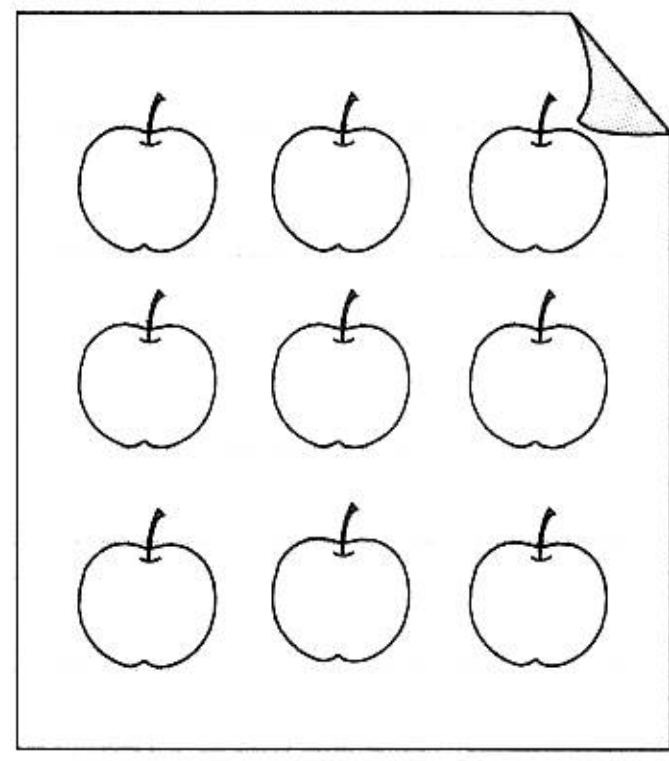
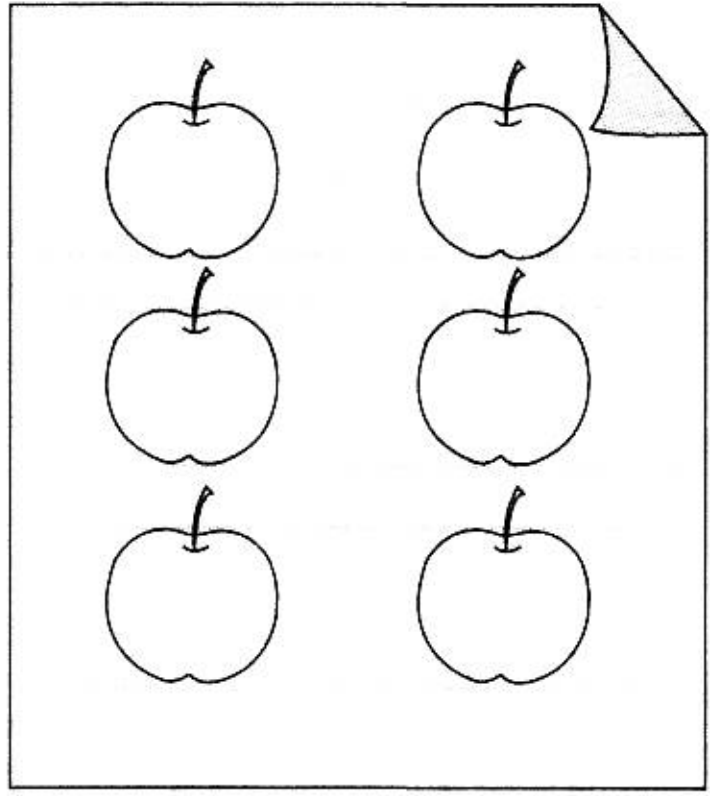

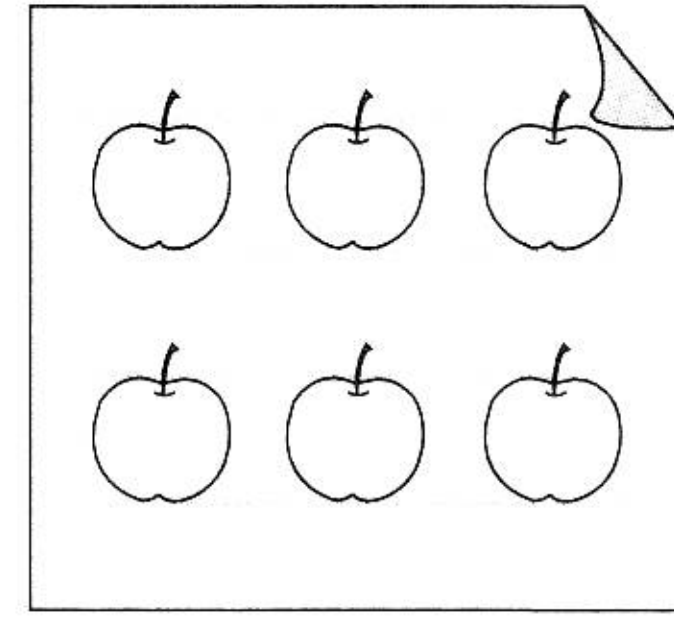
ข

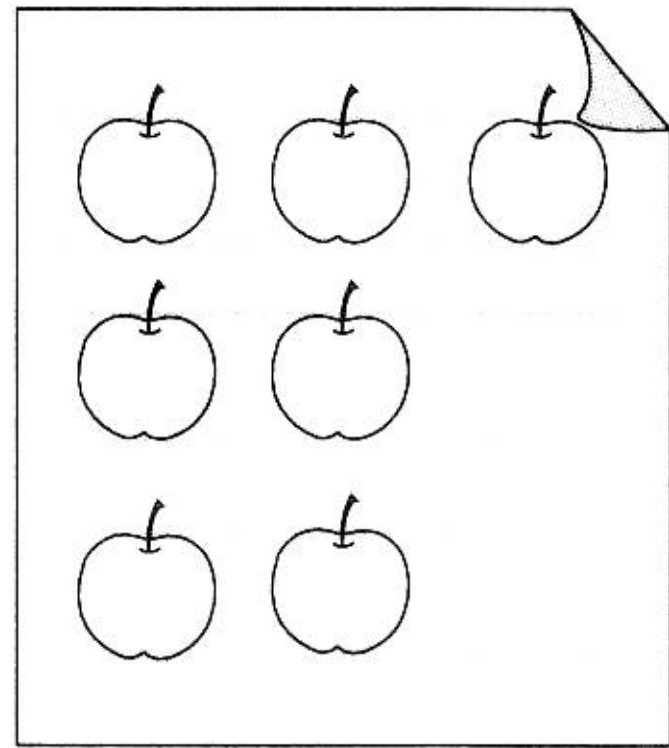

ค

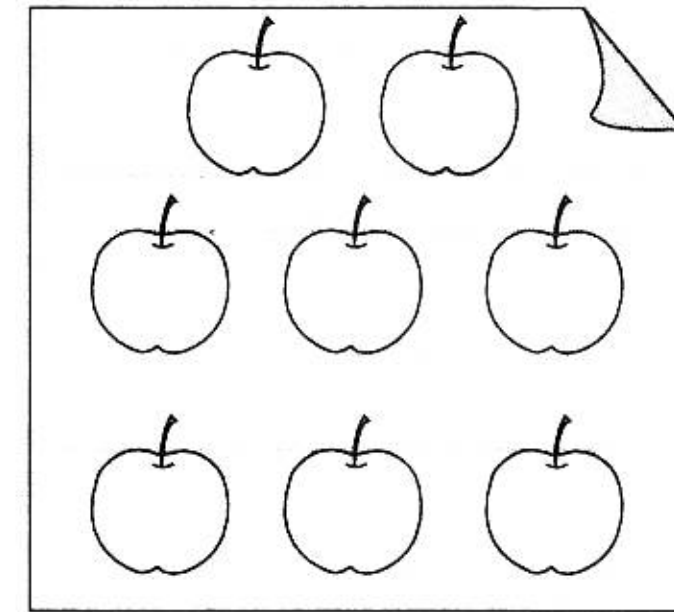

ง

20 มีโดนัท 4 ชิ้น คูกี้ 3 ชิ้น  
 เอาไปกินอย่างละ 1 ชิ้น  
 จะเหลือกี่ชิ้น

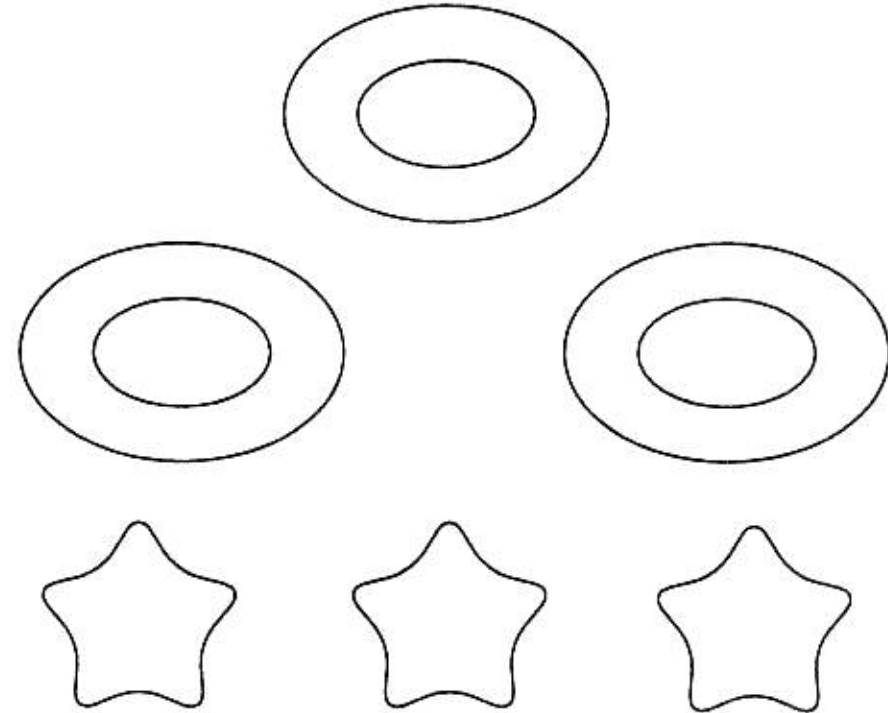
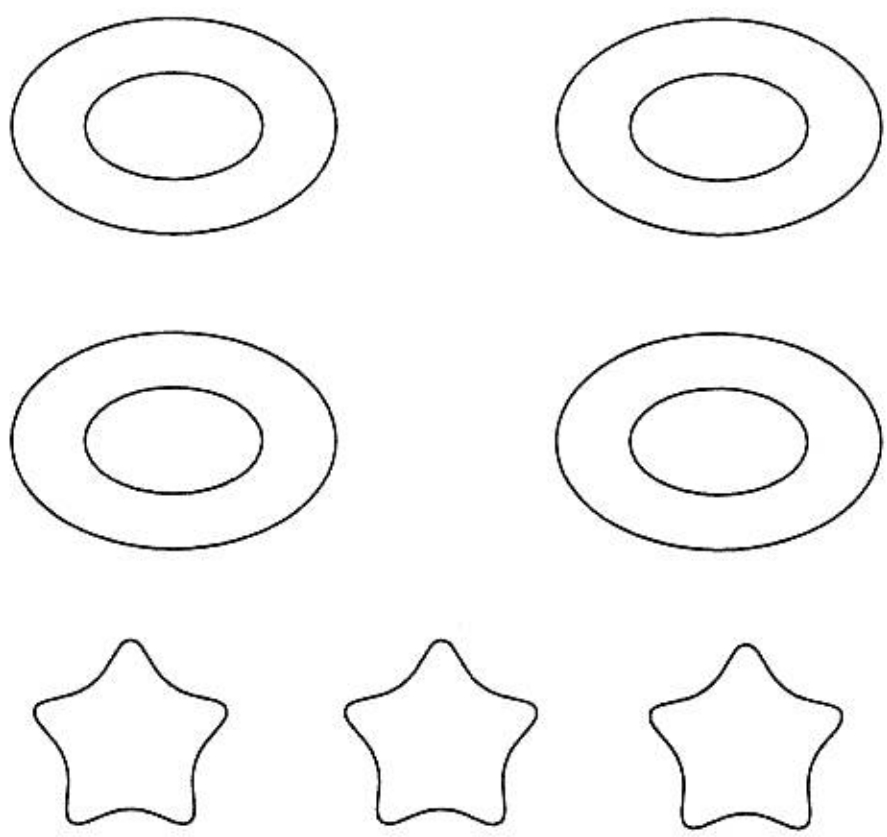

ก

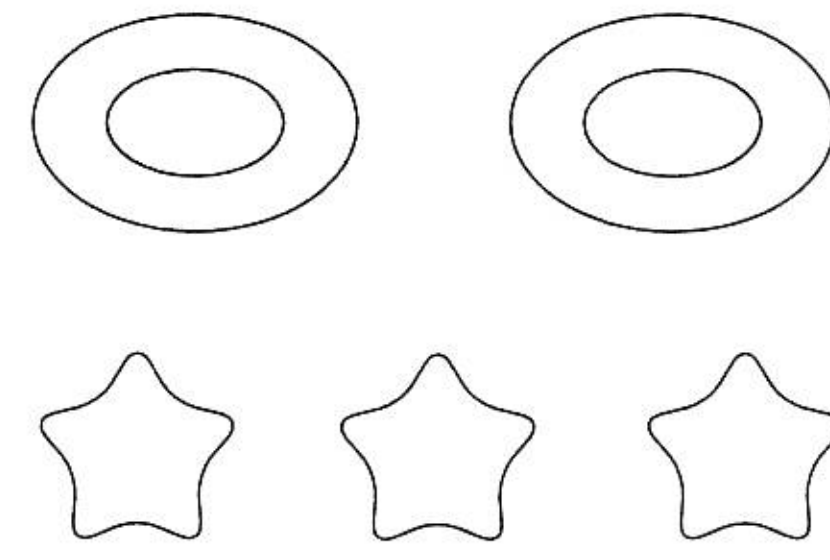

ข

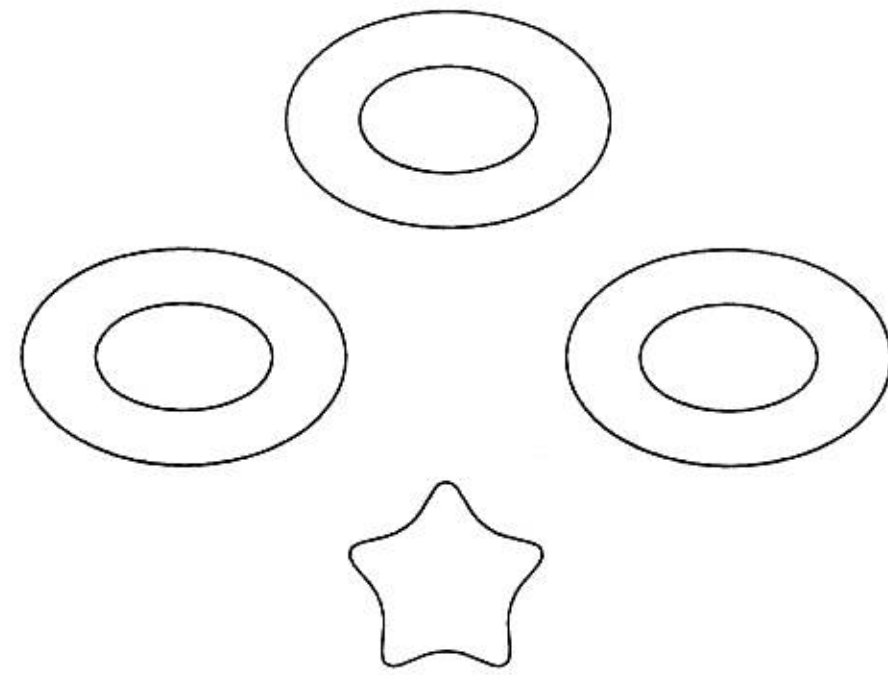

ค

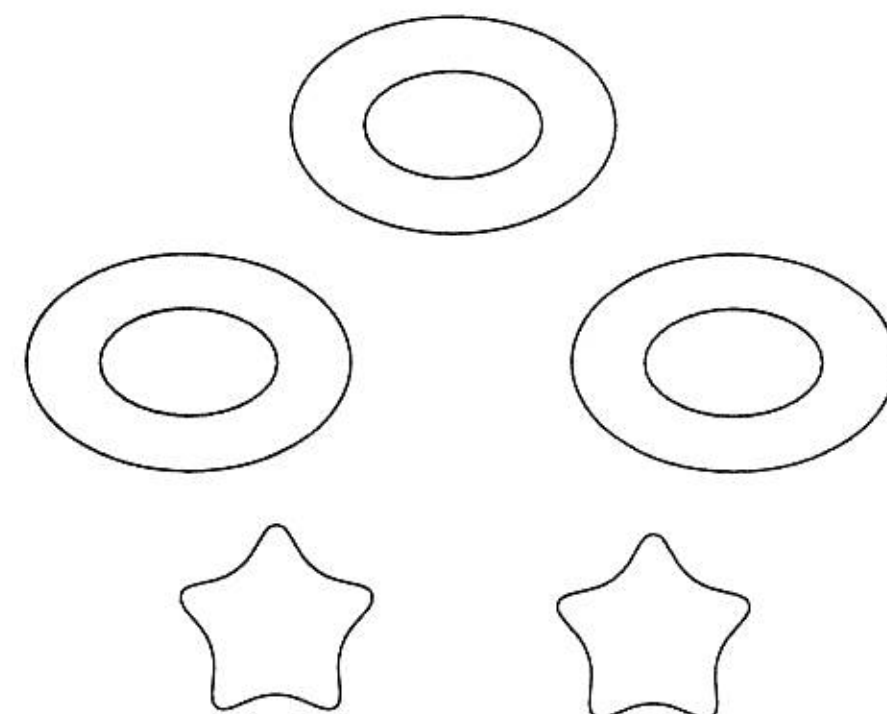

ง

21 มีมังคุด 5 ผลกับมะพร้าว  
 อีก 2 ลูก กินมังคุดไป 3 ผล  
 แล้วซื้อมะพร้าวมาเพิ่ม 1 ลูก  
 จะมีผลไม้แต่ละชนิดเหลือ  
 ไว้กินเท่าไร

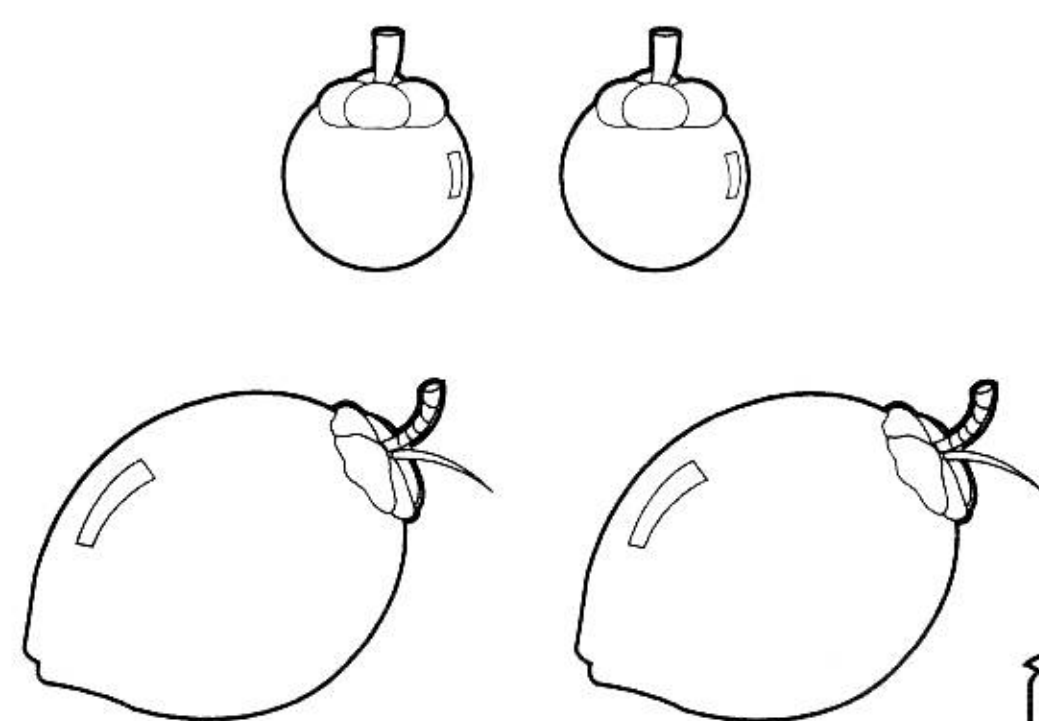
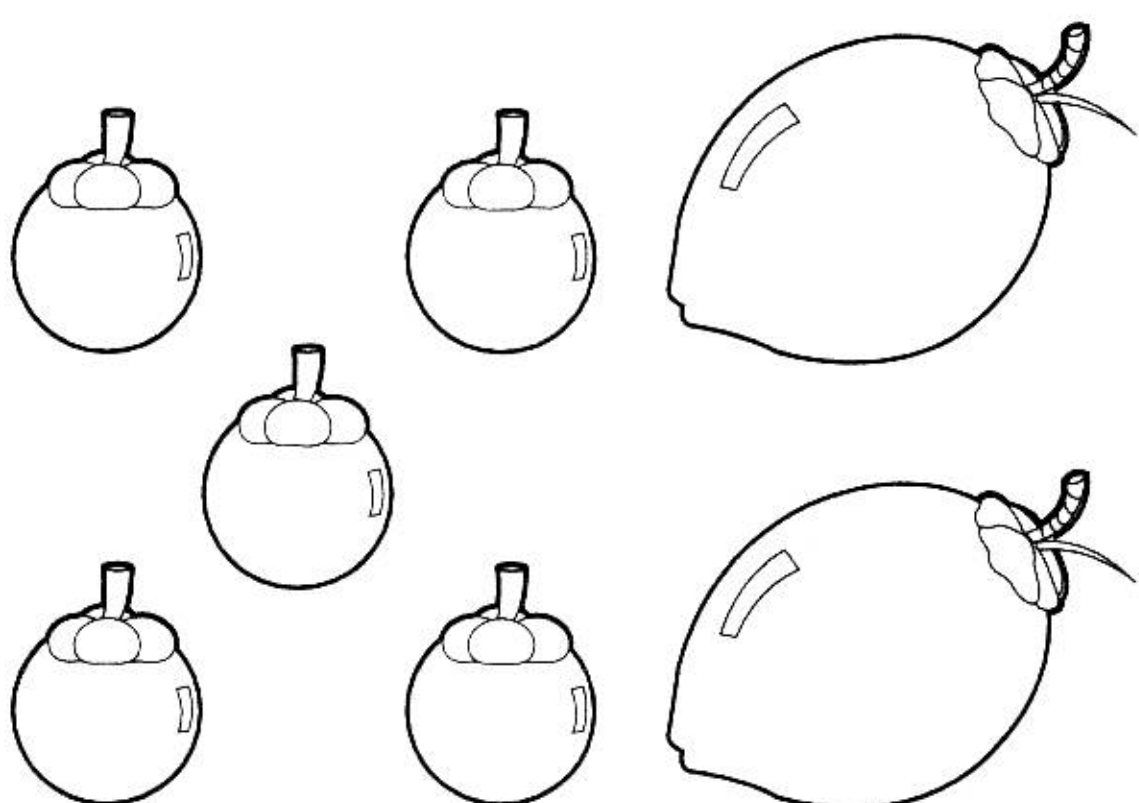

ก

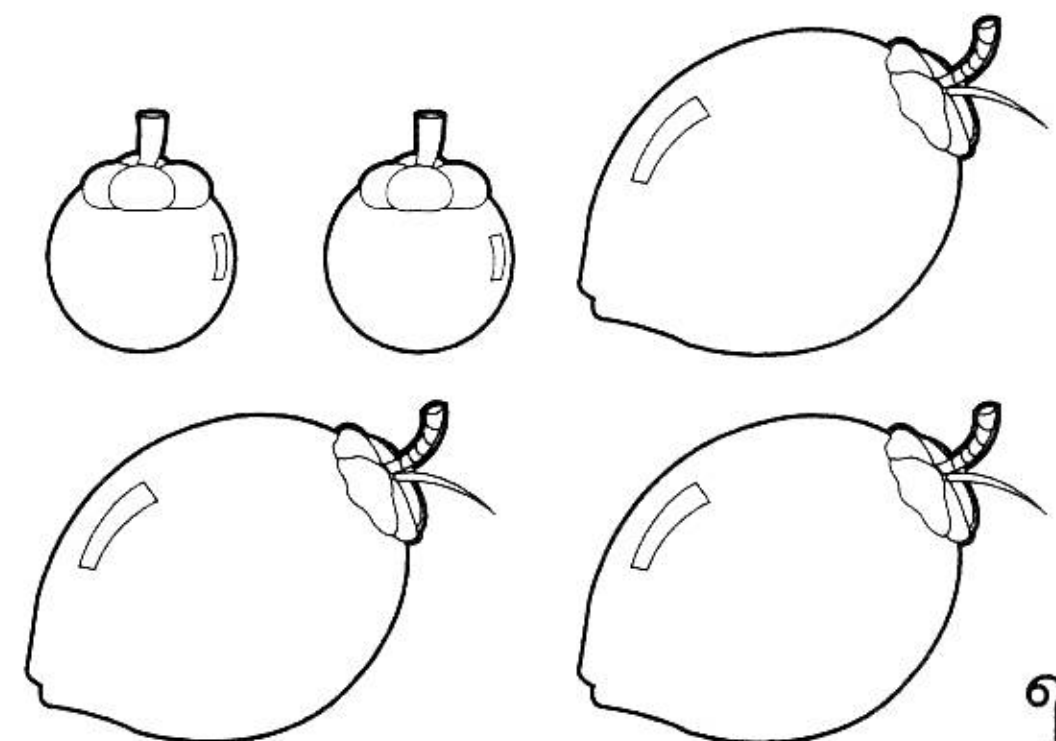

ข

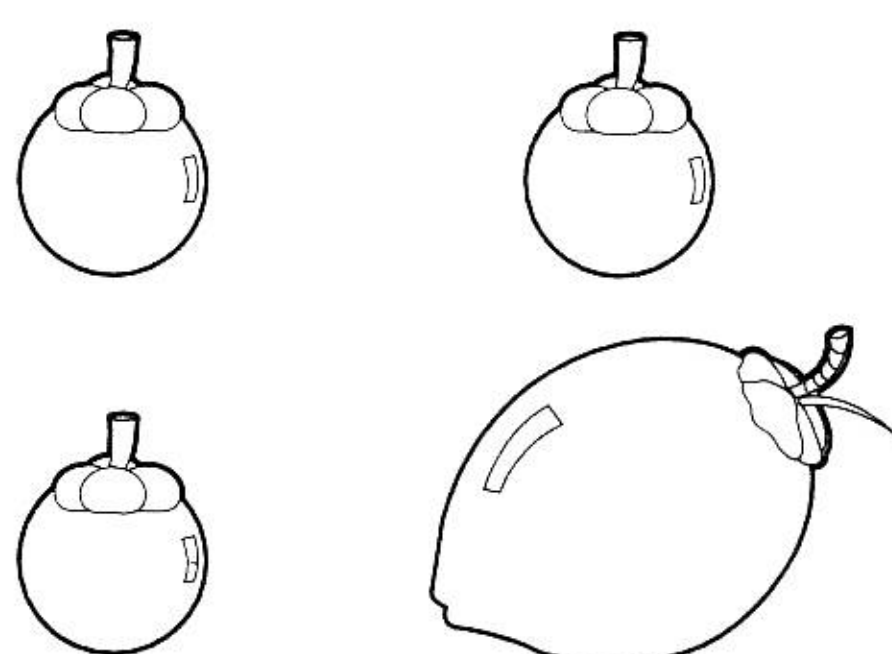

ค

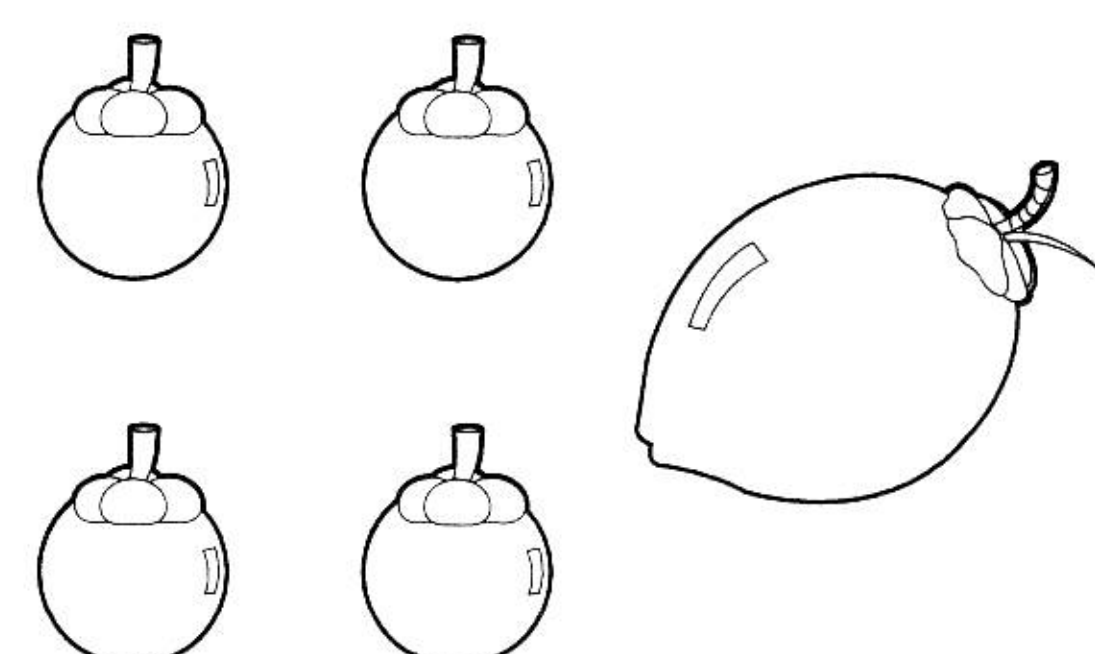

ง

22

มีเรือจอดเทียบท่าอยู่ 7 ลำ  
ต่อมาวิ่งออกทะเลไป 3 ลำ  
จะมีเรือเหลือกี่ลำ

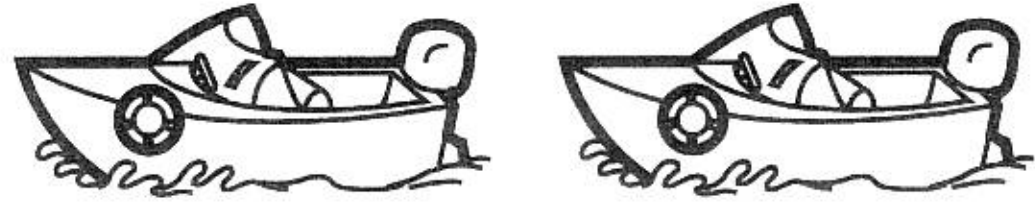
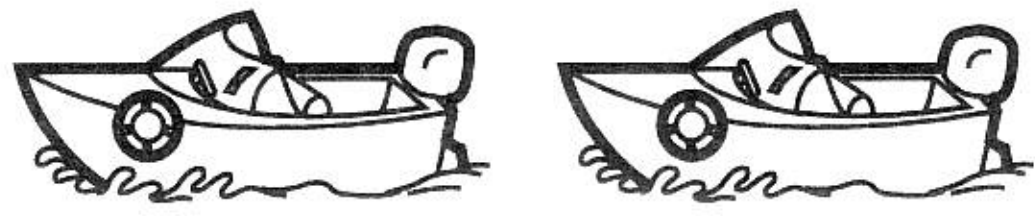
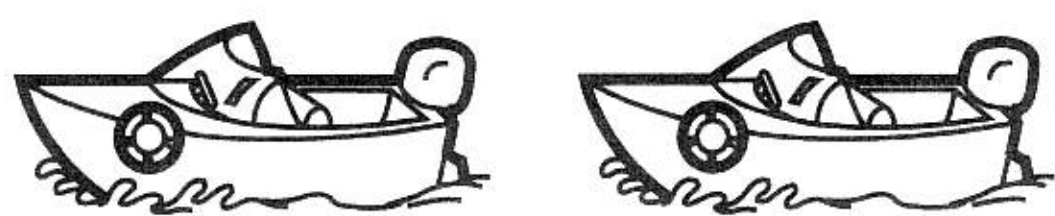
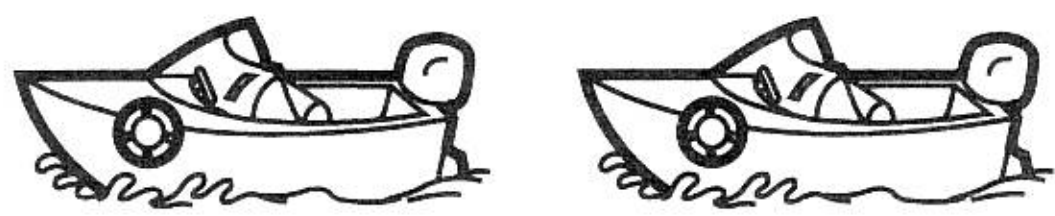
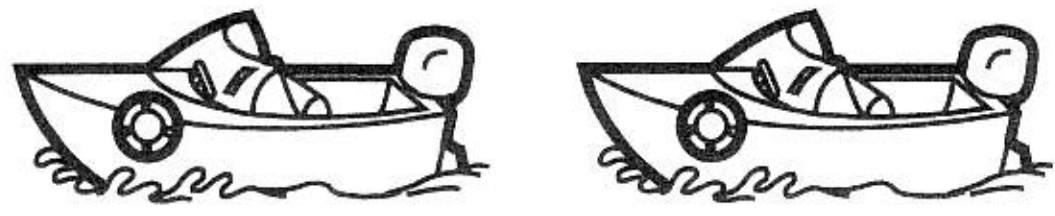

ก

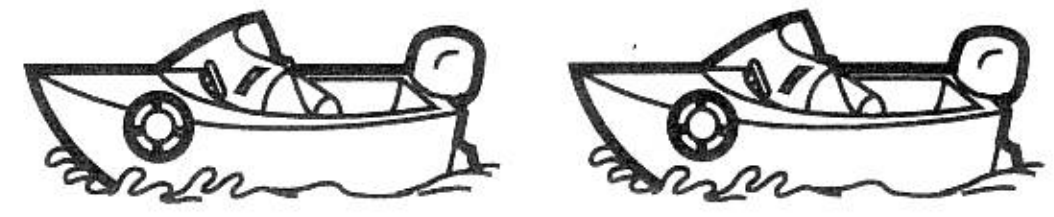

ข

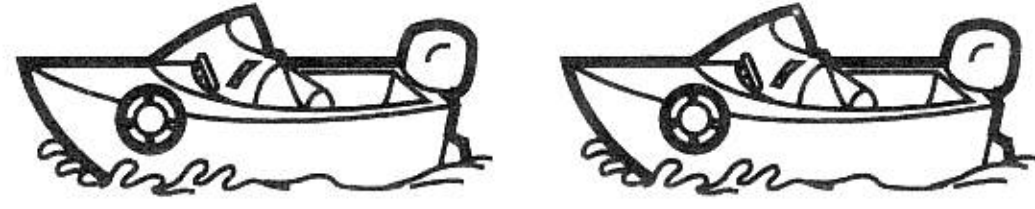

ค

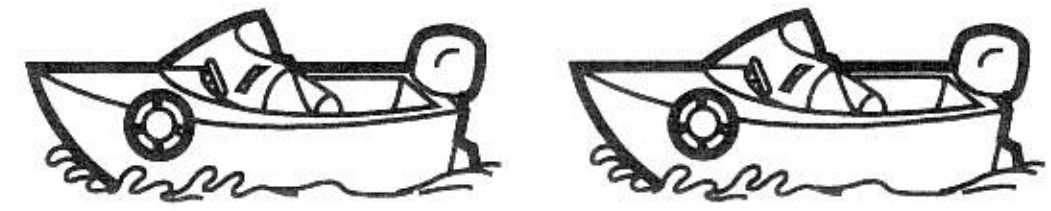
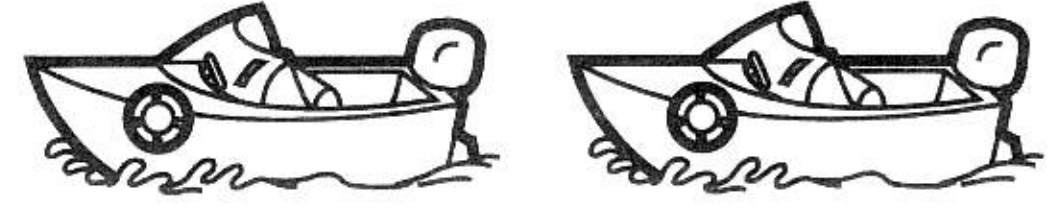

ง

23

มีตุ๊กตาทิมะอยู่ 6 ตัว  
ต่อมาละลายไป 3 ตัว  
ต้องปั้นเพิ่มกี่ตัวจึงจะ  
เท่าเดิม

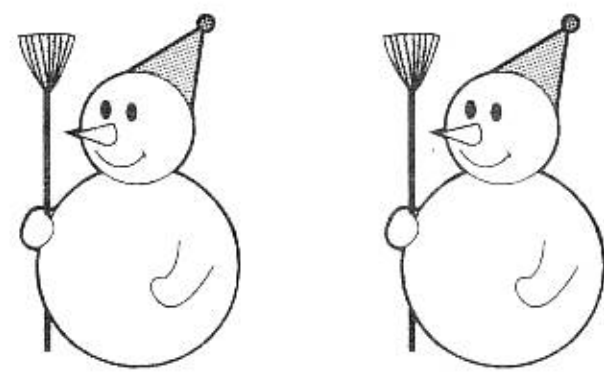

ก

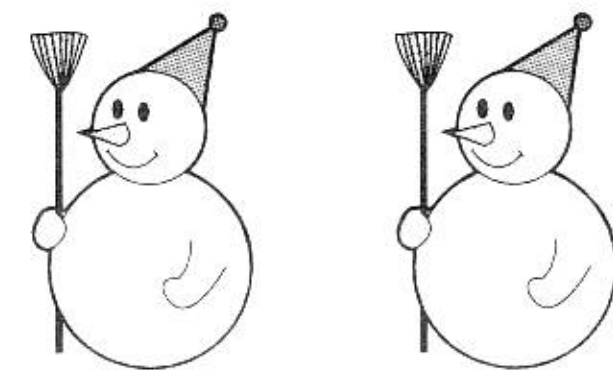

ข



ค

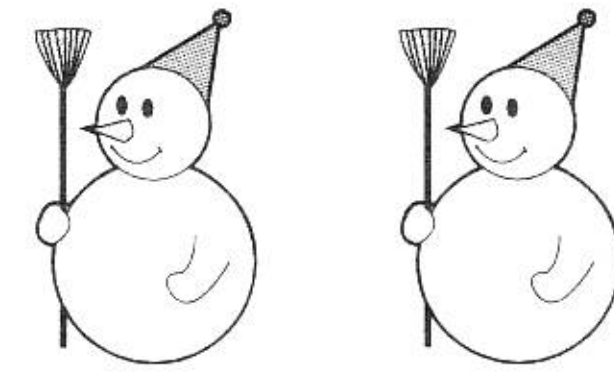
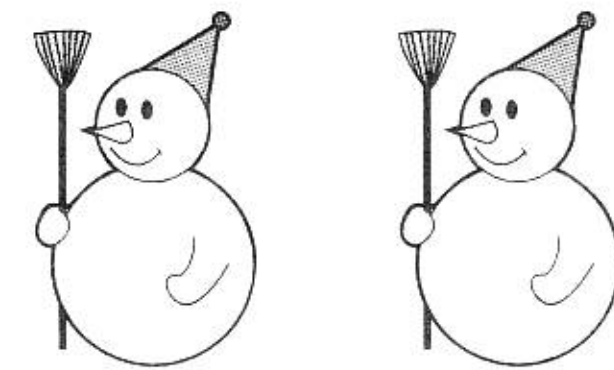

ง

24

มีกุ้ง 5 ตัว มีปู 3 ตัว  
ต้องซื้อปูมาเพิ่มอีกกี่ตัว  
จึงจะมีจำนวนเท่ากัน

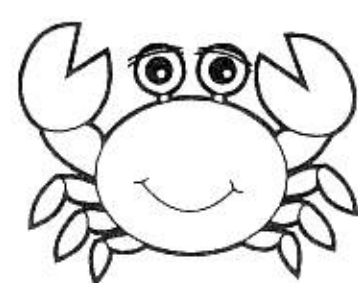
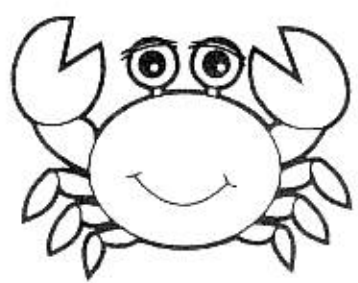
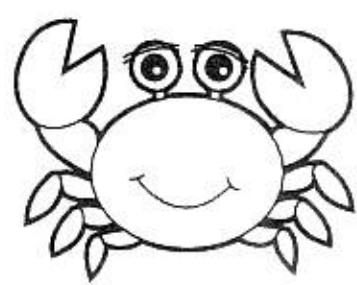
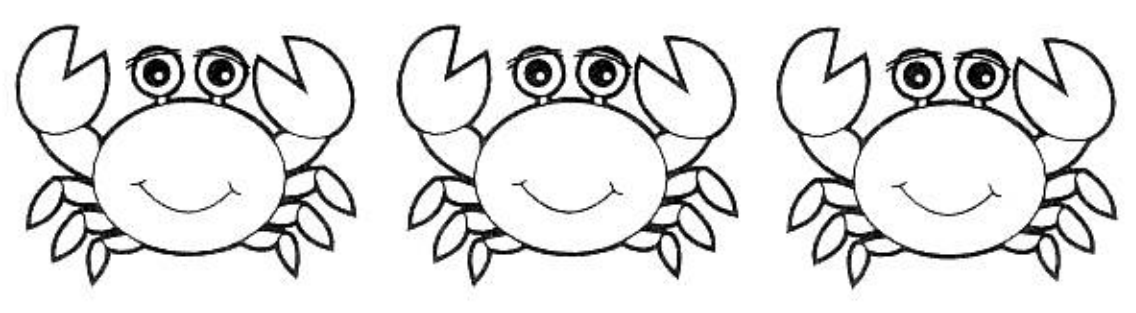
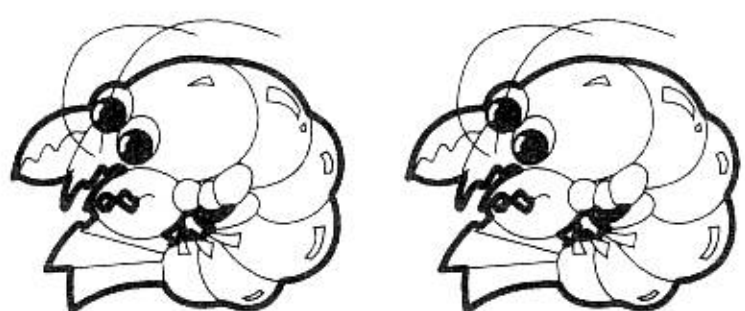

ก

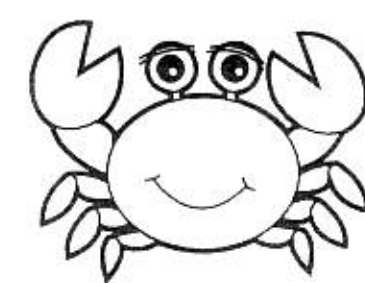
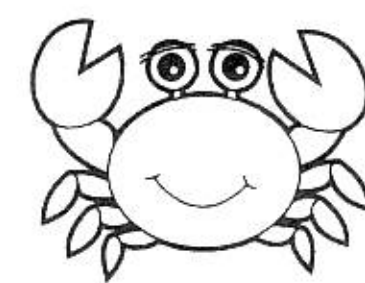

ข

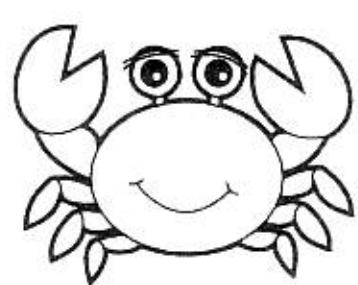
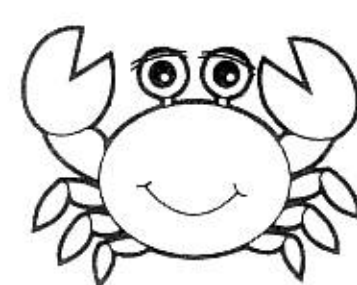
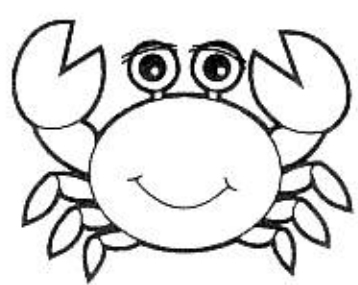

ค

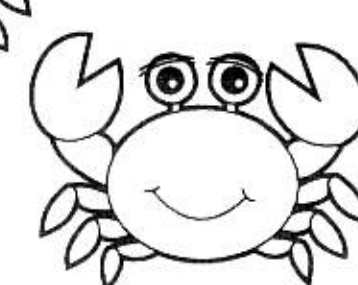
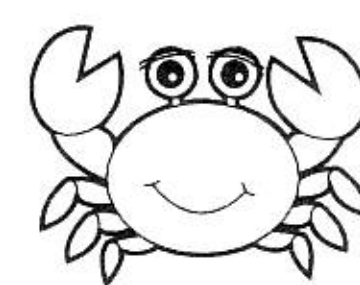
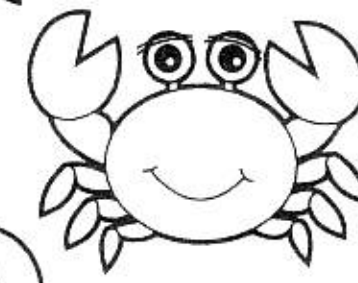
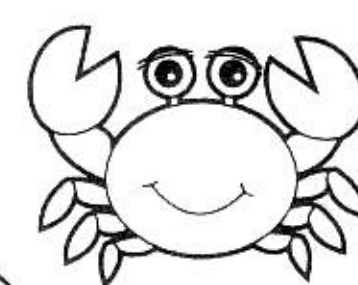
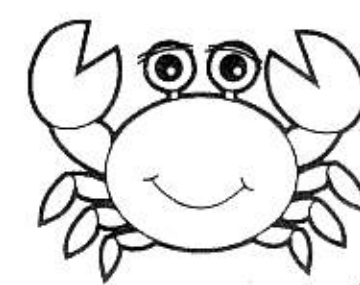

ง

25 มีนกเกาะอยู่บนกิ่งไม้ 4 ตัว  
บินออกไป 2 ตัวจะเหลือนกบนกิ่งไม้กี่ตัว

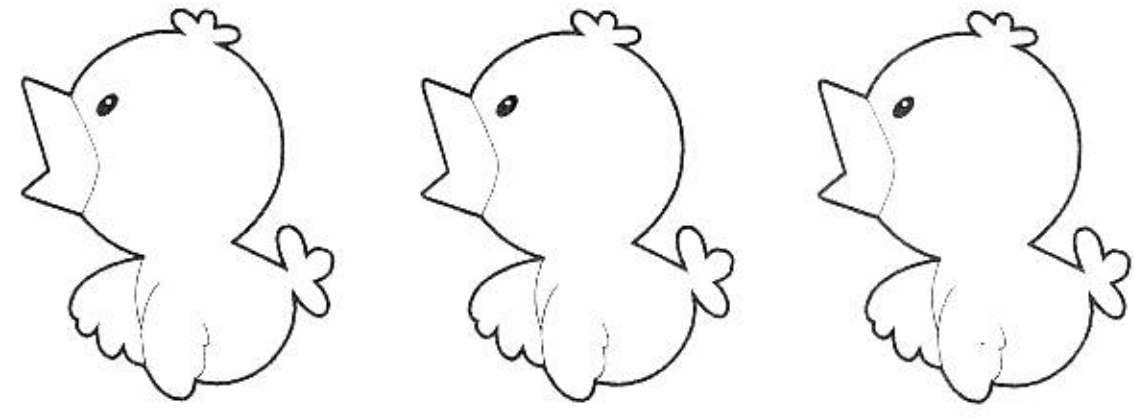
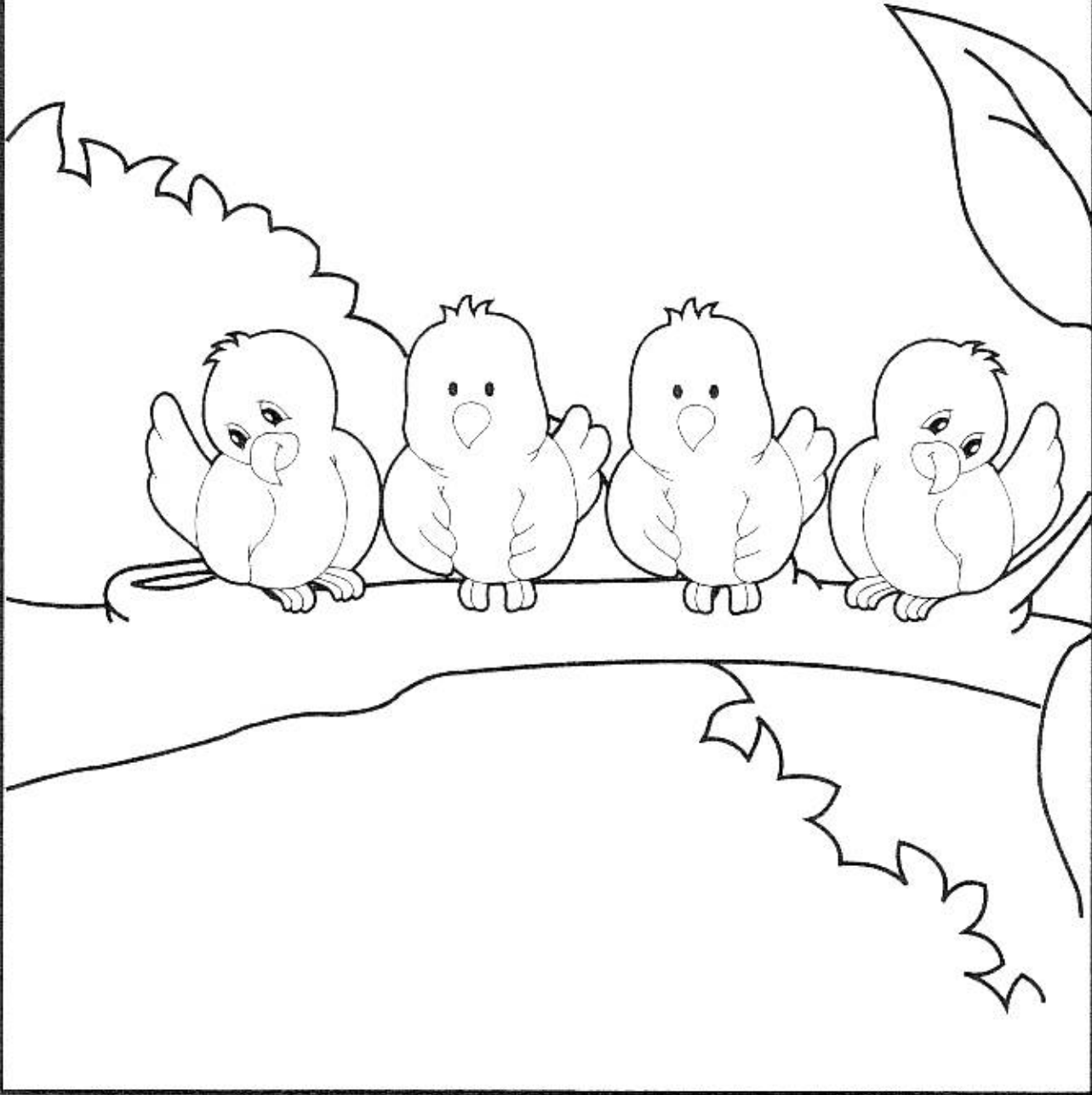

ก



ข

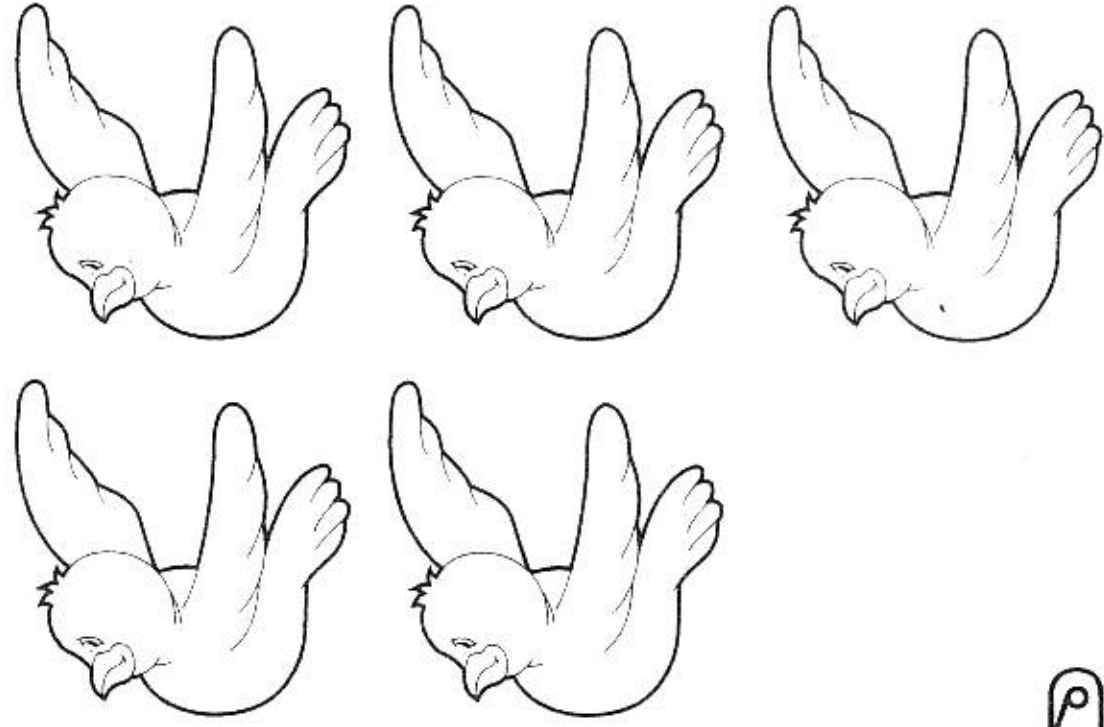

ค

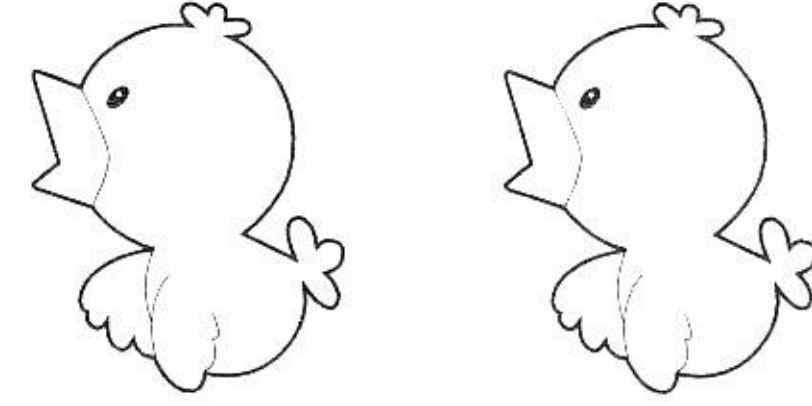

ง

26 แม่มีแอปเปิ้ล 5 ผล  
เสียไป 2 ผล ตอนนี้แม่จะเหลือแอปเปิ้ลกี่ผล

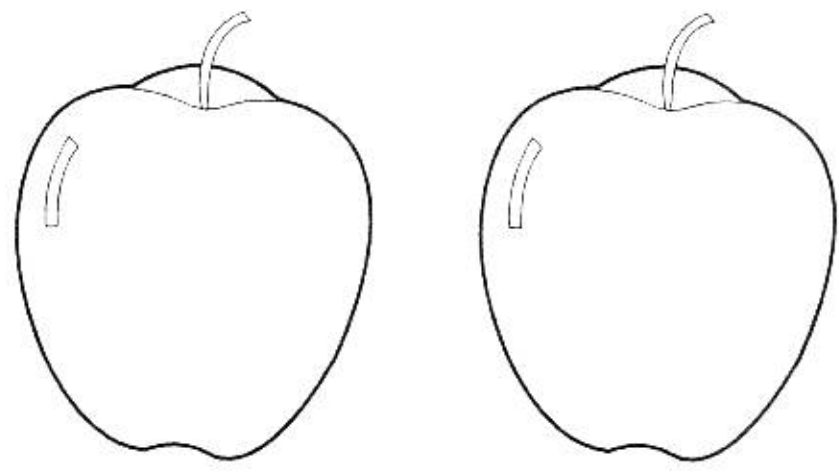
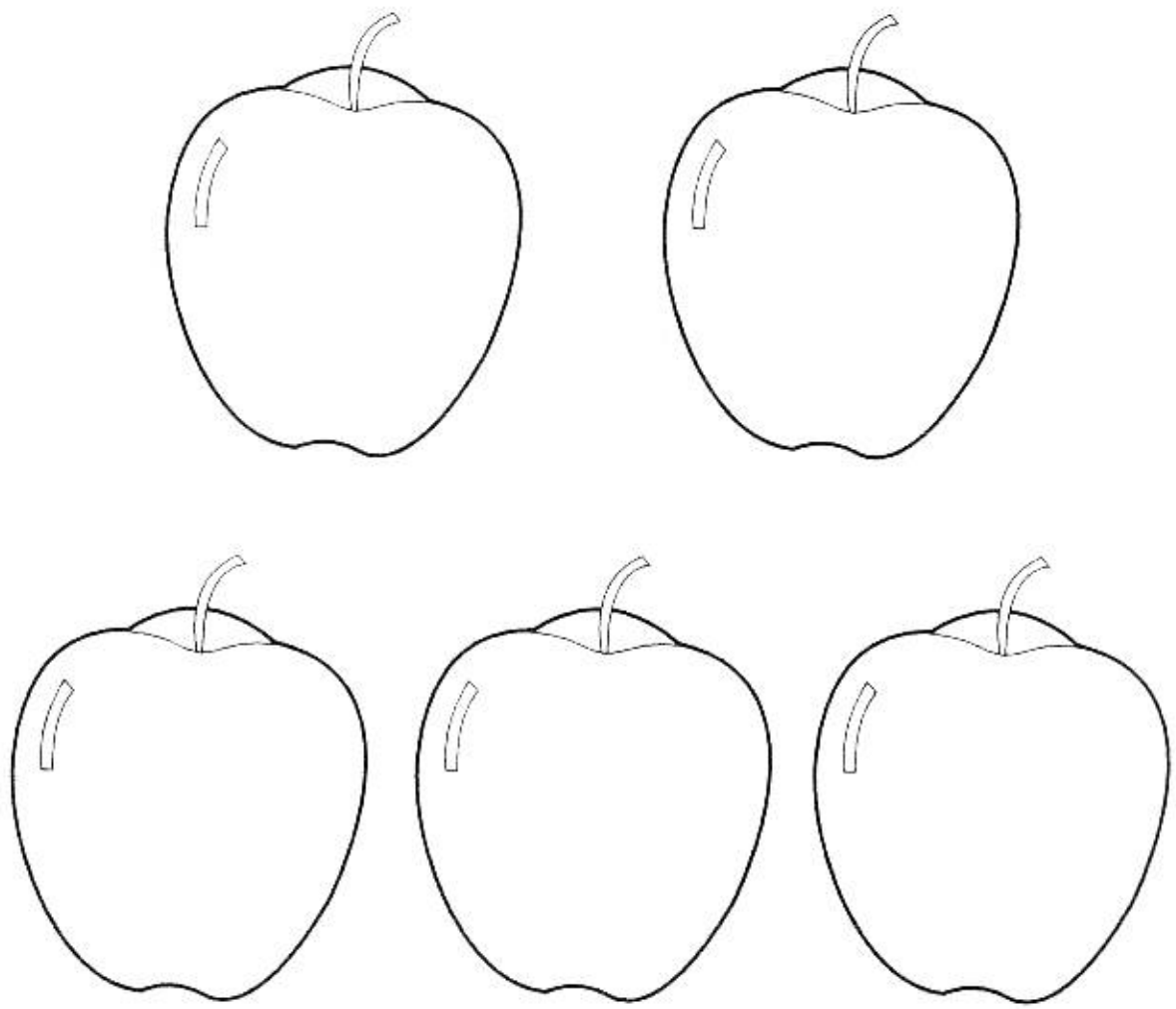

ก

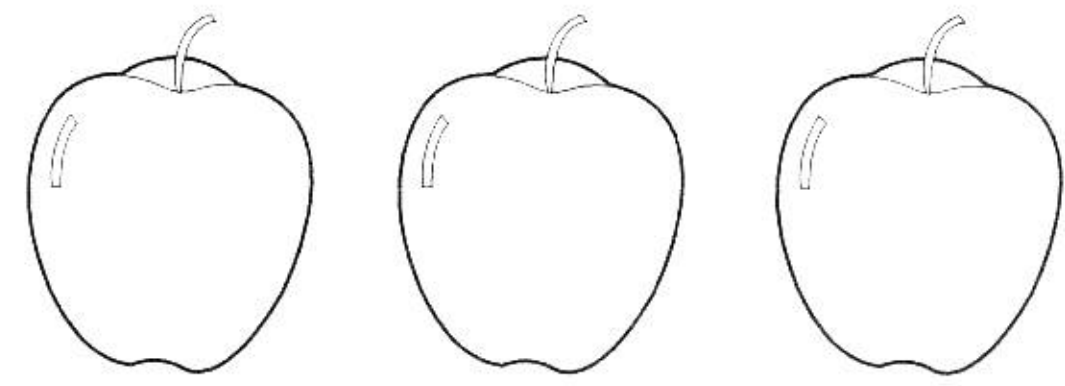

ข

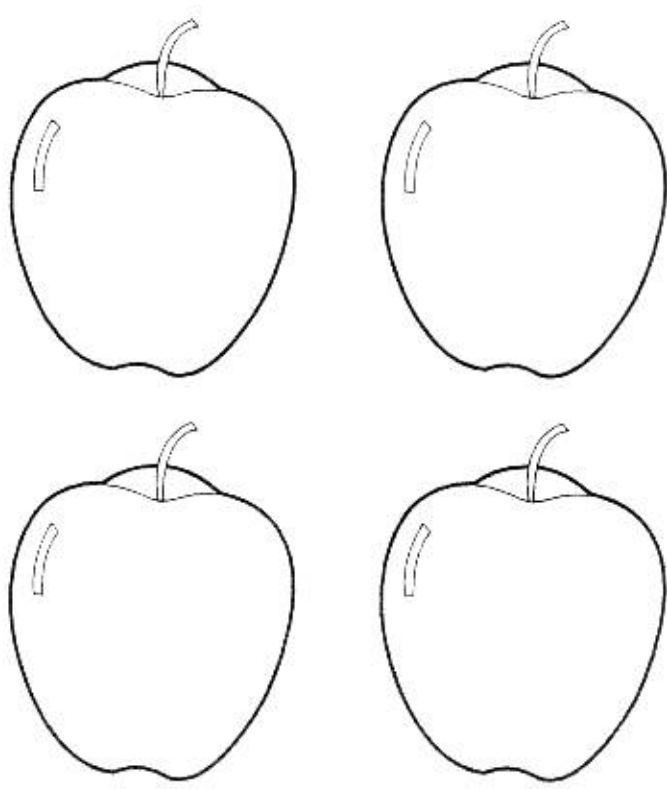

ค

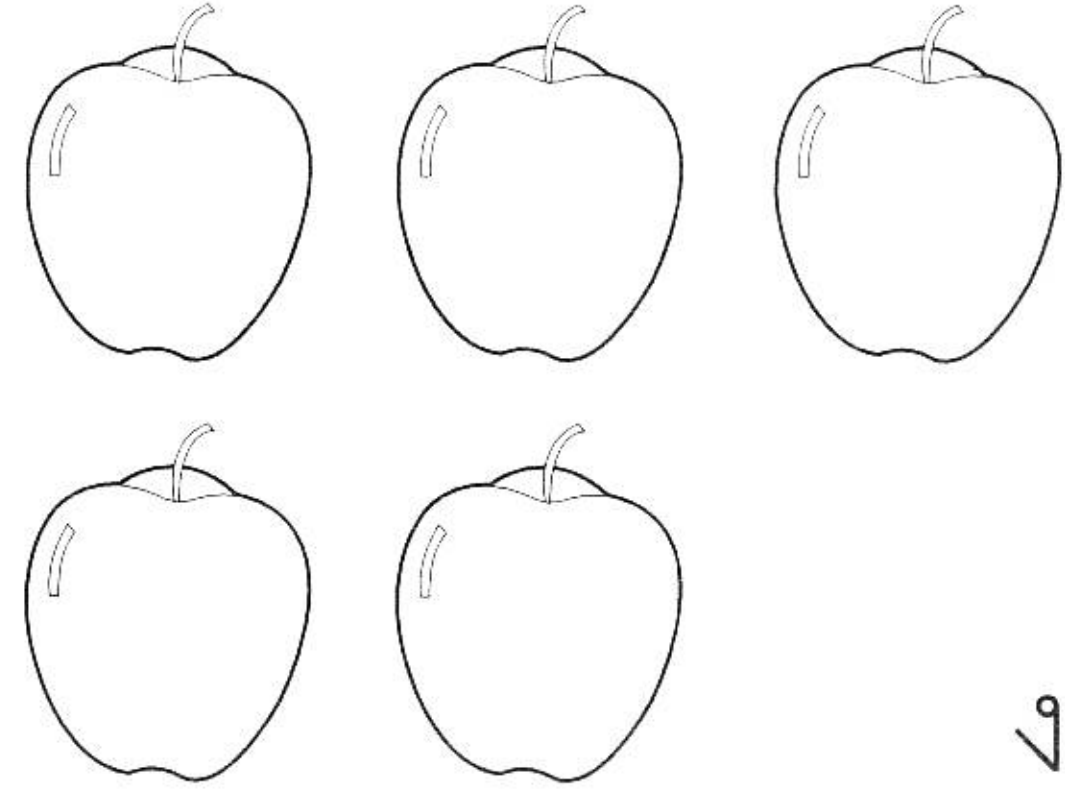

ง

27 พี่มีดินสออยู่ 6 แท่ง  
ซื้อเพิ่มอีก 3 แท่ง  
พี่จะมีดินสออยู่กี่แท่ง

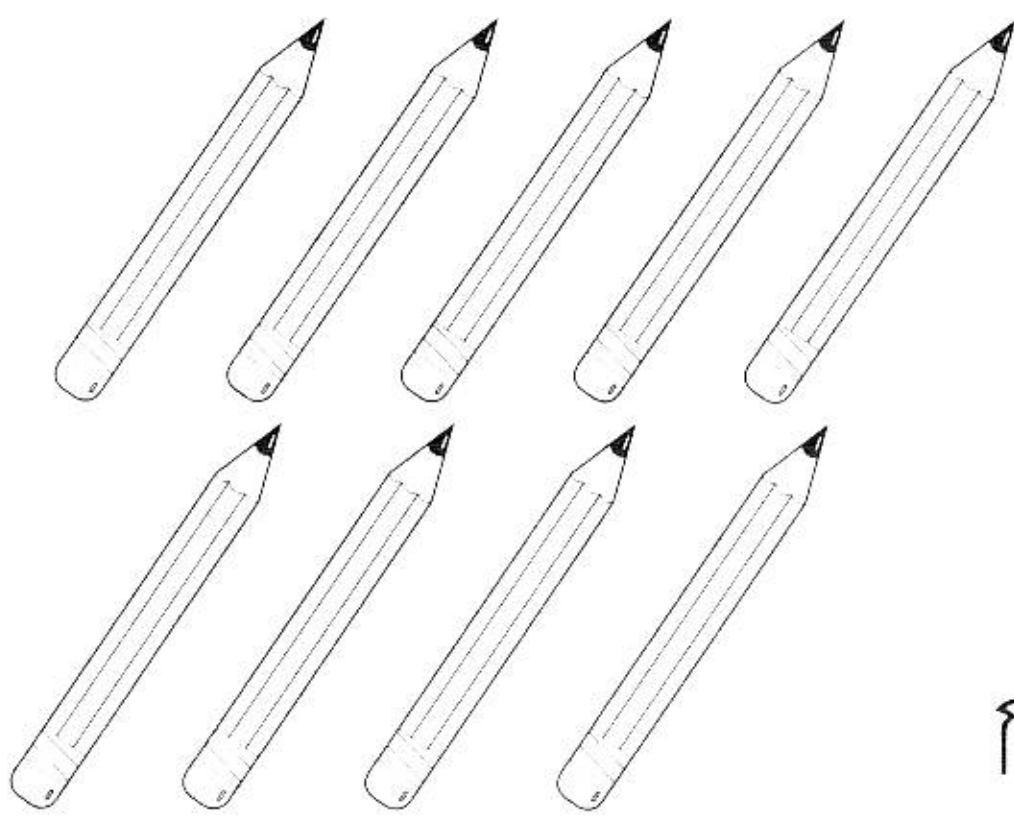
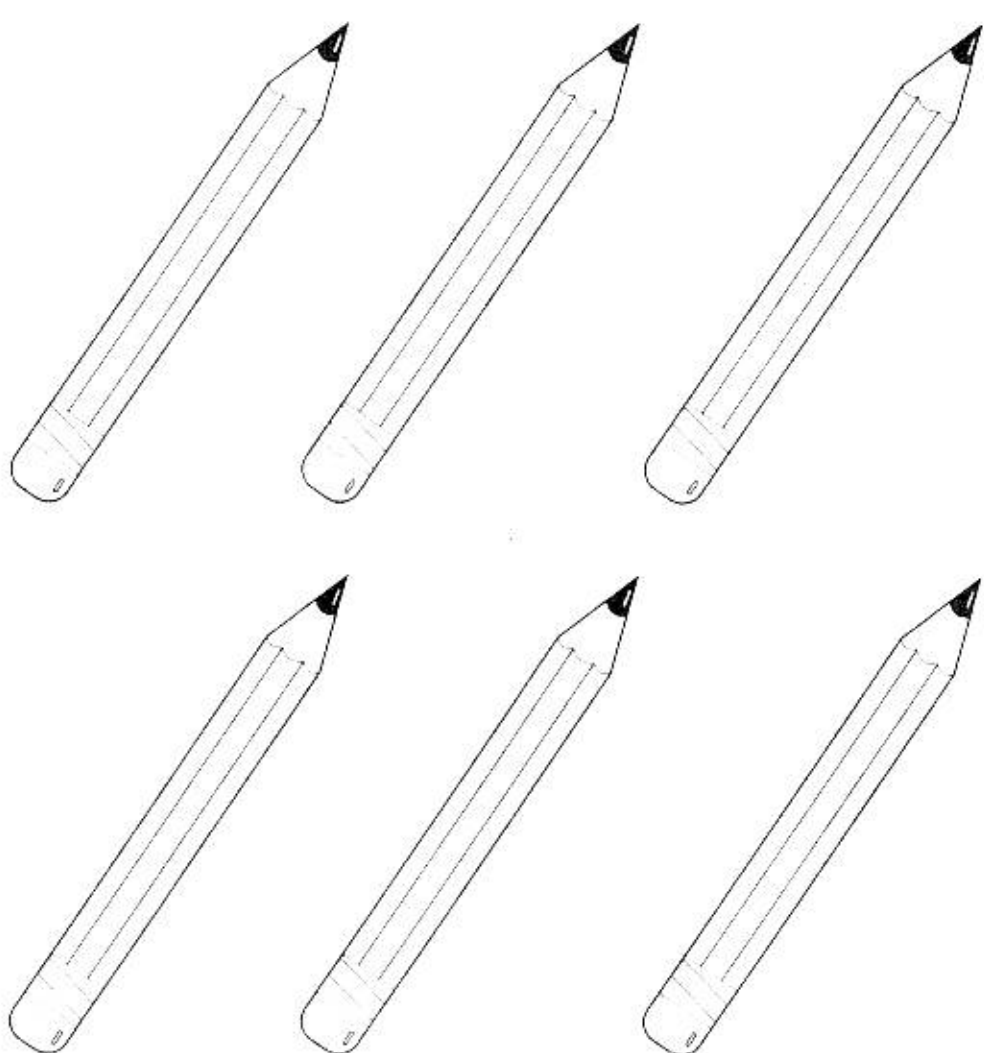

ก

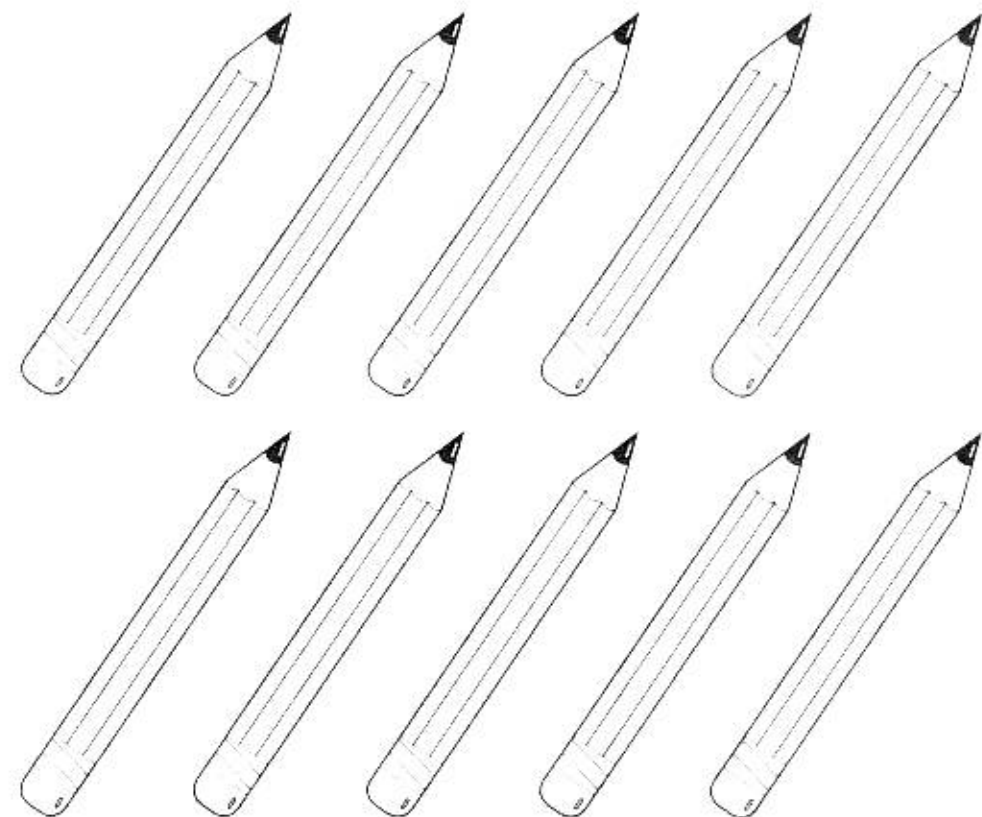

ข

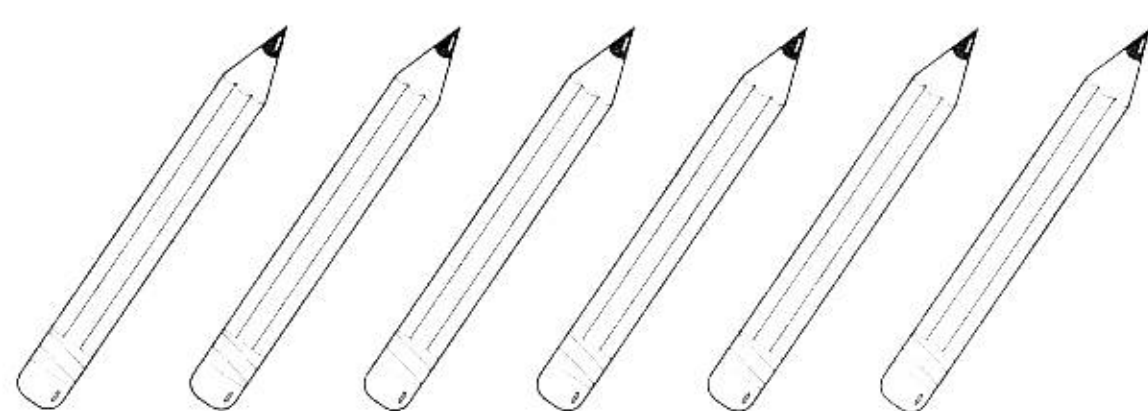

ค

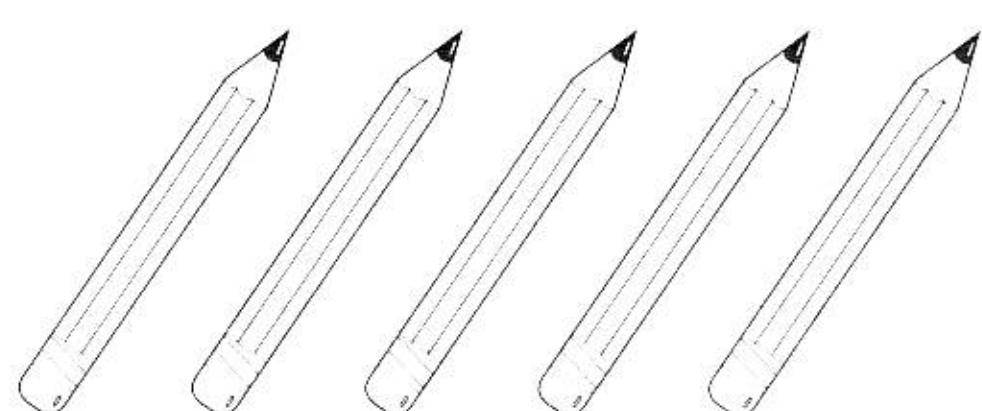

ง

28

ทุเรียนต้นหนึ่งออกลูกมา  
7 ลูกเก็บไปขาย 4 ลูก  
จะเหลือทุเรียนอยู่บนต้น  
กี่ลูก

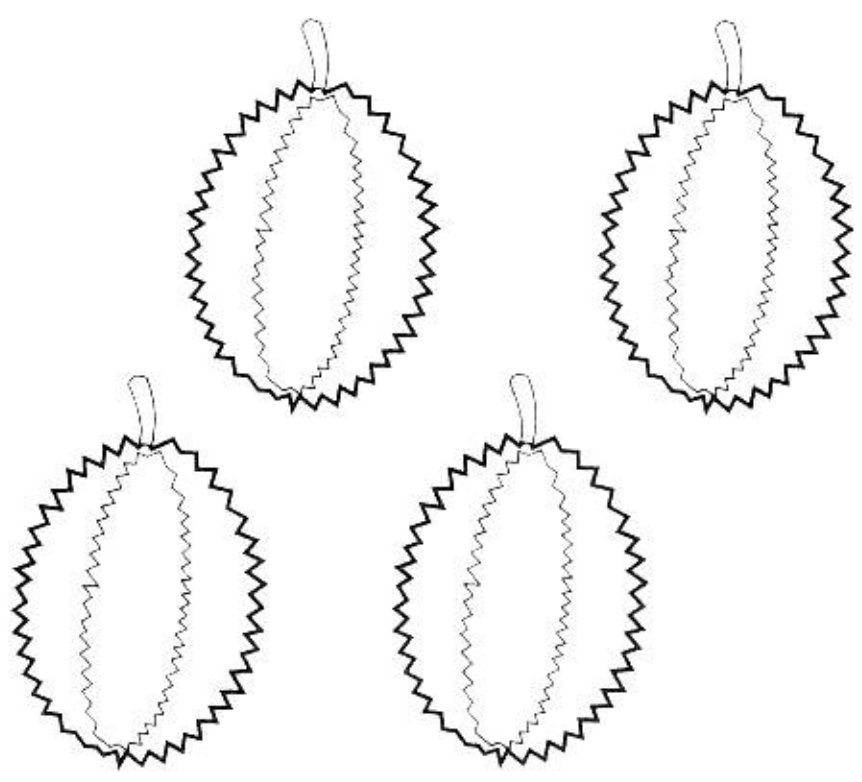
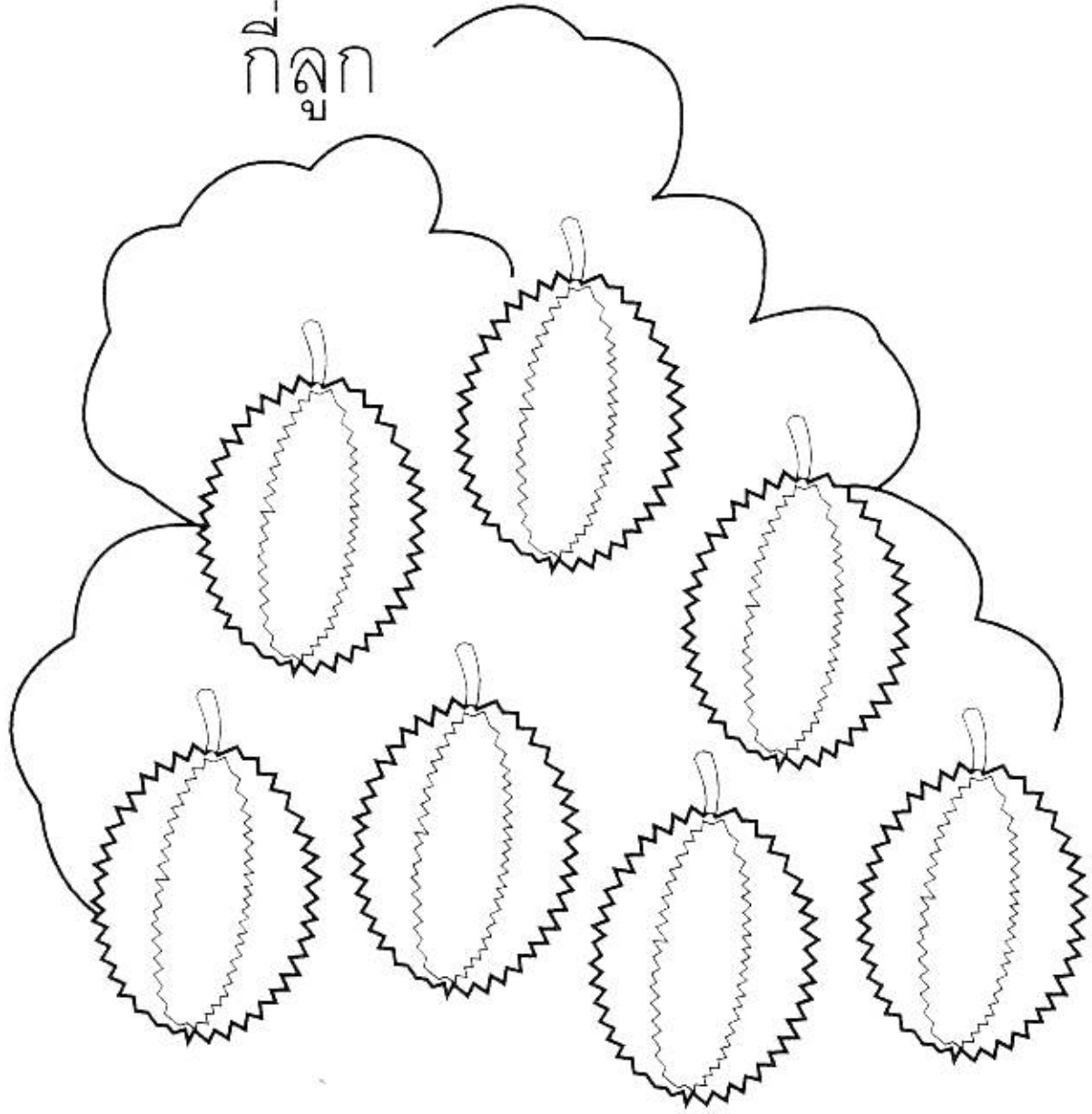

ก

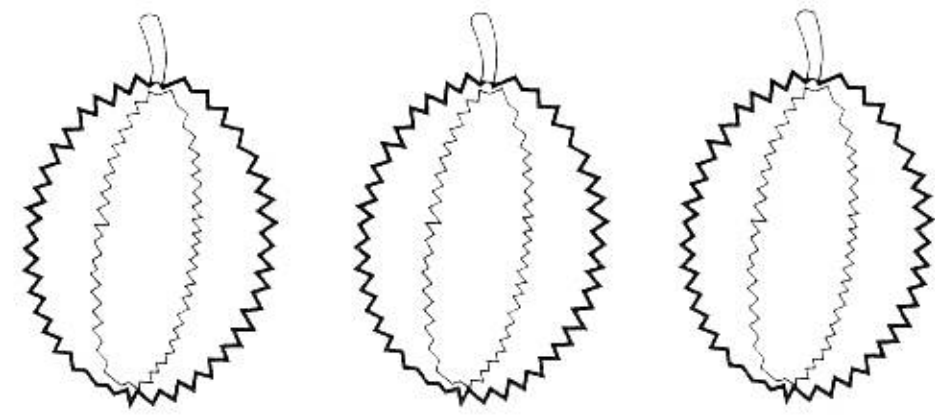

ข

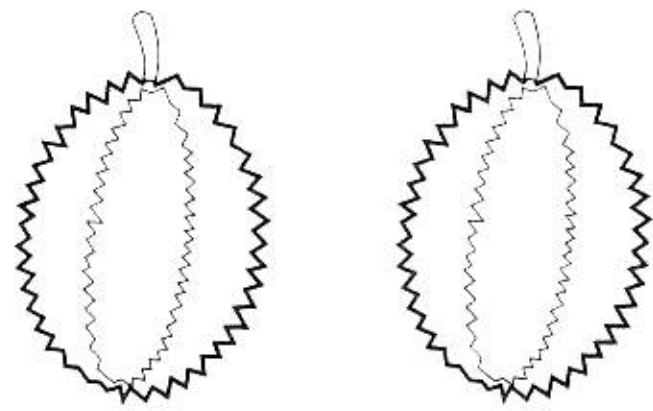

ค

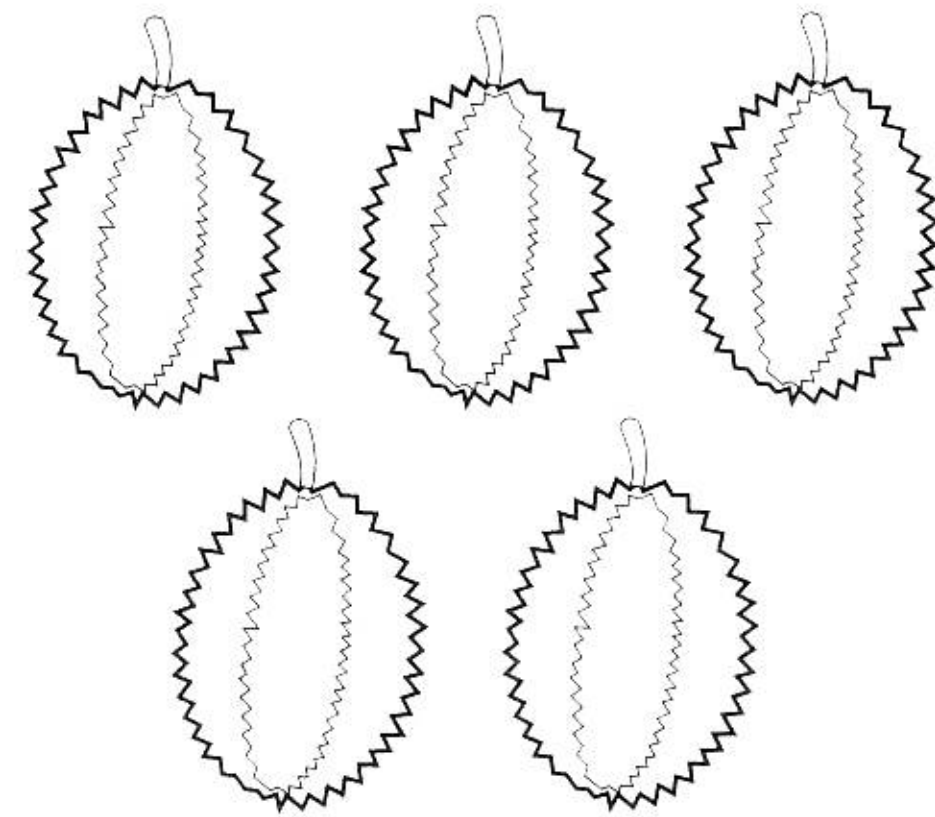

ง

29

พ่อเลี้ยงแกะ 8 ตัว  
ออกลูกมา 3 ตัวตอนนี้  
พ่อมีแกะอยู่ที่ตัว

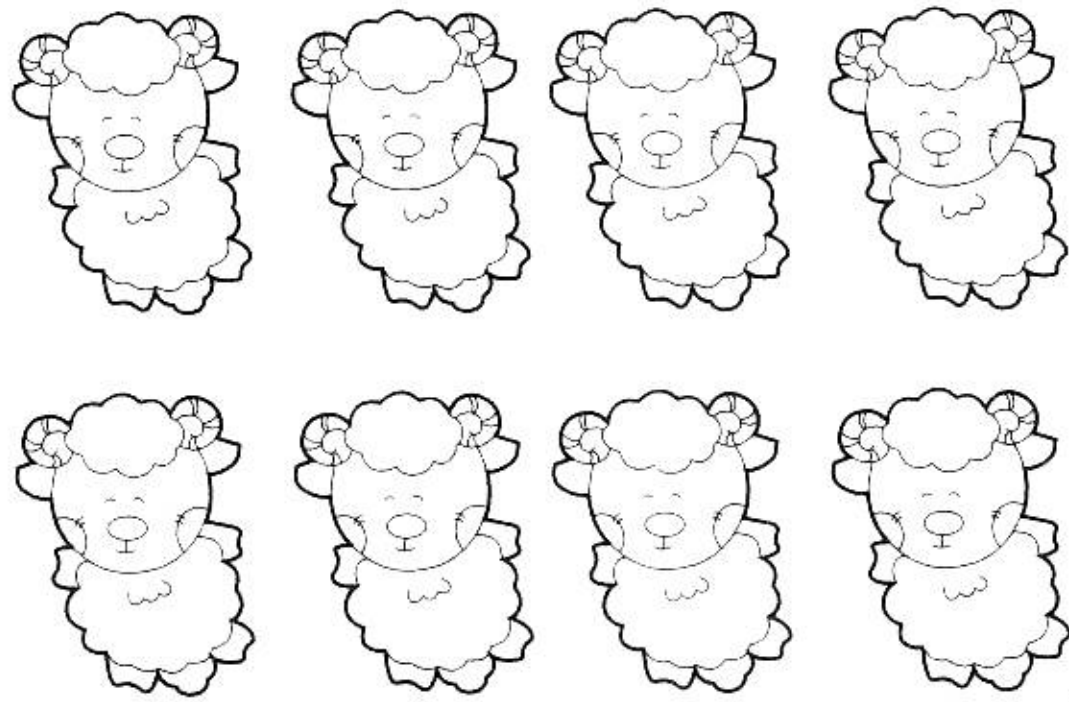
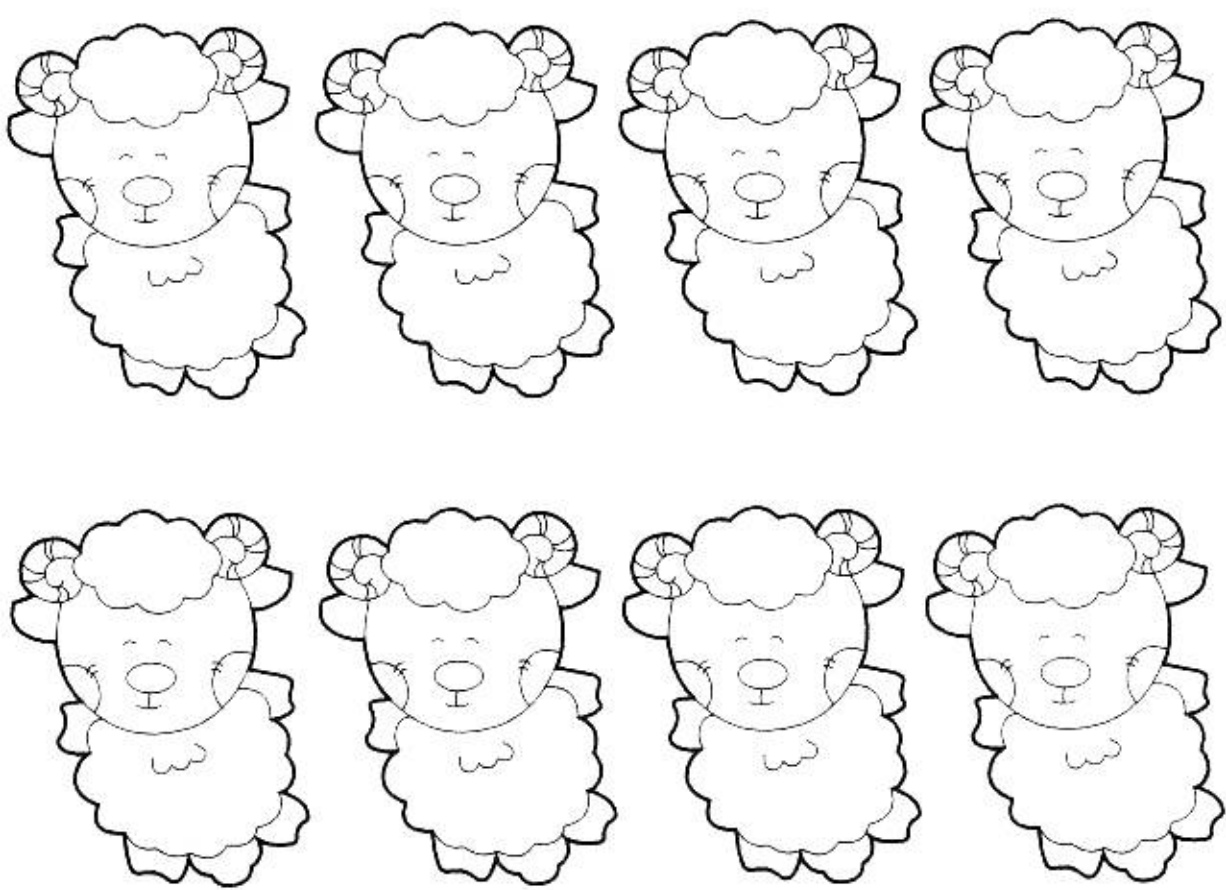

ก

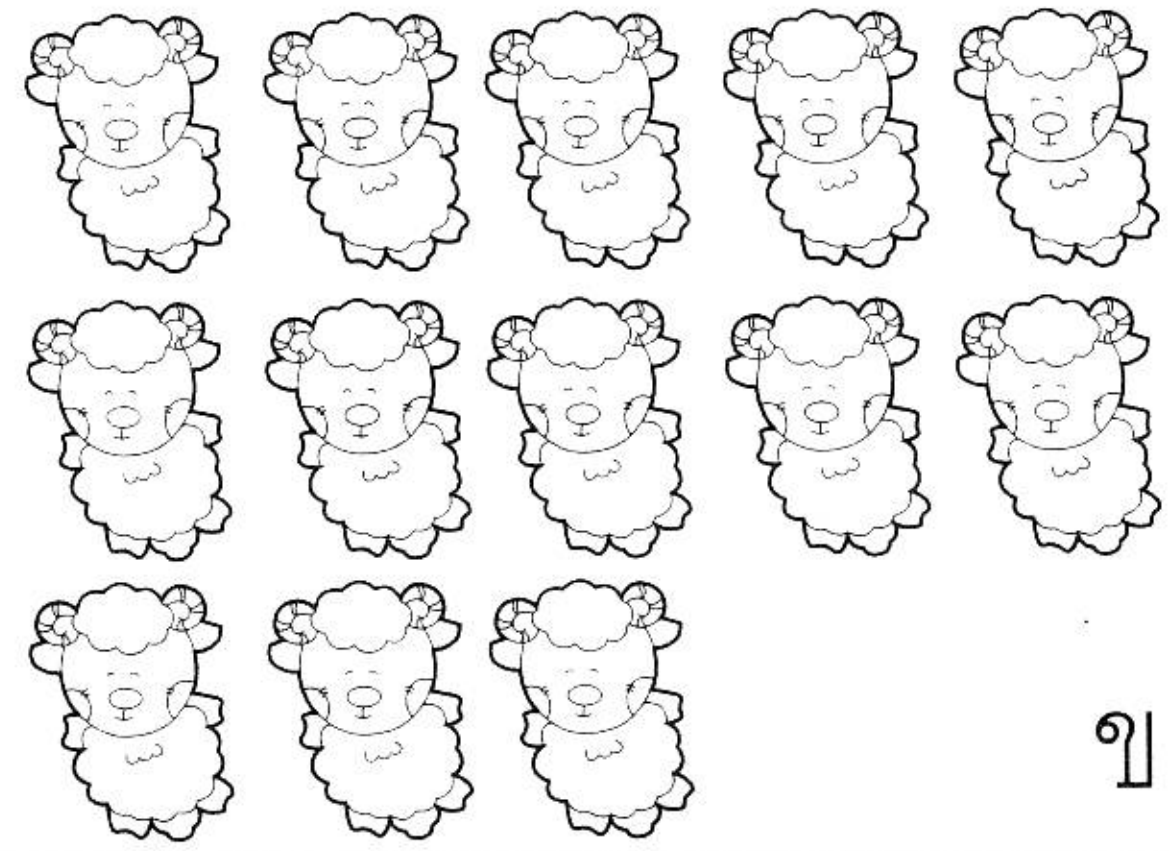

ข

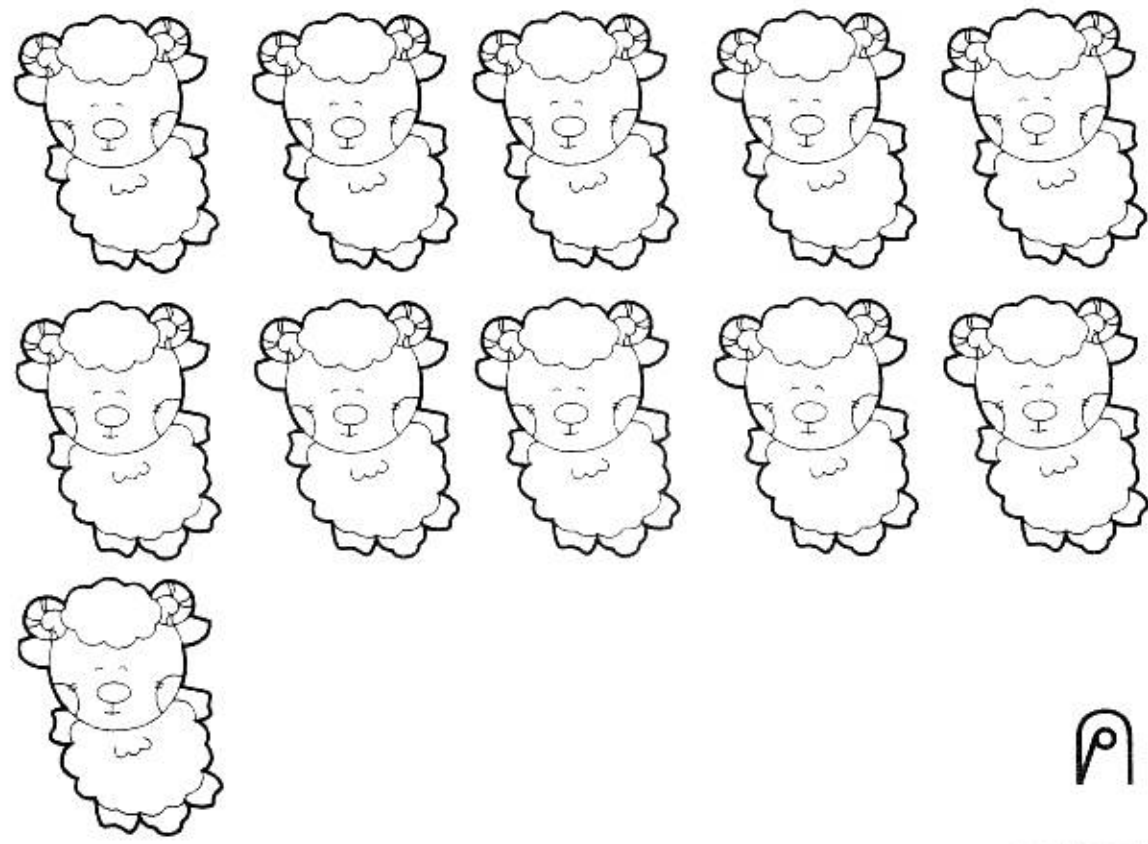

ค

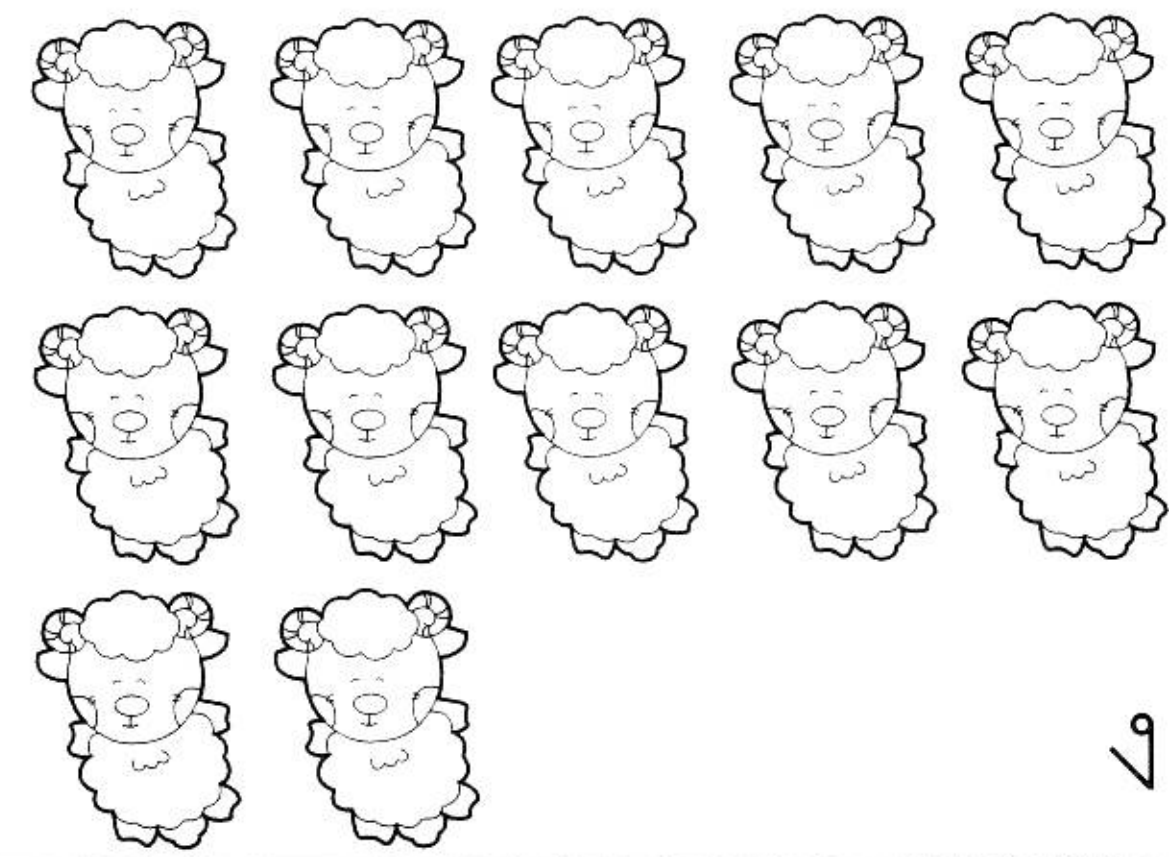

ง

30

มีวัวอยู่ 5 ตัว มีเต่า 2 ตัว  
จะมีวัวมากกว่าเต่ากี่ตัว

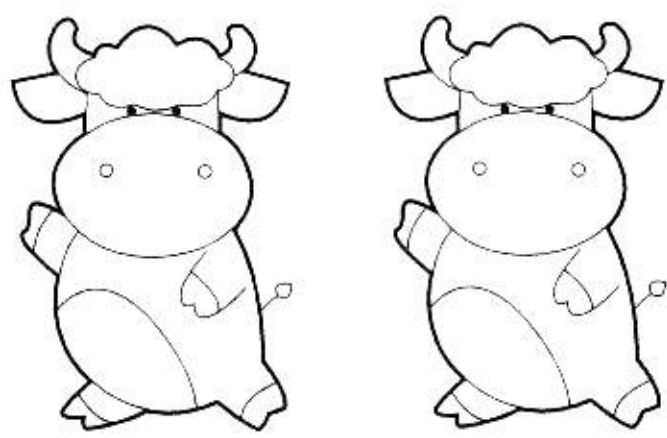

ก

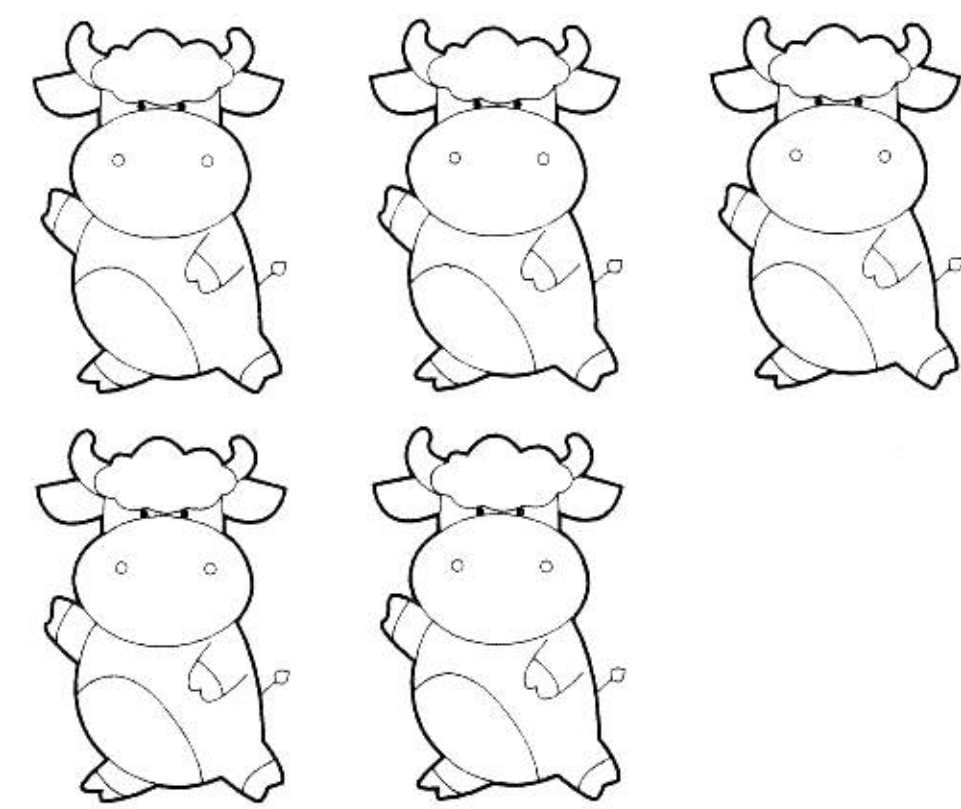

ข

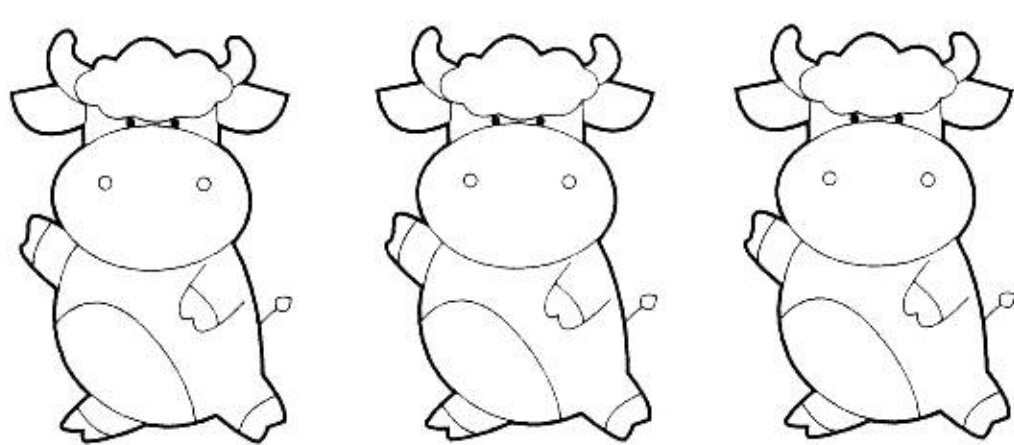

ค

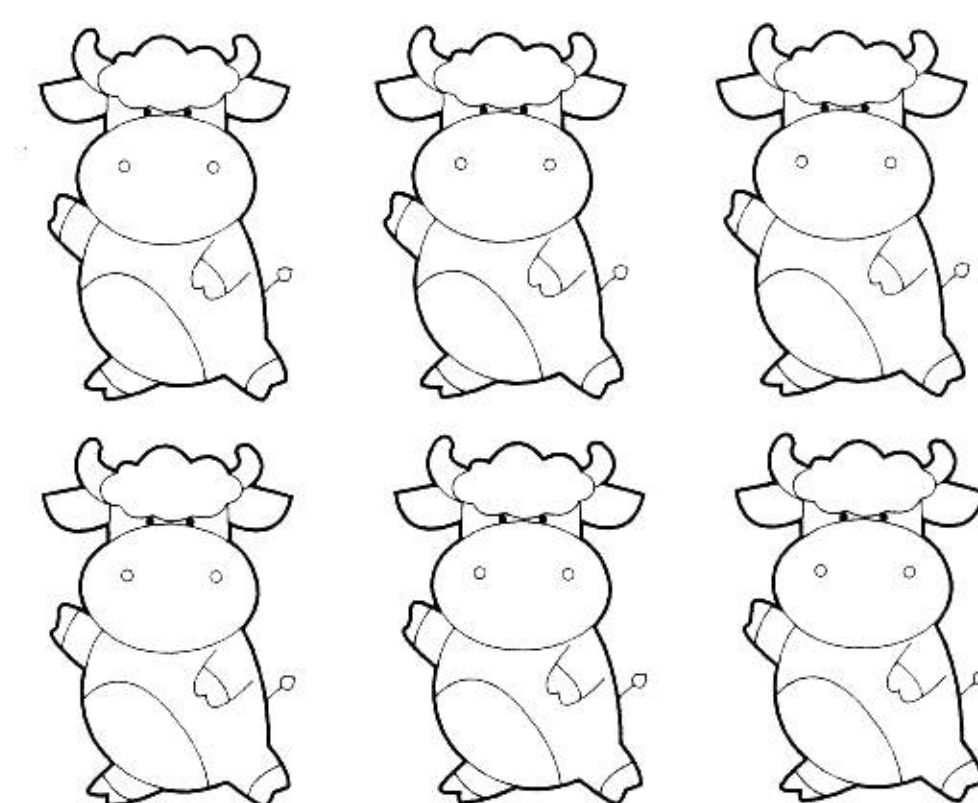

ง

จงนับจำนวนกล่องสีขาวที่สัมผัสกับกล่องสีเทาแล้ว **X** ข้อที่ถูก

1

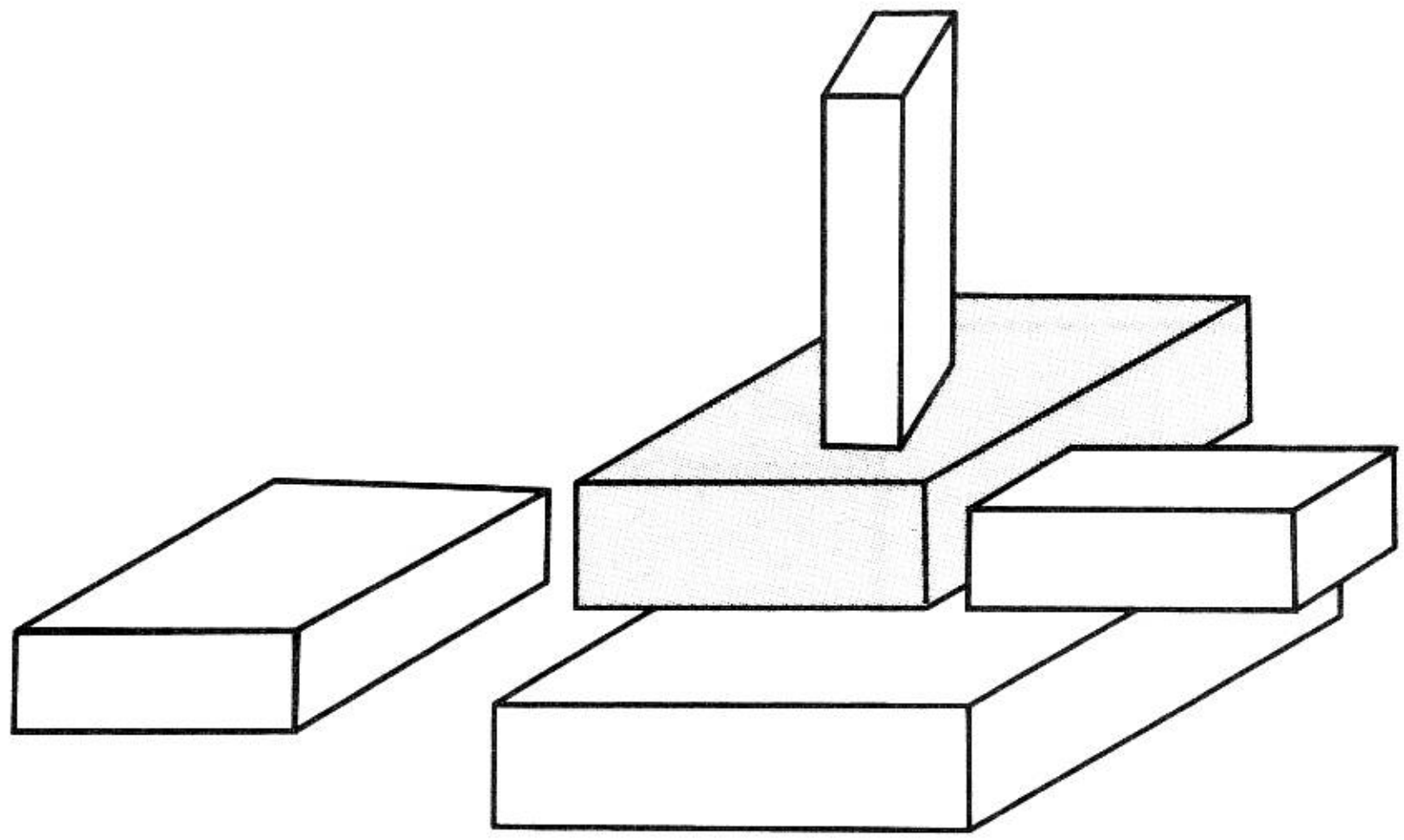

ก 5      ข 4      ค 3      ง 2

2

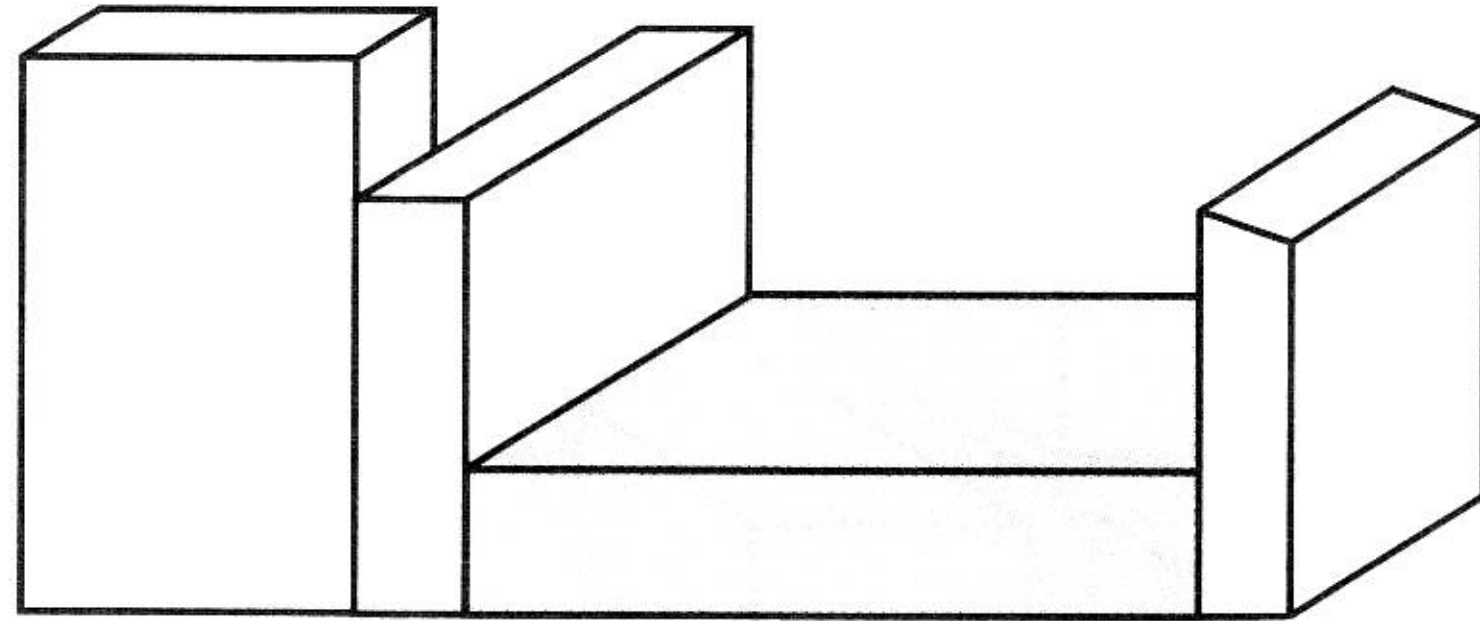

ก 1      ข 4      ค 3      ง 2

3

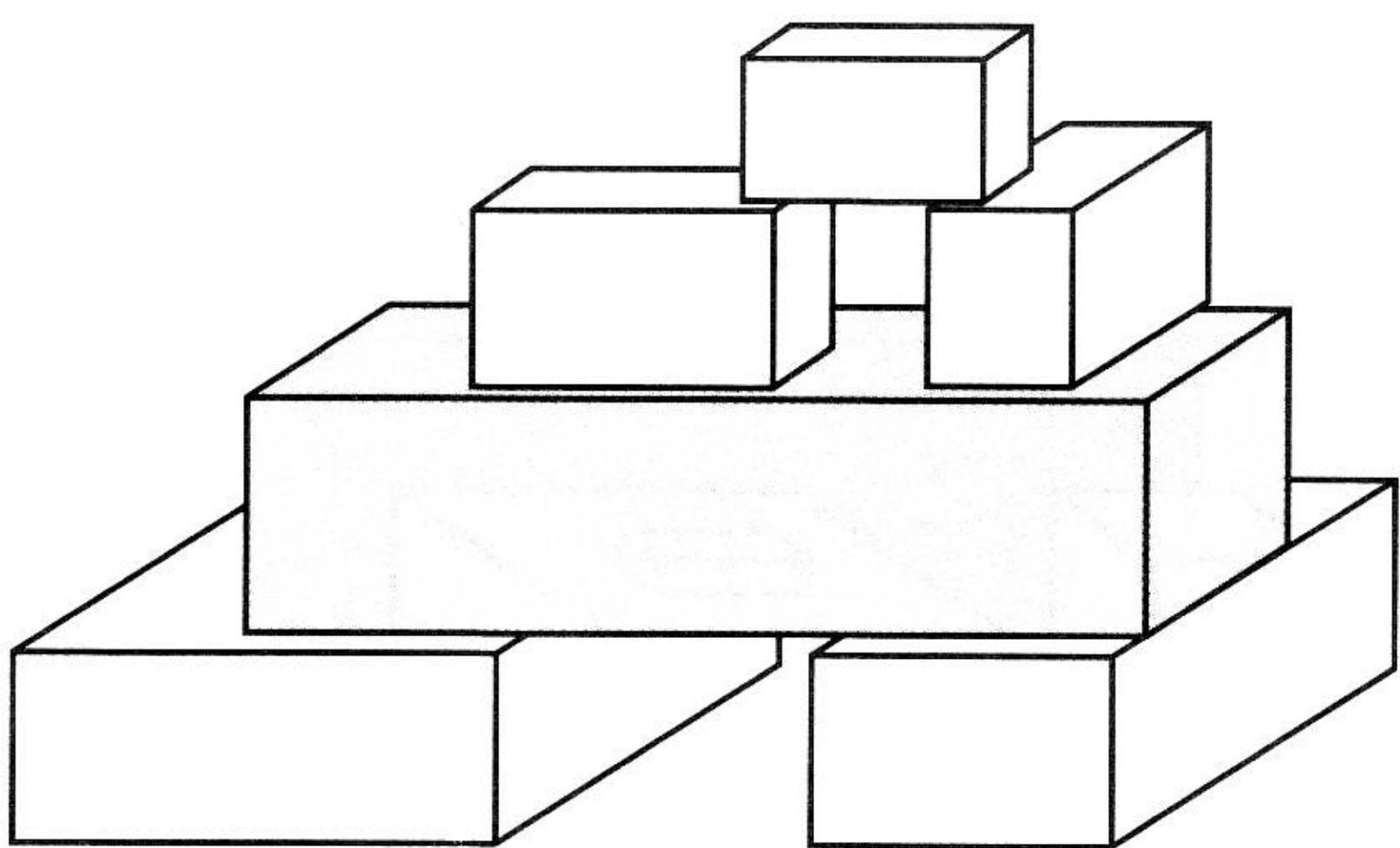

ก 2      ข 4      ค 3      ง 5

4

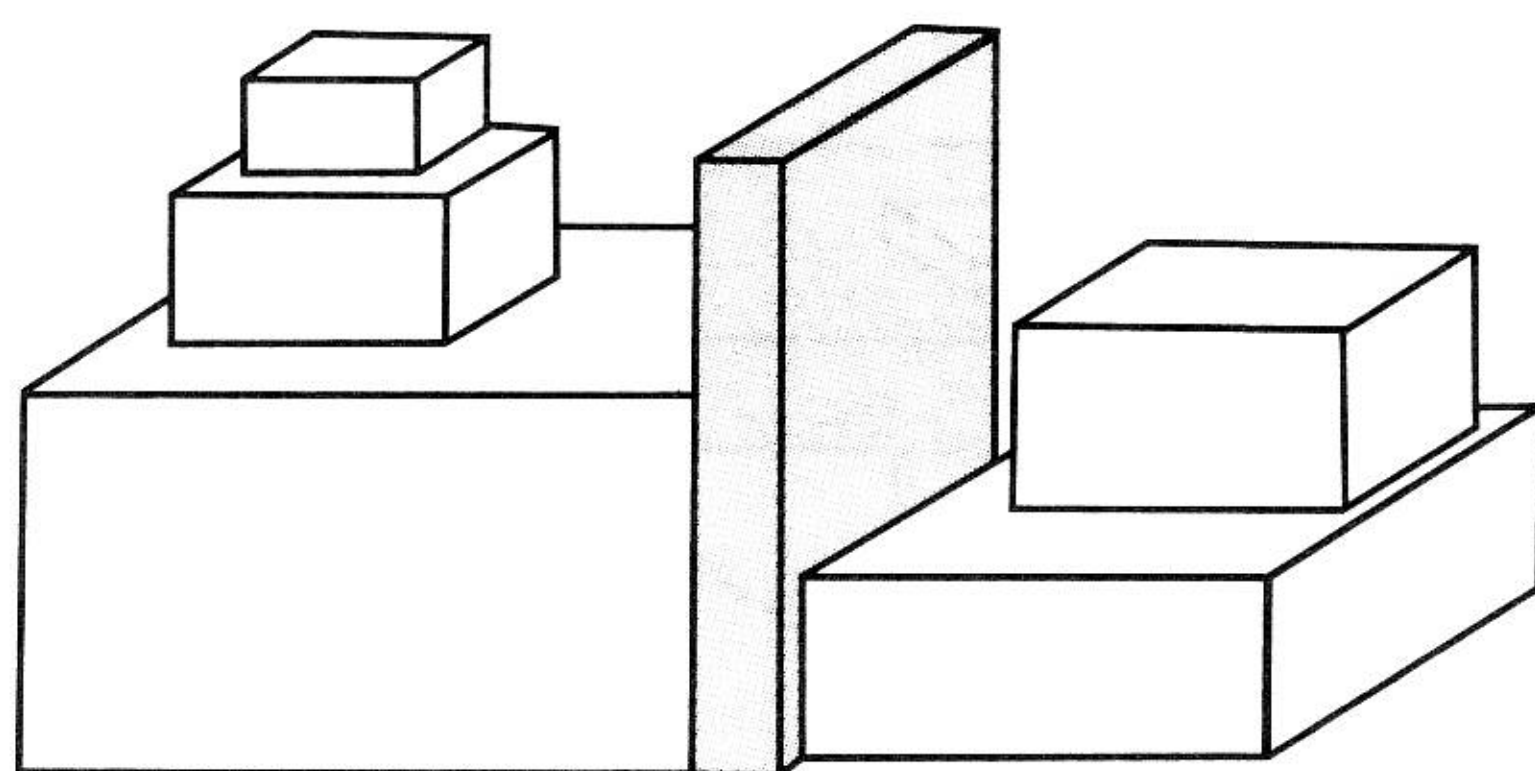

ก 3      ข 4      ค 2      ง 5

5

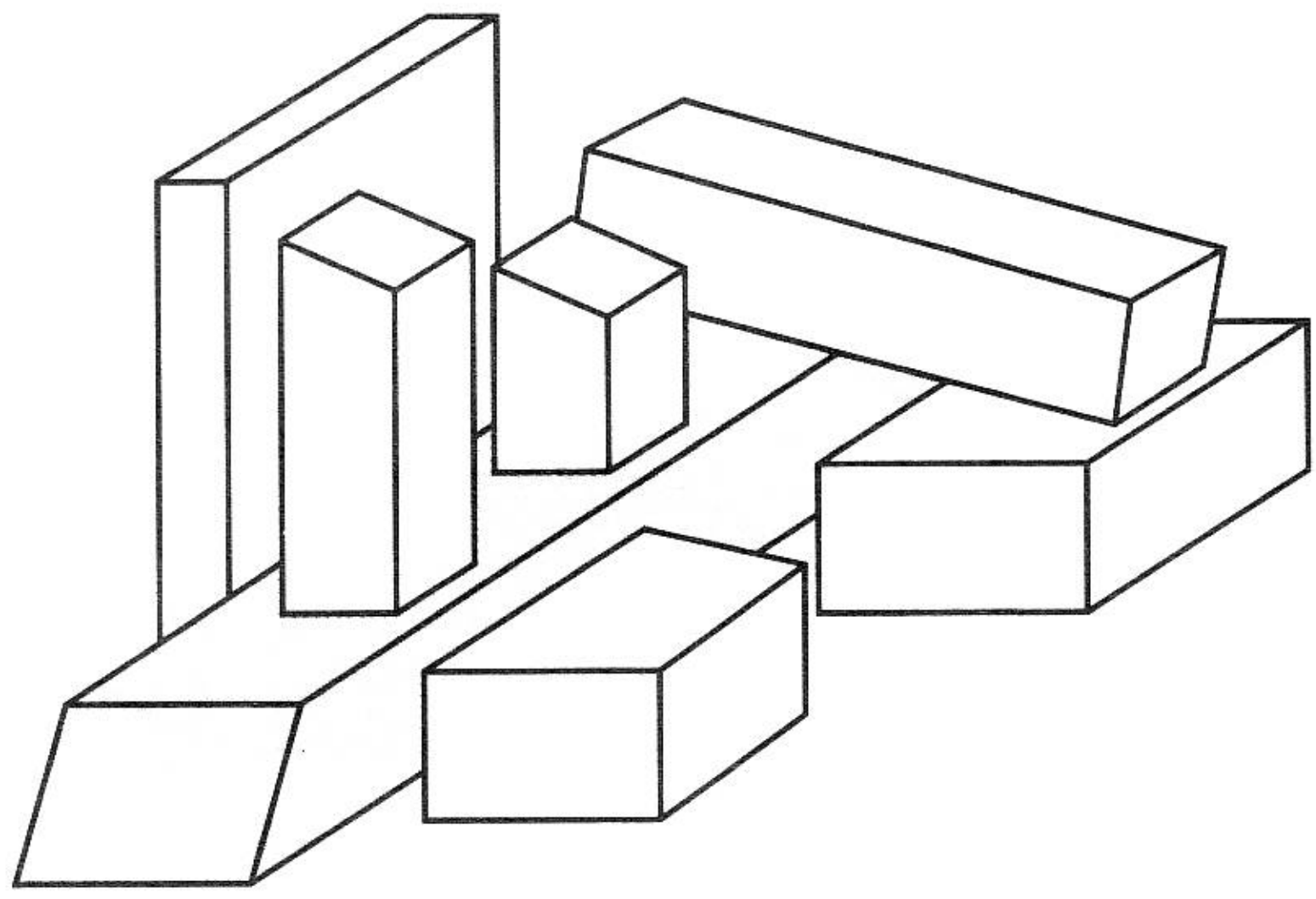

ก 3      ข 4      ค 5      ง 6

6

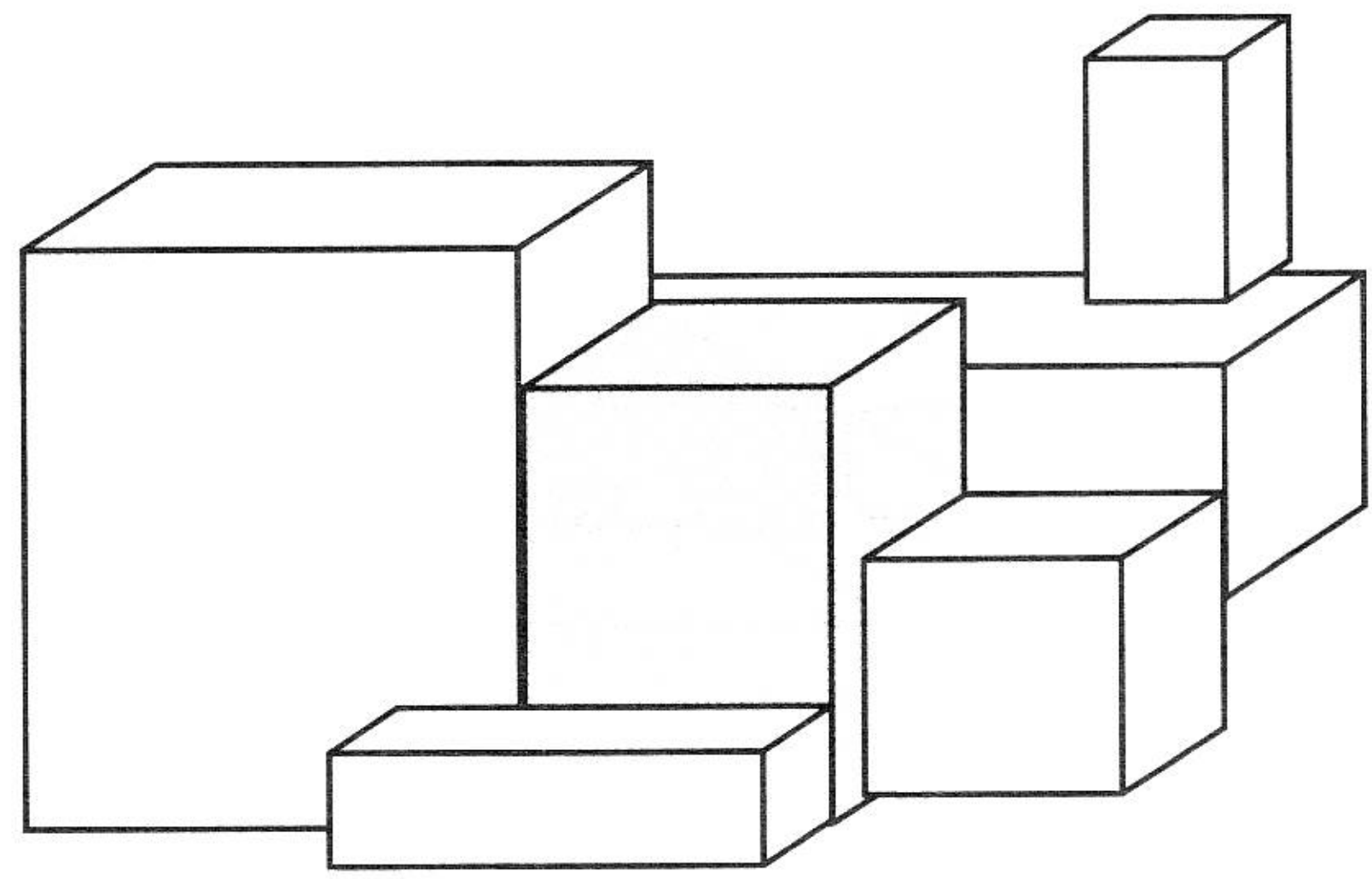

ก 6      ข 5      ค 4      ง 3

7

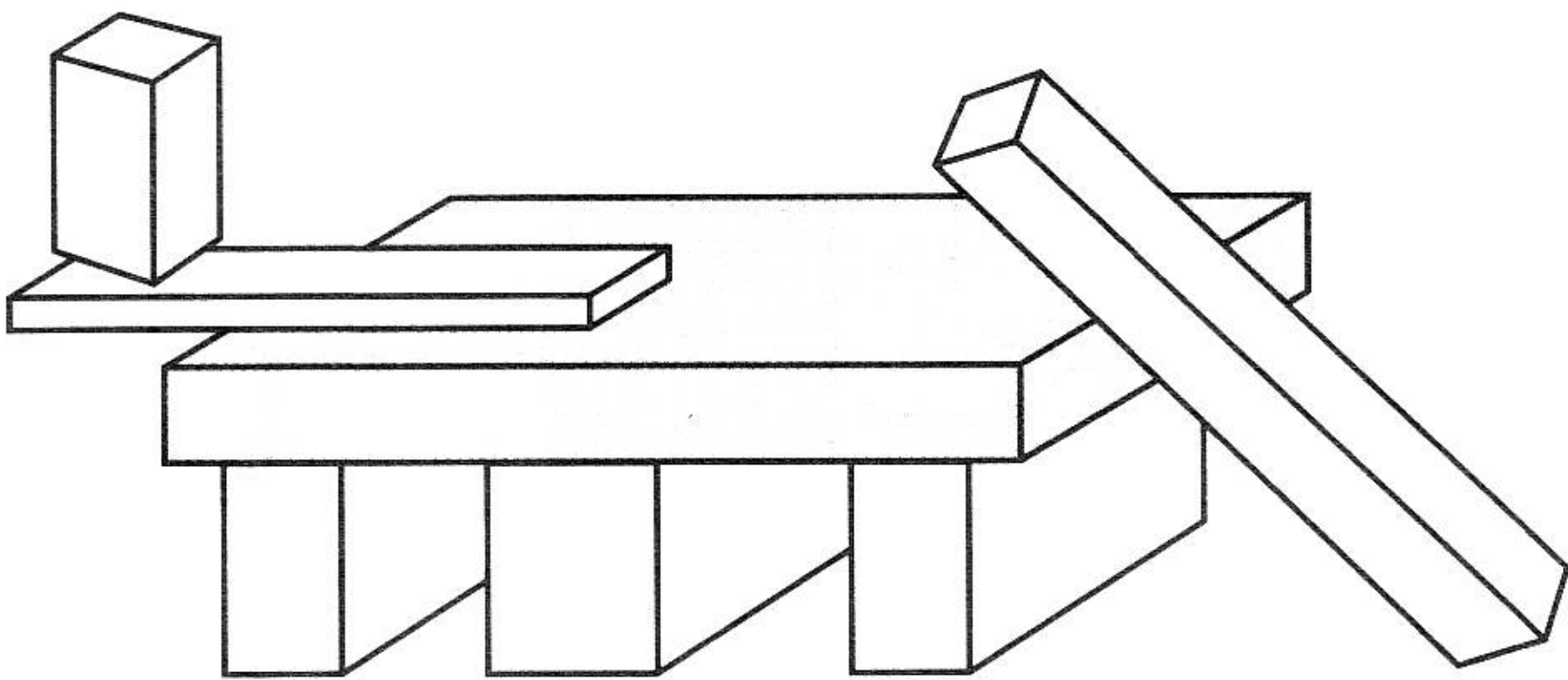

ก 3      ข 4      ค 6      ง 5

8

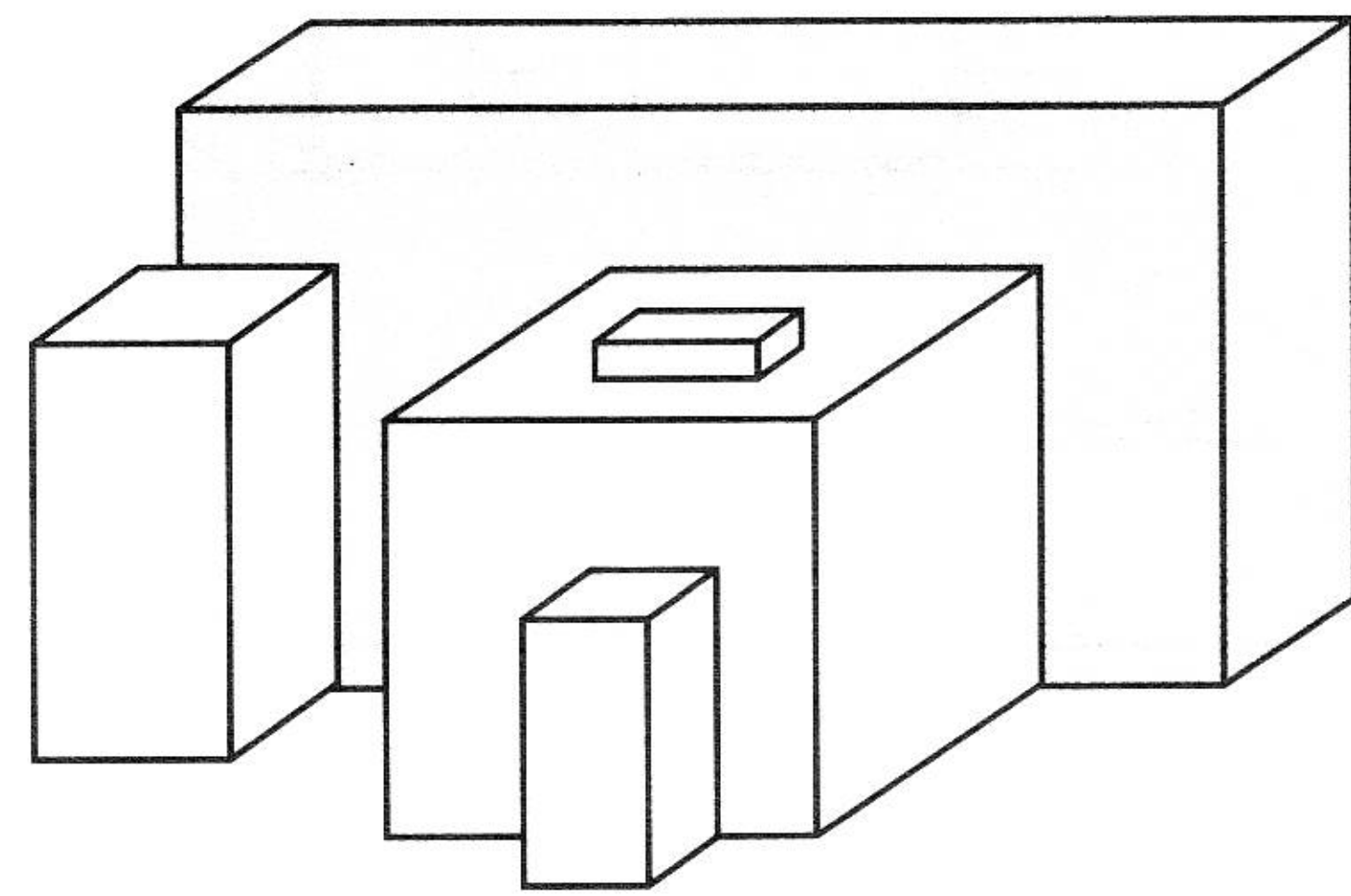

ก 5      ข 4      ค 3      ง 2

9

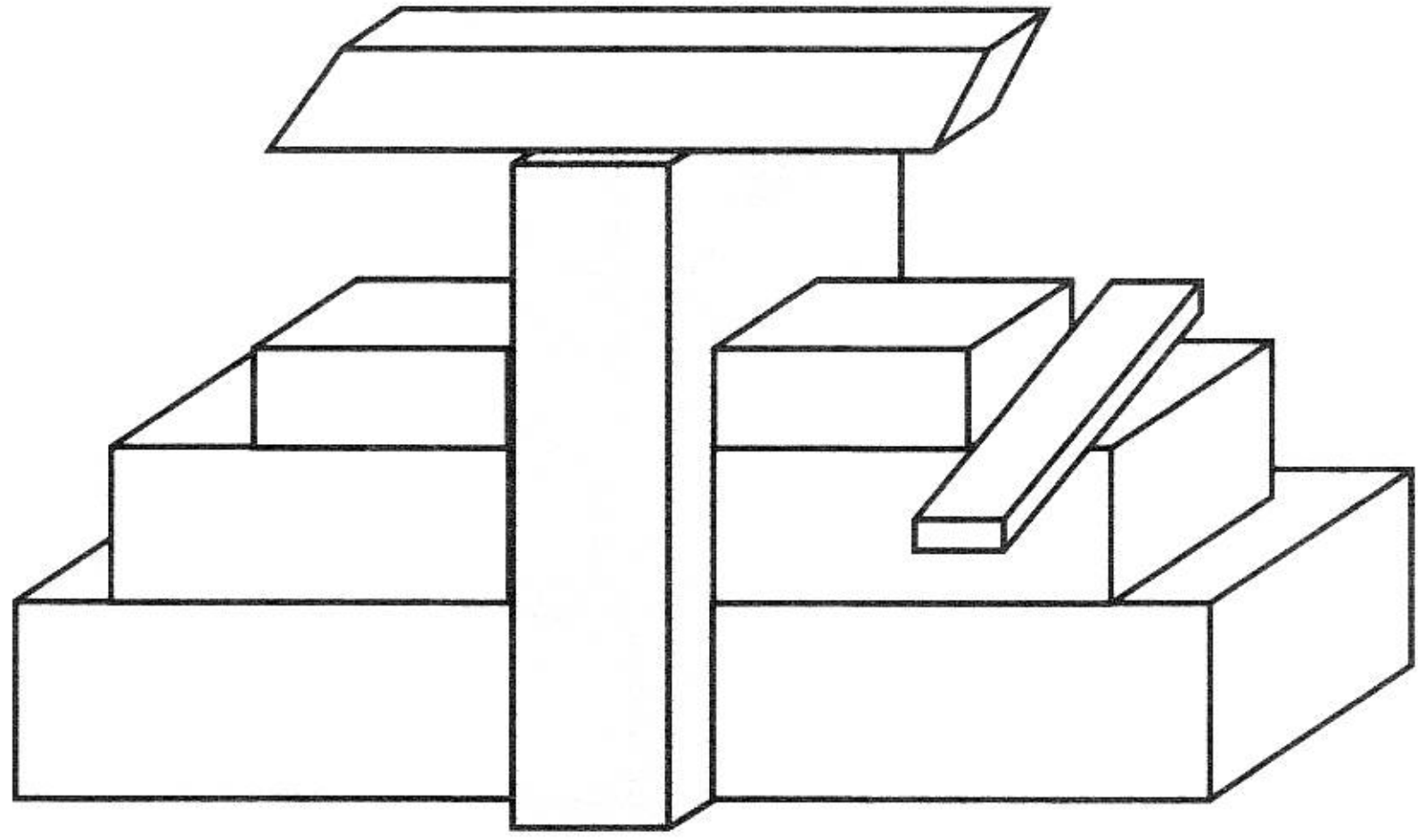

ก 5      ข 6      ค 7      ง 8

10

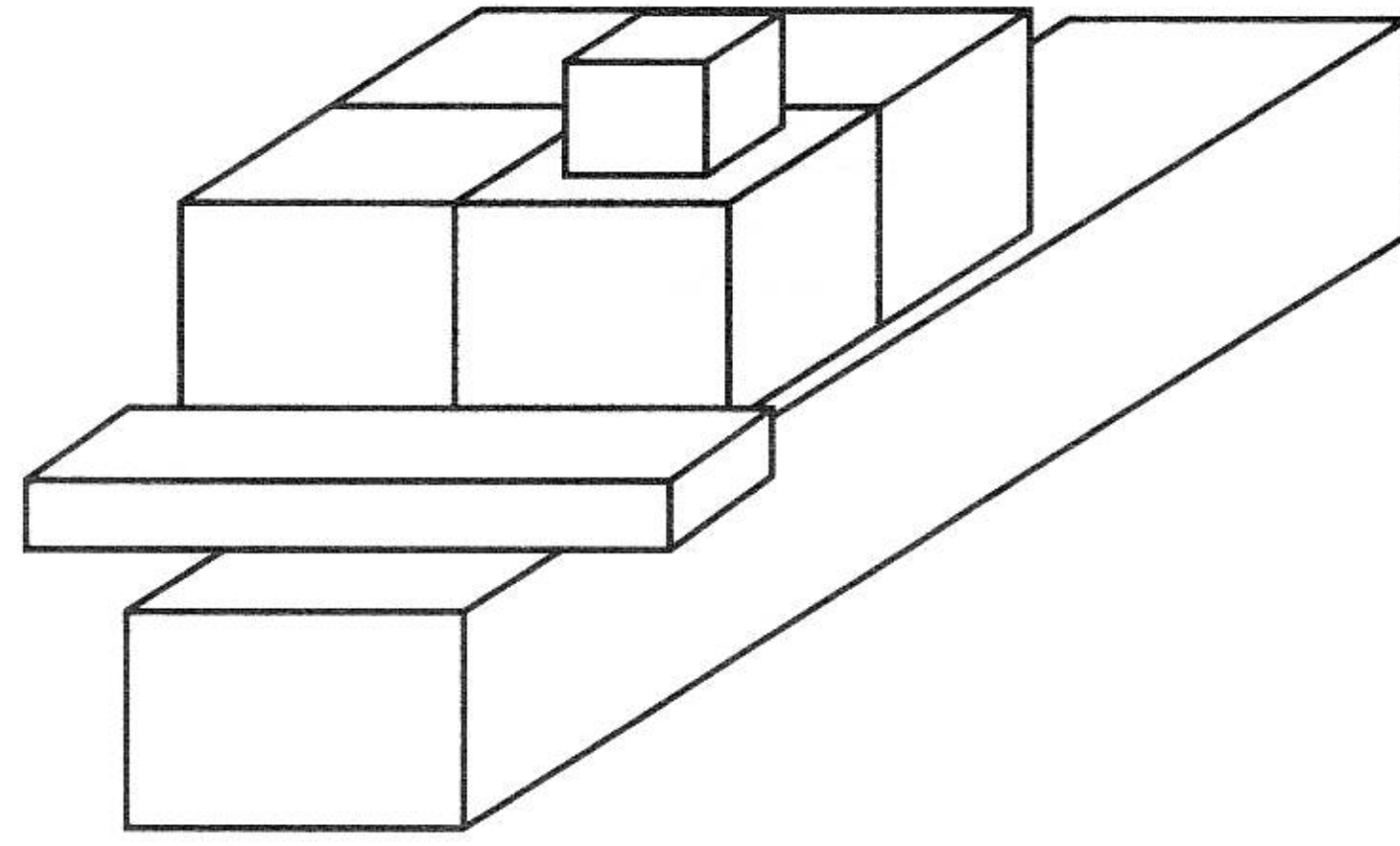

ก 5      ข 6      ค 7      ง 8

11

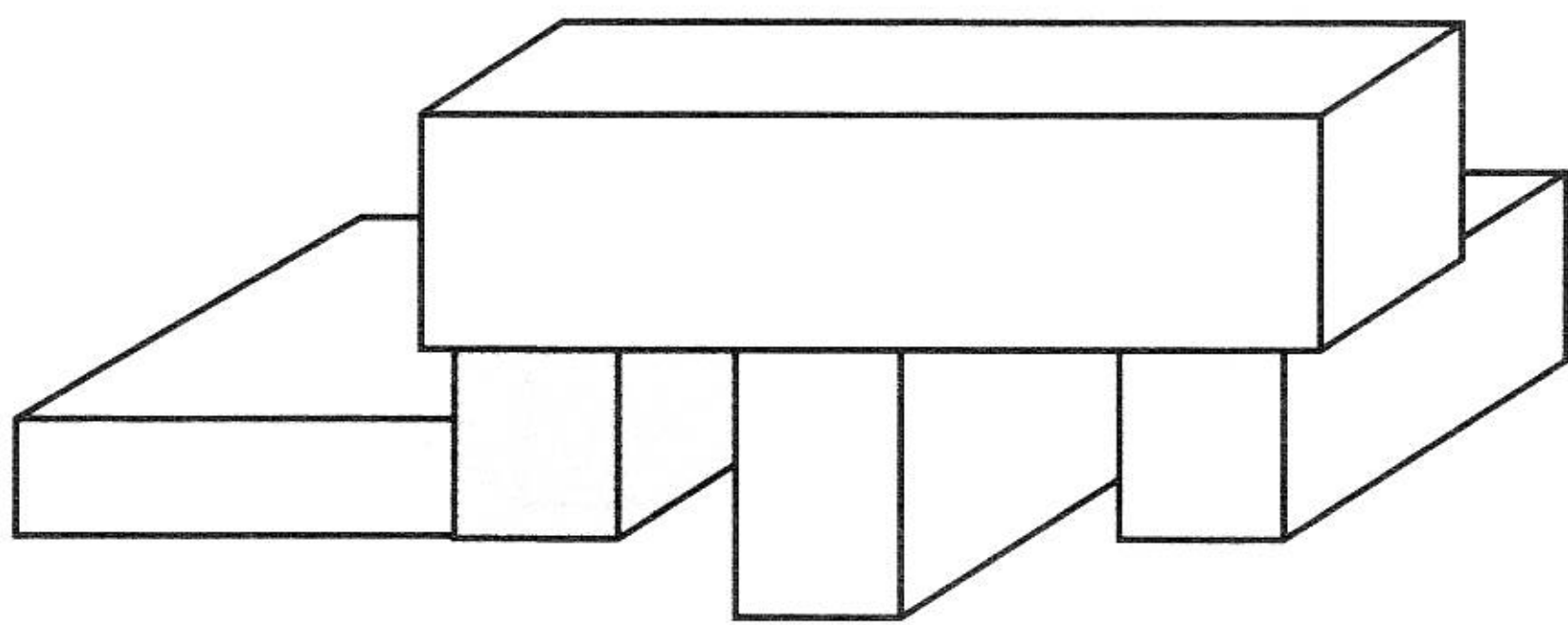

ก 4      ข 2      ค 3      ง 1

12

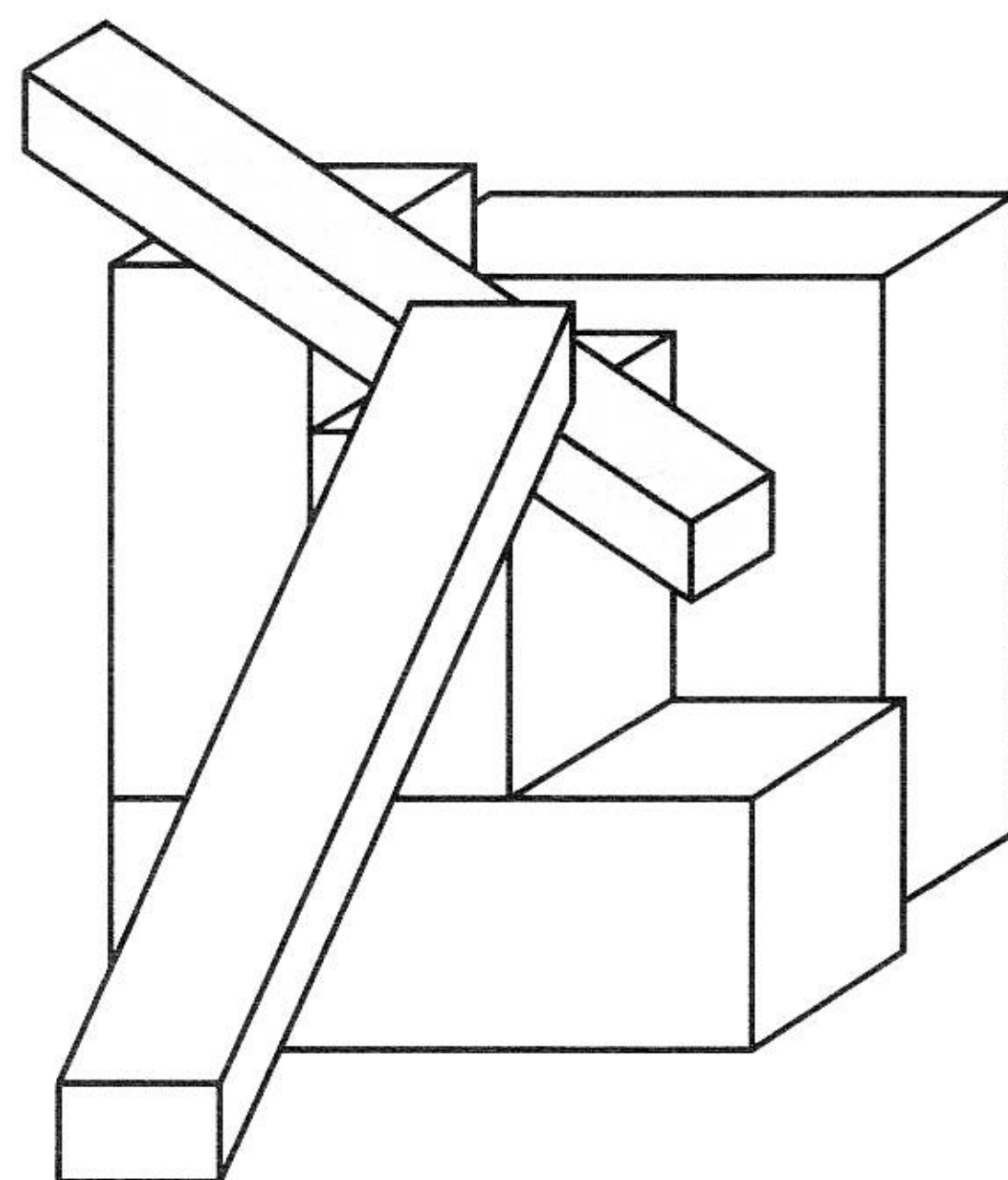

ก 3      ข 2      ค 5      ง 4

13

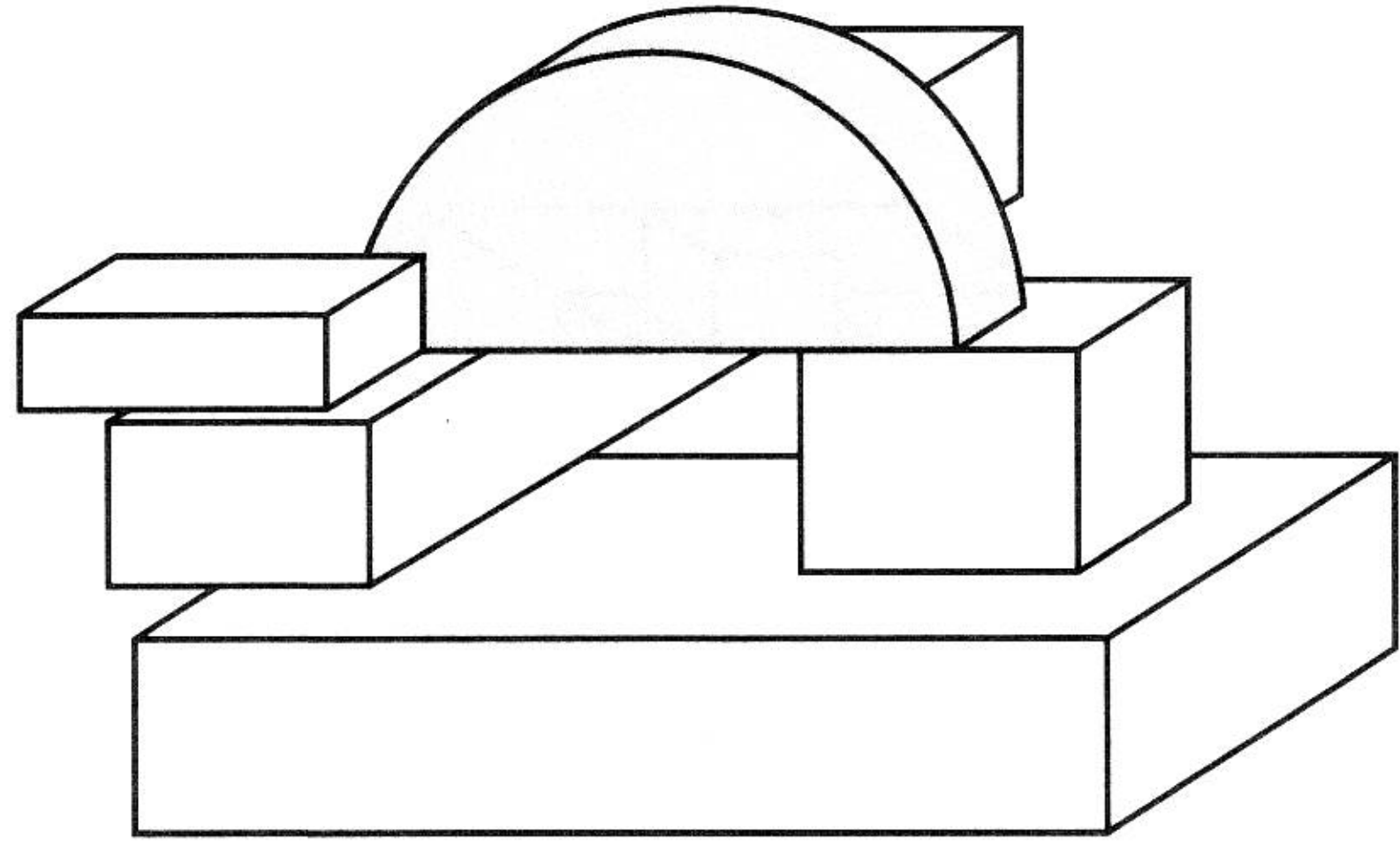

ก 2 ข 3 ค 4 ง 1

14

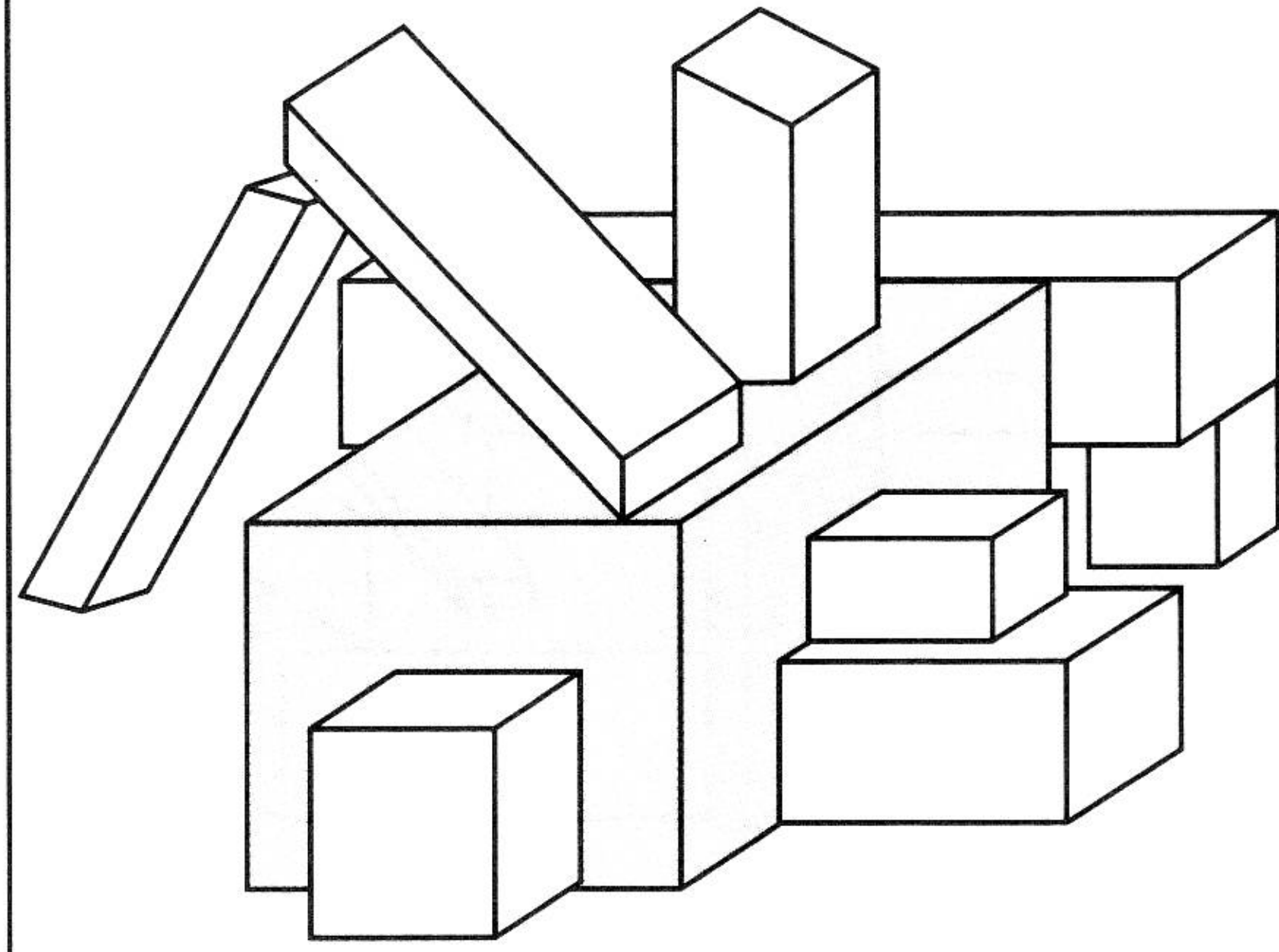

ก 7 ข 6 ค 4 ง 5

15

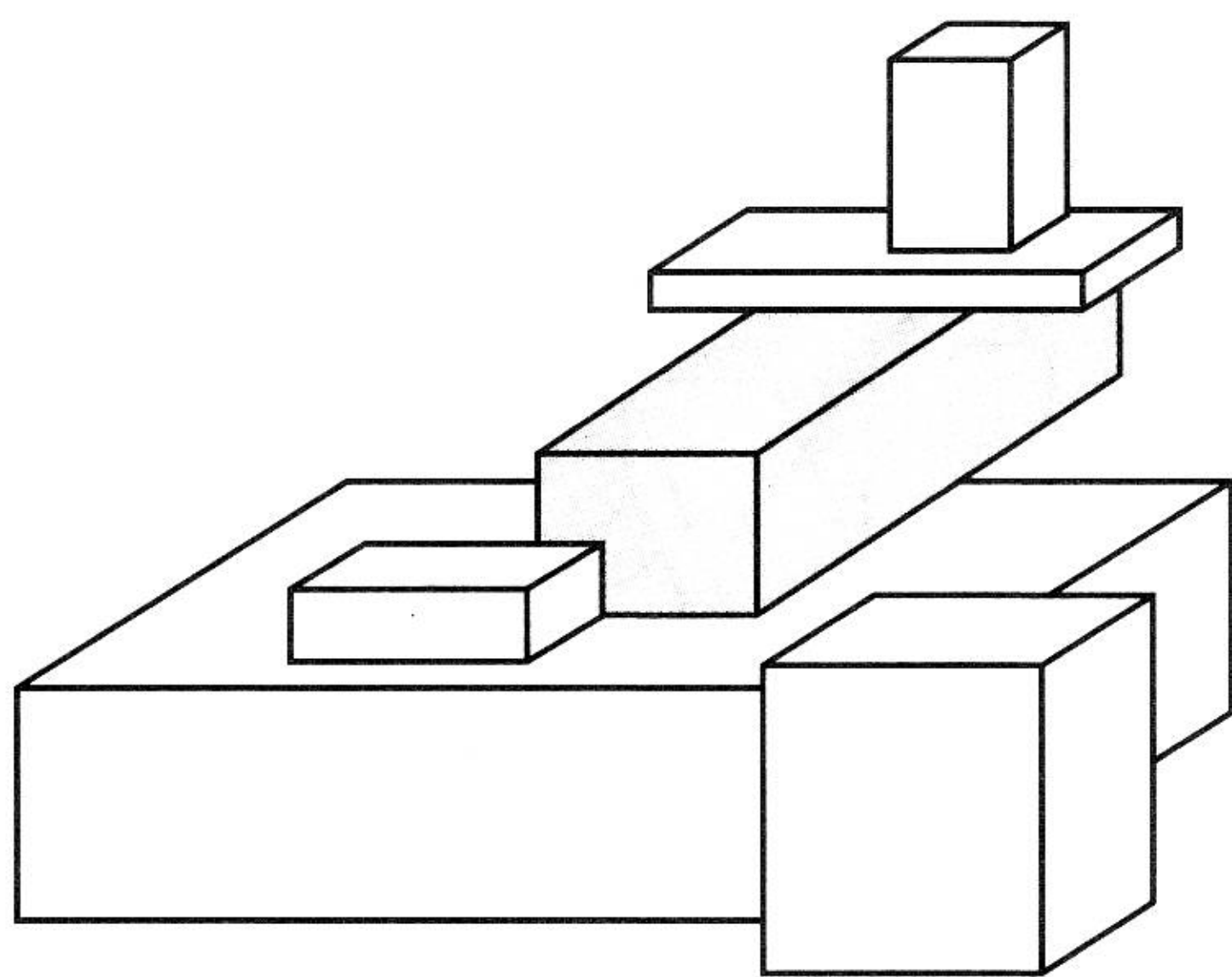

ก 3 ข 2 ค 5 ง 4

16

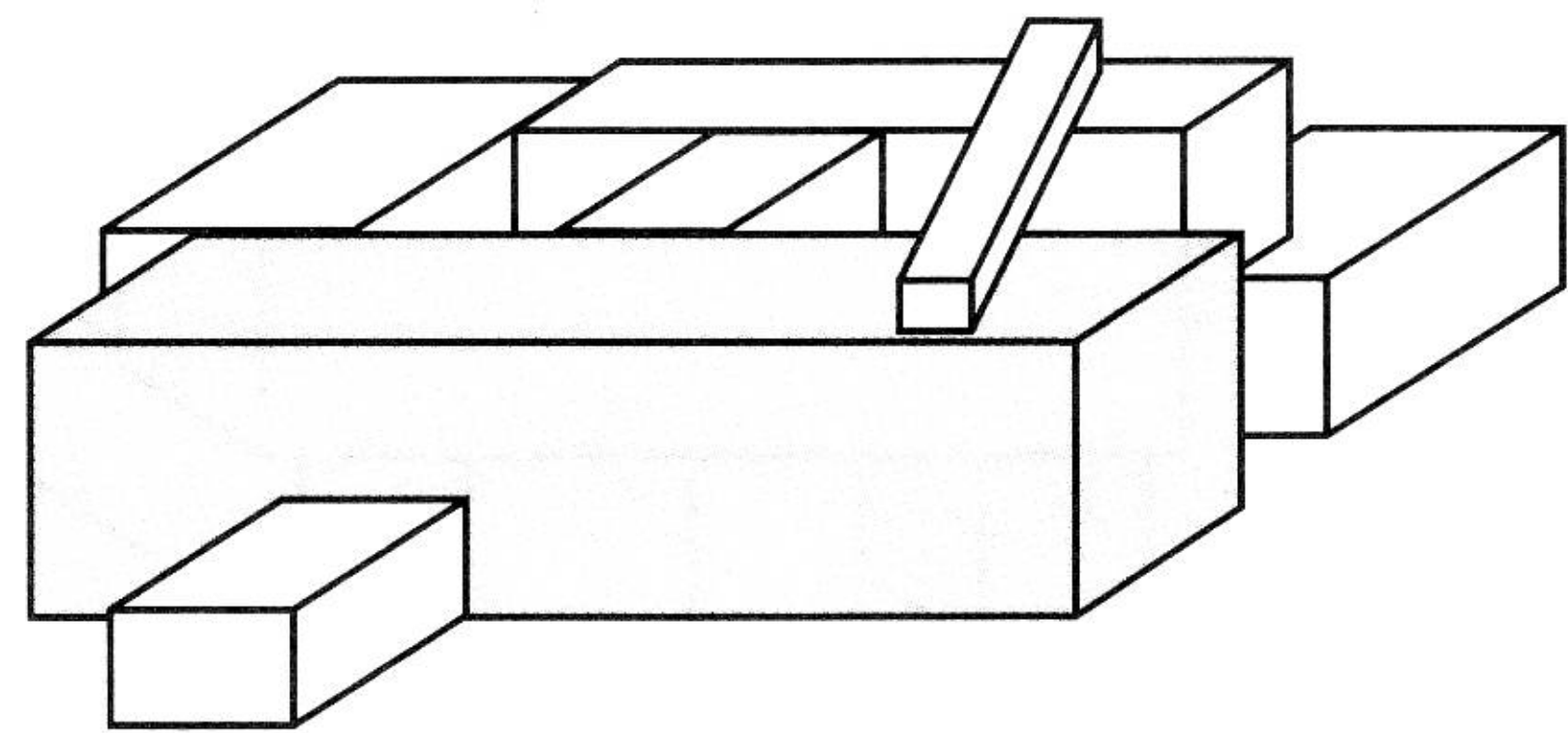

ก 3 ข 2 ค 4 ง 5

17

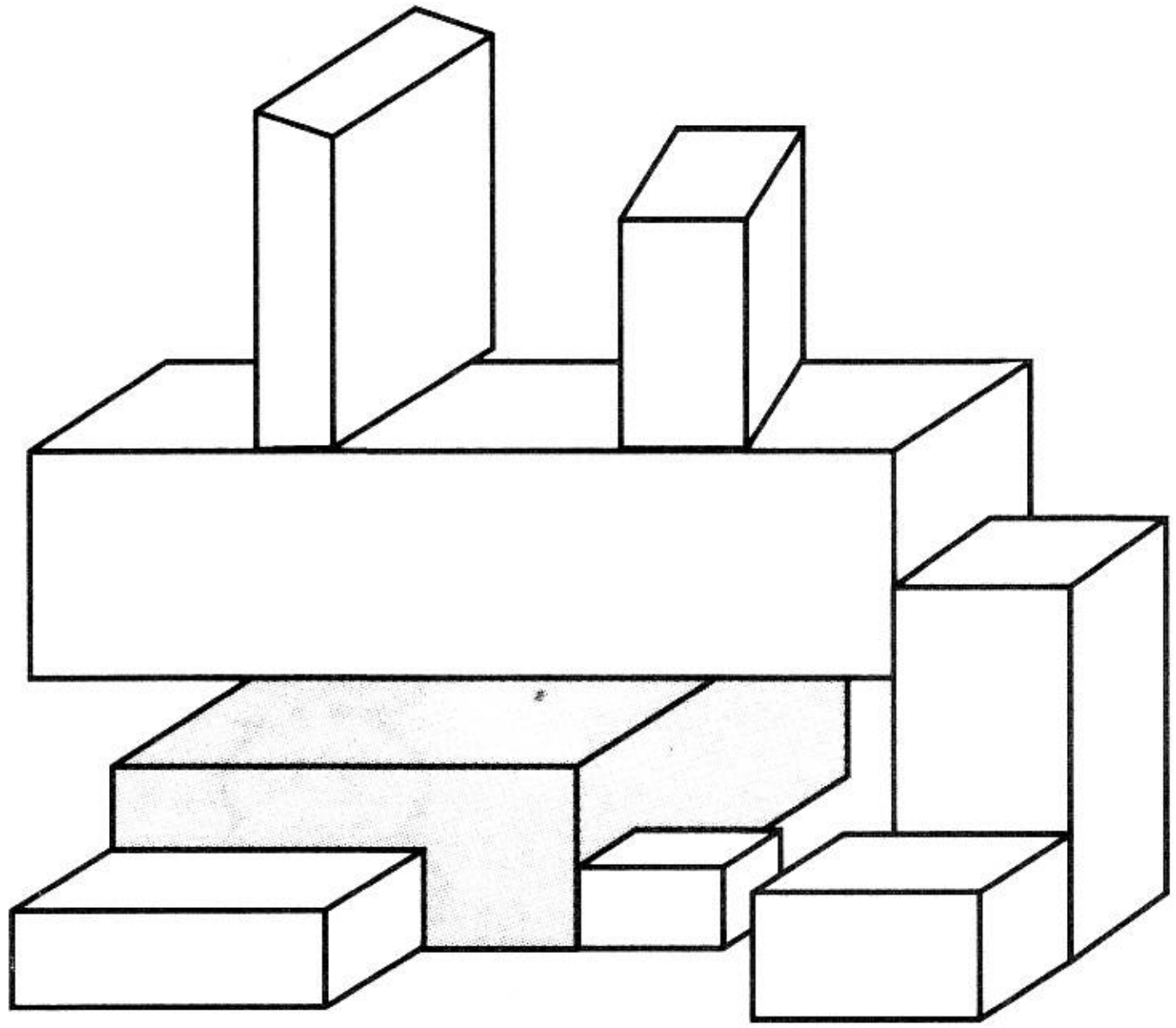

ก 5 ข 4 ค 3 ง 2

18

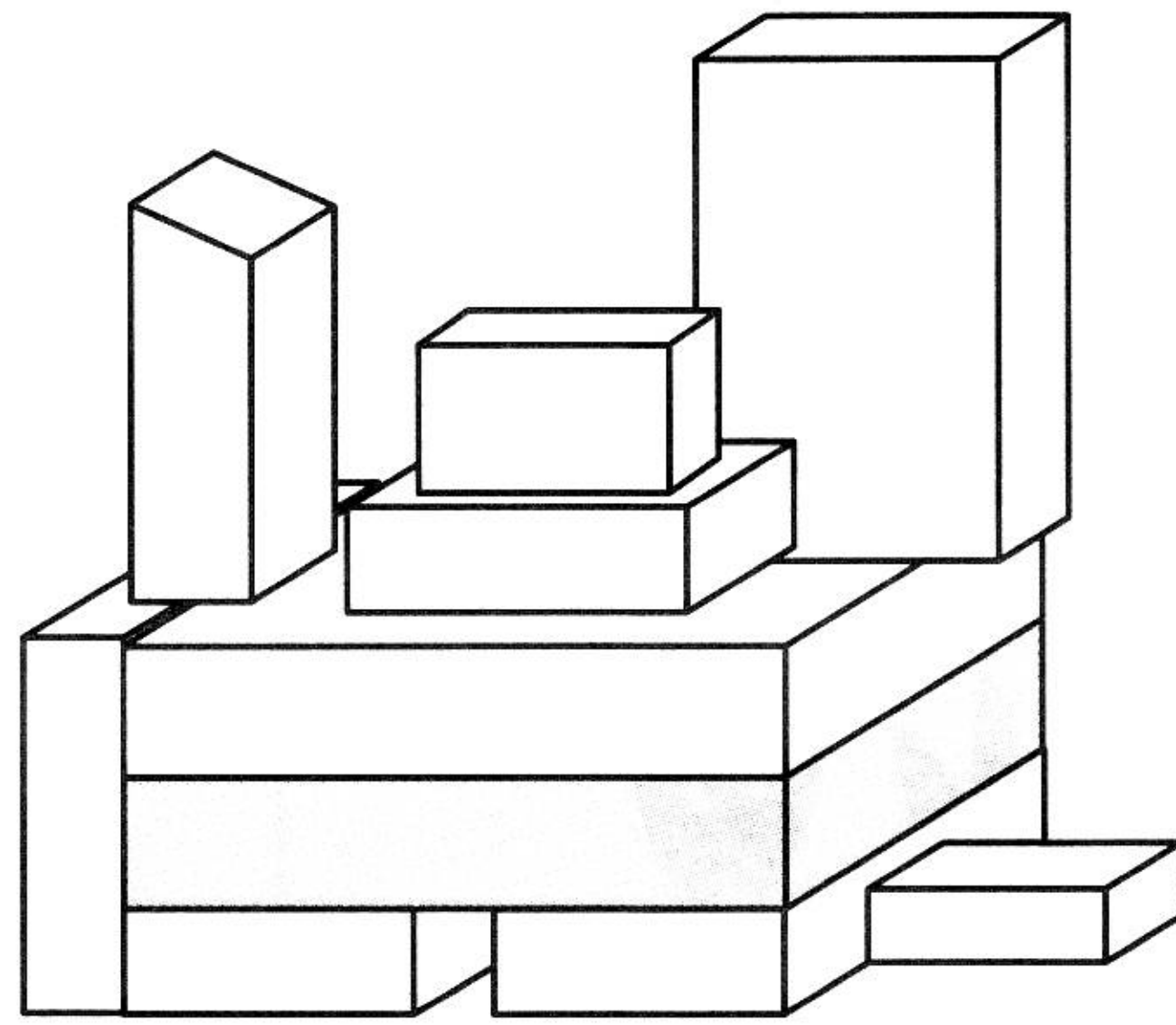

ก 7 ข 4 ค 3 ง 2

19

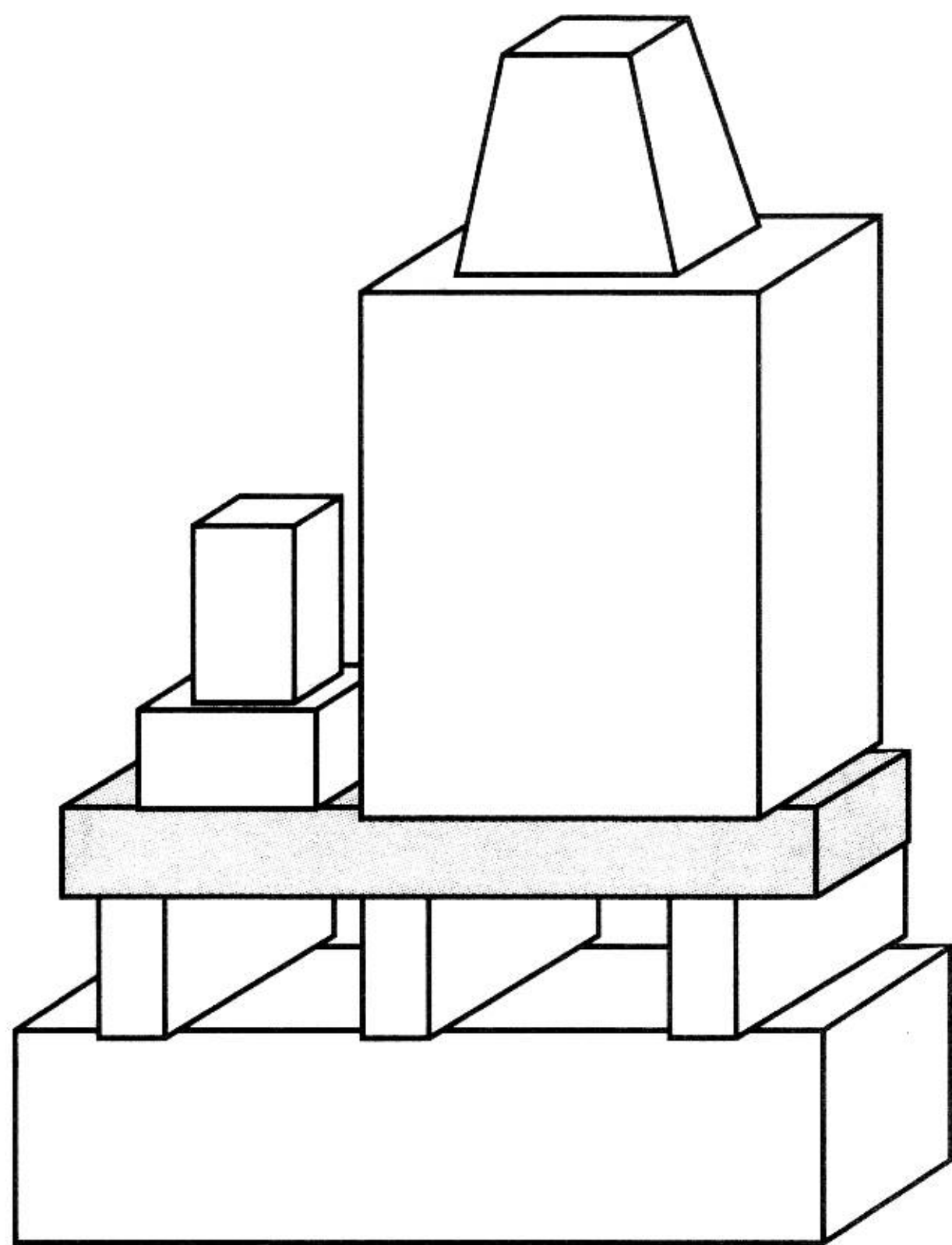

ก 2 ข 4 ค 3 ง 5

20

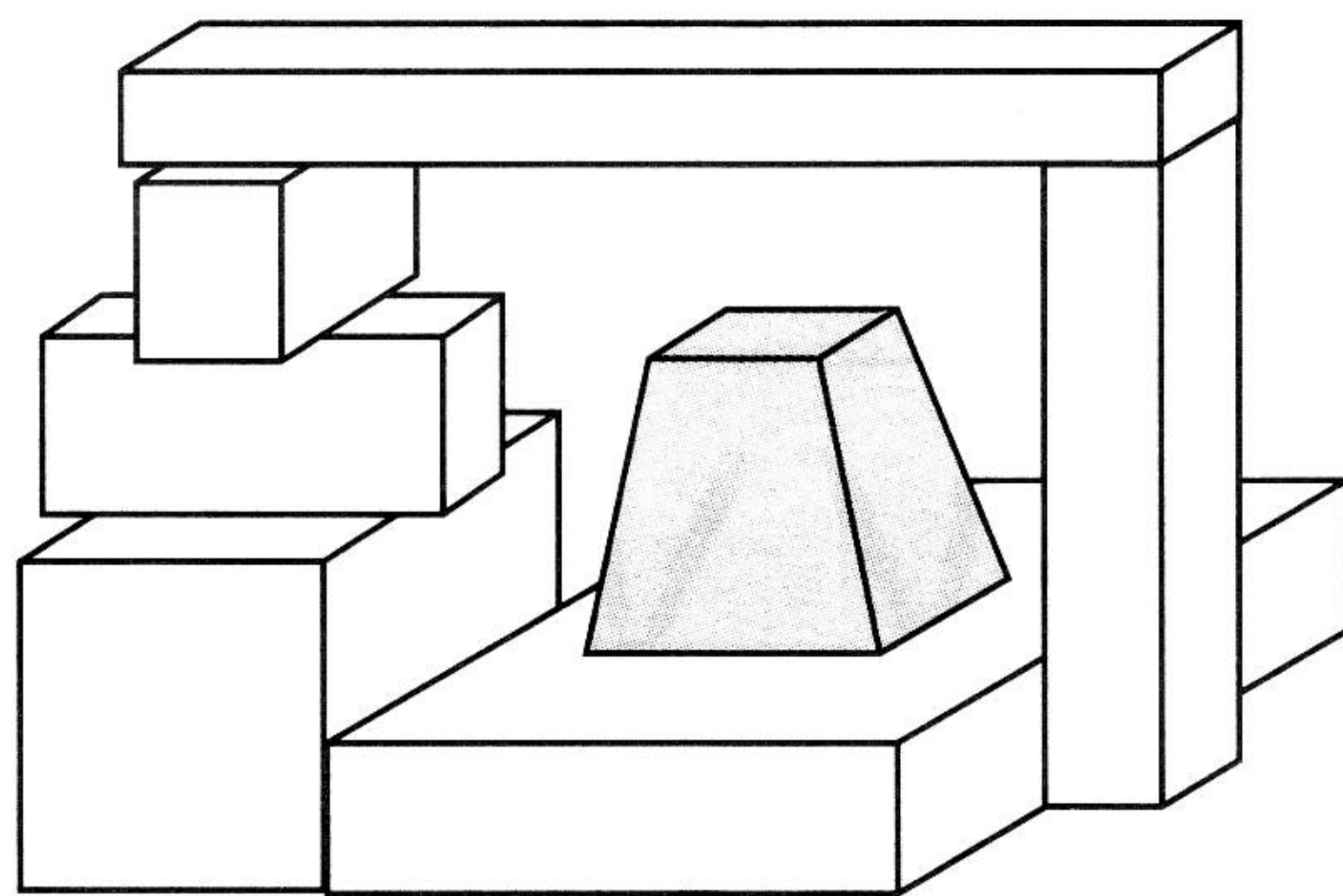

ก 1 ข 3 ค 2 ง 4





จงขีด ✓ ข้อที่มีสัตว์ตรงกับจำนวนรอยเท้าในช่องแรก

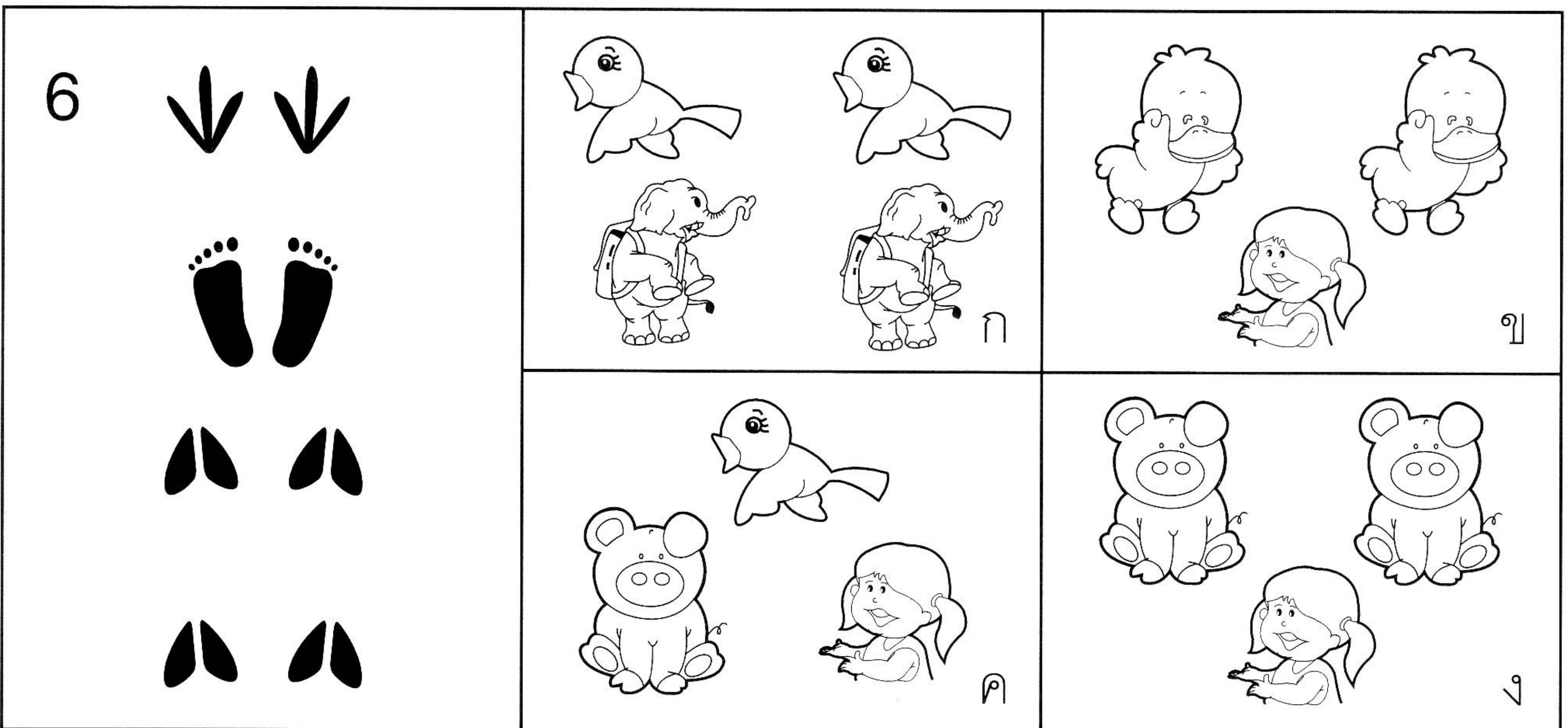
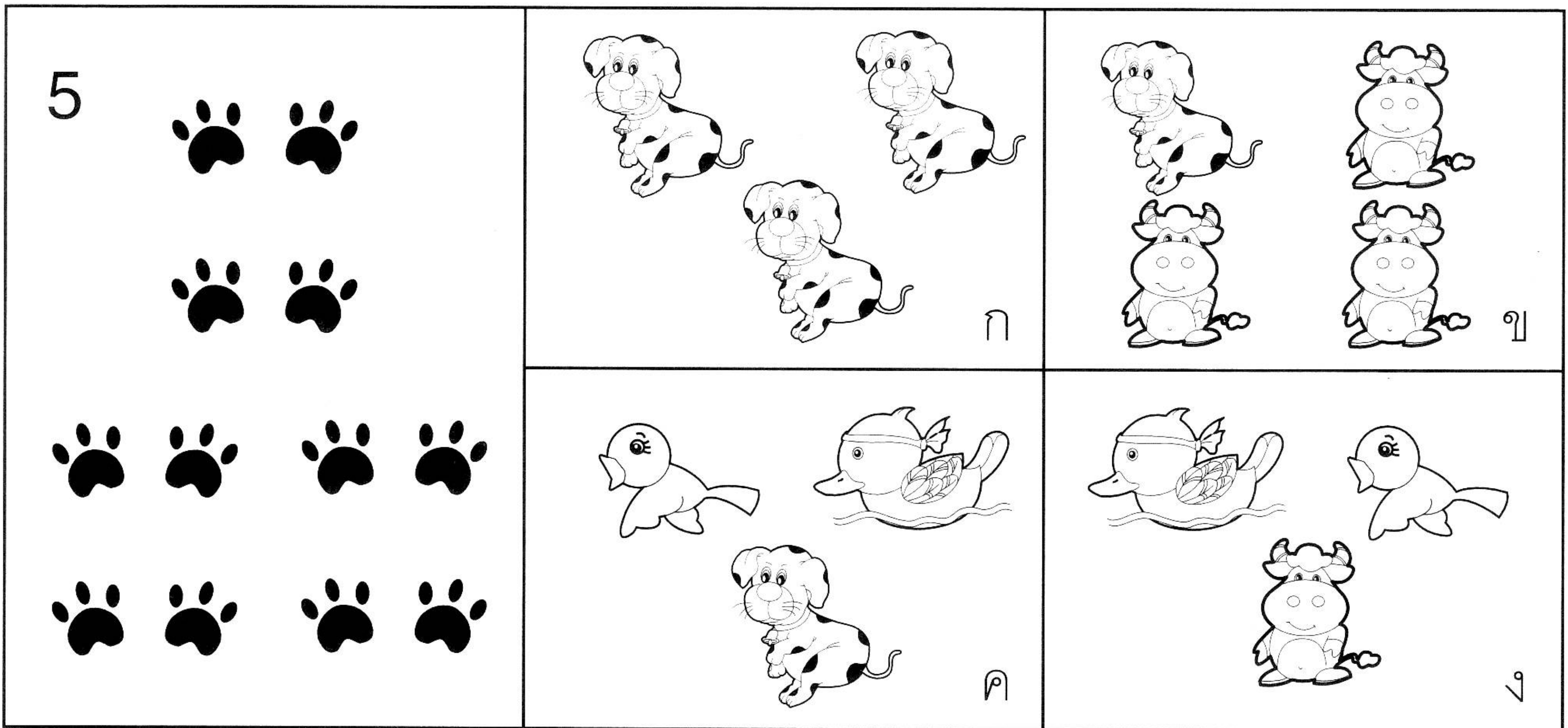
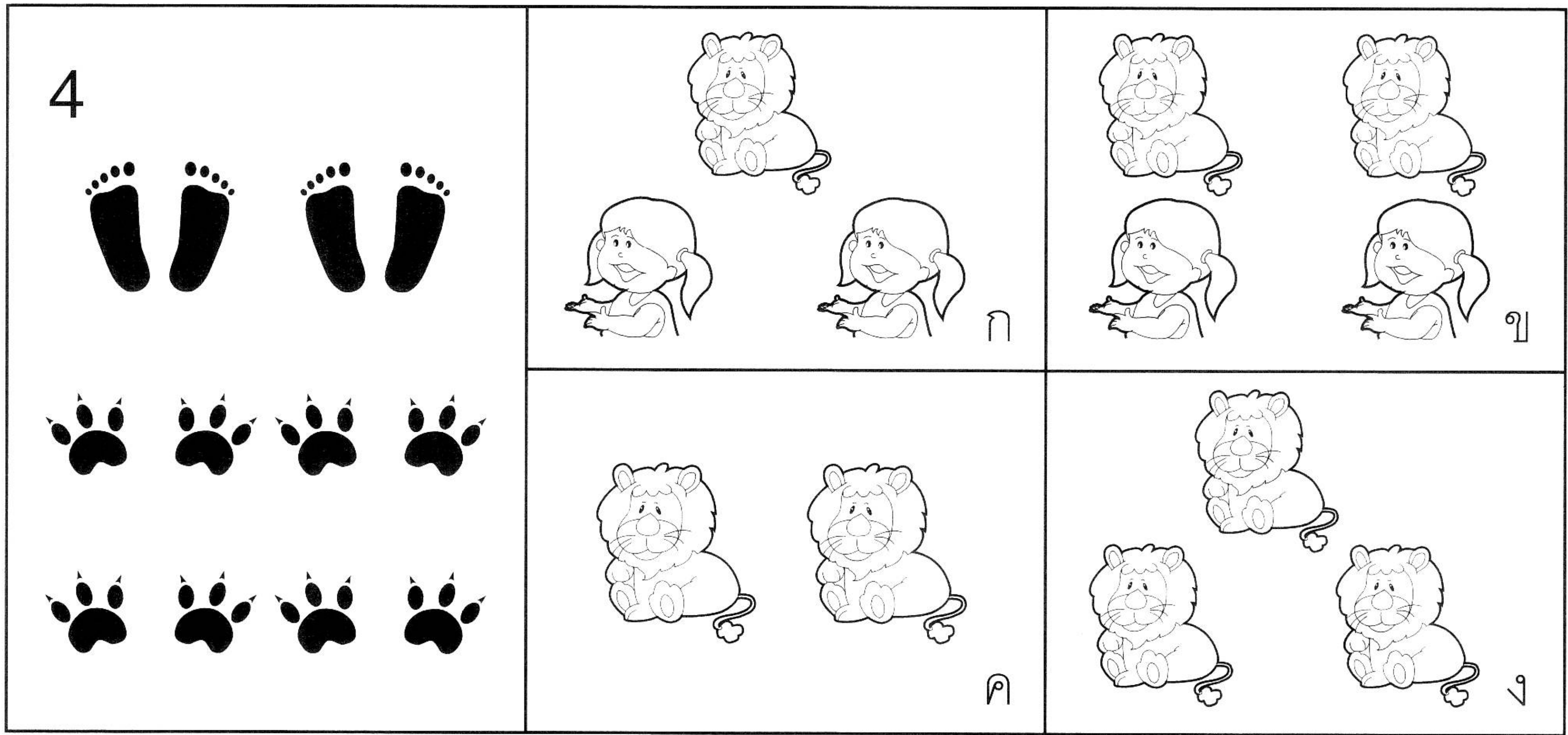

1			

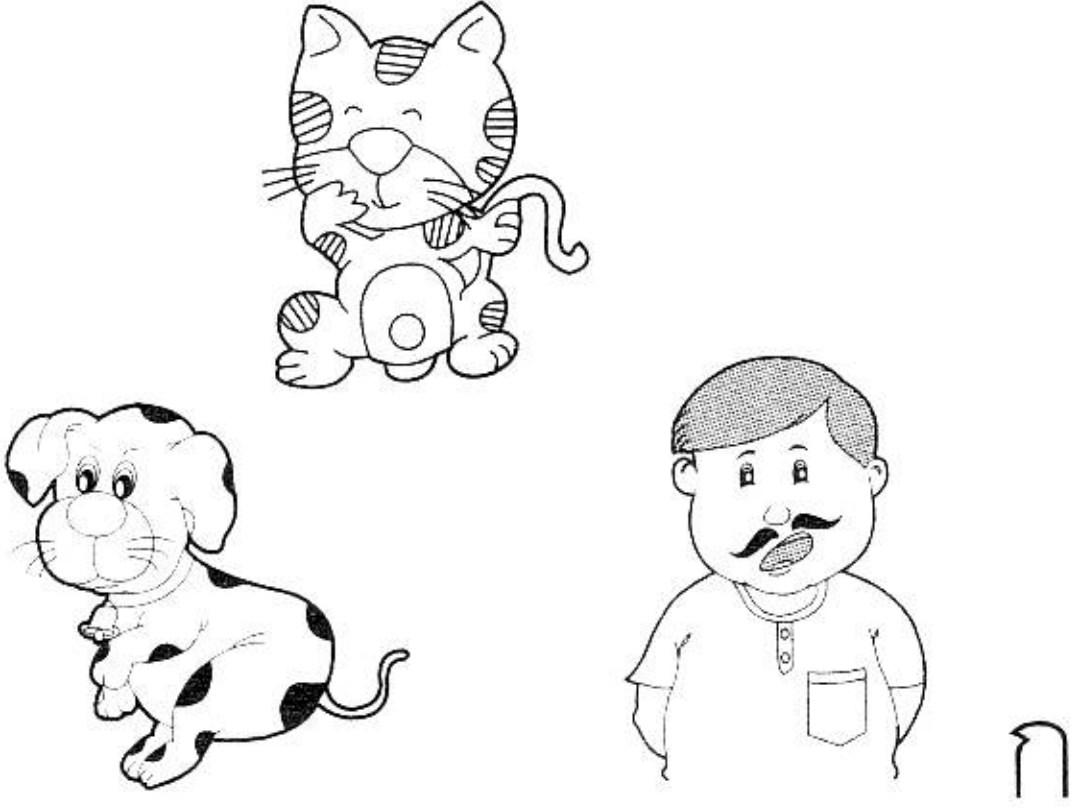
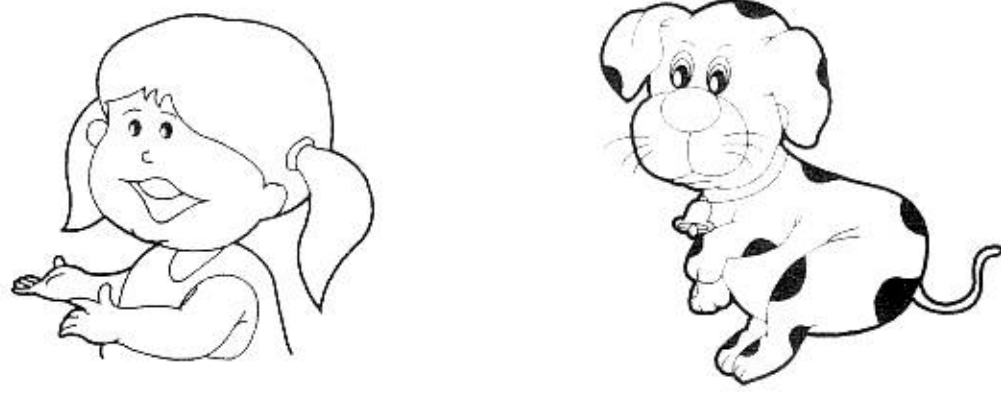
2			

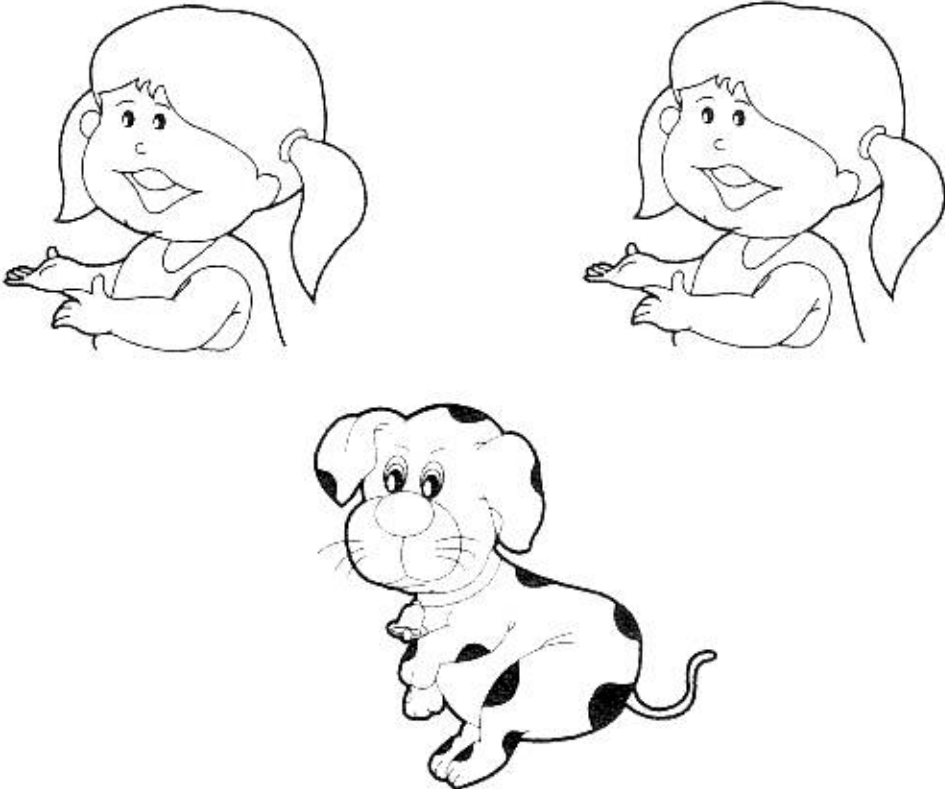
3			

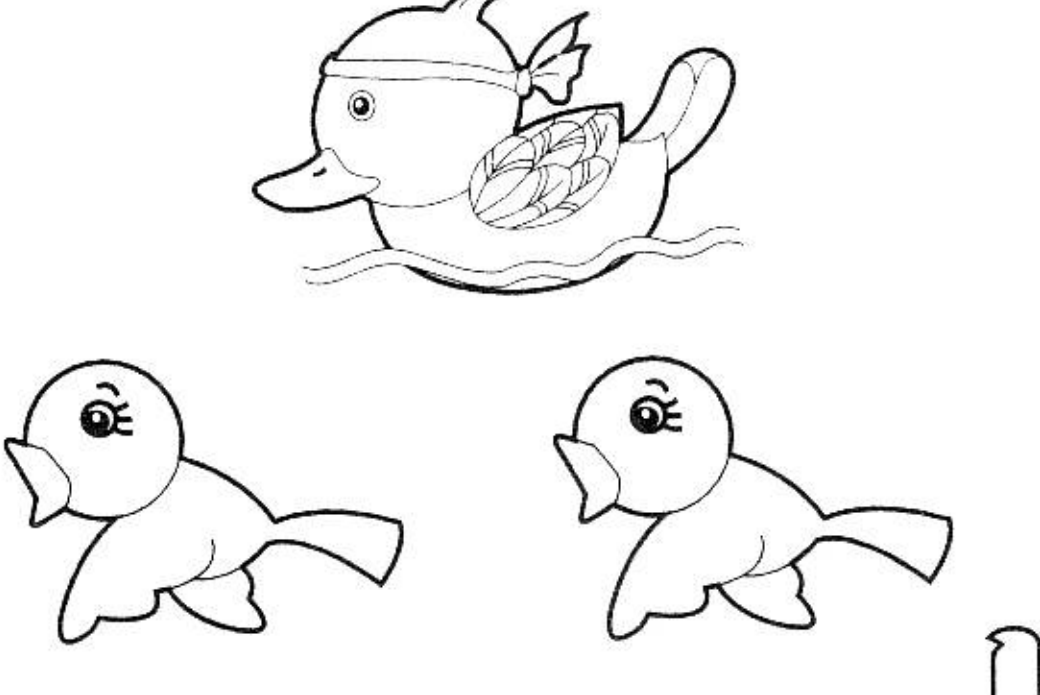
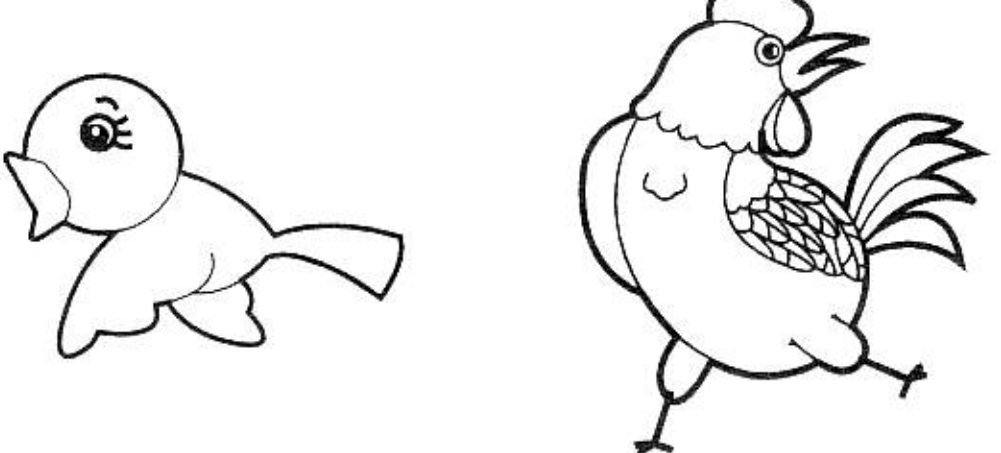

7			
			

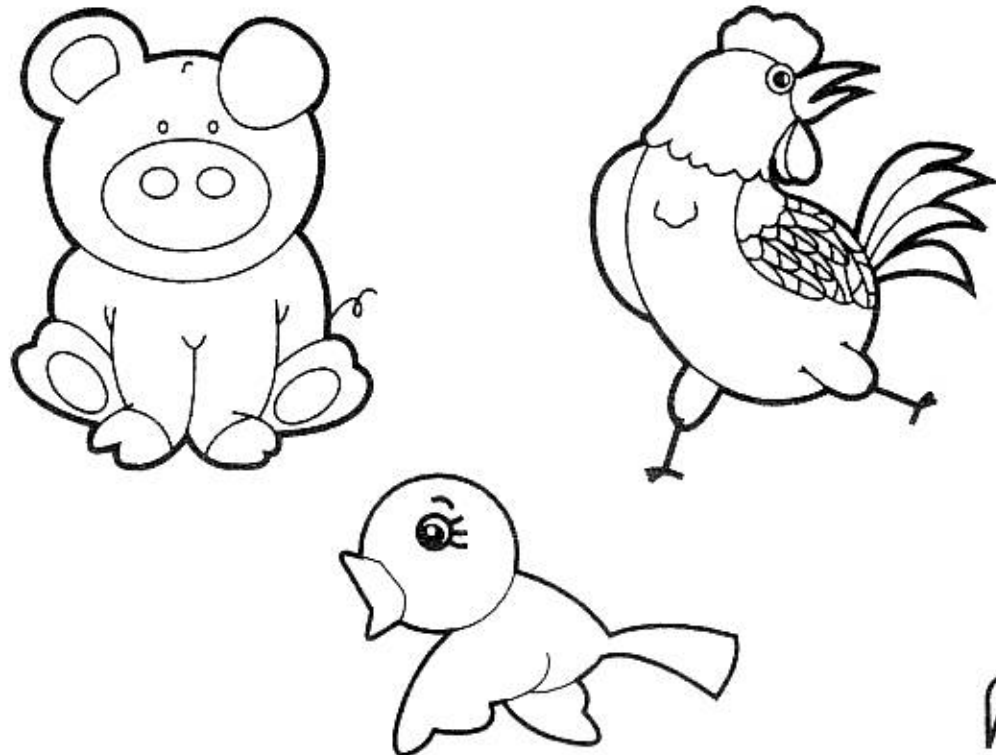
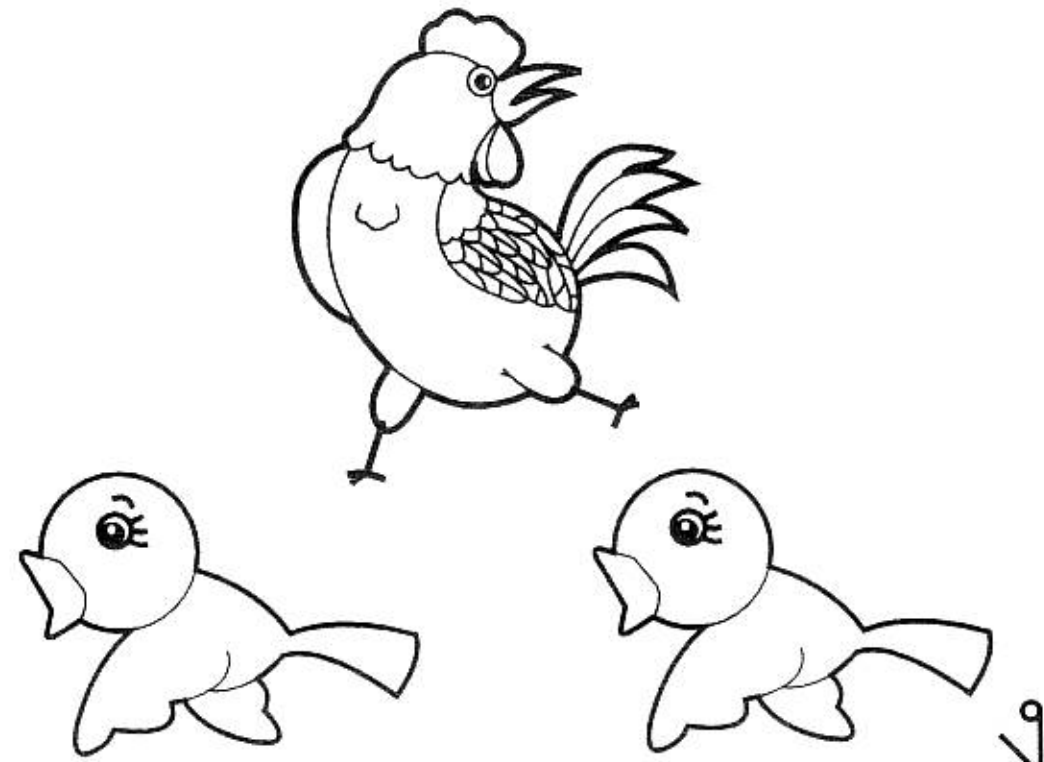
8			
			

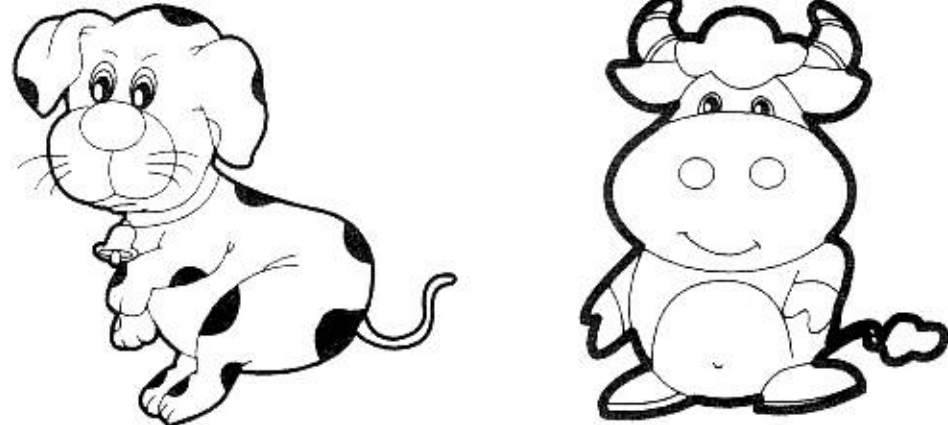
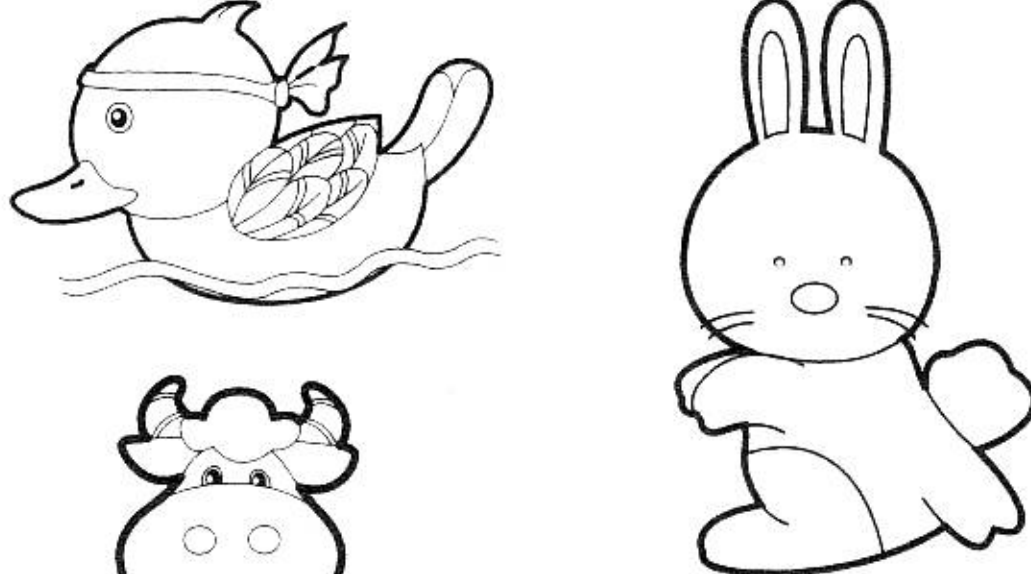
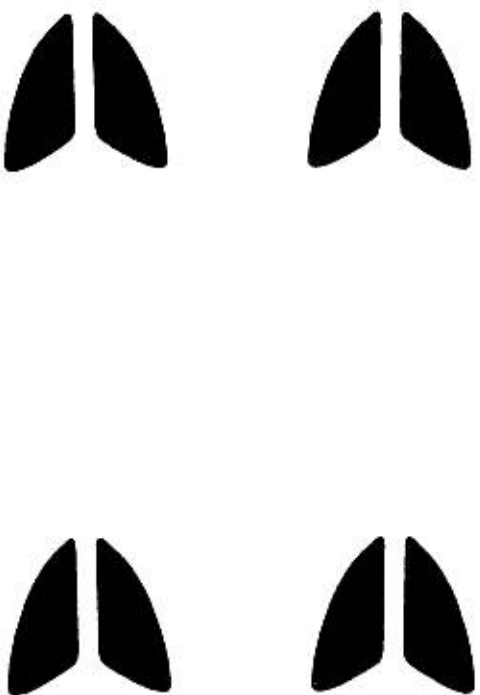
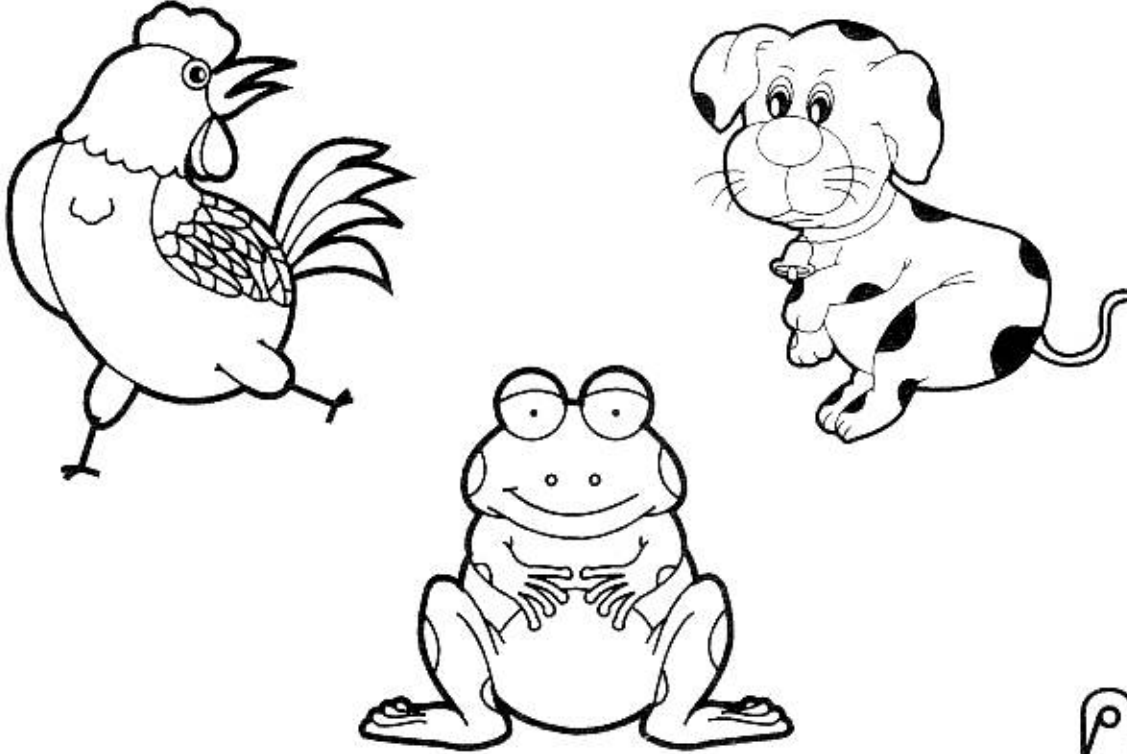
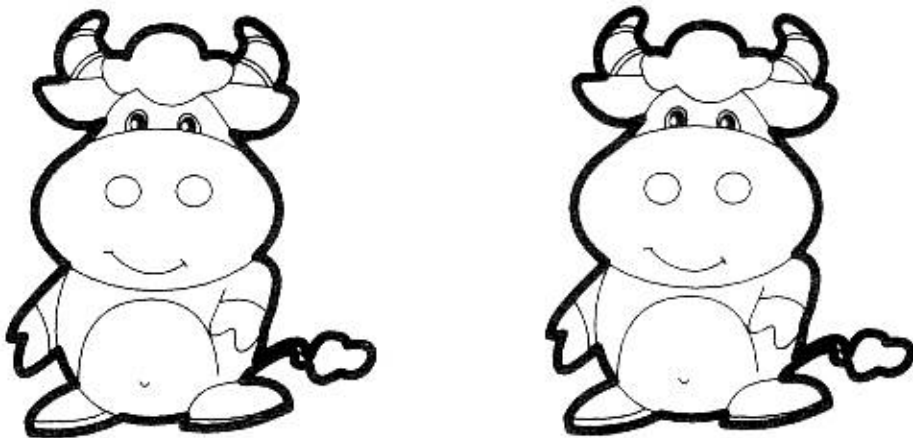
9			
			

10

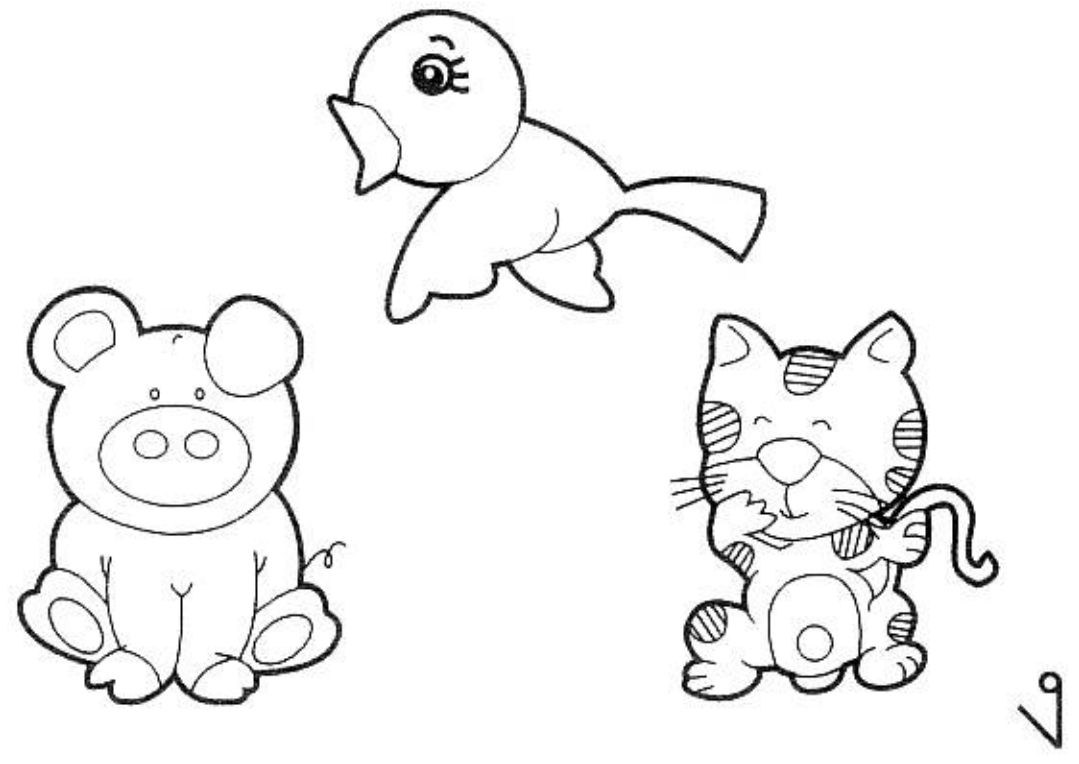
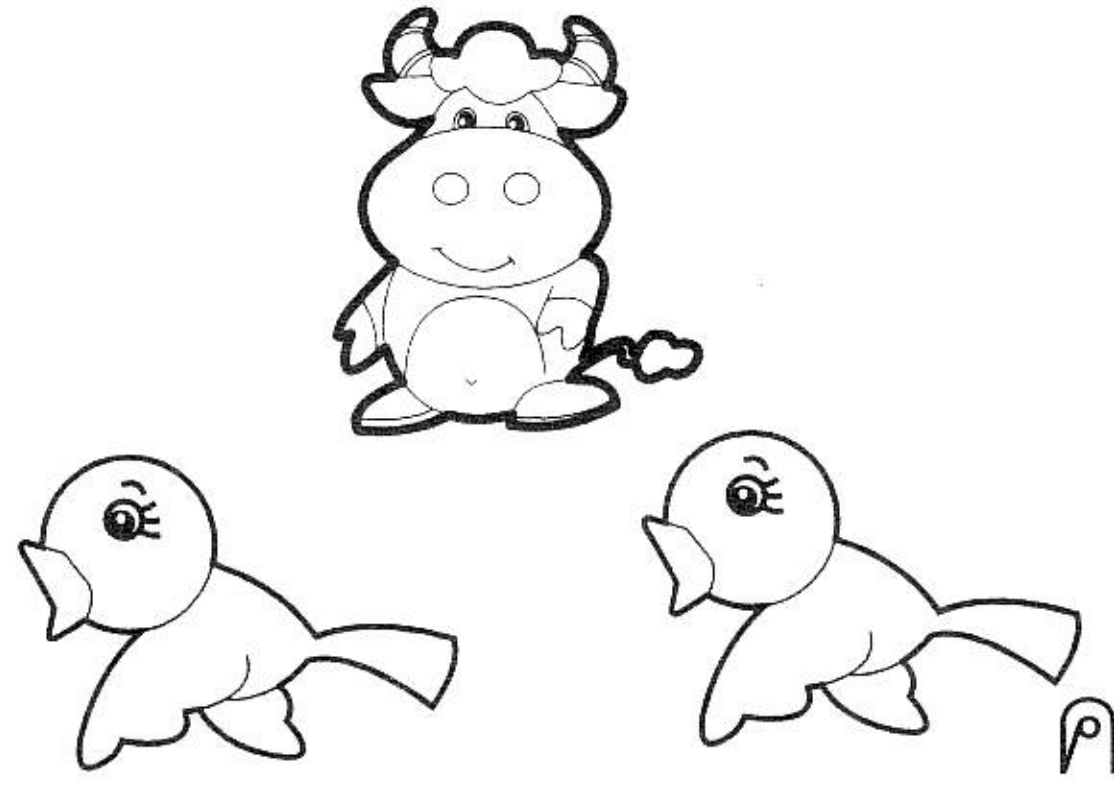
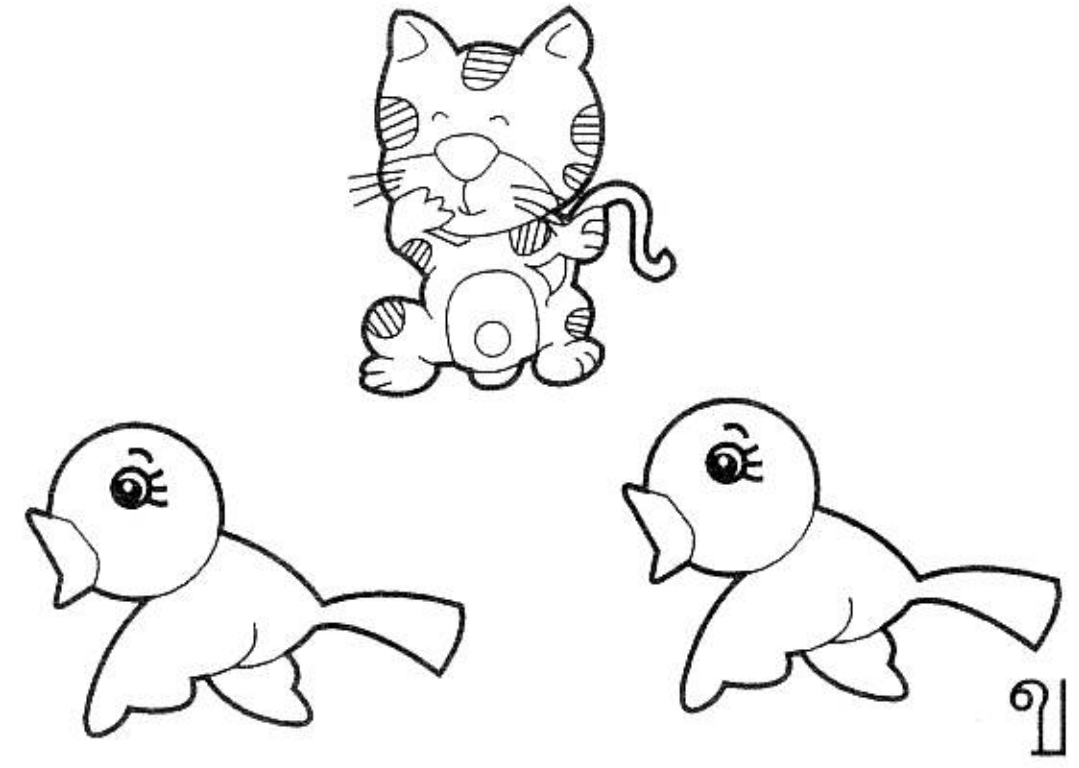
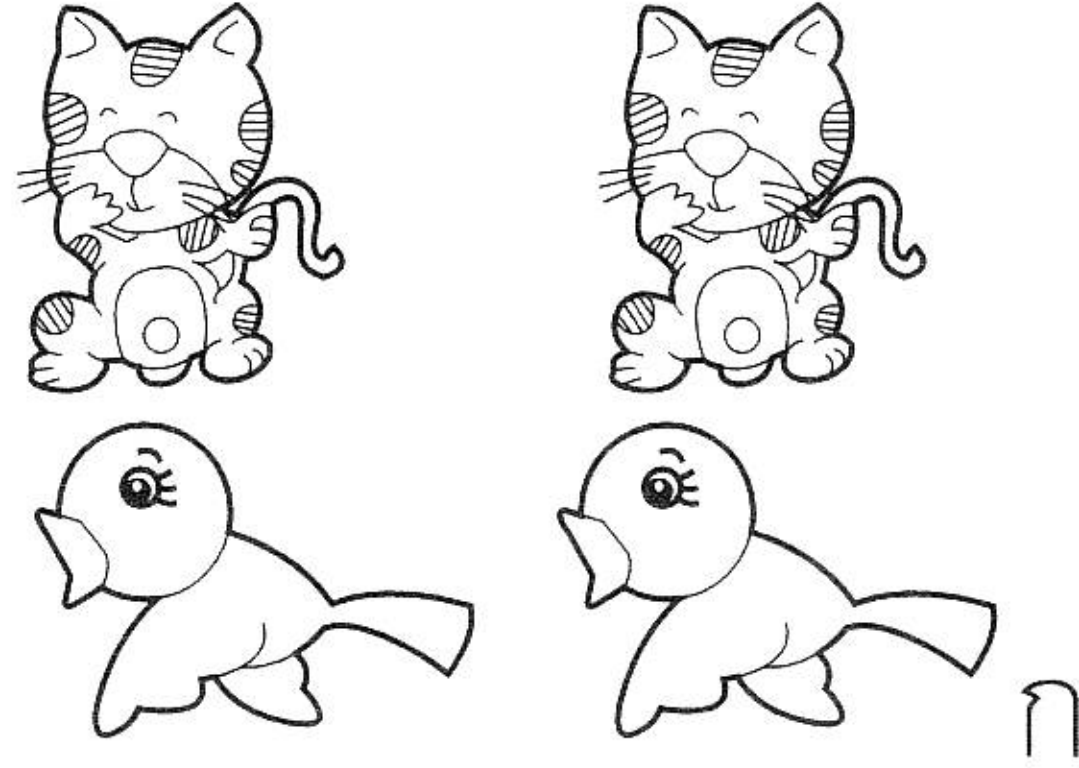
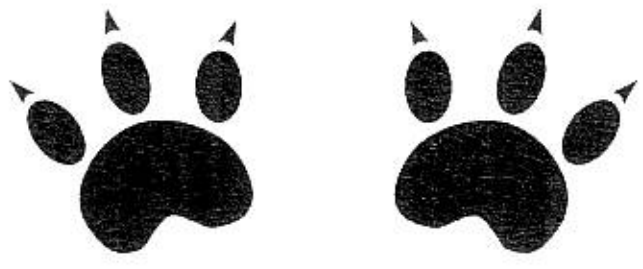
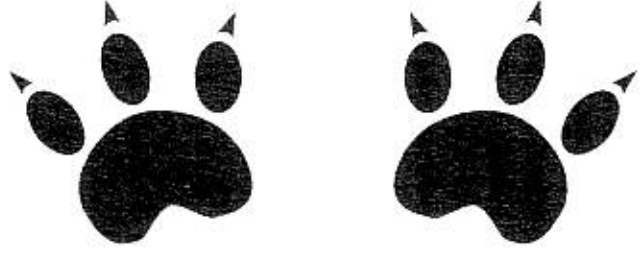

11

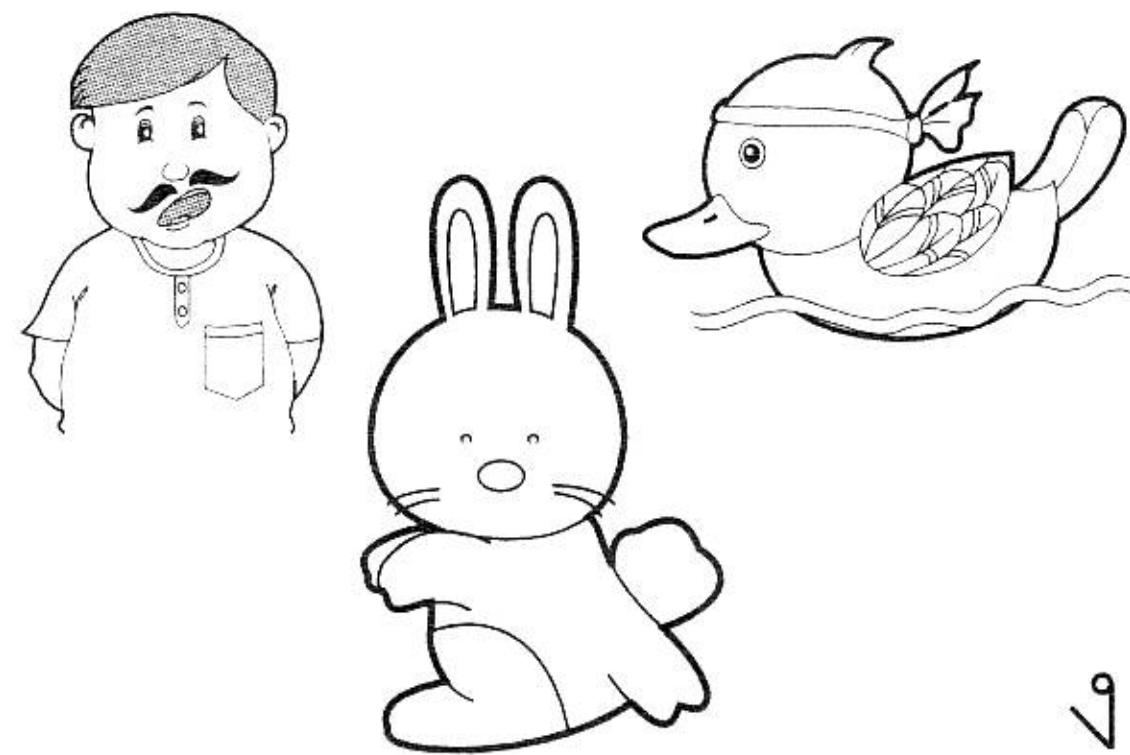
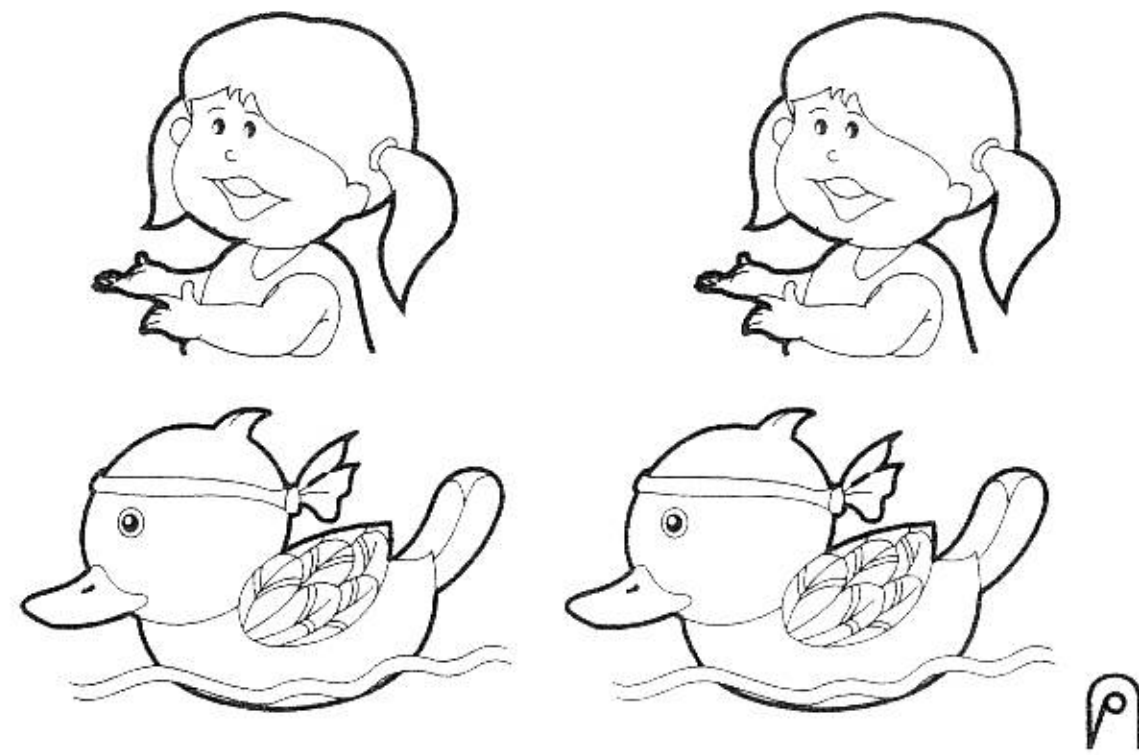
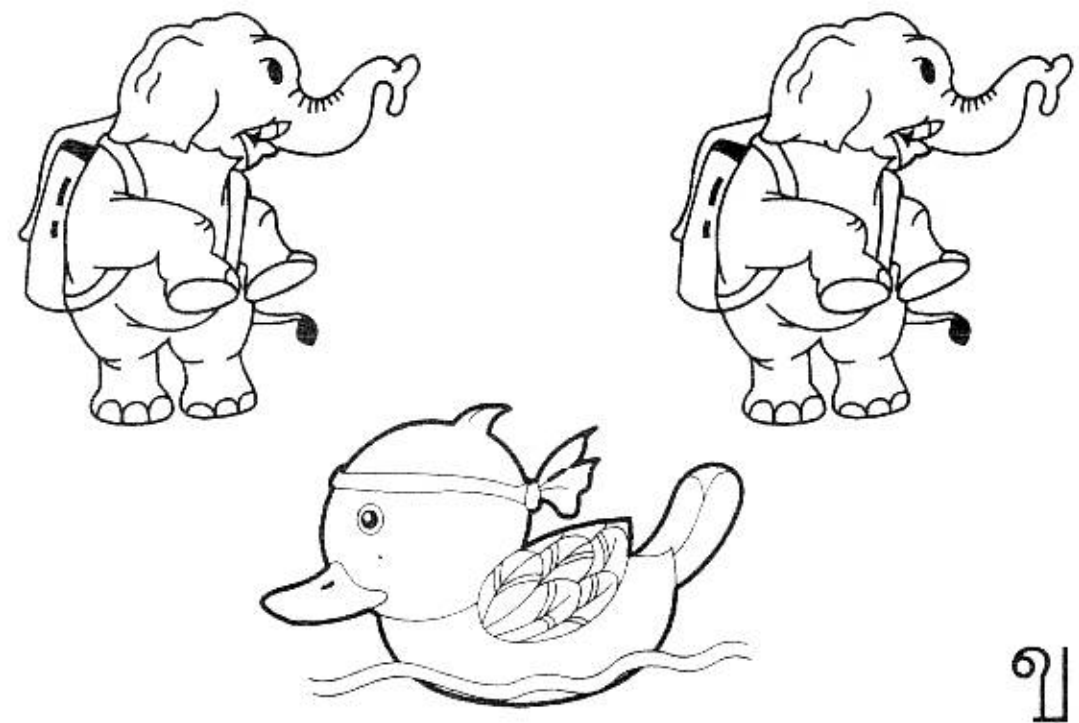

12

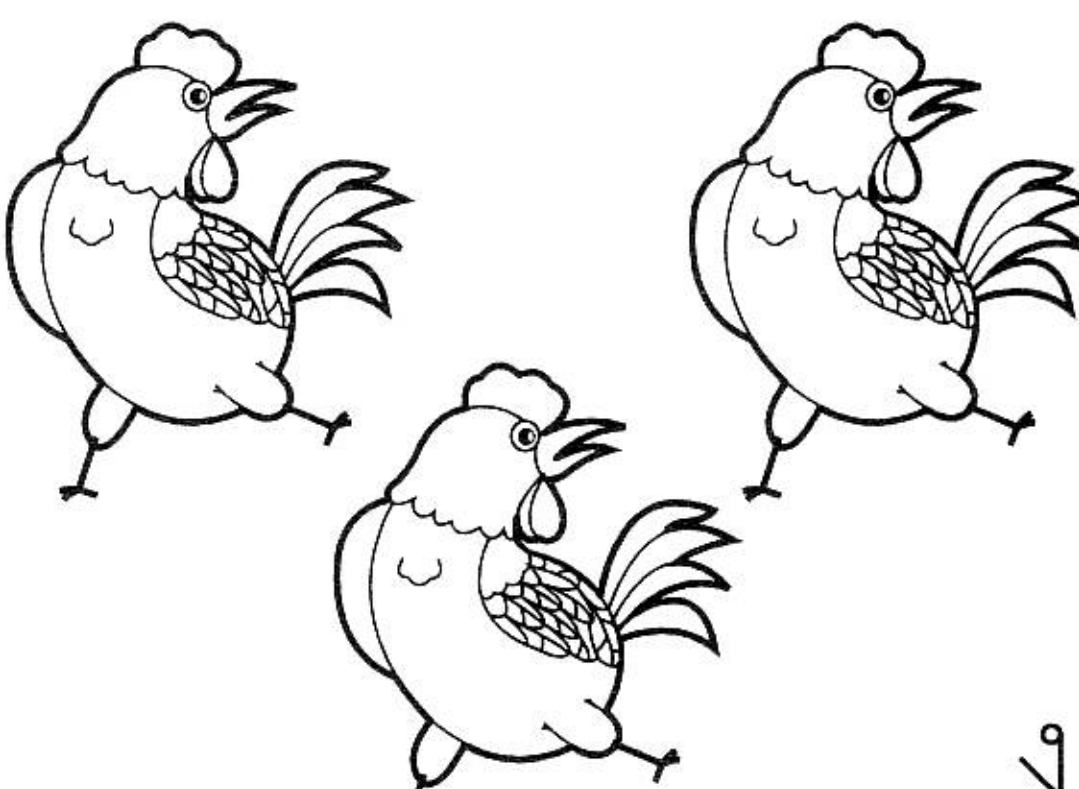
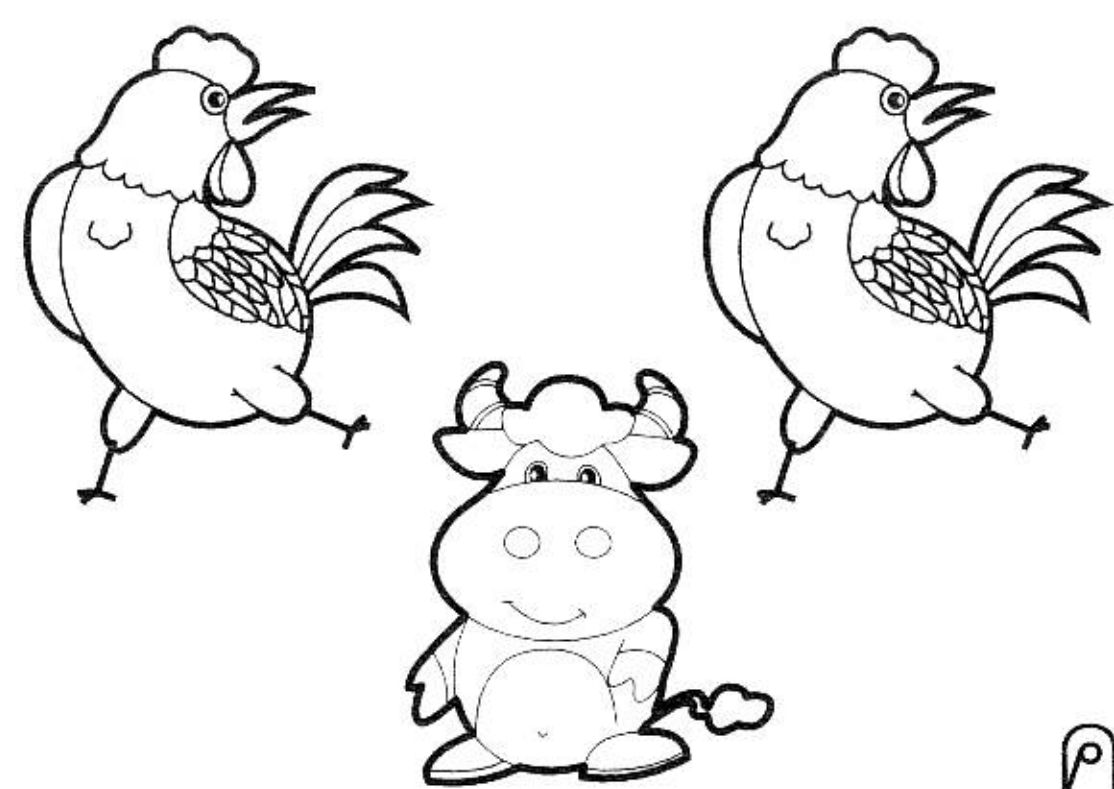
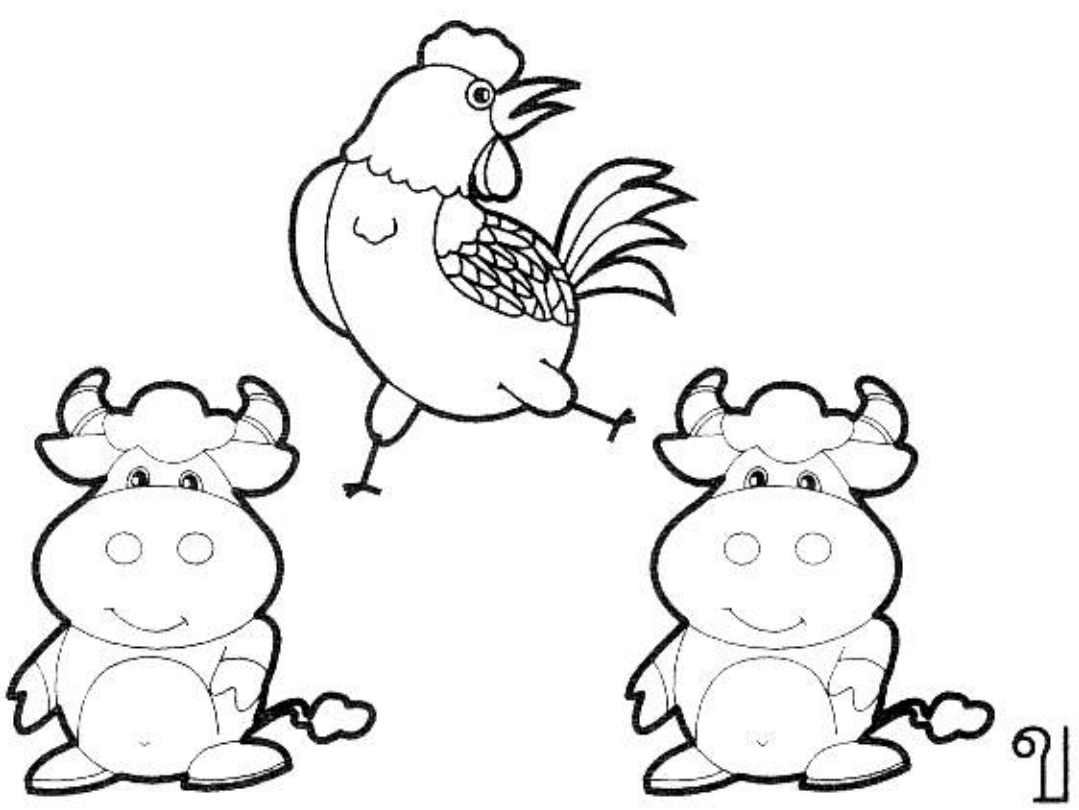

13

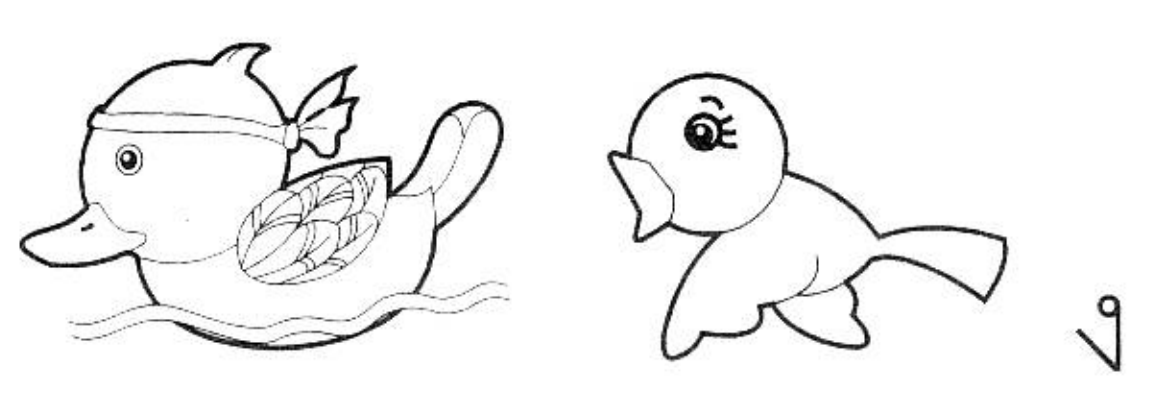
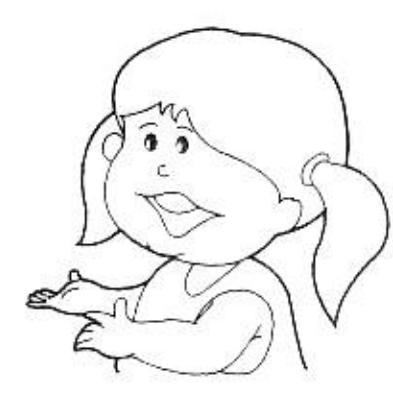
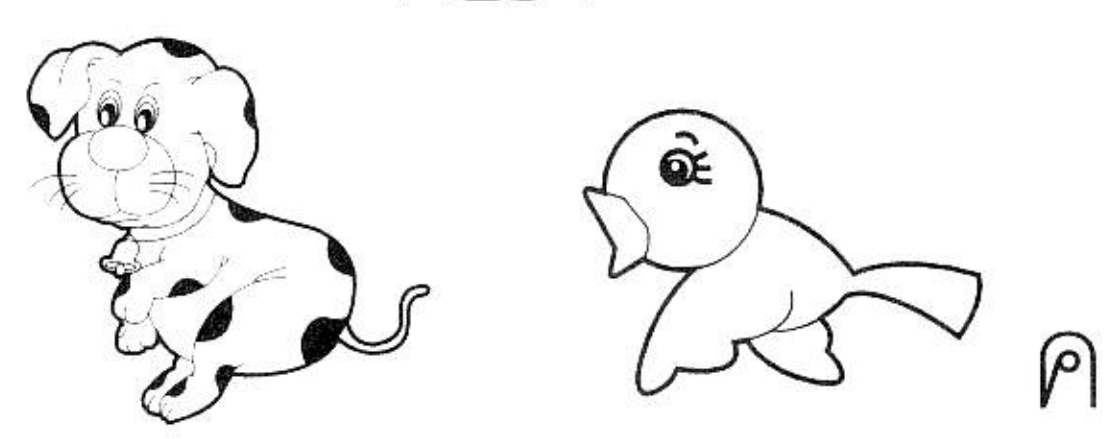
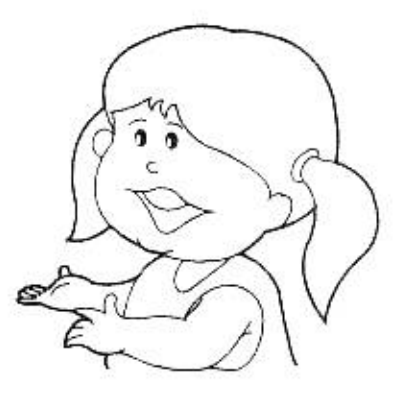
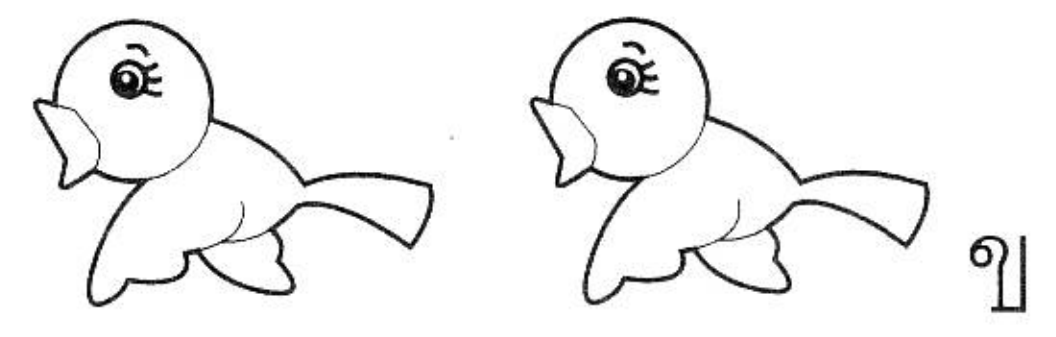
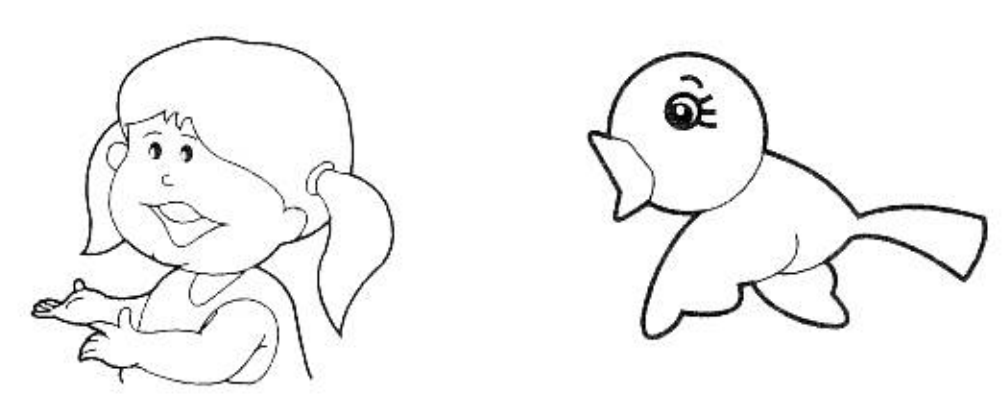
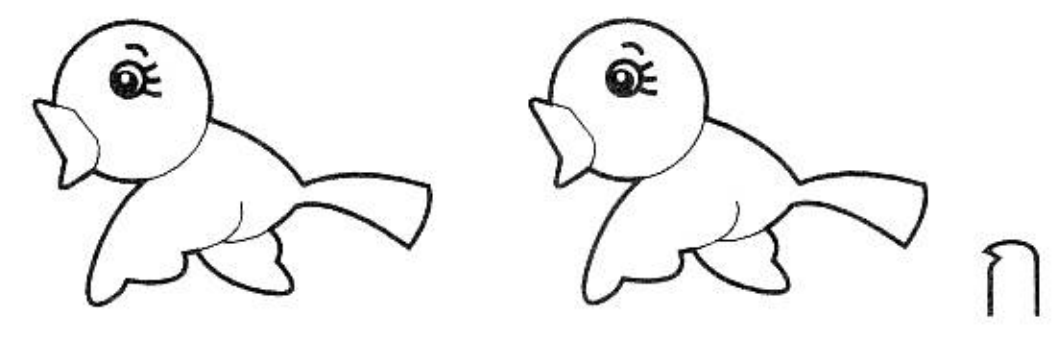
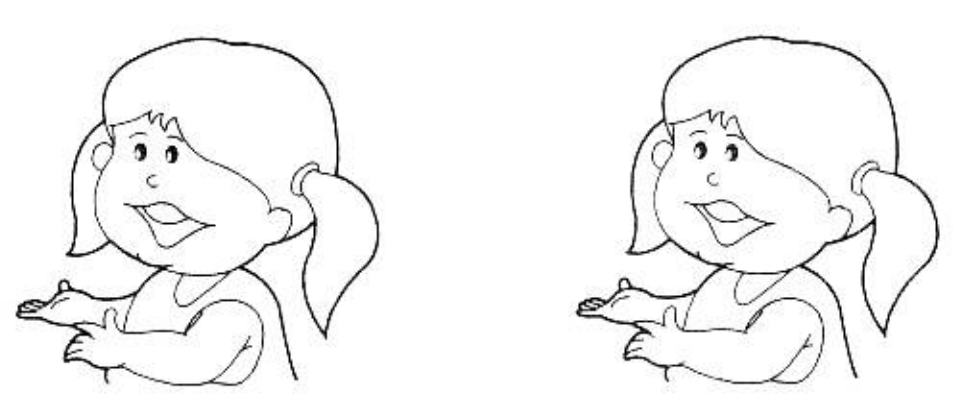
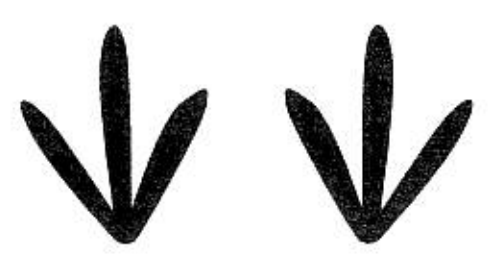
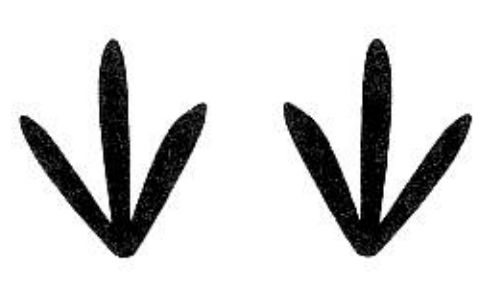

14

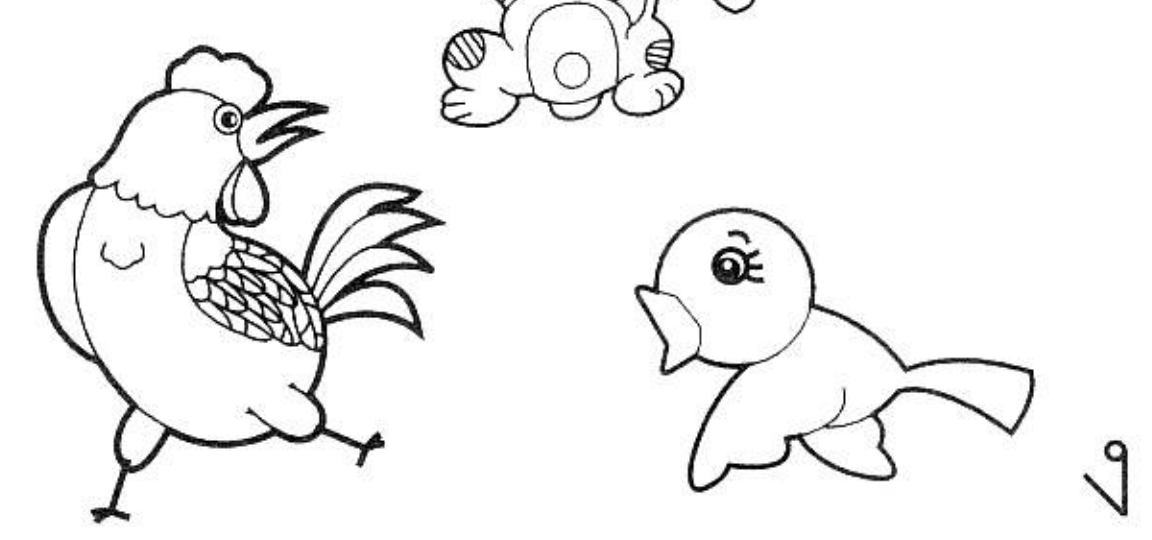
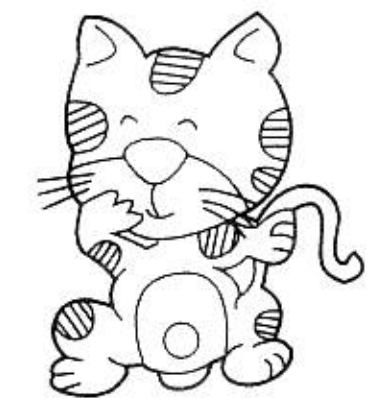
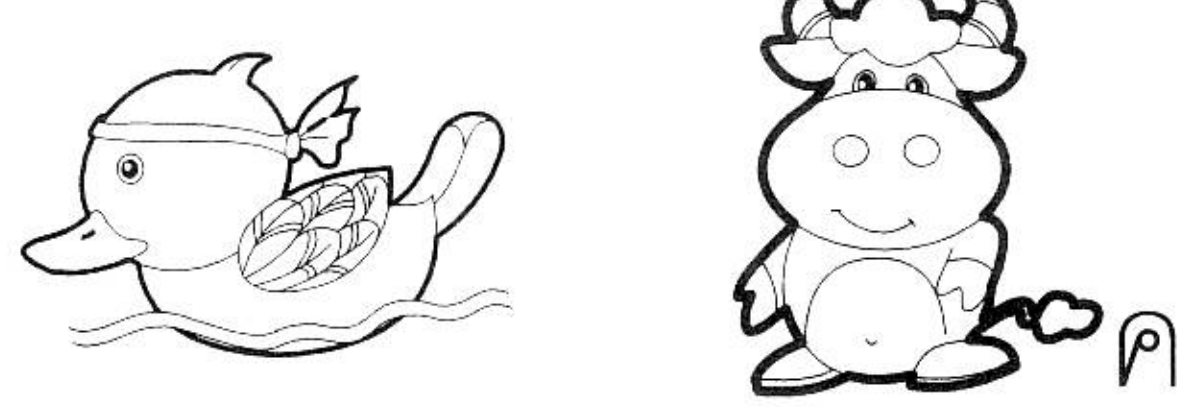
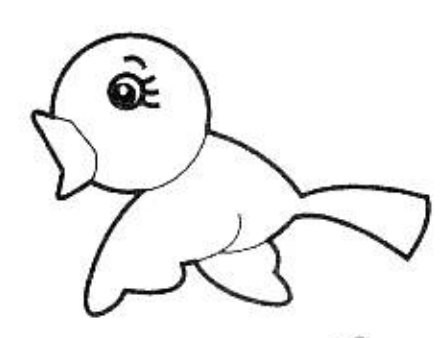
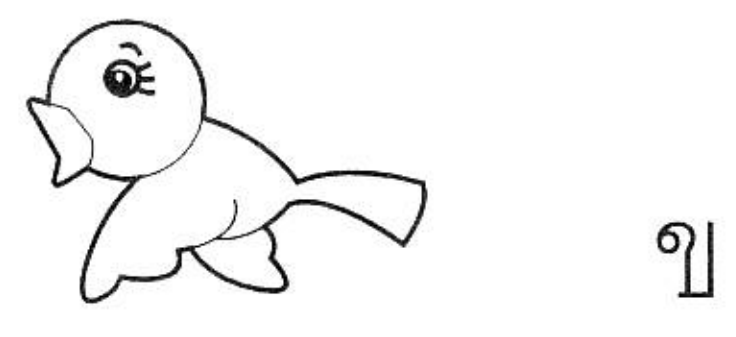
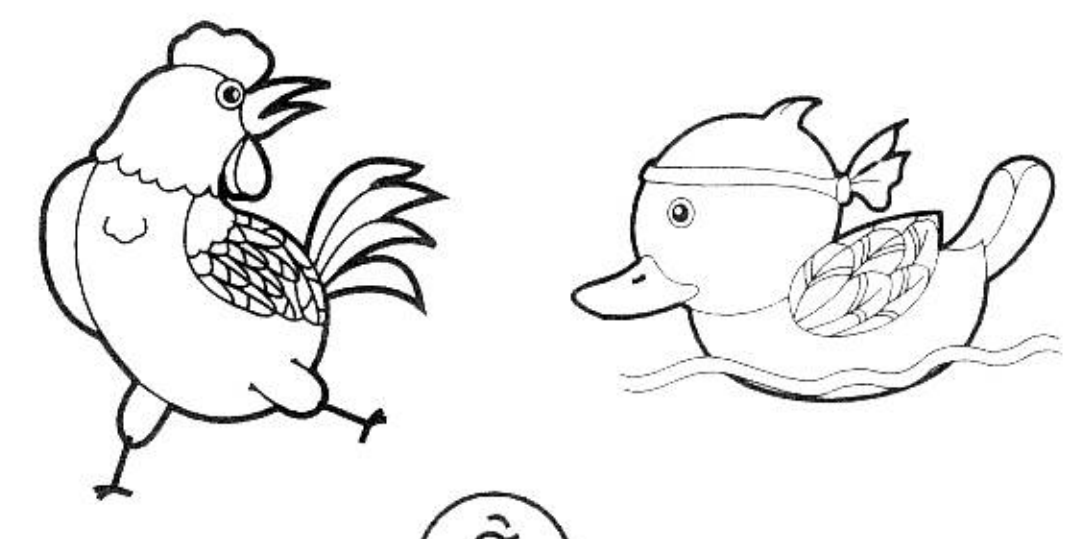
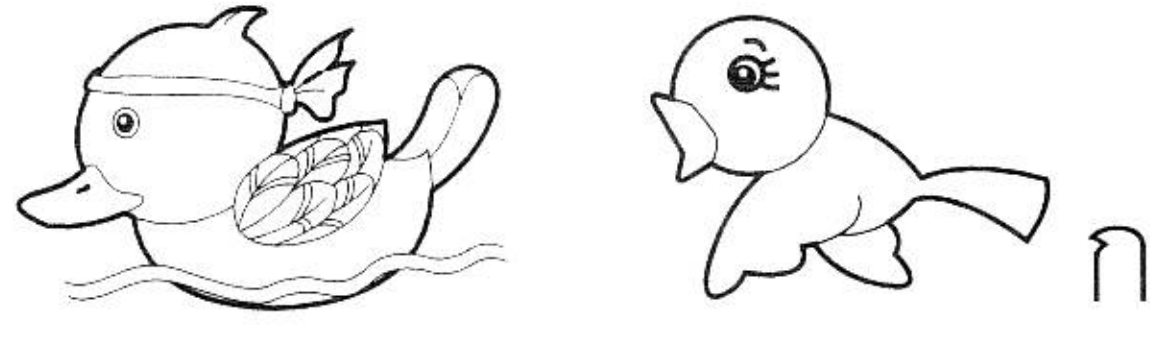
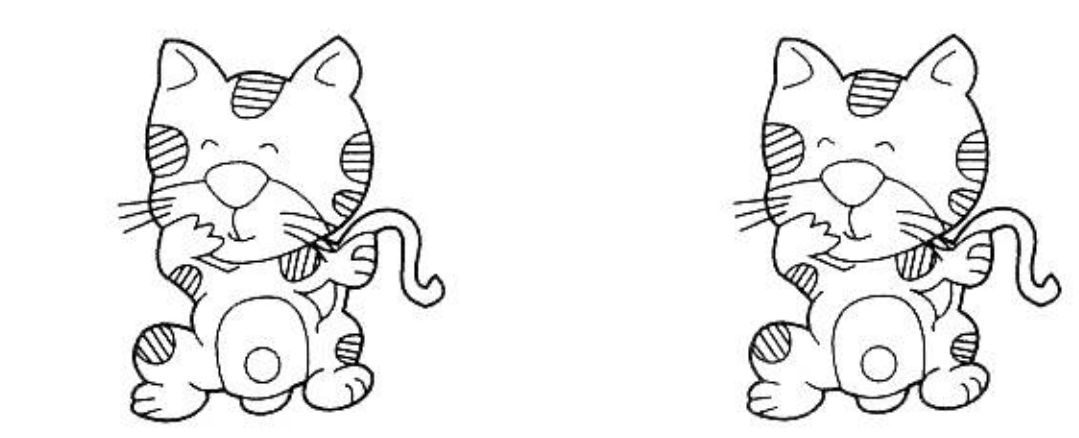
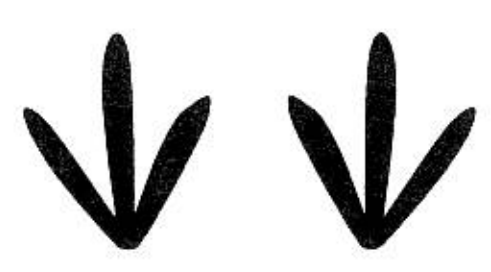
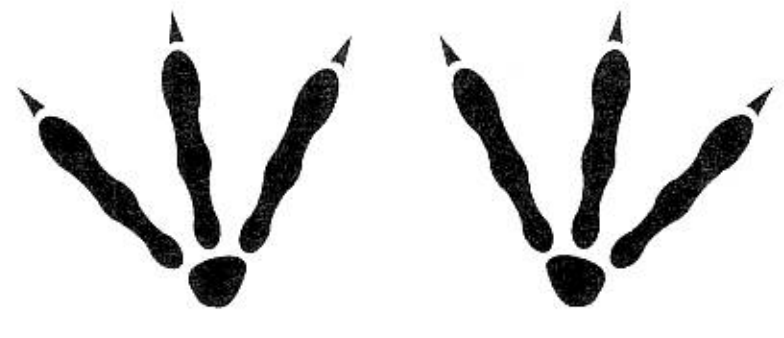
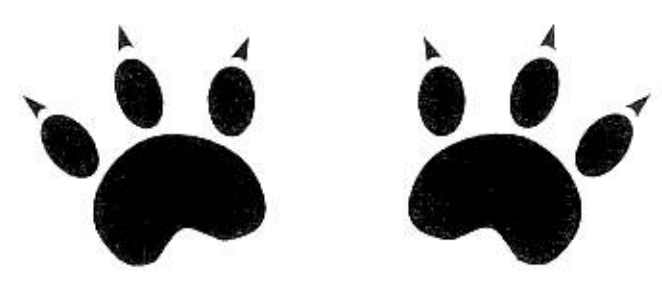
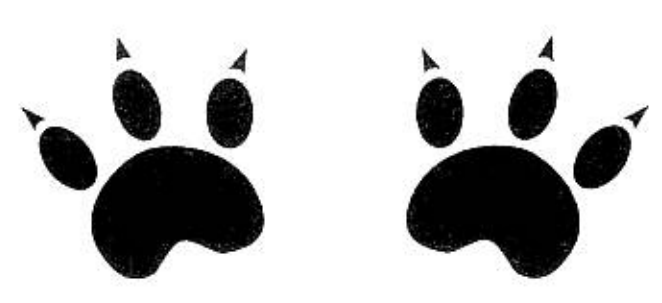

15

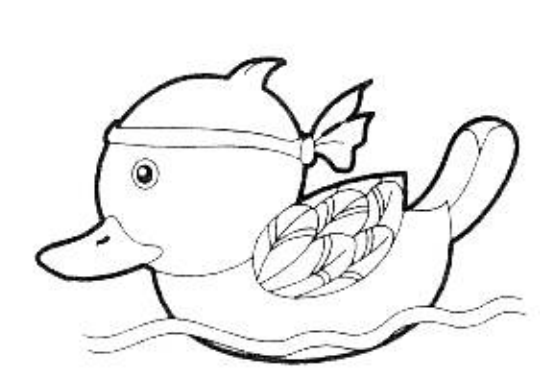
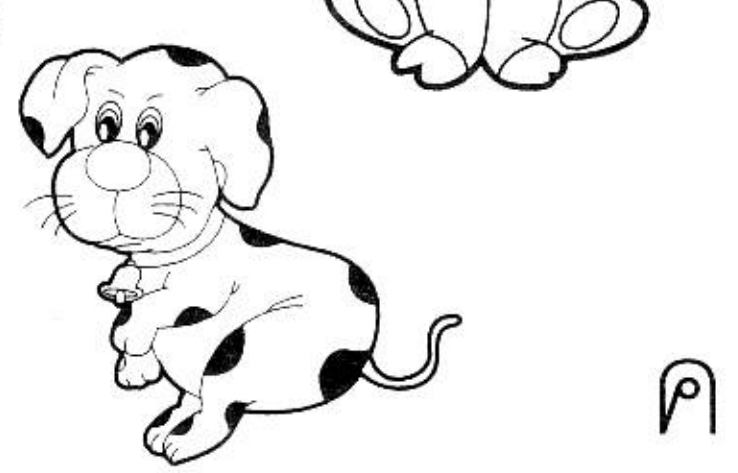
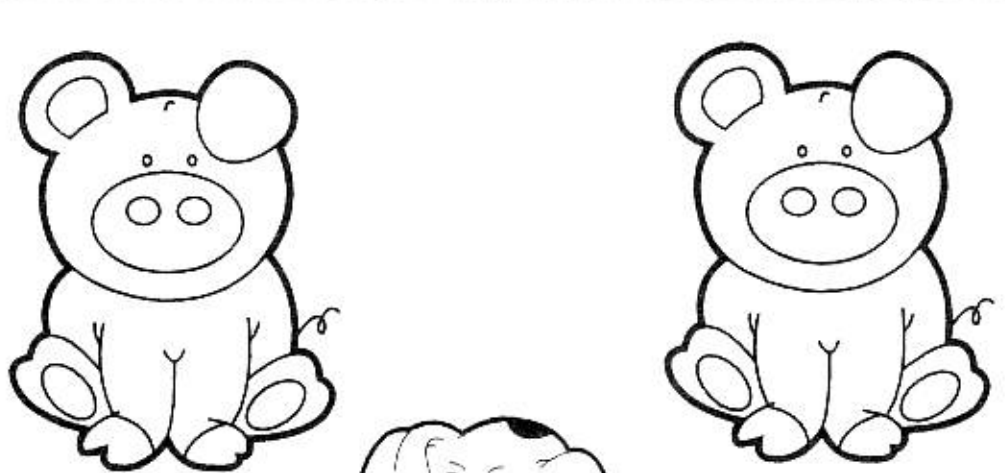
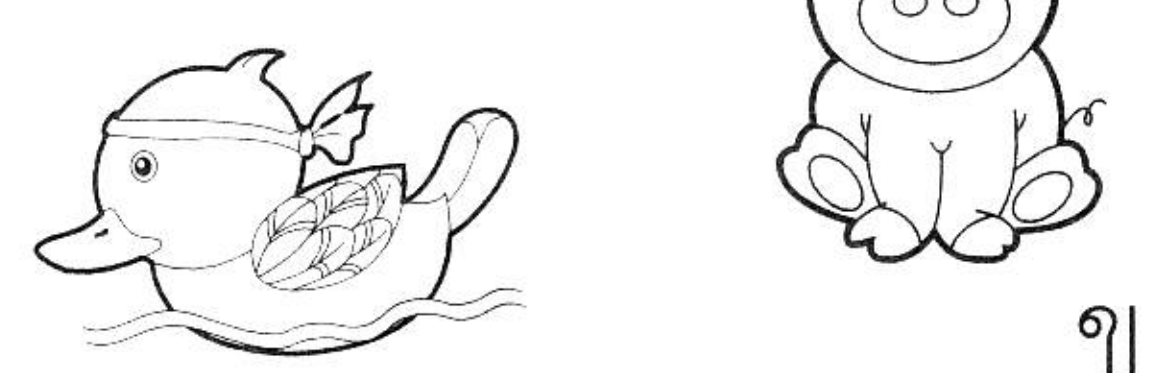
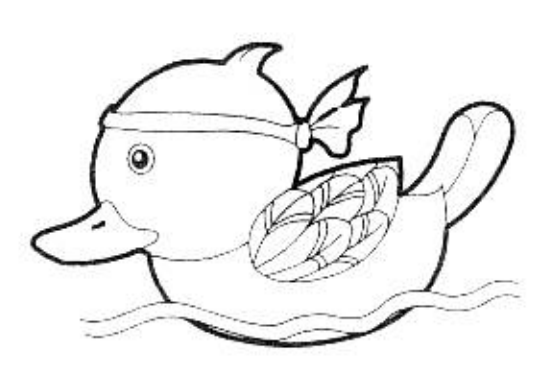
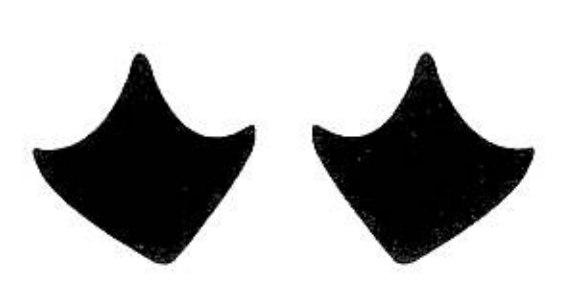

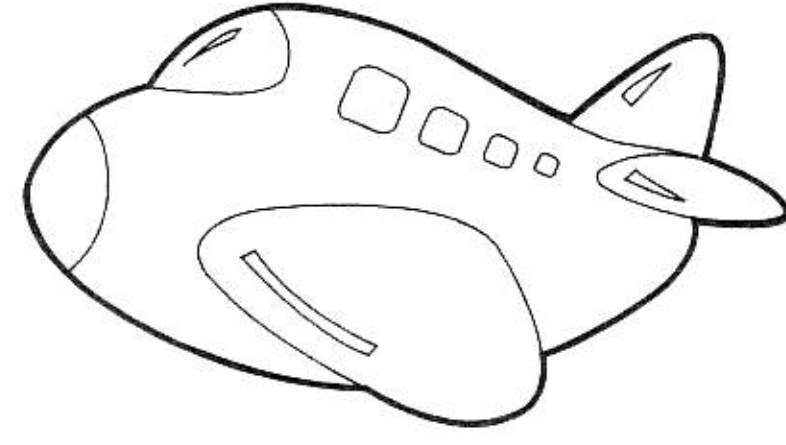

## ตอนที่ 2

### การจัดลำดับภาพต่อเนื่อง

- การหาภาพต่อเนื่อง 20 ข้อ
- โดมิโน 20 ข้อ



จงขีด ✓ ข้อที่มีภาพต่อเนื่องที่นำมาเติมในช่องว่างได้

1

1

△ △ □ □ △ △ △ □ — —

□ △ □ □ □ □ □ □

ก ข ค ง

2

2

↑ ↑ ↓ → → ← ↓ — —

↑ ↓ ↑ ↑ ↓ ↑ ↓ ↓

ก ข ค ง

3

3

● ○ ○ □ □ ■ ● ○ — — —

○ □ ■ ● □ □ ○ □ □

ก ข ค ง

4

4

○ ● ○ ● ○ ● ○ ● ○ ● ○ ● ○ ● ○ ● — — —

○ ● ○ ● ○ ● ○ ● ○ ● ○ ●

ก ข ค ง

5

1 2 3 3 4 5 5 \_ \_ \_

6 7 7 6 7 7 6 7 7 6 7 8

ก

ข

ค

ง

6

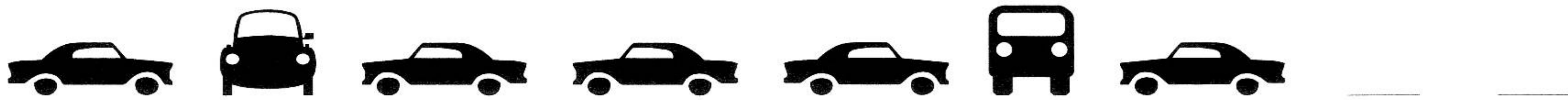

ก

ข

ค

ง

7

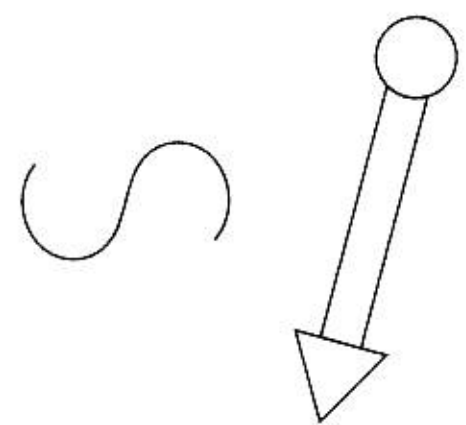
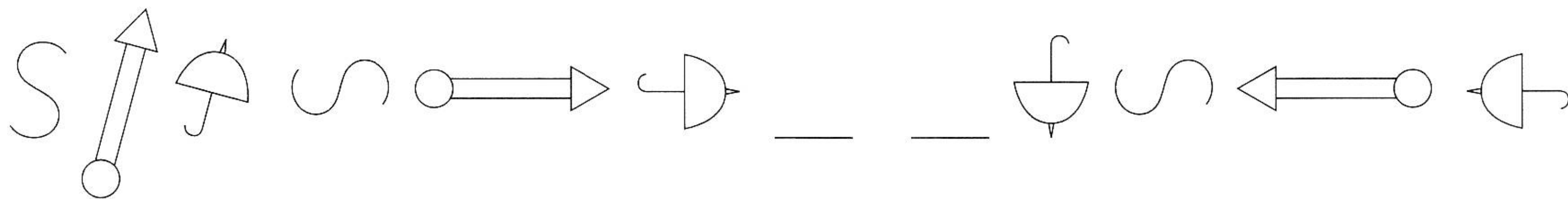

ก

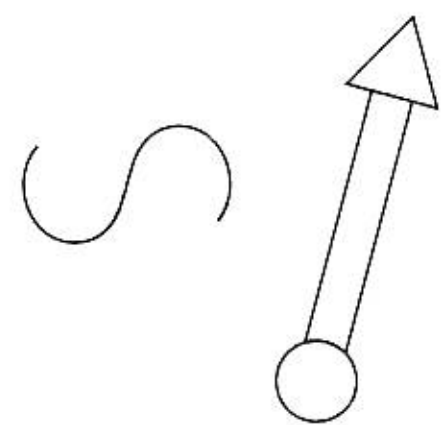

ข

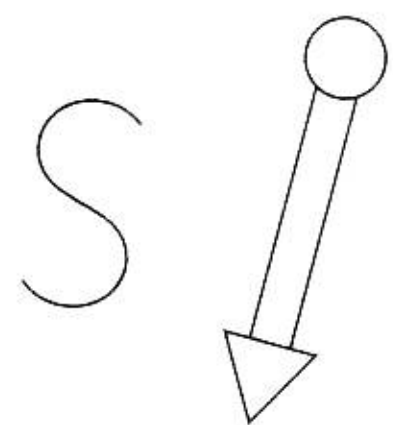

ค

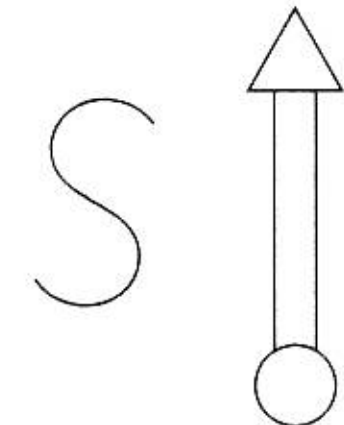

ง

8

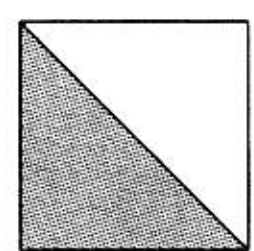
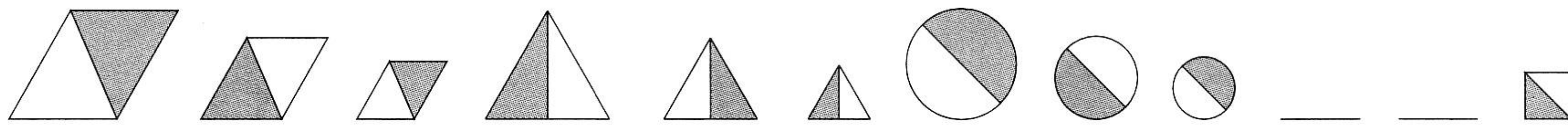

ก

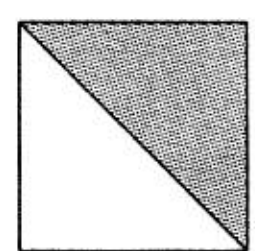
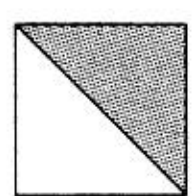

ข

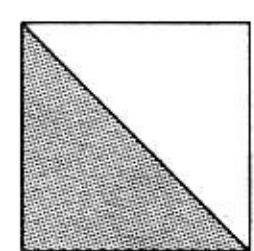
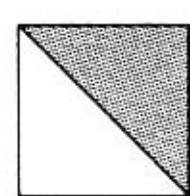

ค

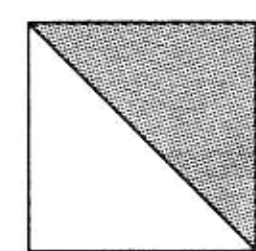
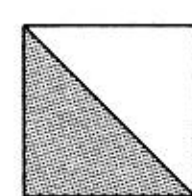

ง

9

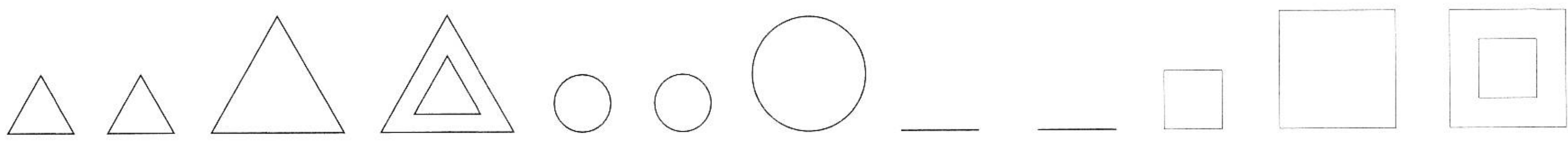

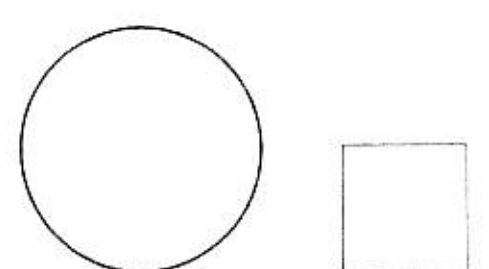
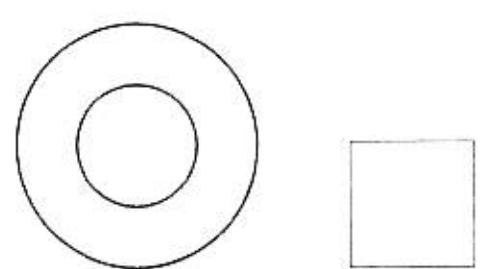
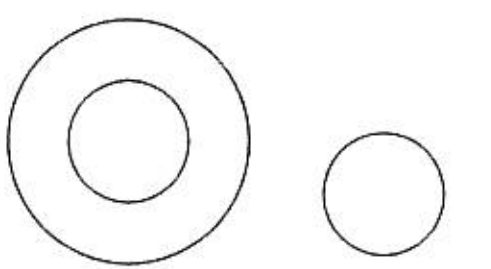
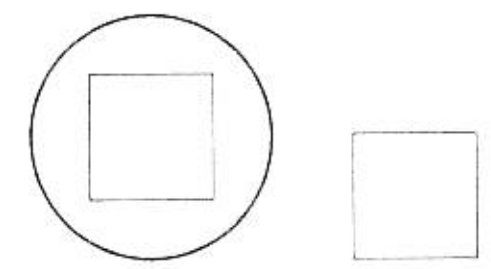

ก                      ข                      ค                      ง

10

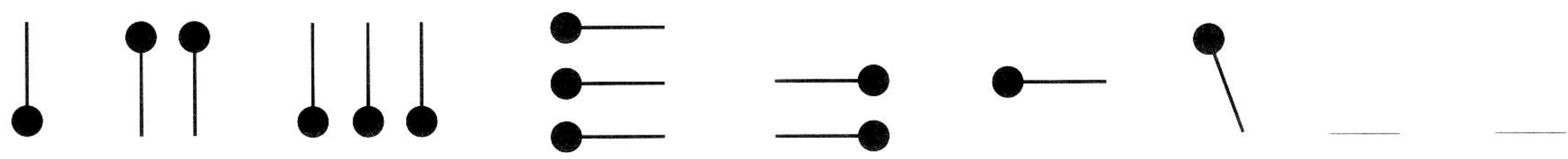

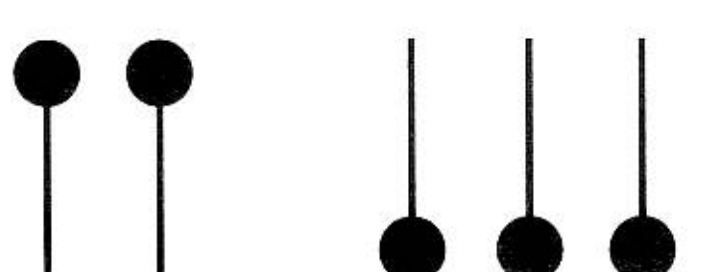
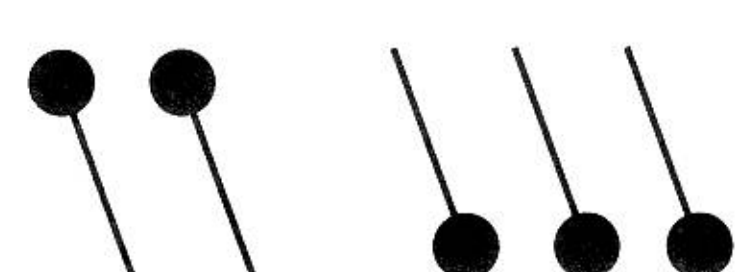

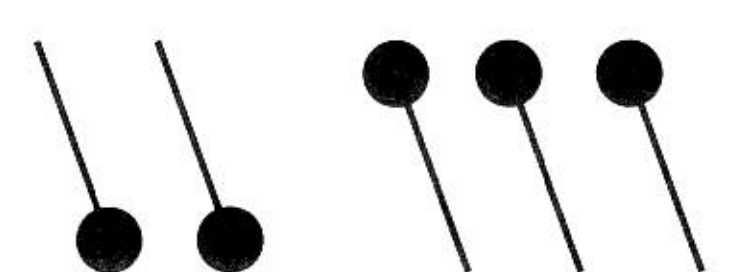
ก                      ข                      ค                      ง

11

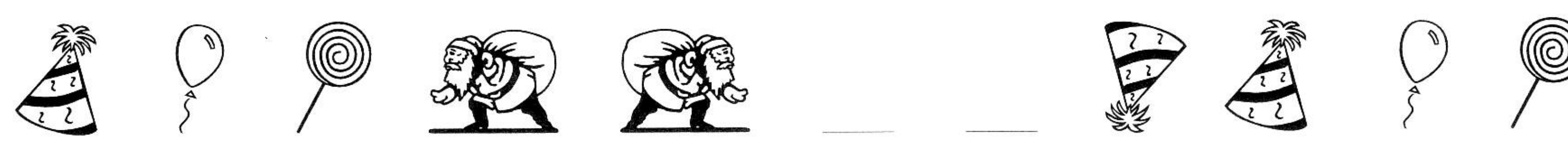

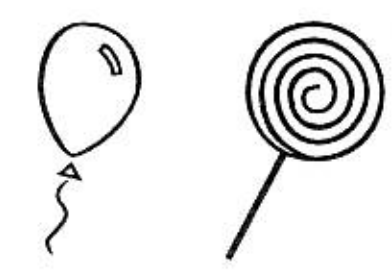

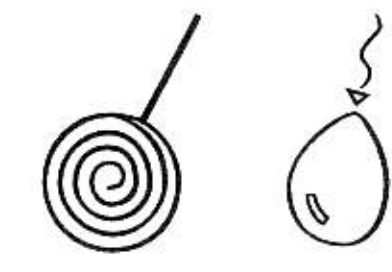
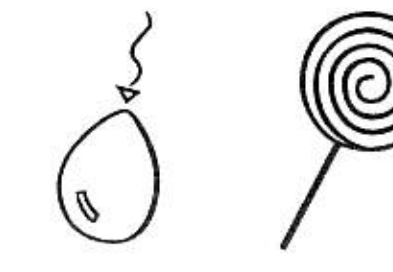

ก                      ข                      ค                      ง

12



ก                      ข                      ค                      ง

13

၁                      ၂                      ၃                      ၄

14

၁                      ၂                      ၃                      ၄

15

၁                      ၂                      ၃                      ၄

16

၁                      ၂                      ၃                      ၄

17

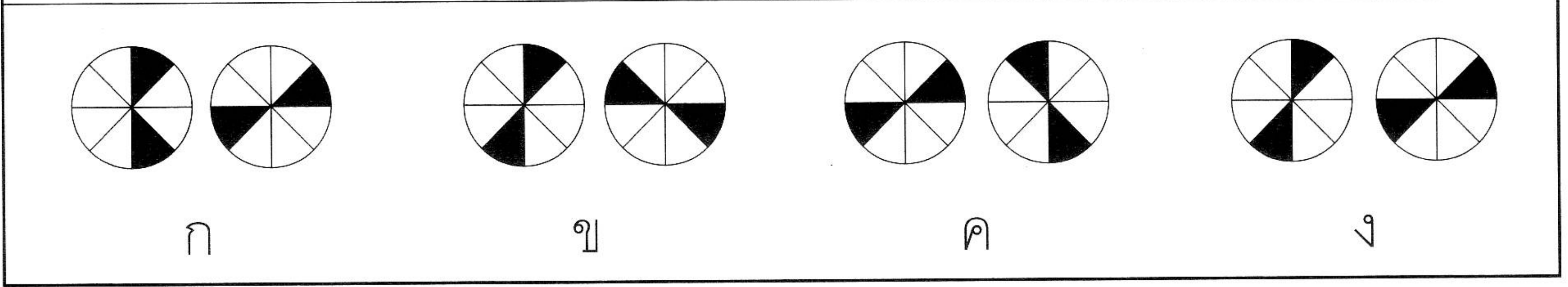
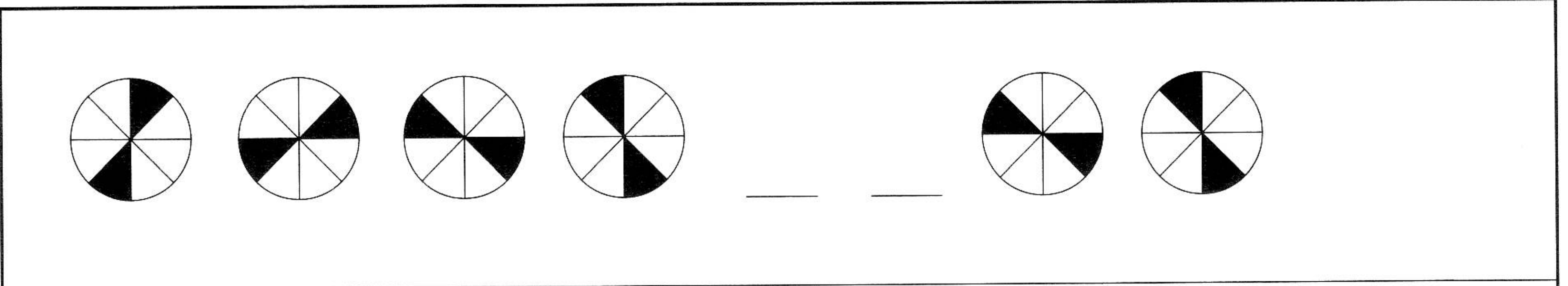

18

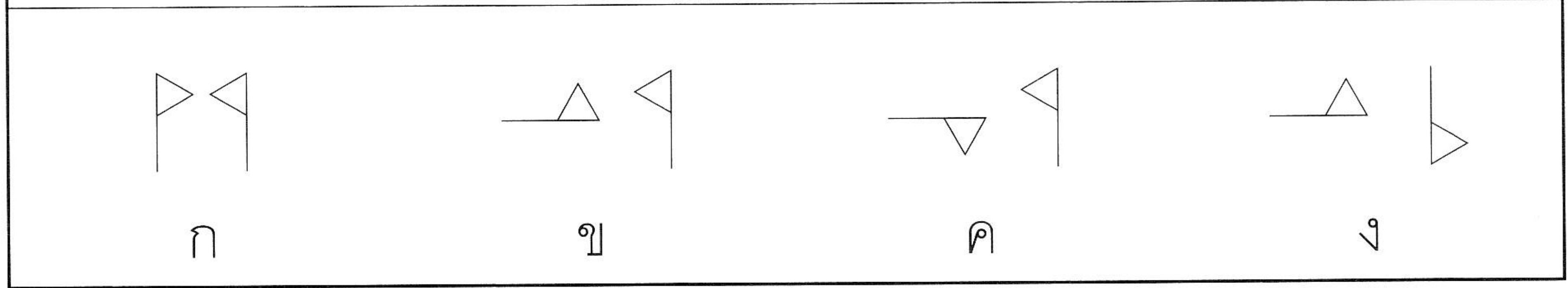
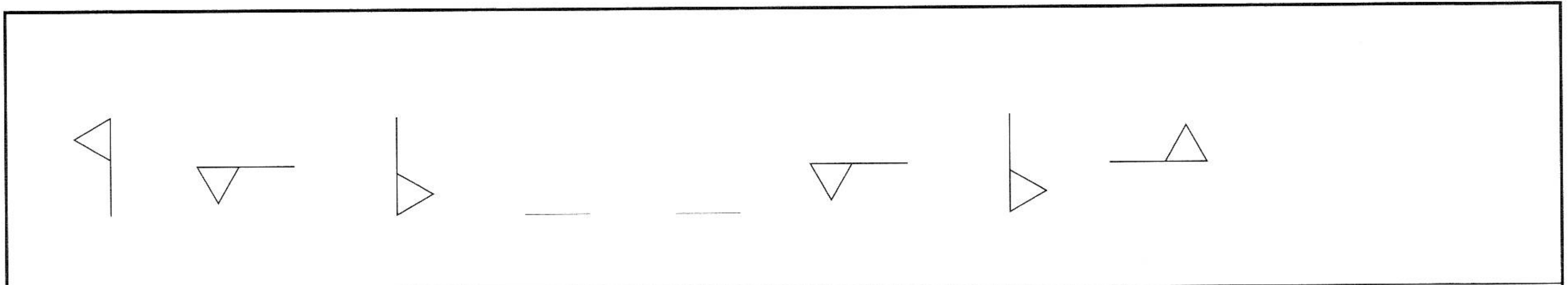

19

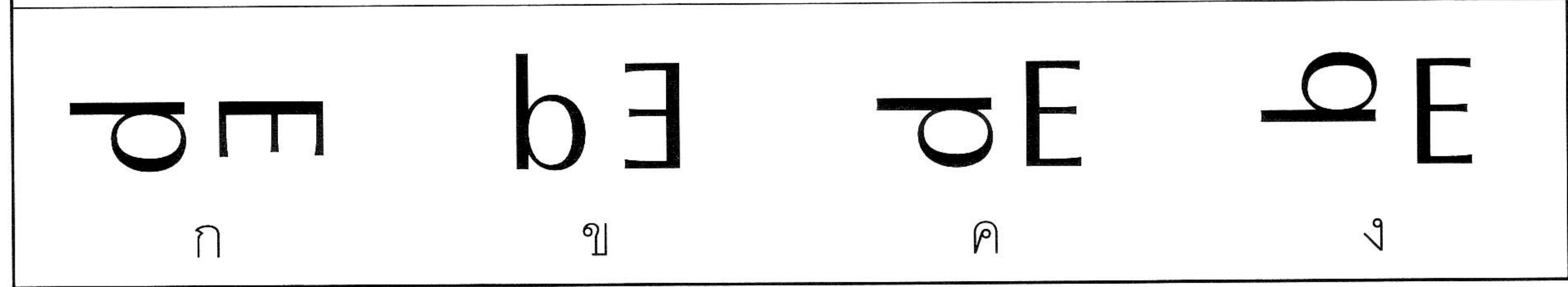
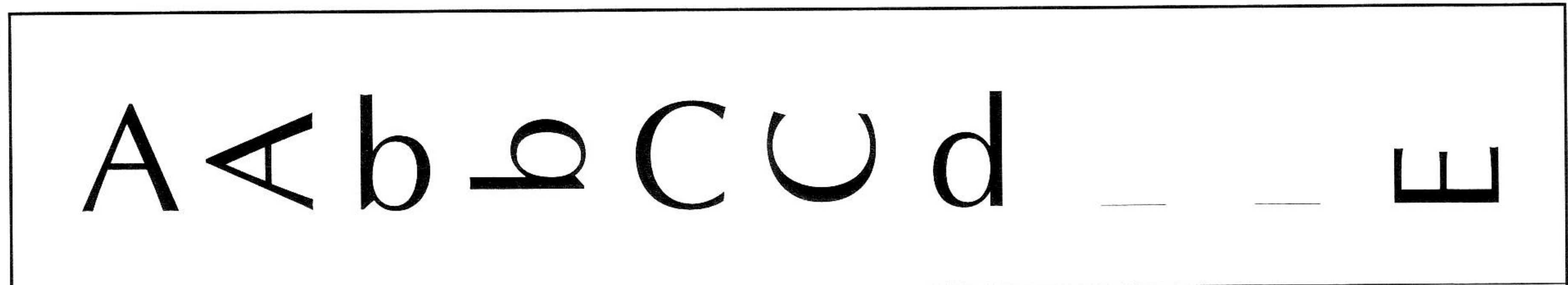

20

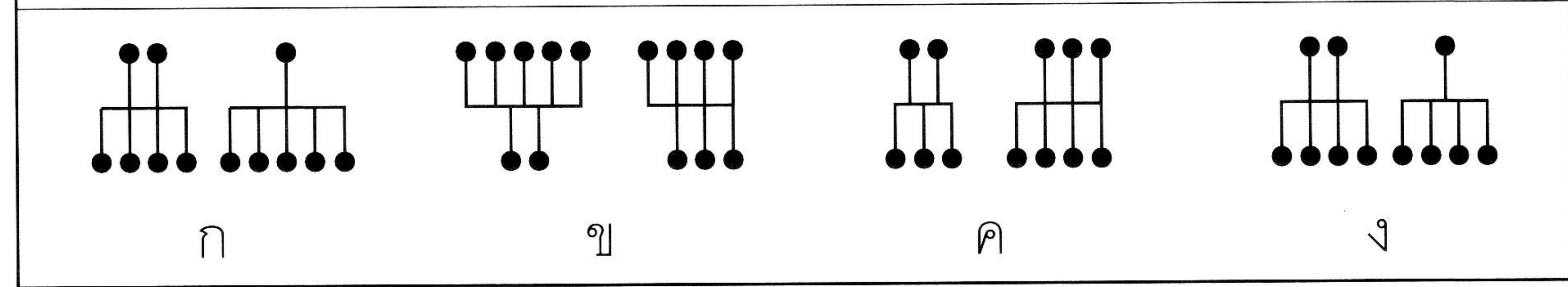
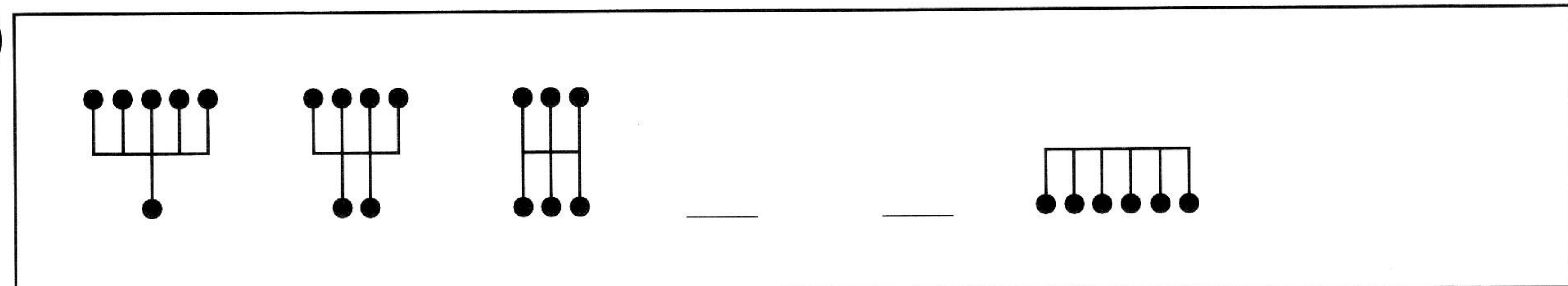

จงเติมจุดในรูป   ให้ถูกต้อง

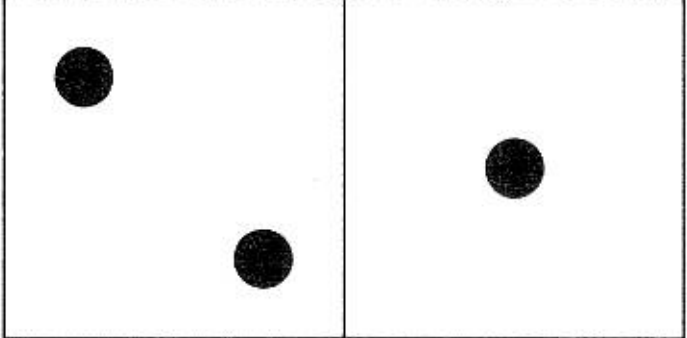
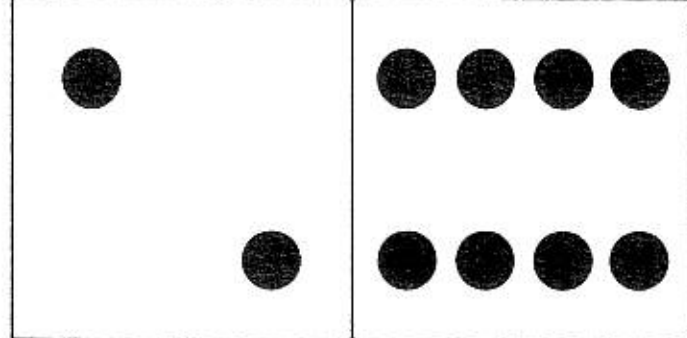
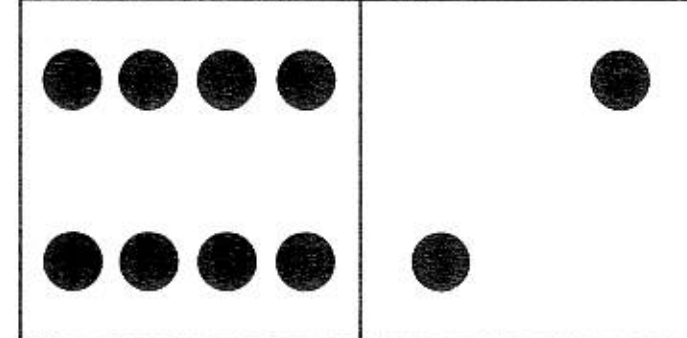
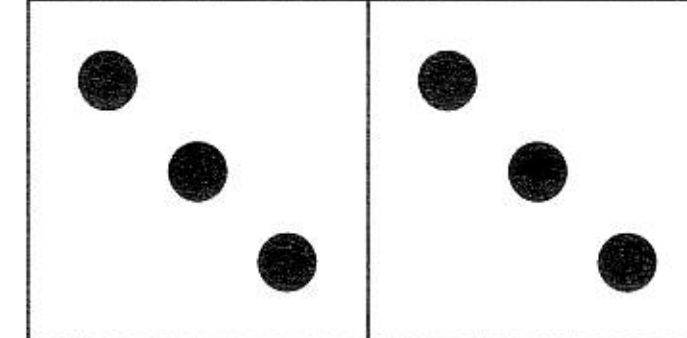
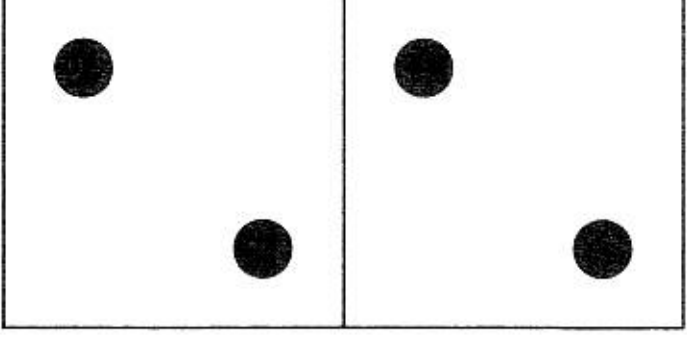
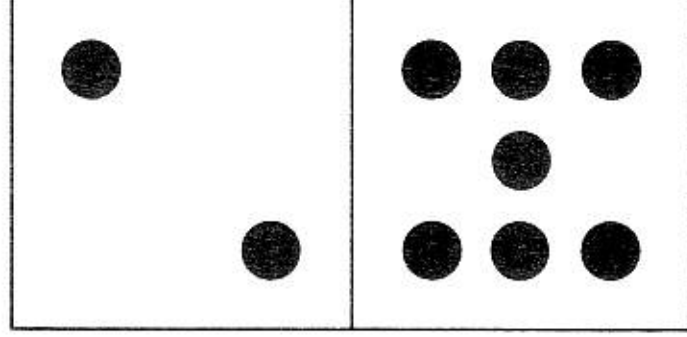
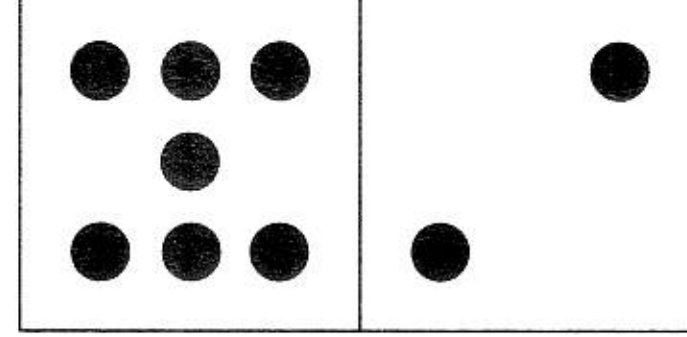
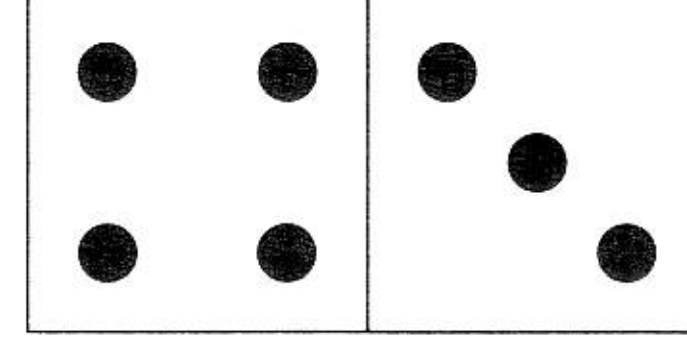
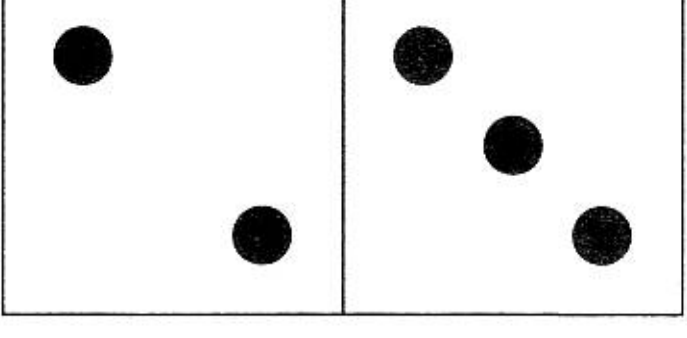
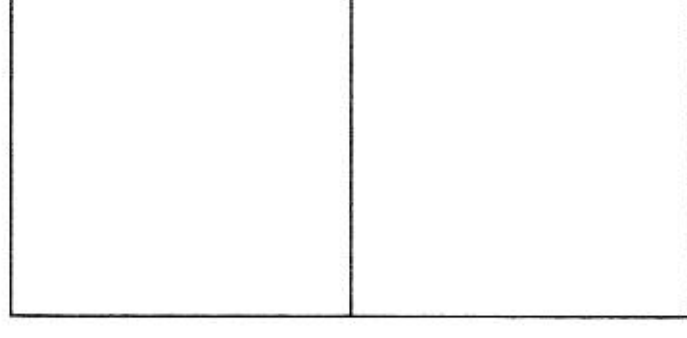
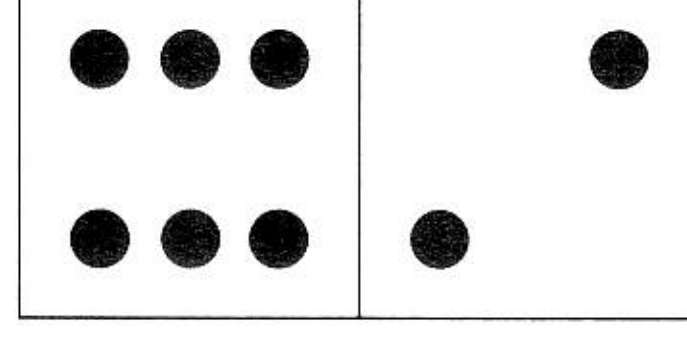
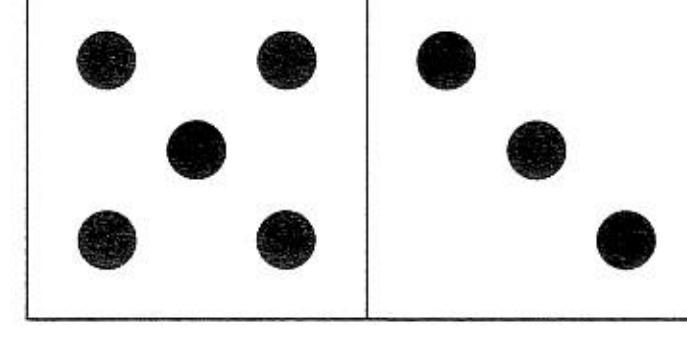
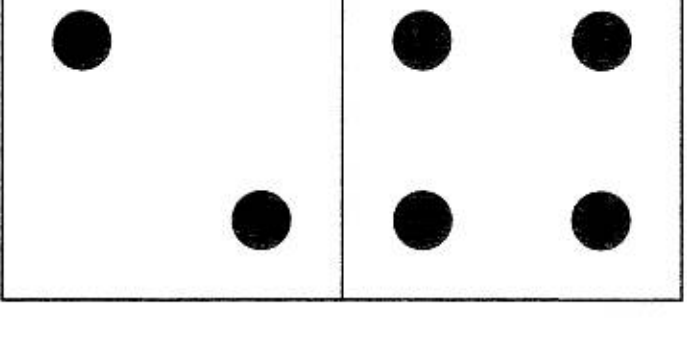
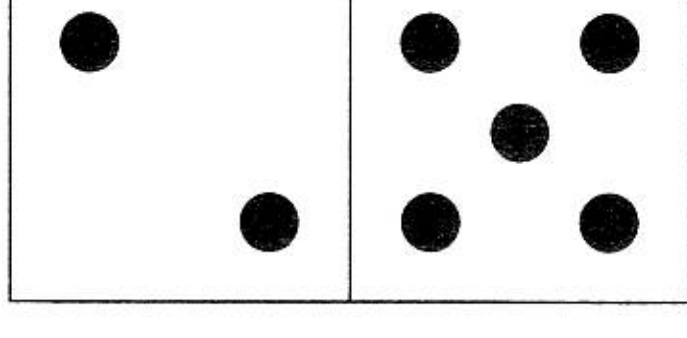
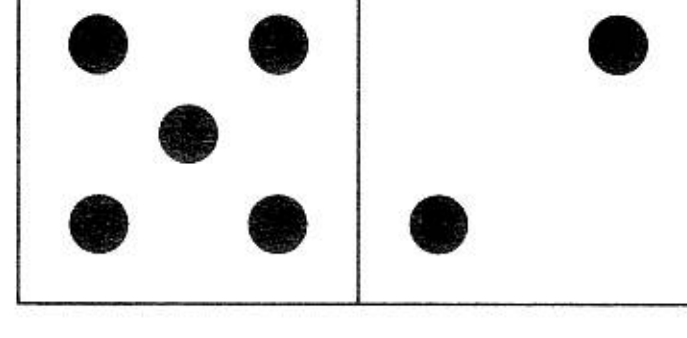
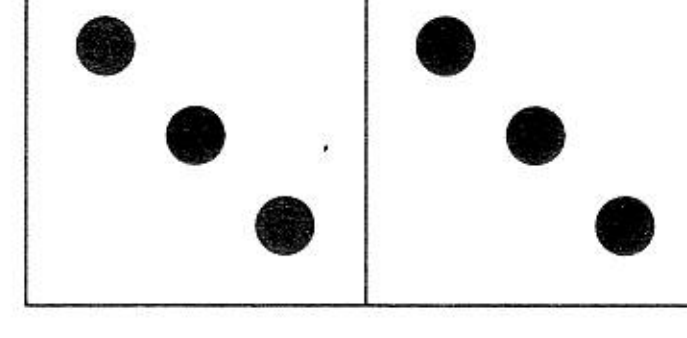
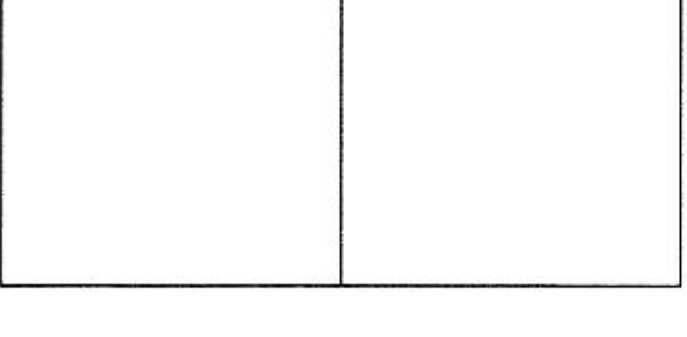
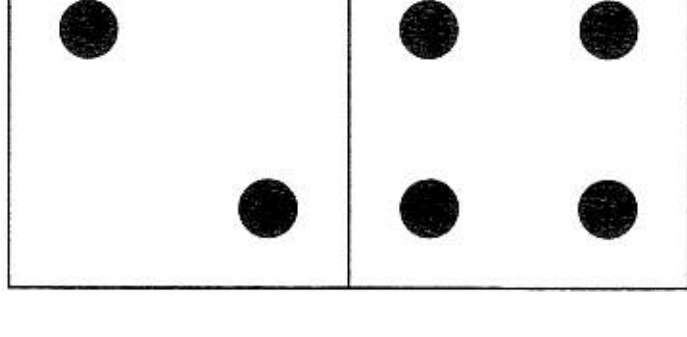
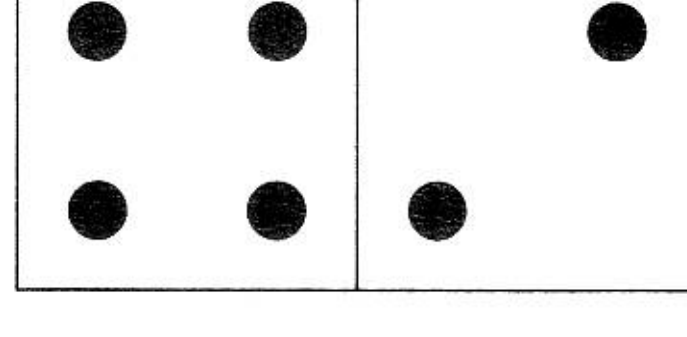
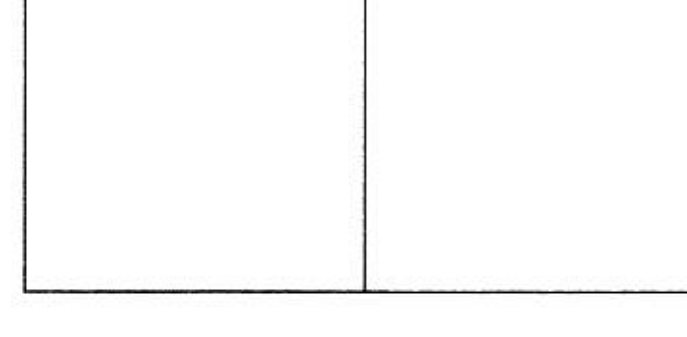
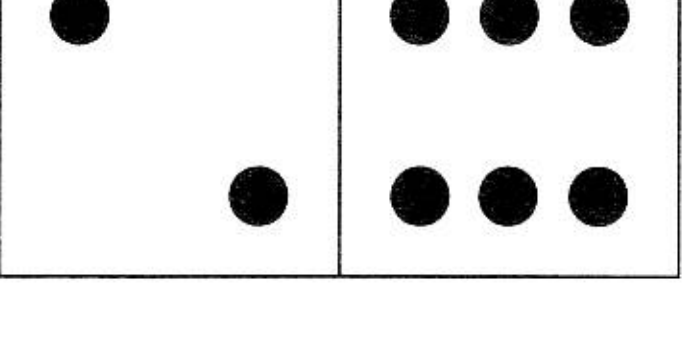
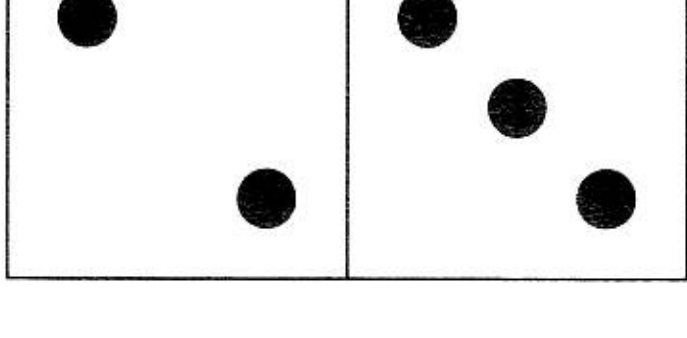
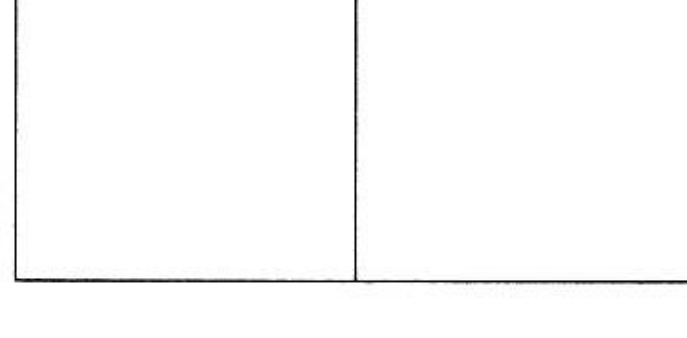
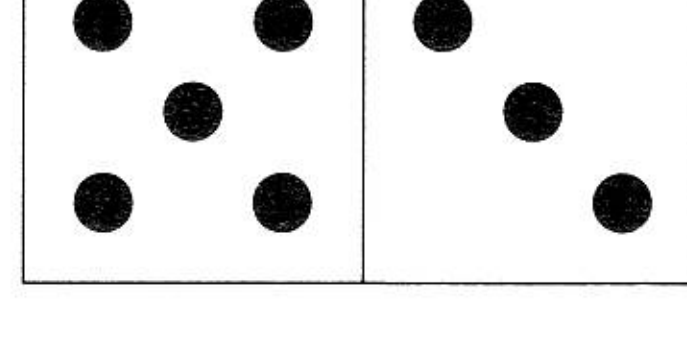
1	2	3	4
			
			
			
			
			
			

5

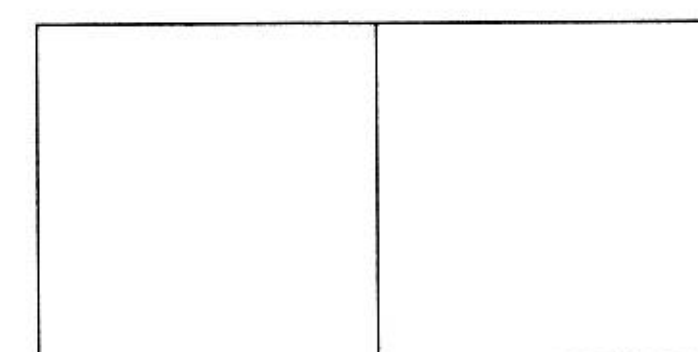
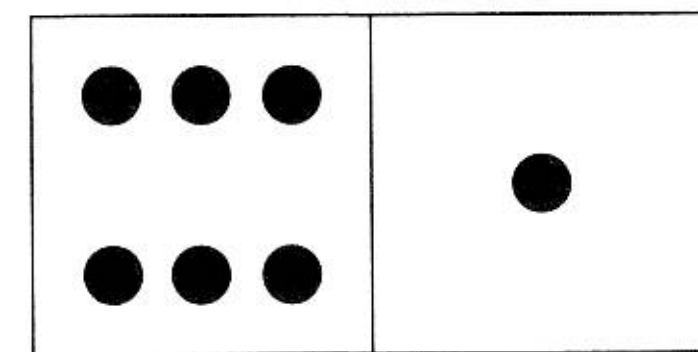
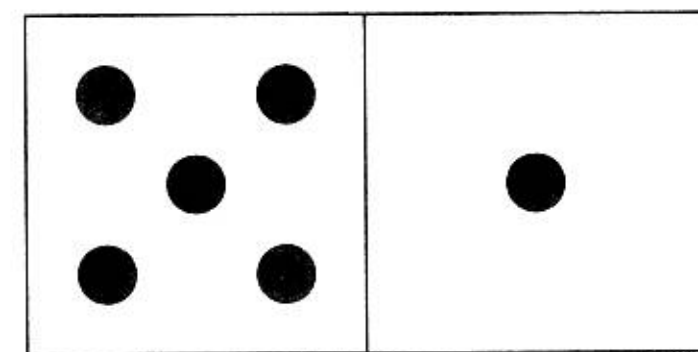
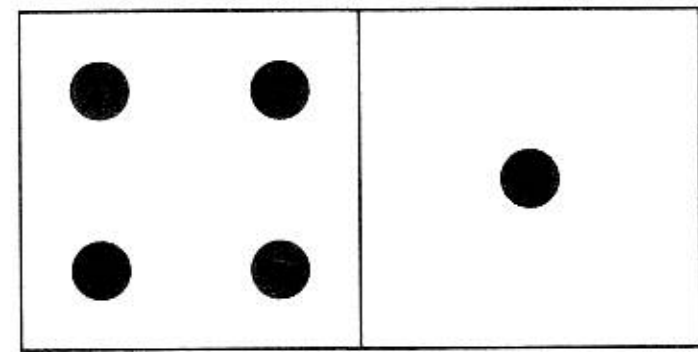
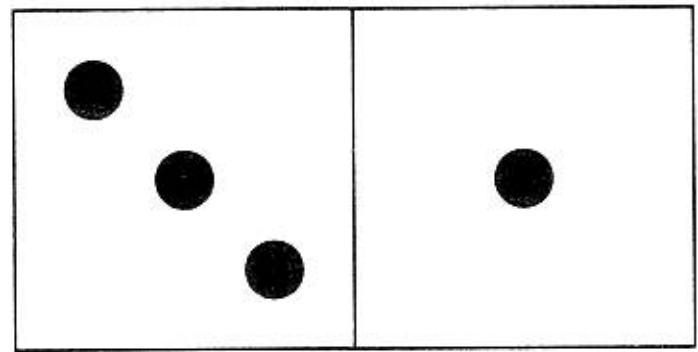
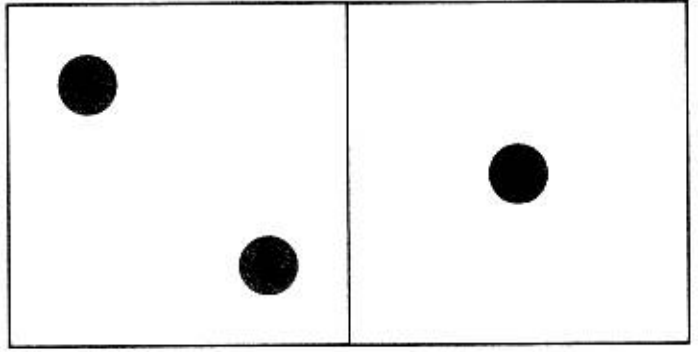

6

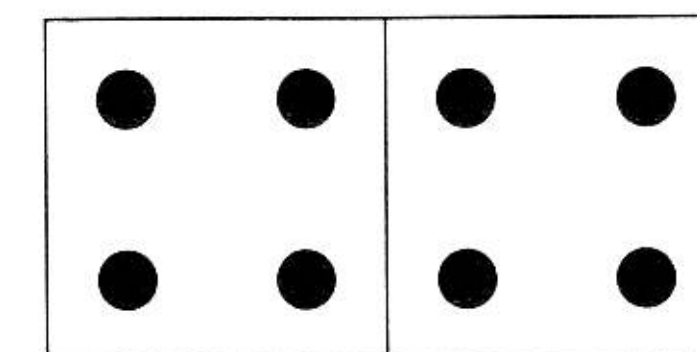
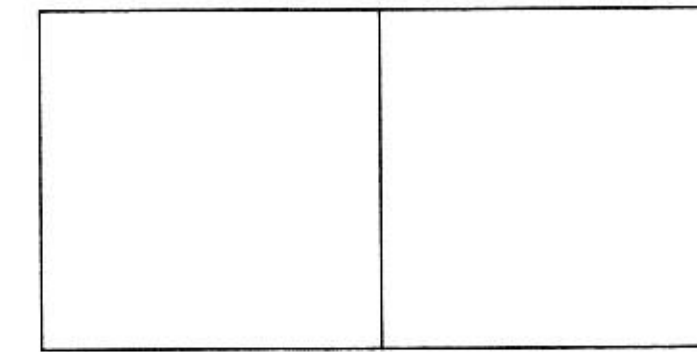
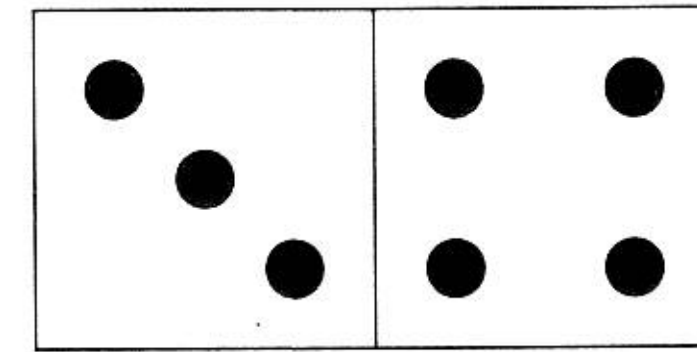
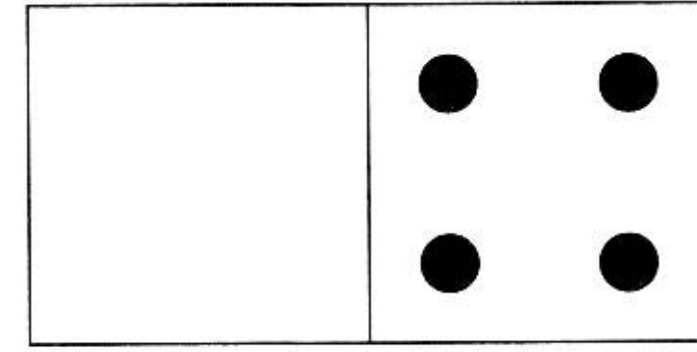
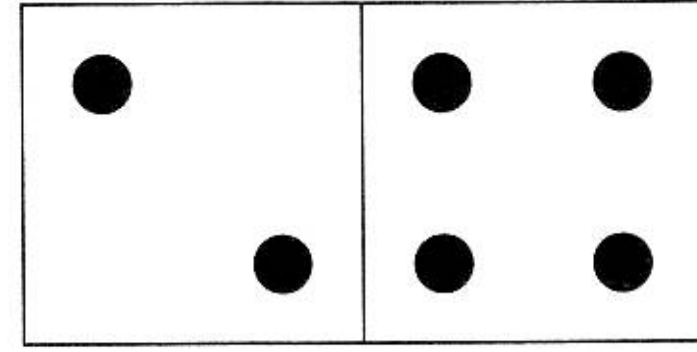
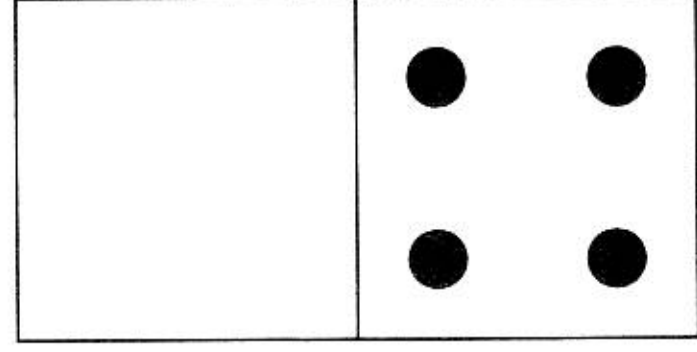

7

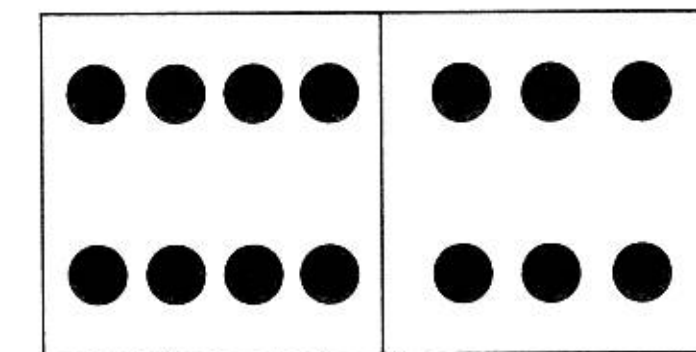
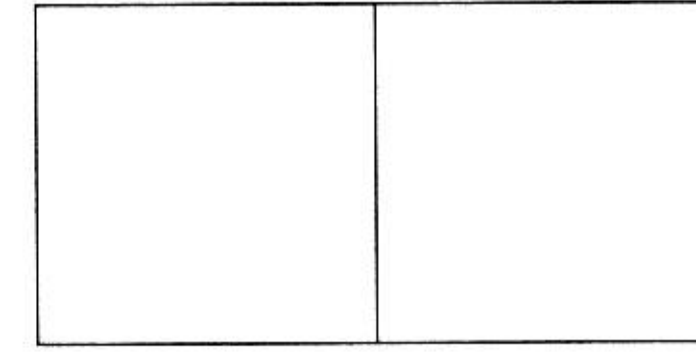
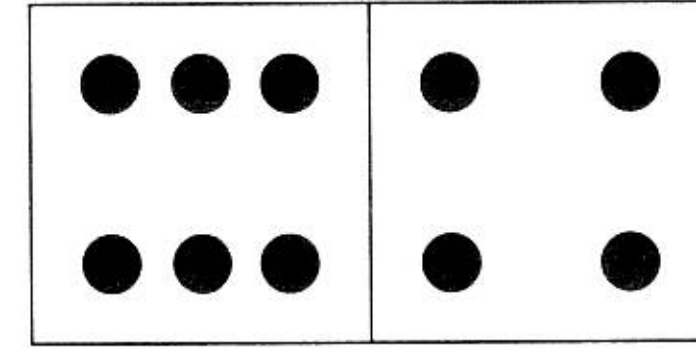
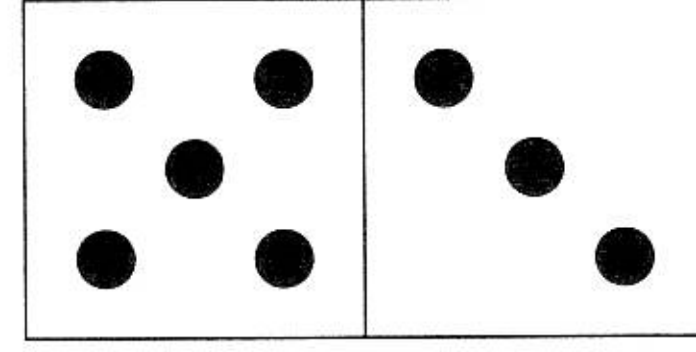
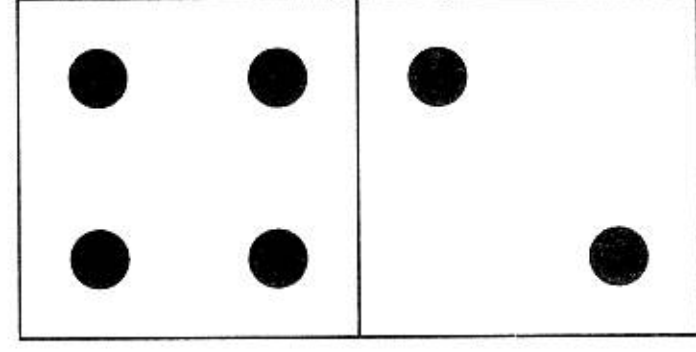
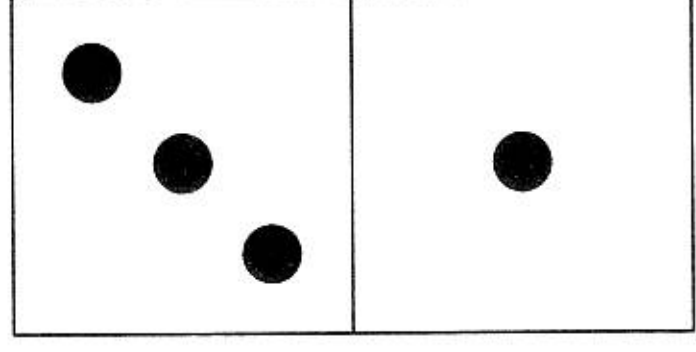

8

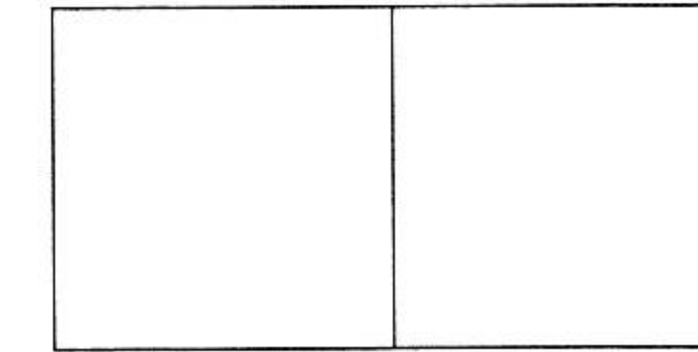
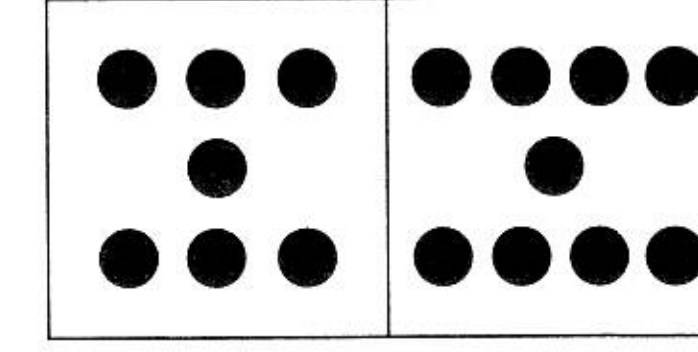
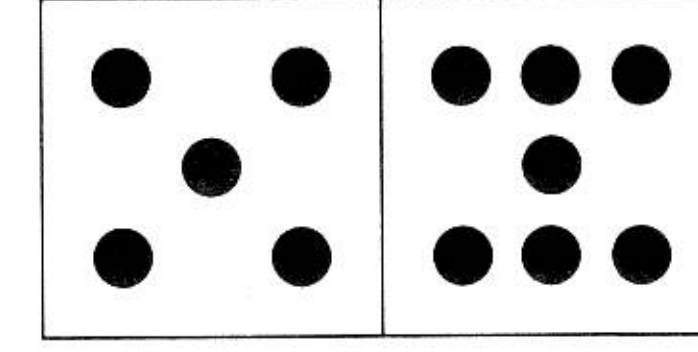
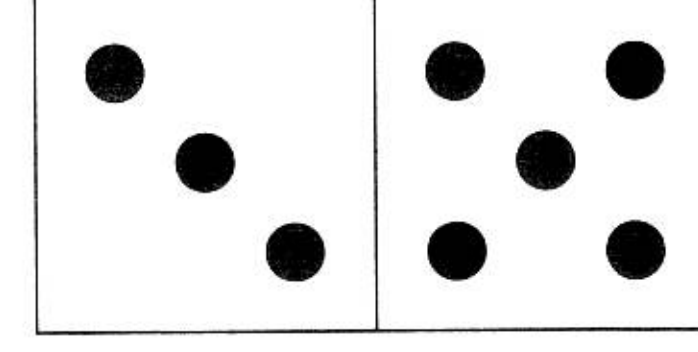
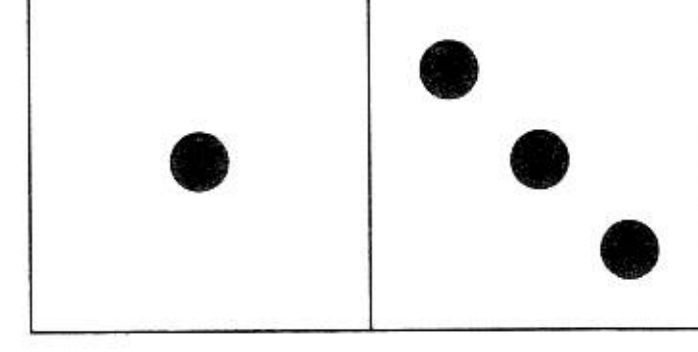
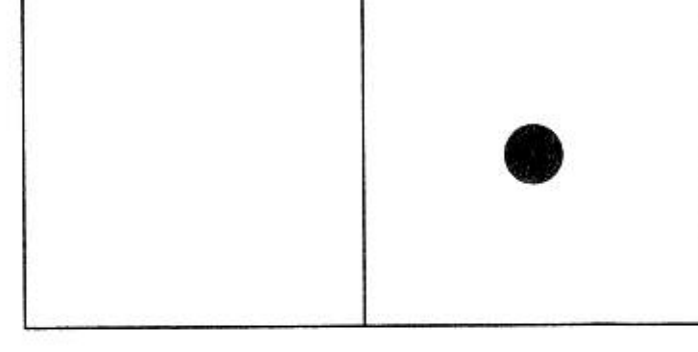

9

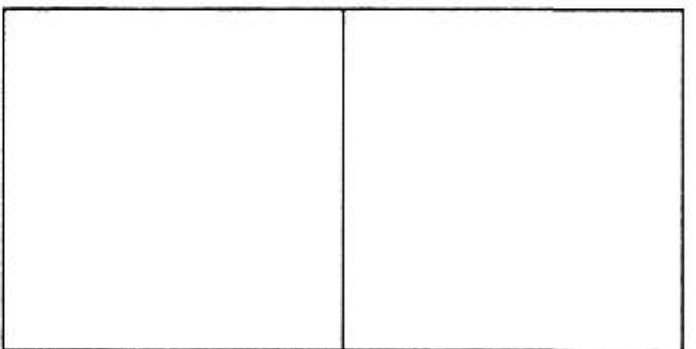
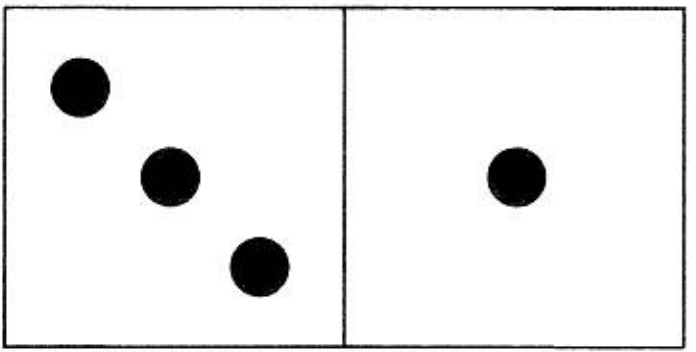
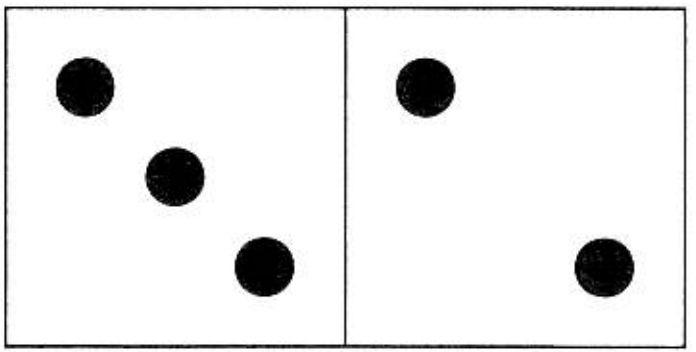
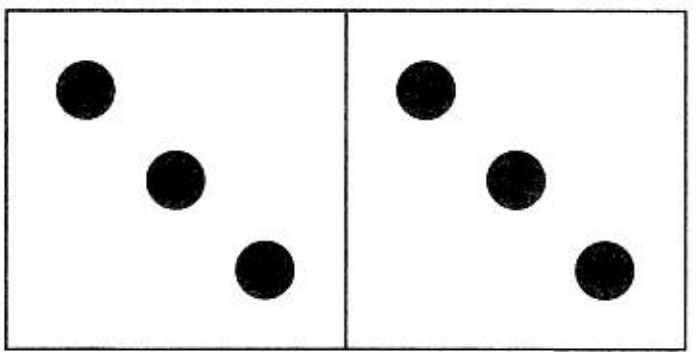
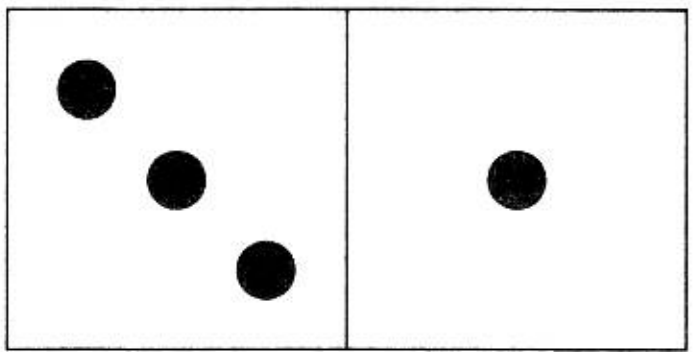
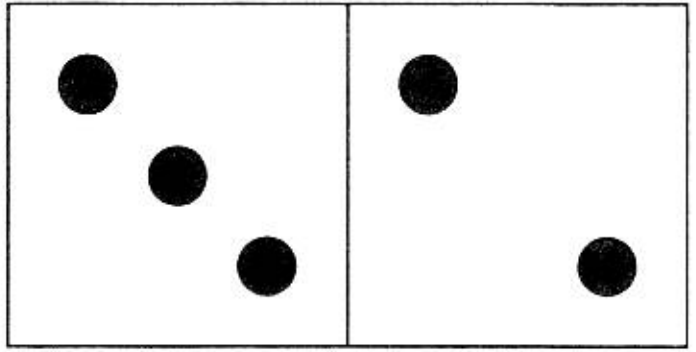

10

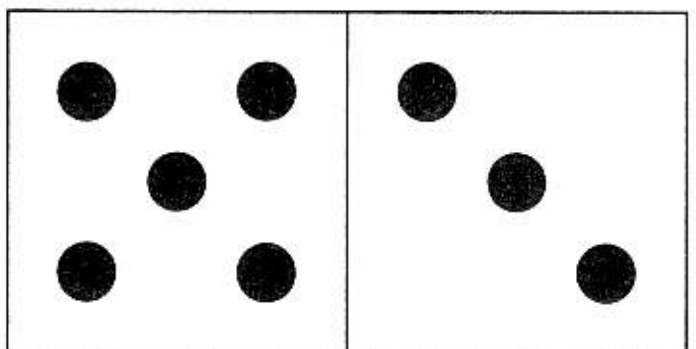
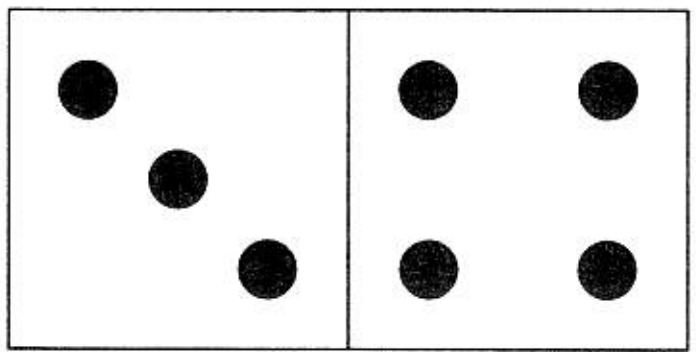
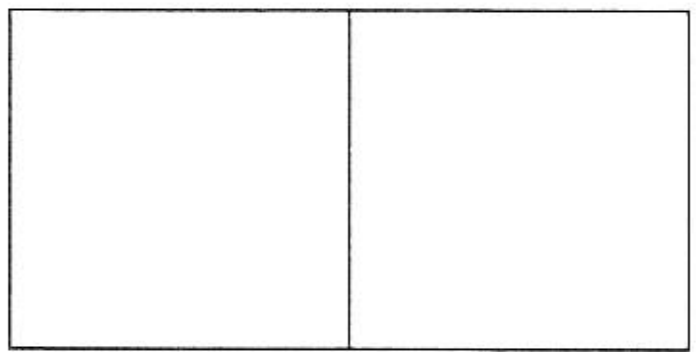
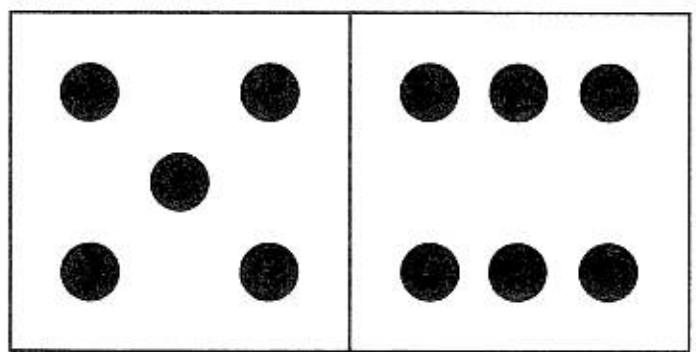
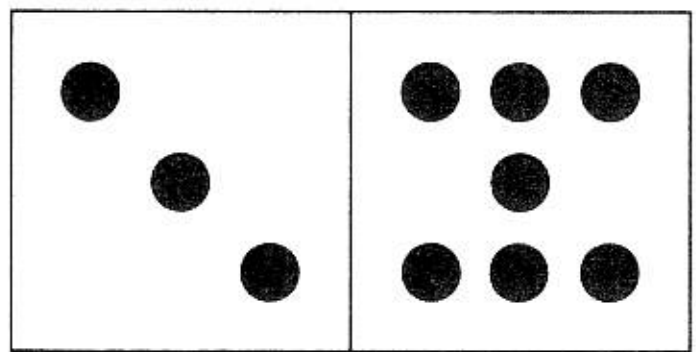
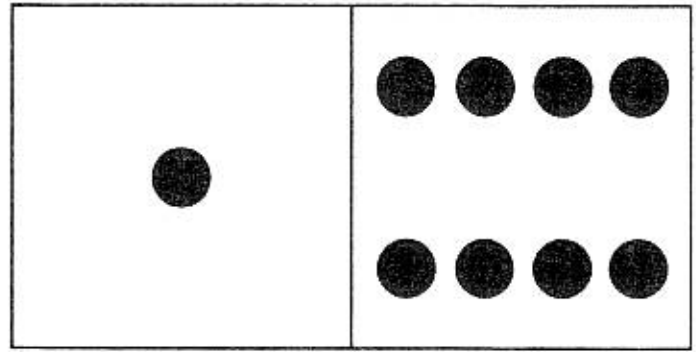

11

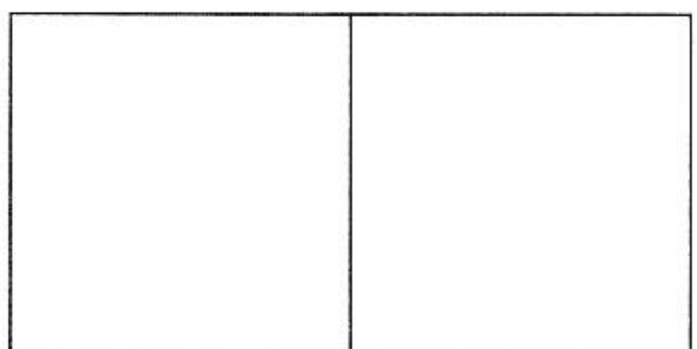
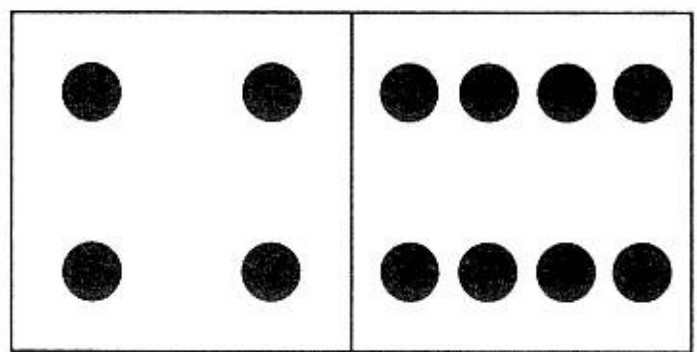
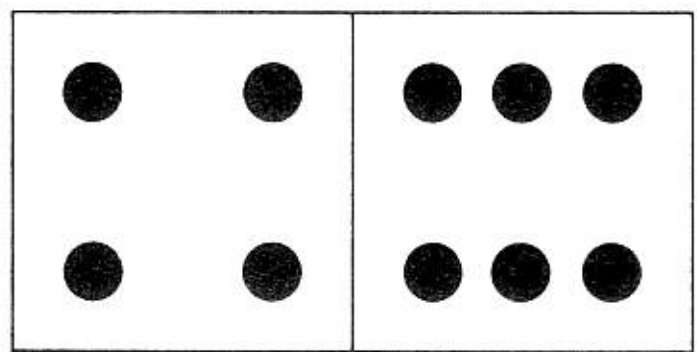
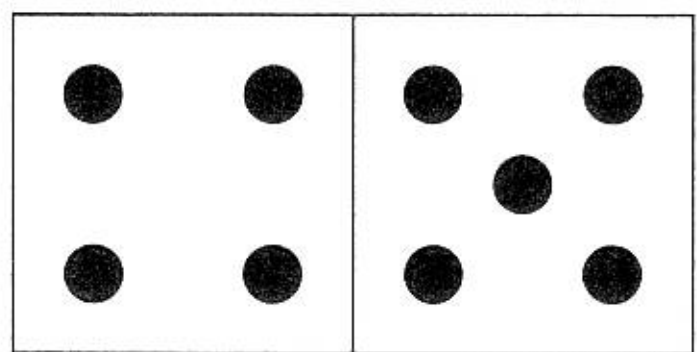
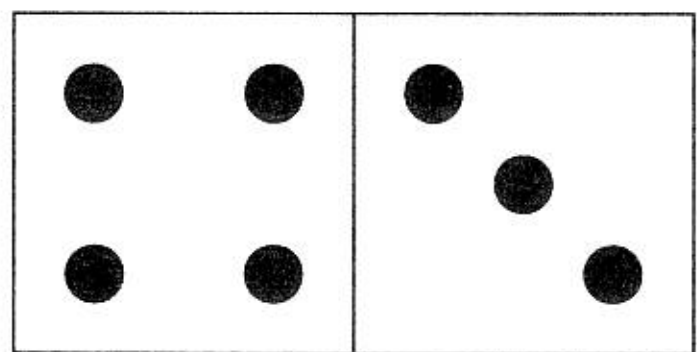
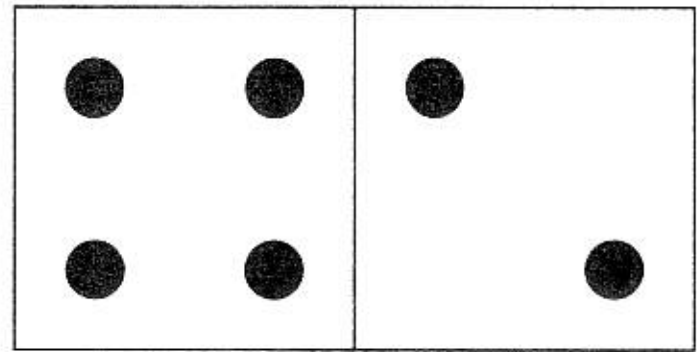

12

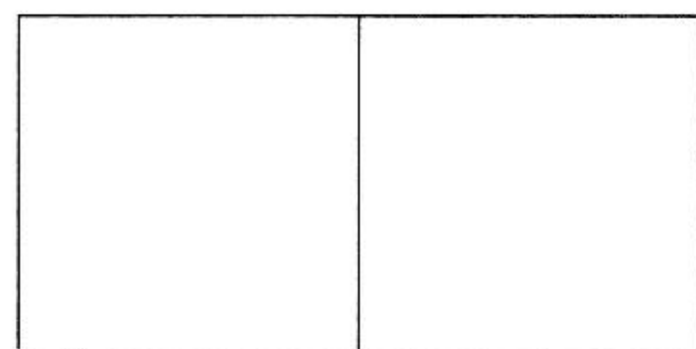
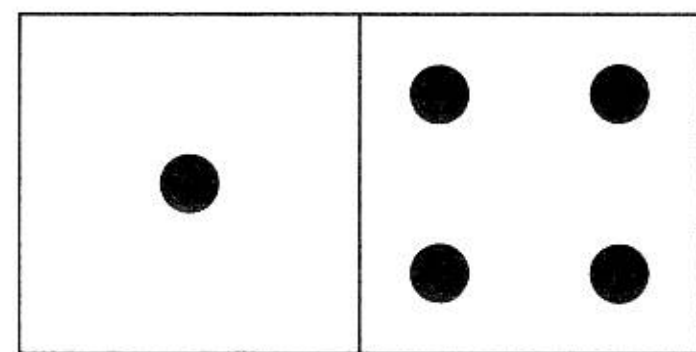
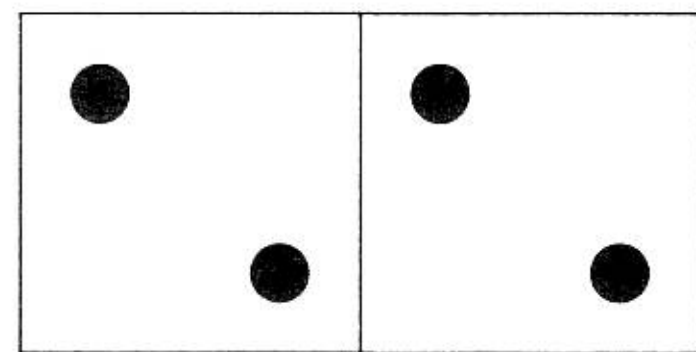
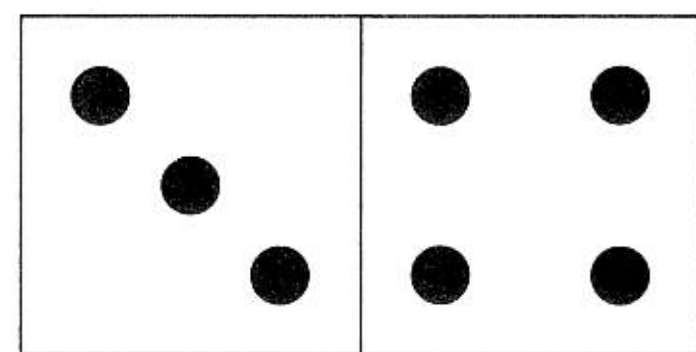
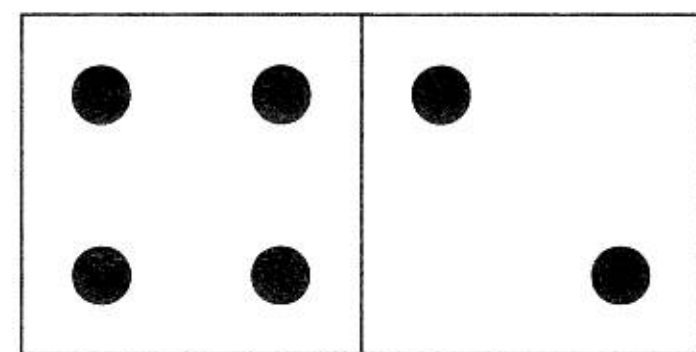
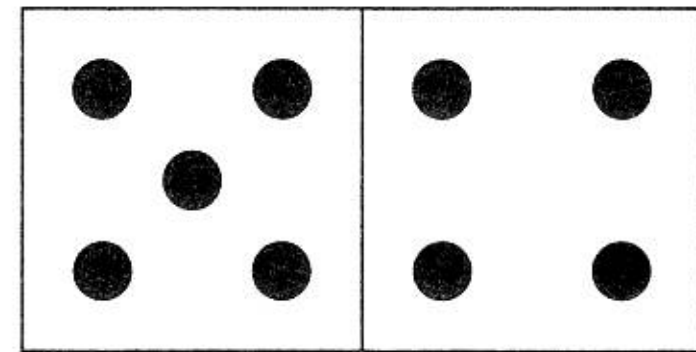

13

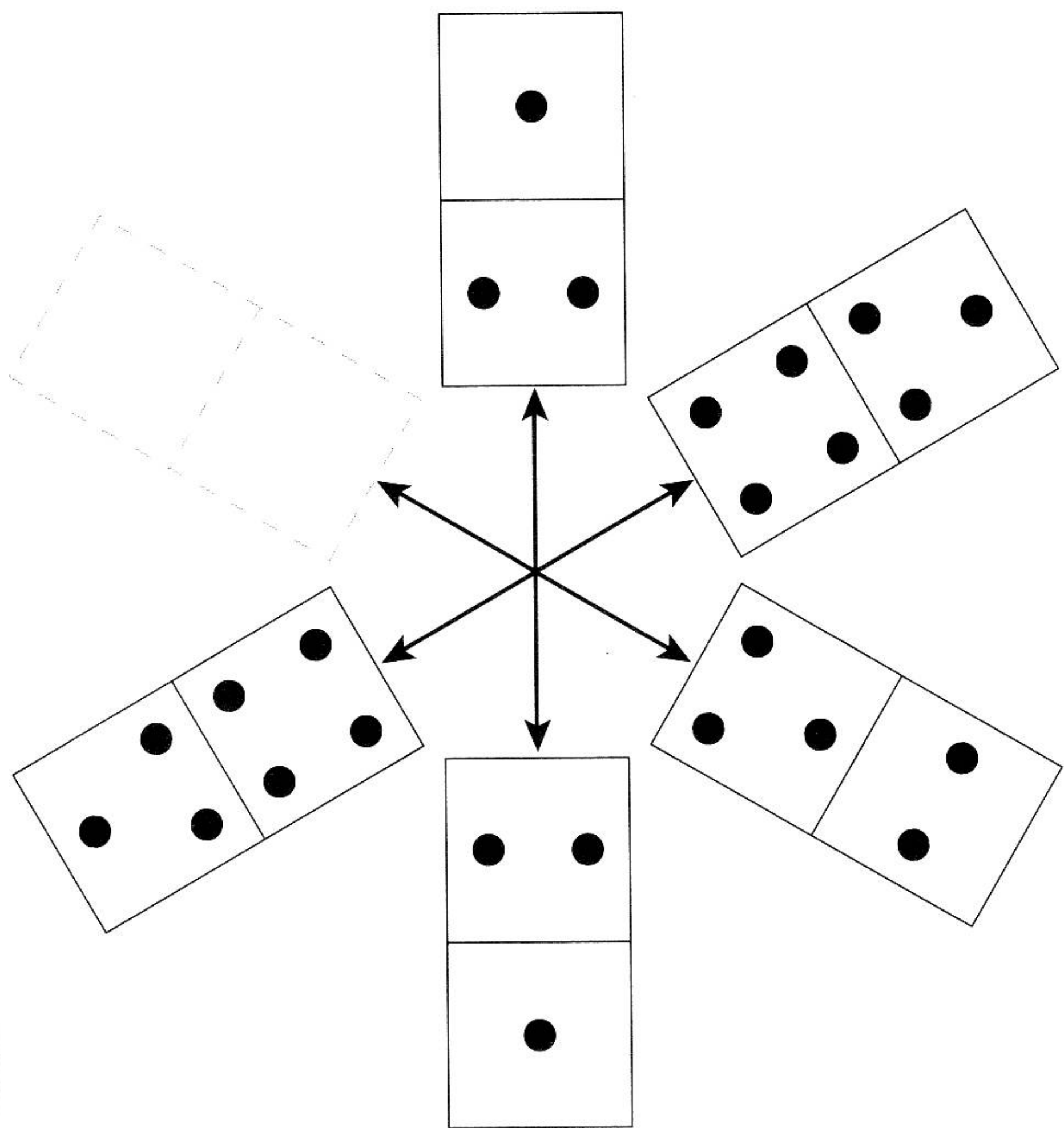

14

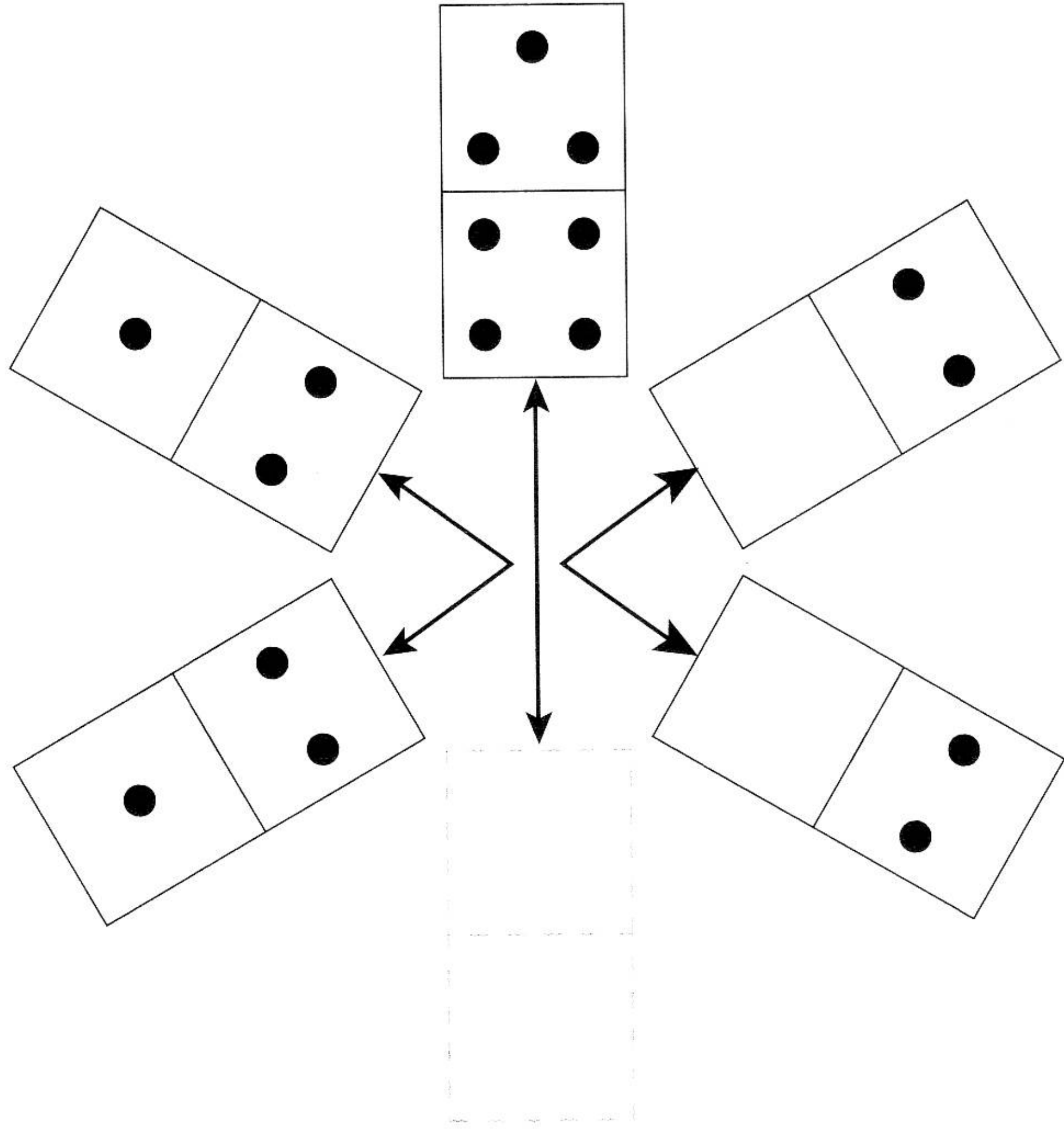

15

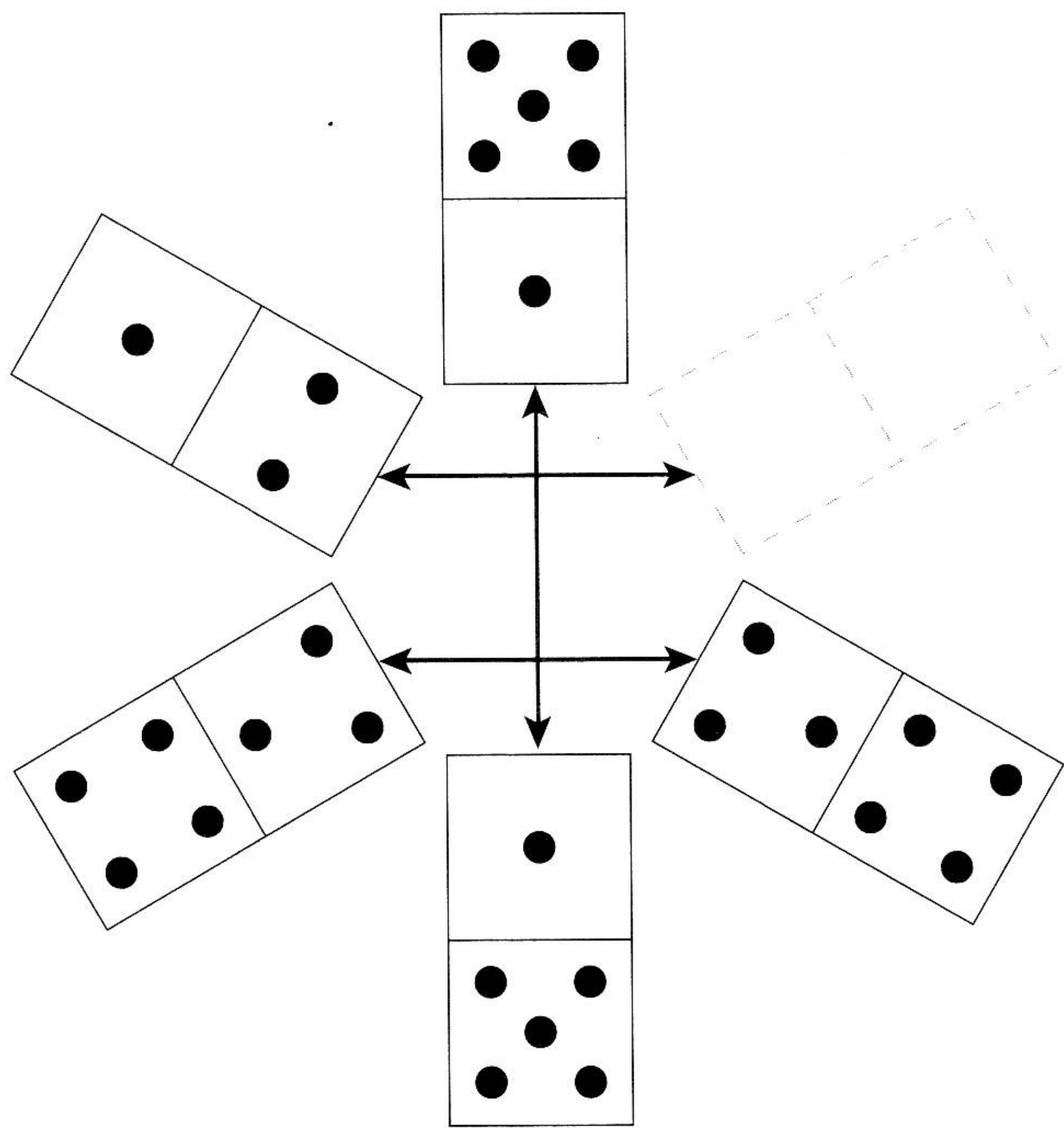

16

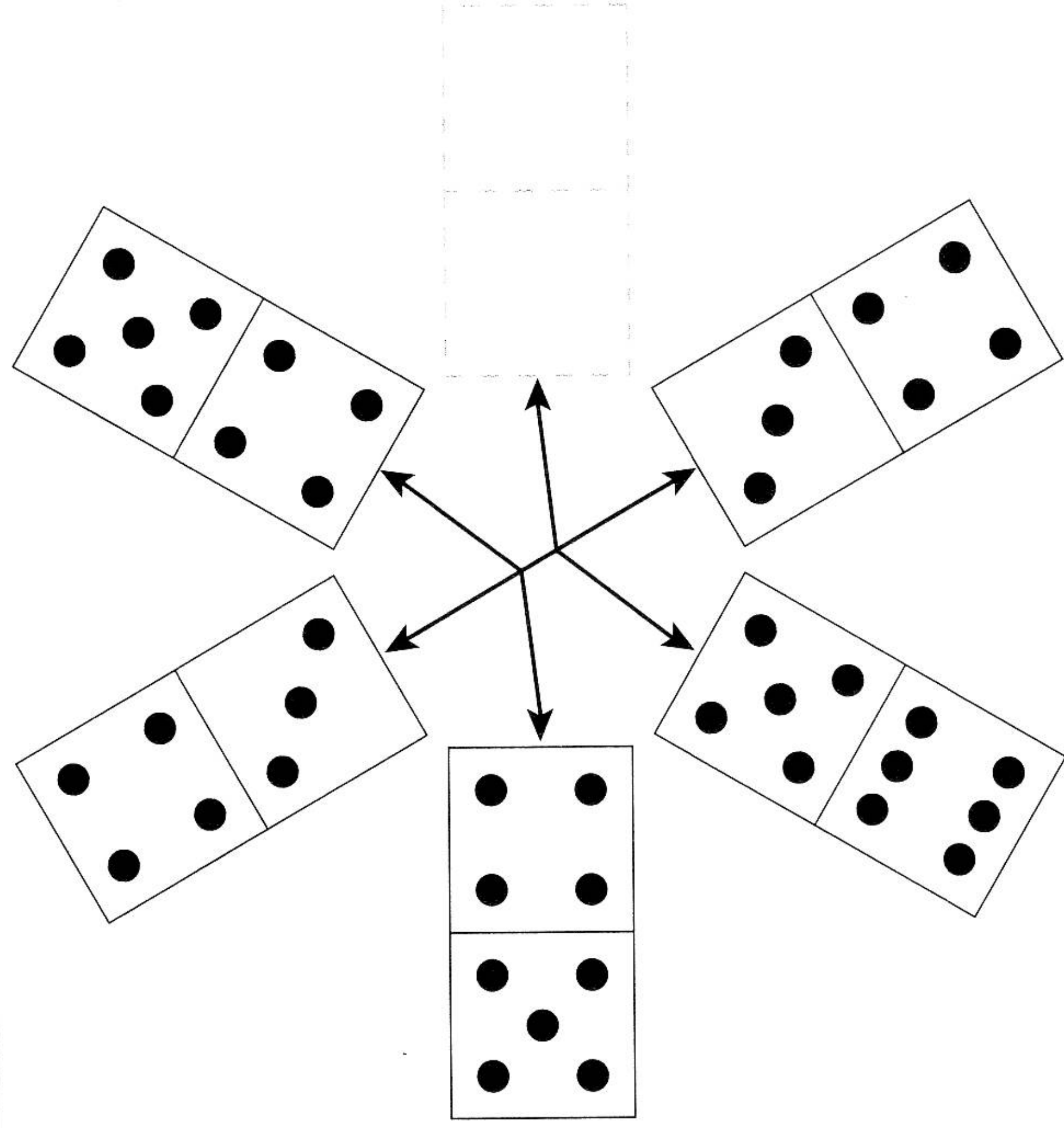

17

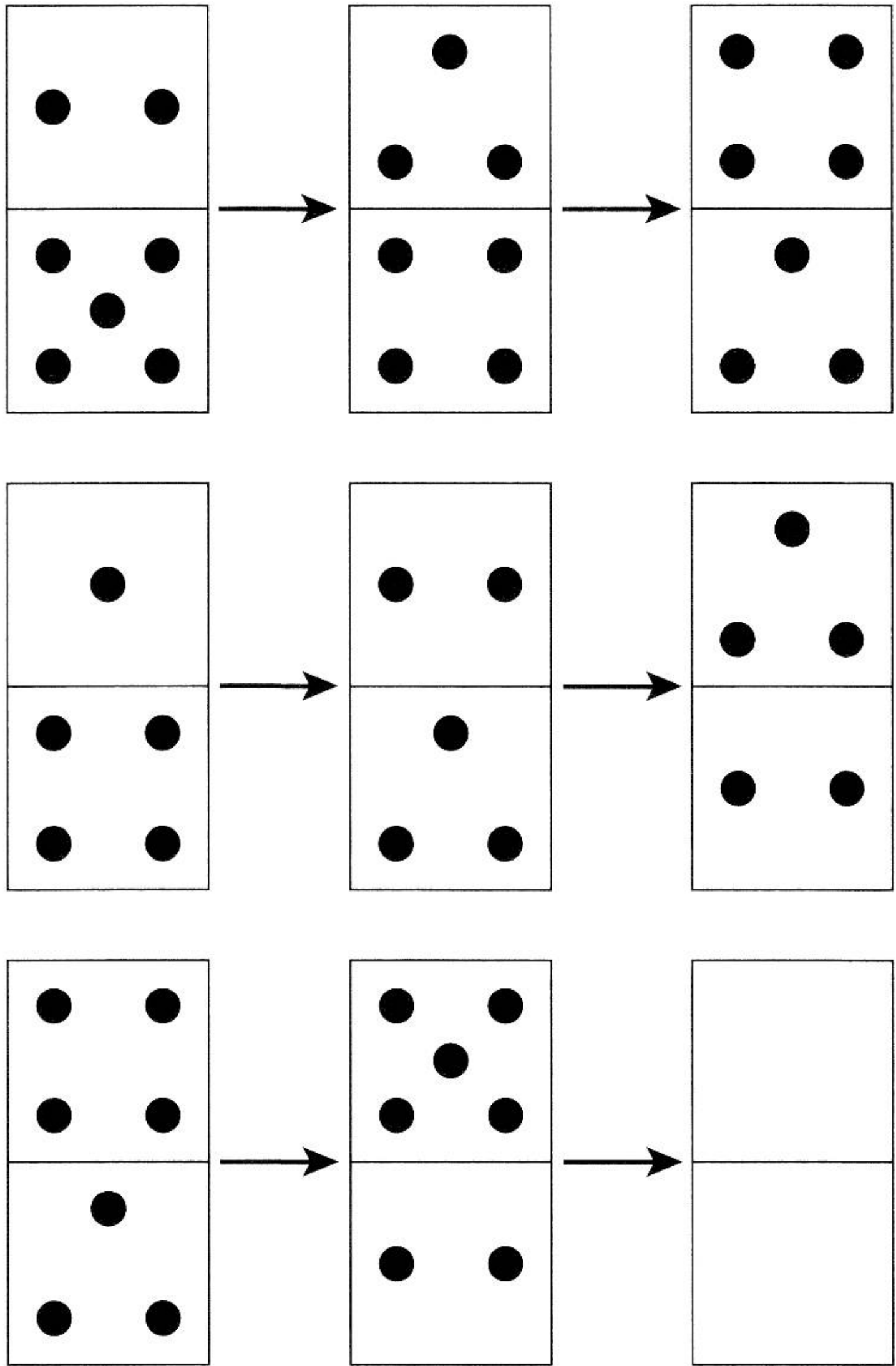

18

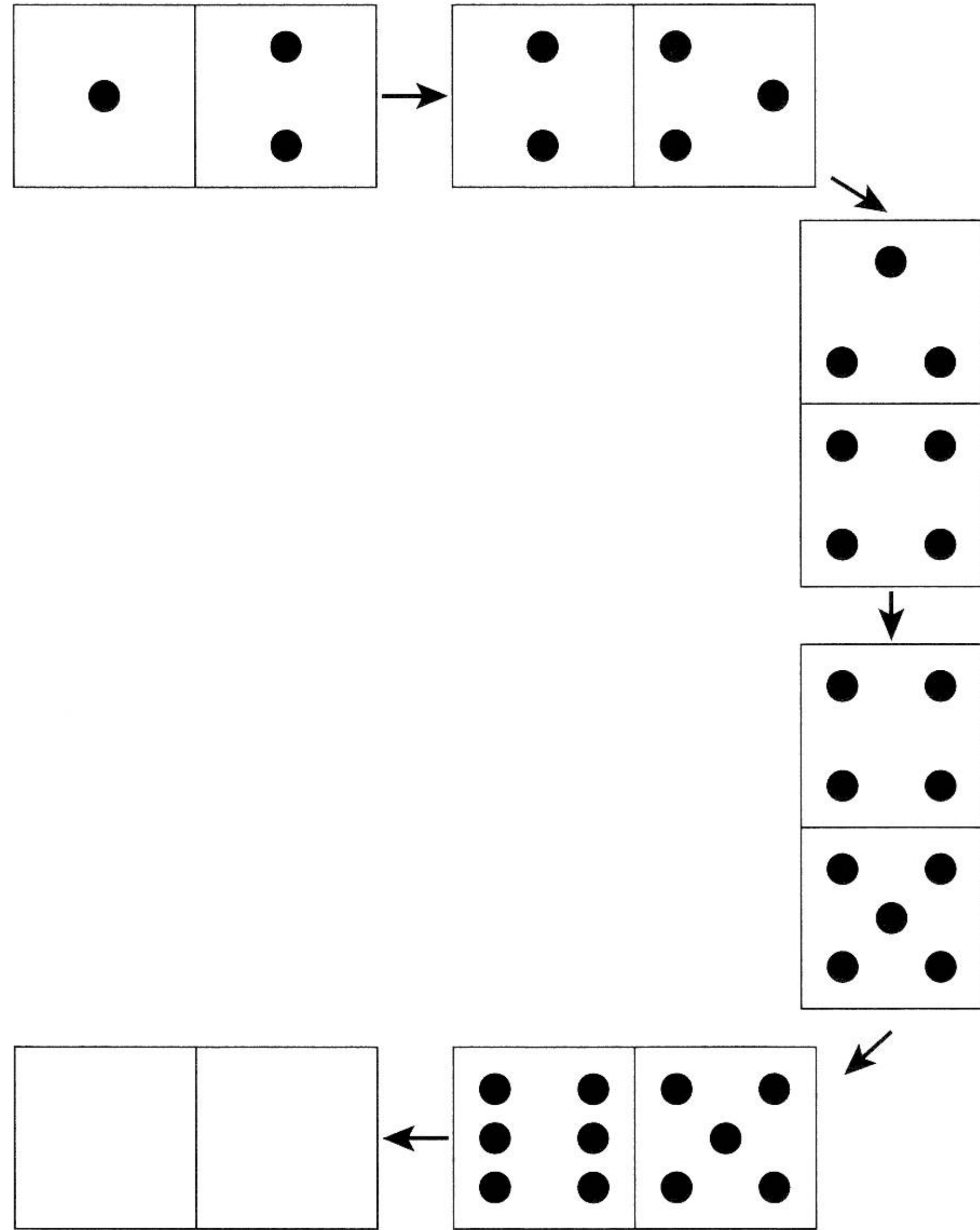

19

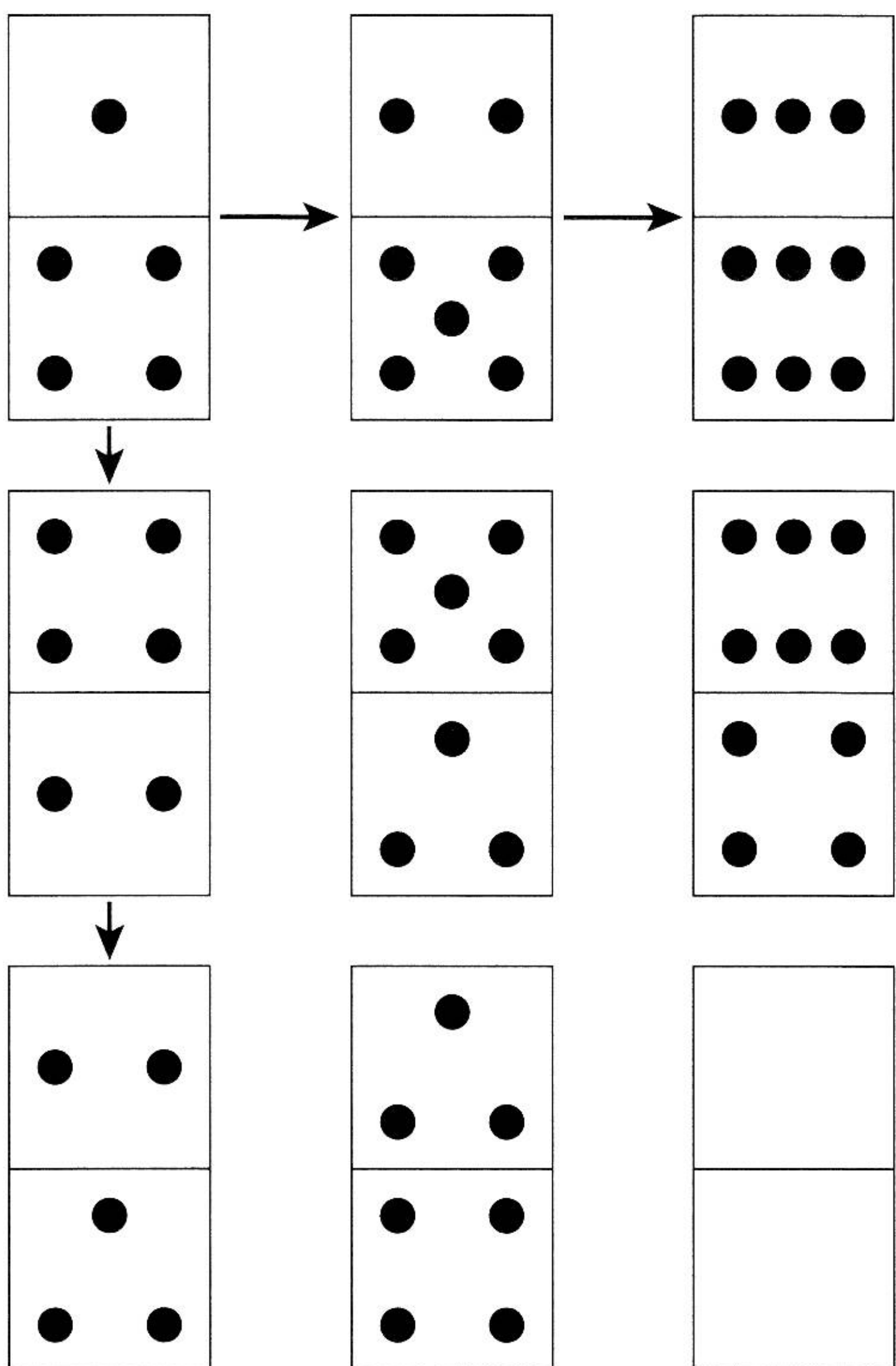

20

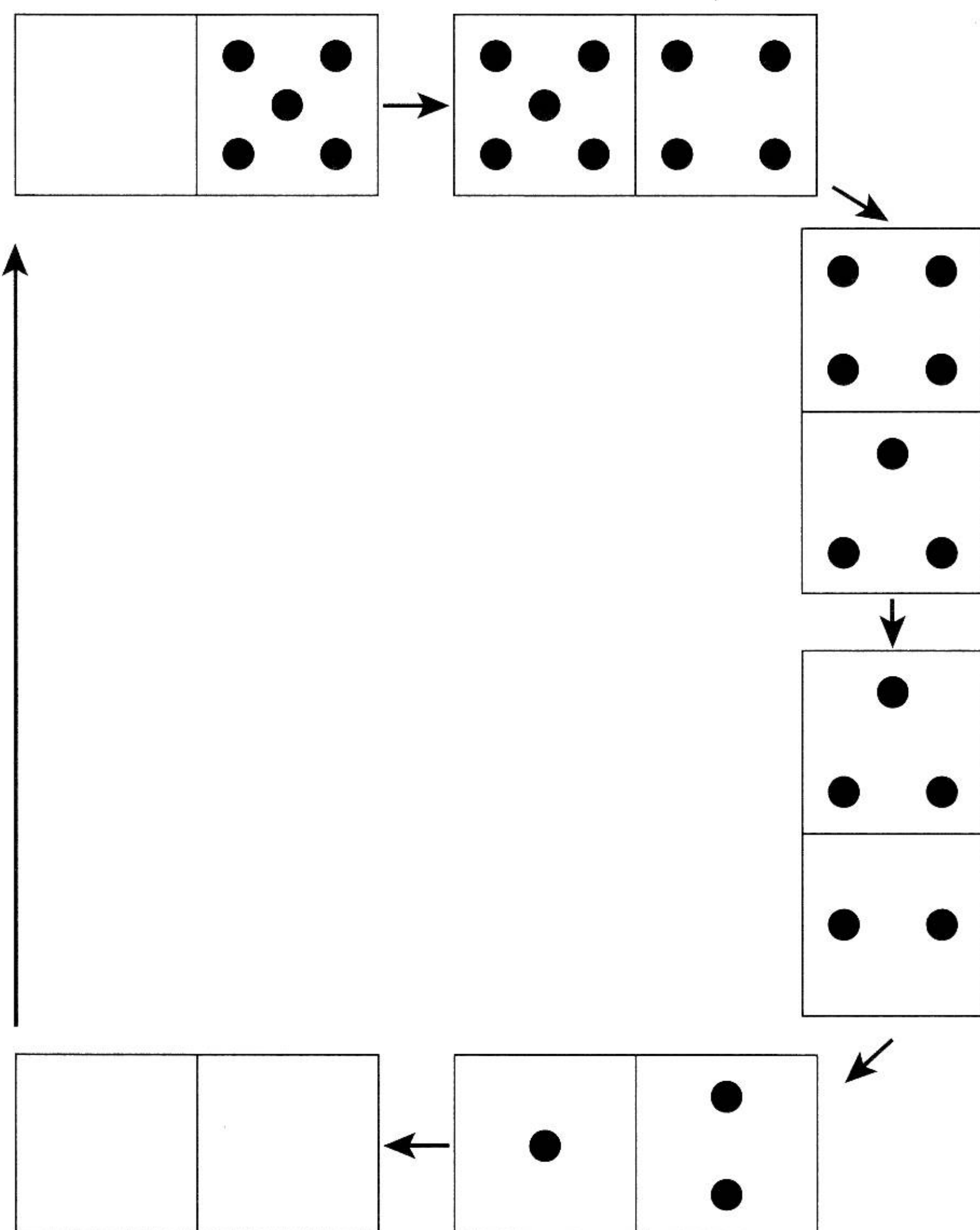

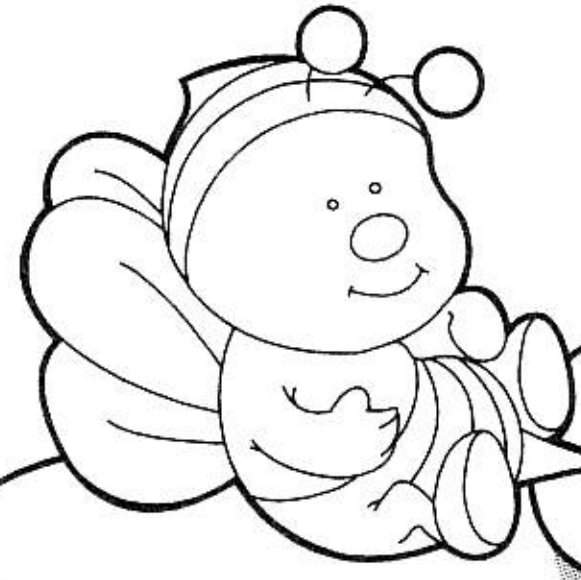

## ตอนที่ 3

### การหาภาพที่สมบูรณ์

- การหารูปทรงมาเติมภาพให้สมบูรณ์ 20 ข้อ
- การหาภาพที่เกิดจากการตัดหรือ  
เจาะกระดาษที่พับ 20 ข้อ
- การหาภาพที่พับแล้วได้รูปกล่องเหมือนแบบ 15 ข้อ



จง **X** ข้อที่มีชิ้นส่วนที่นำมาเติมภาพที่กำหนดได้พอดี

1

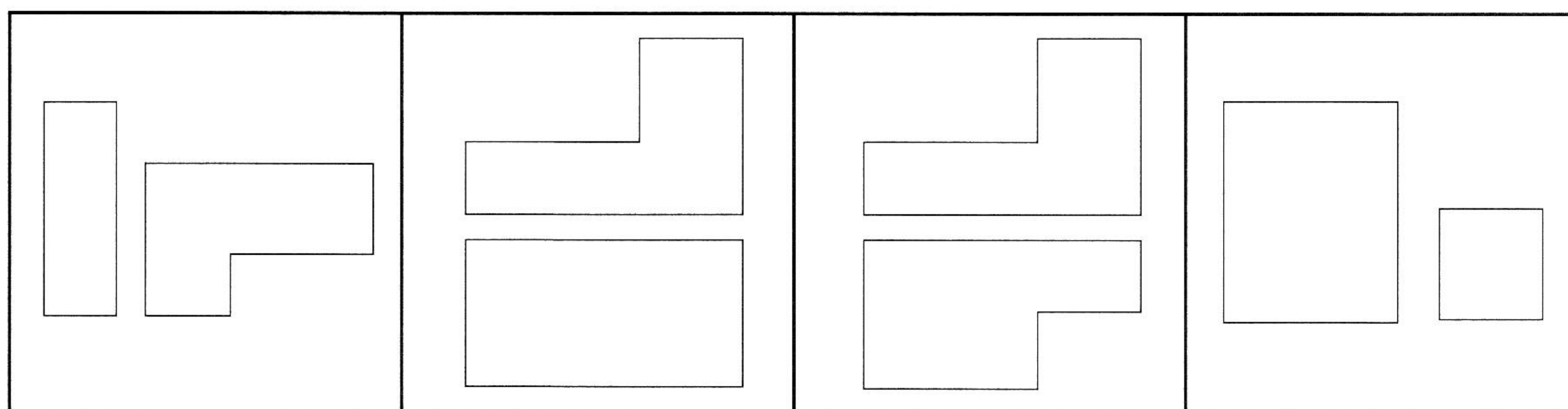
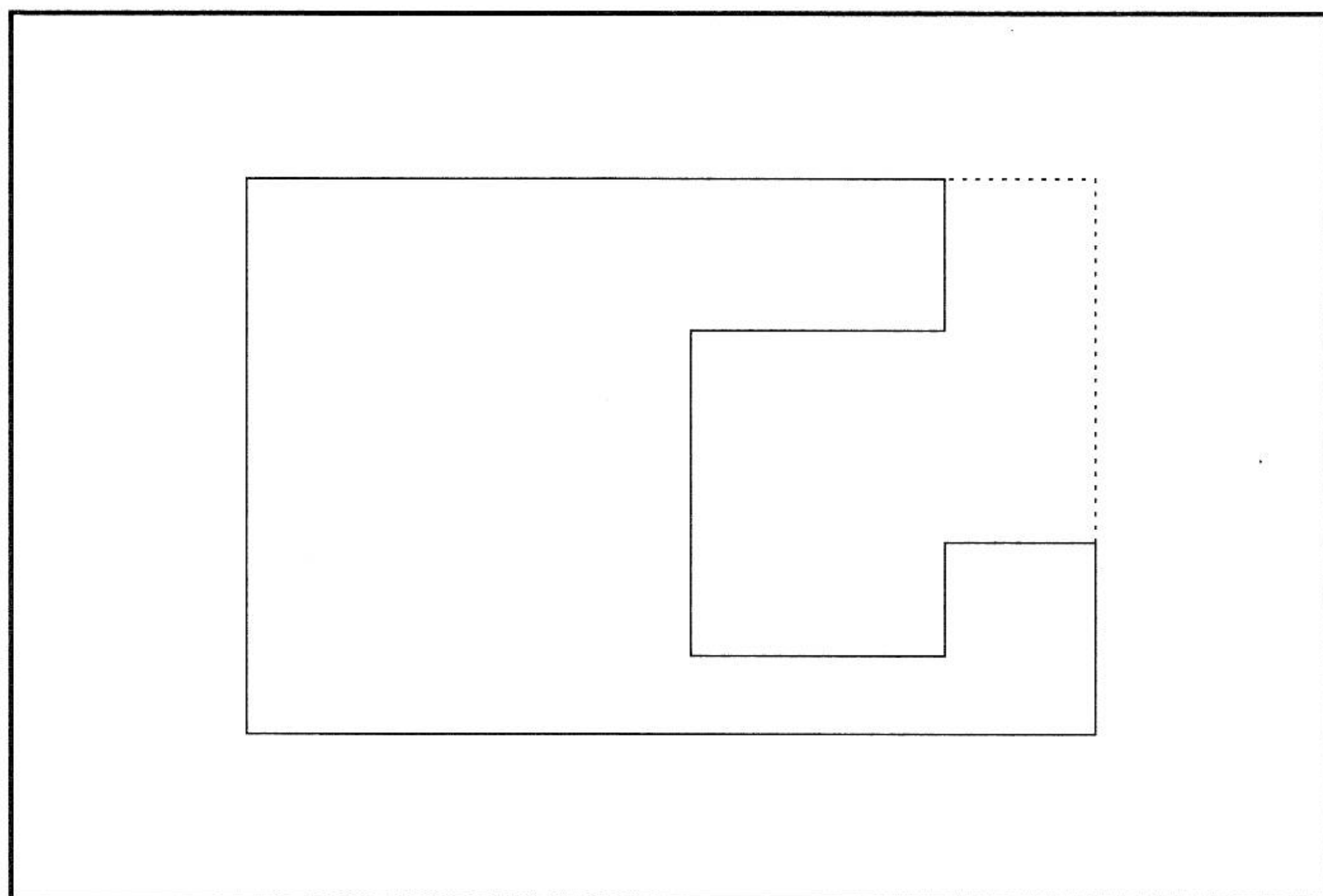

ก

ข

ค

ง

2

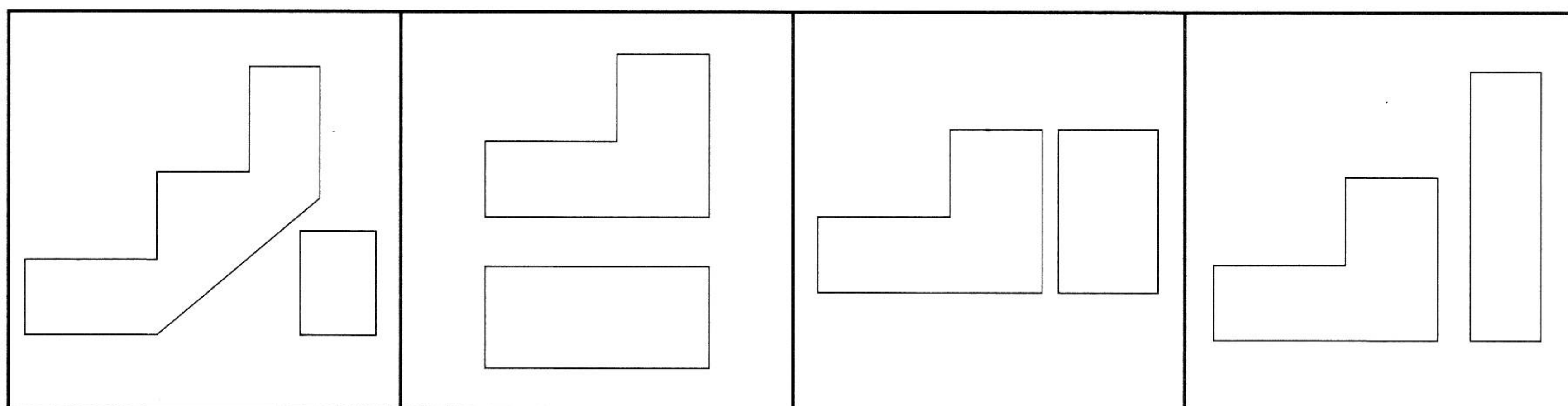
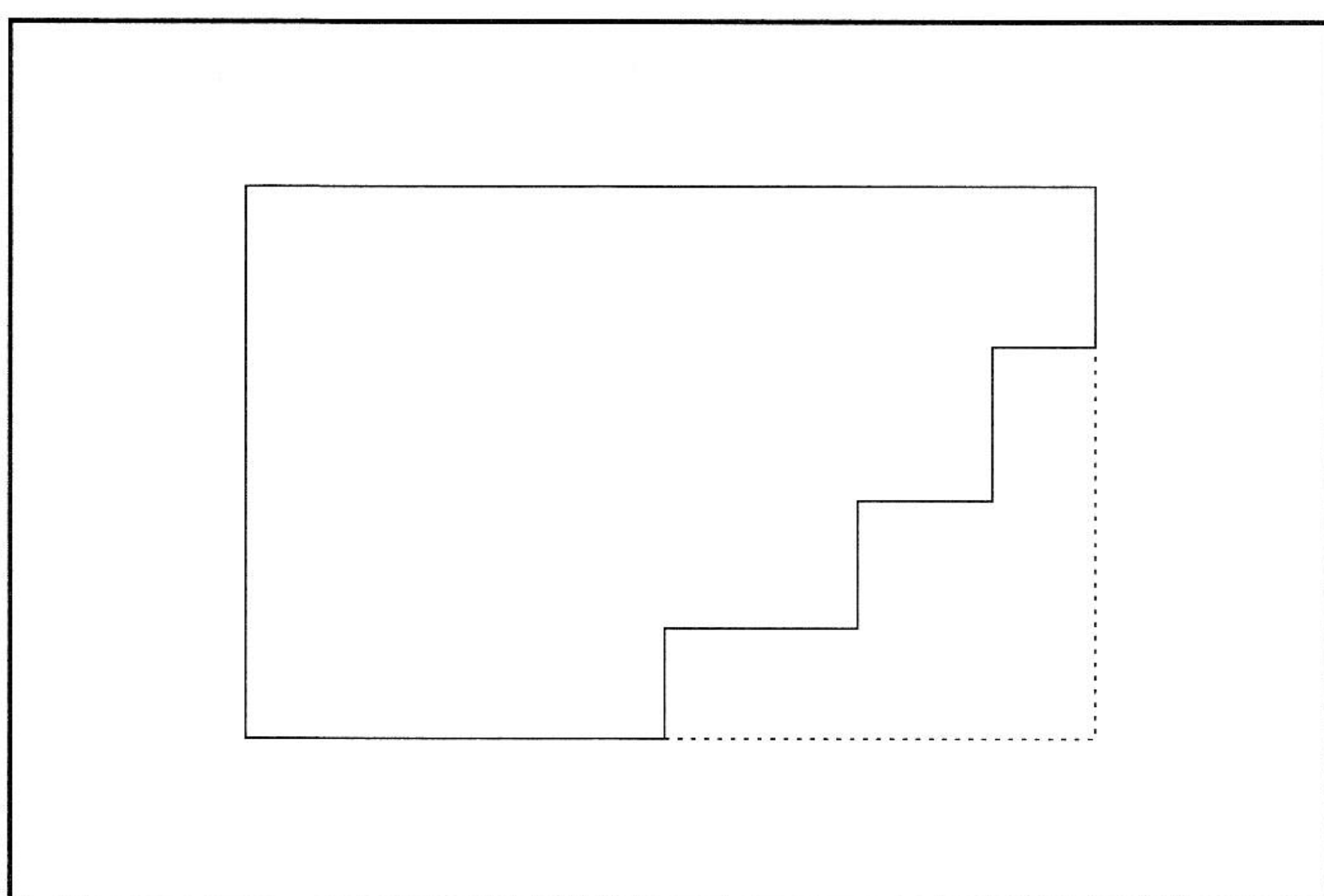

ก

ข

ค

ง

3

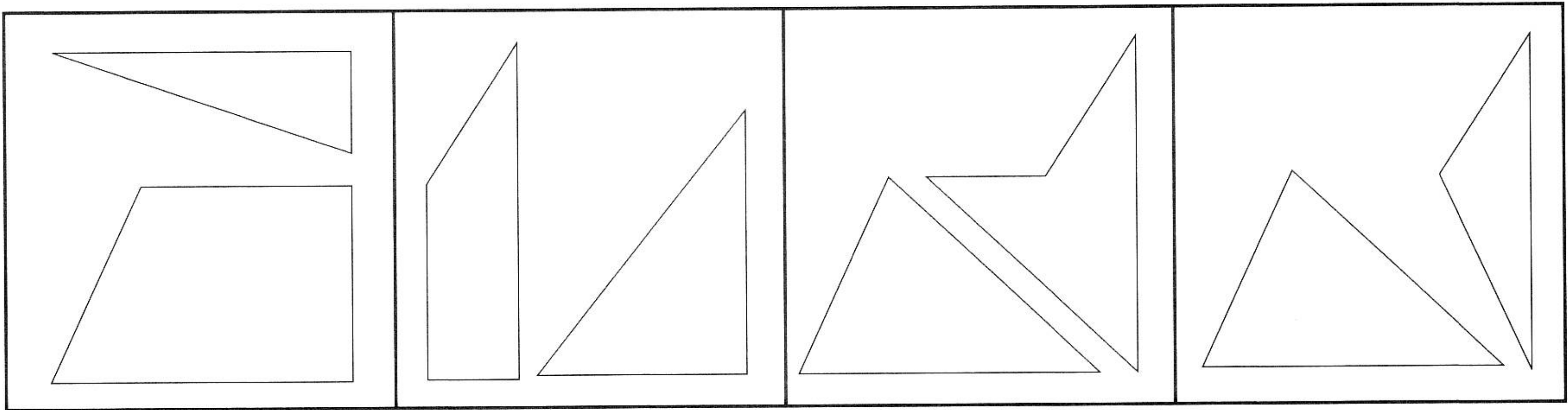
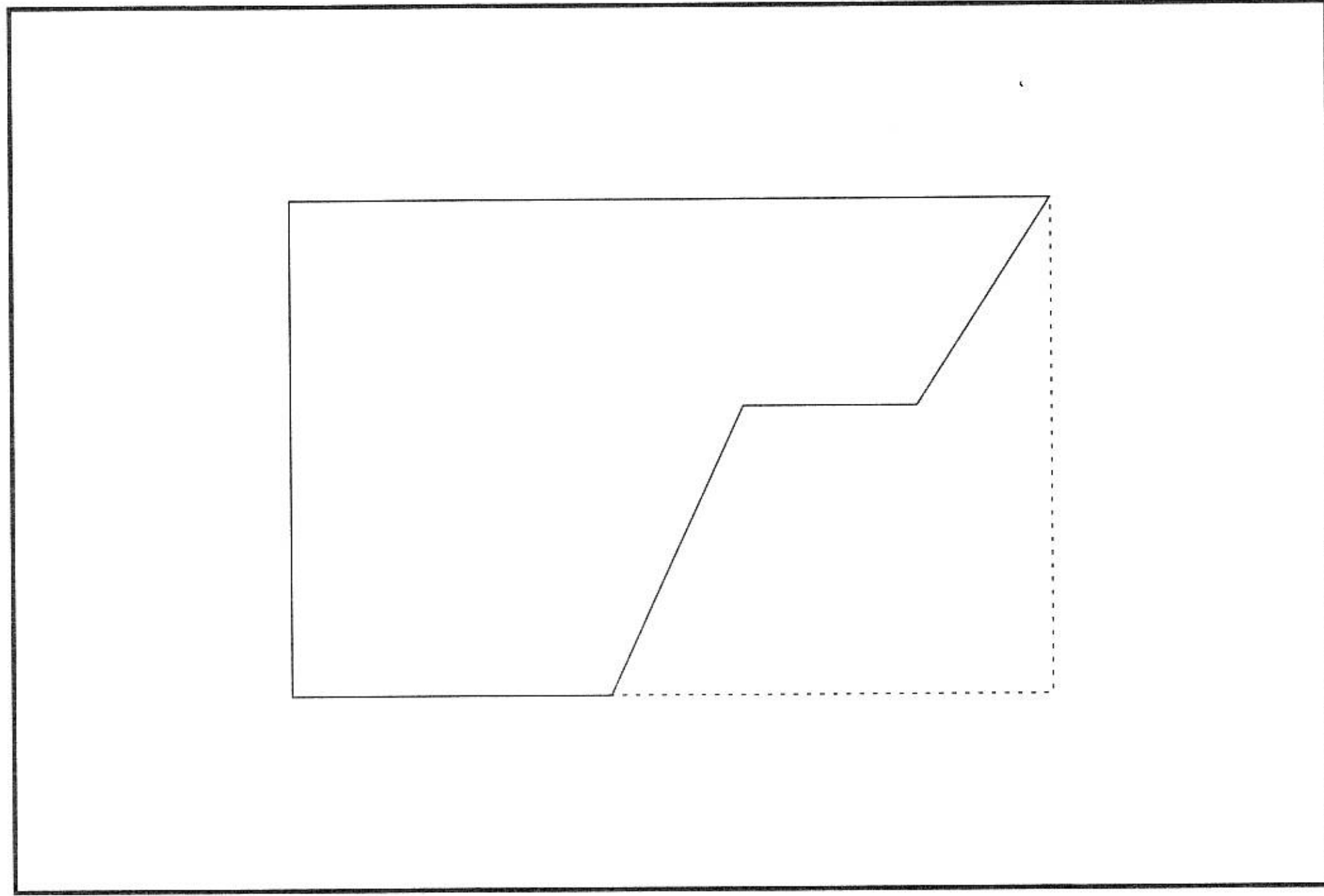

ก

ข

ค

ง

4

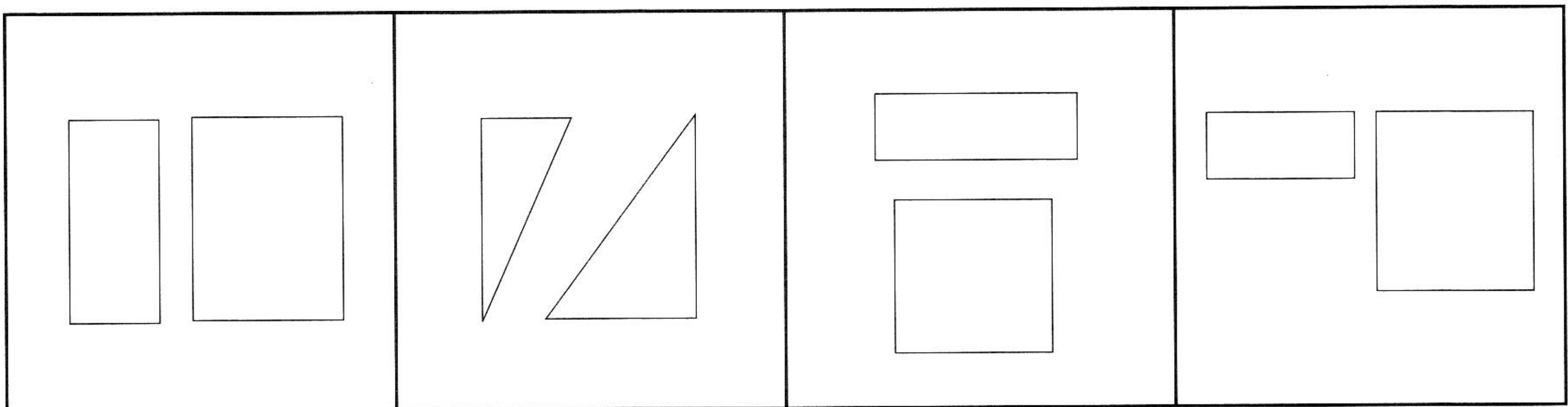
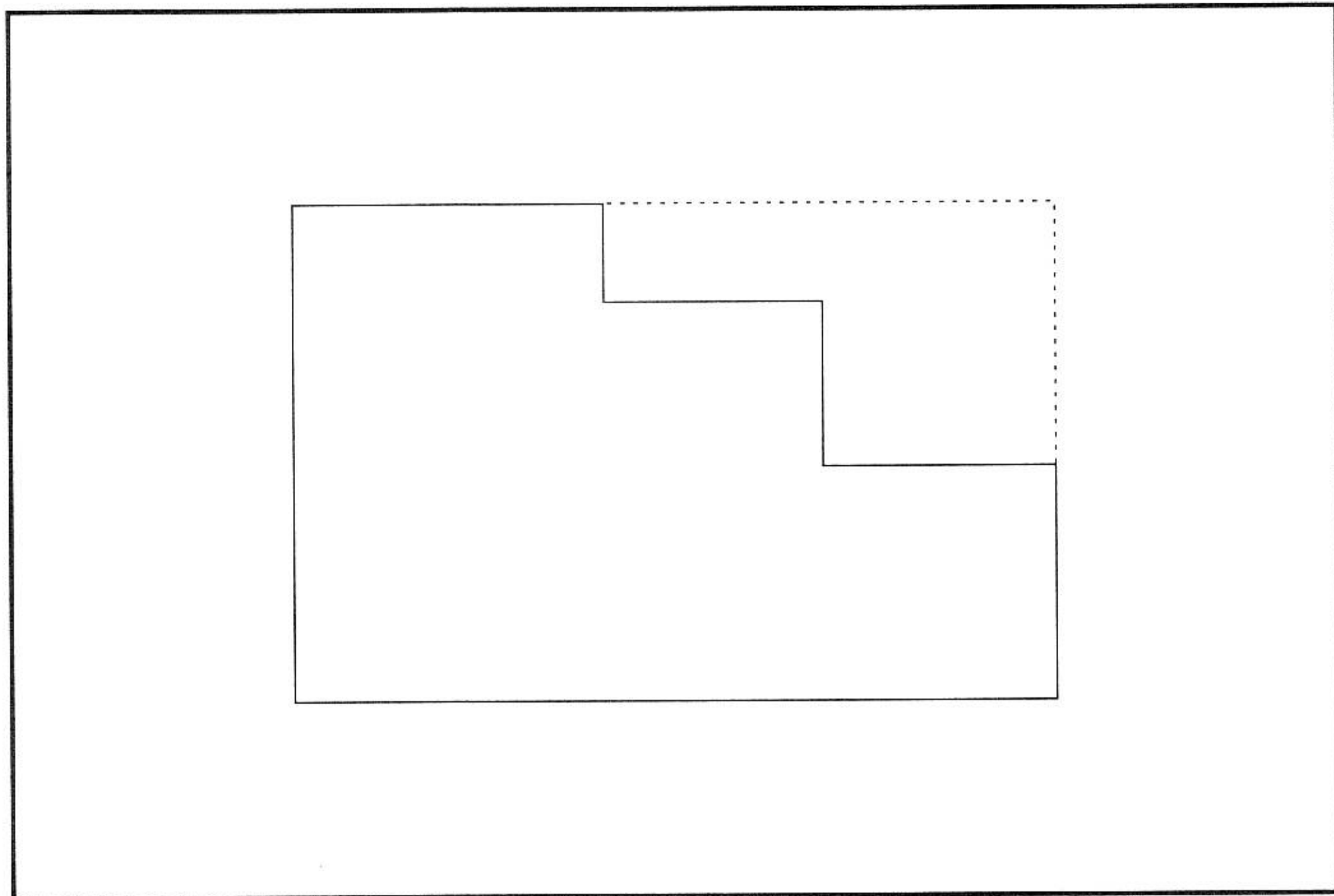

ก

ข

ค

ง

5

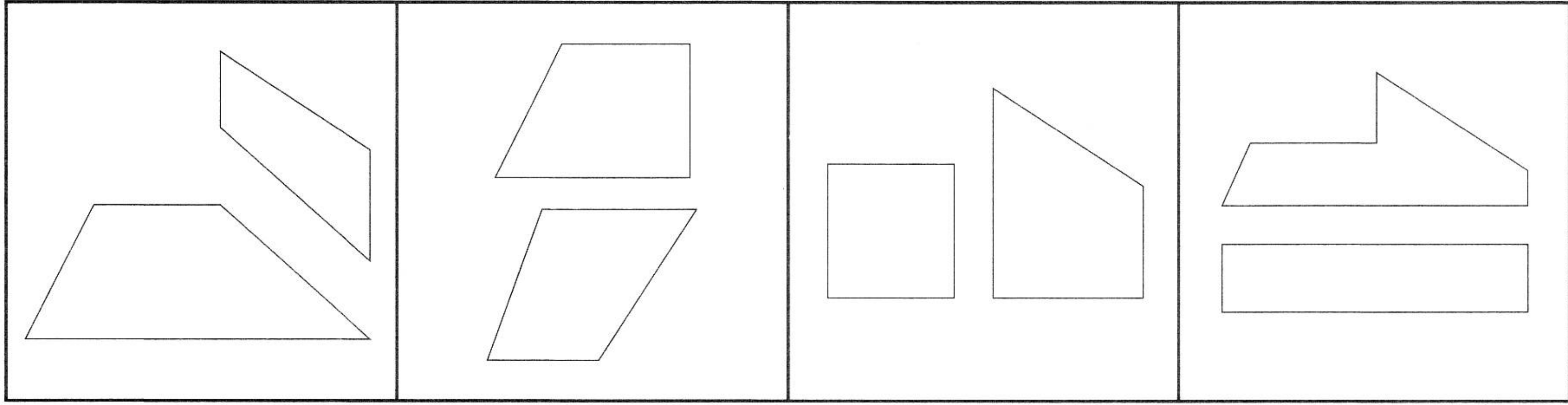
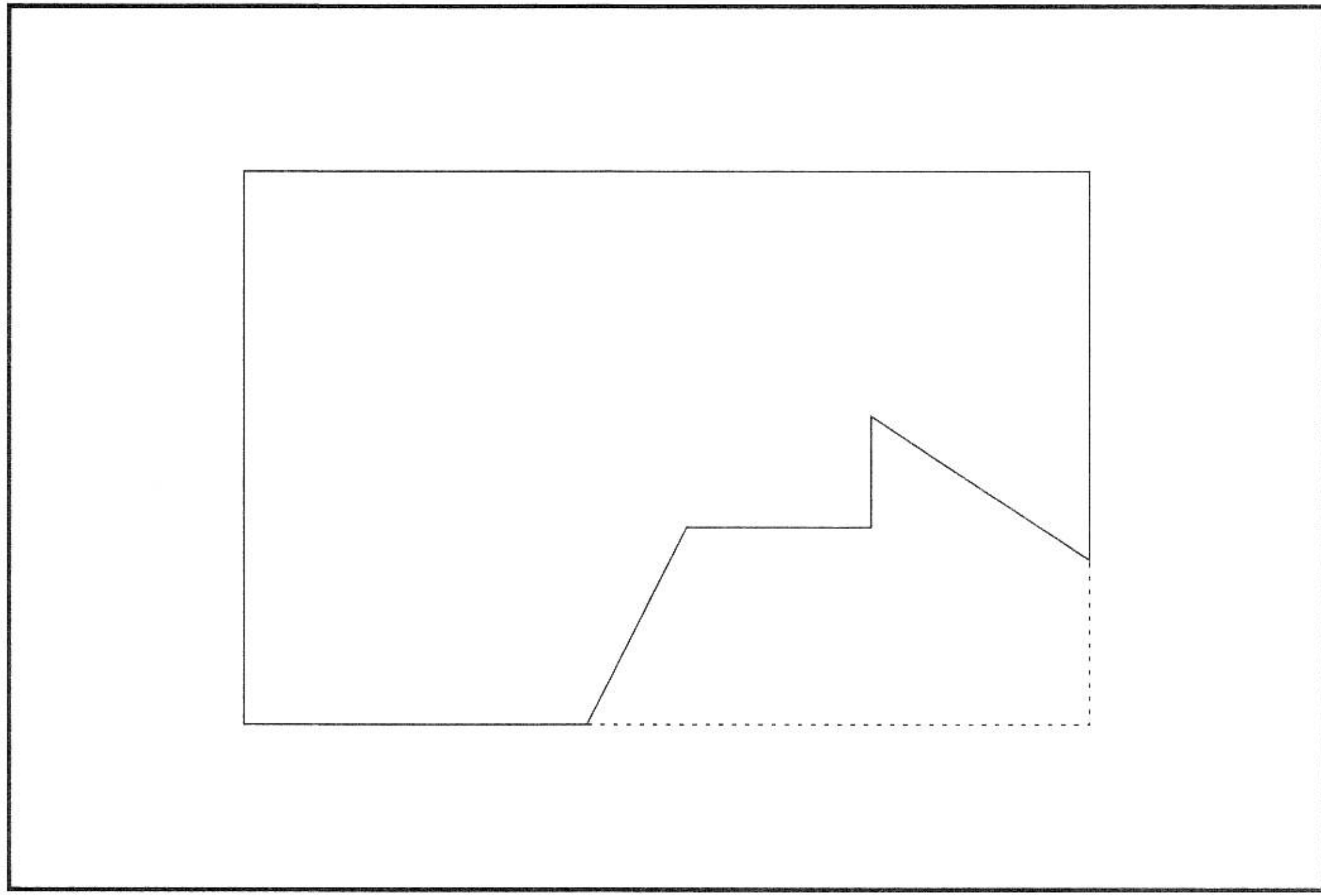

ก

ข

ค

ง

6

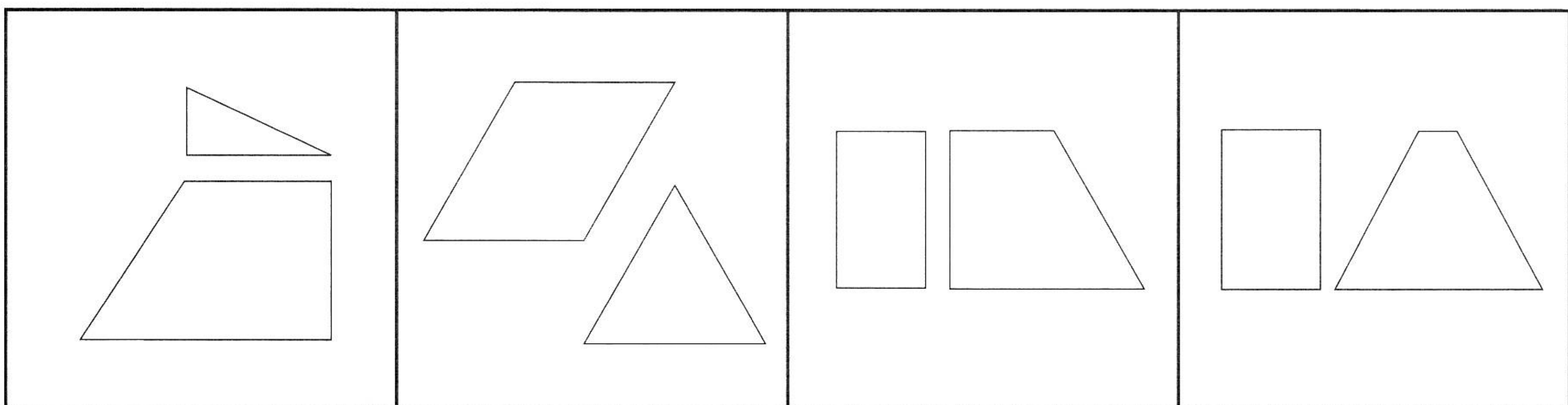
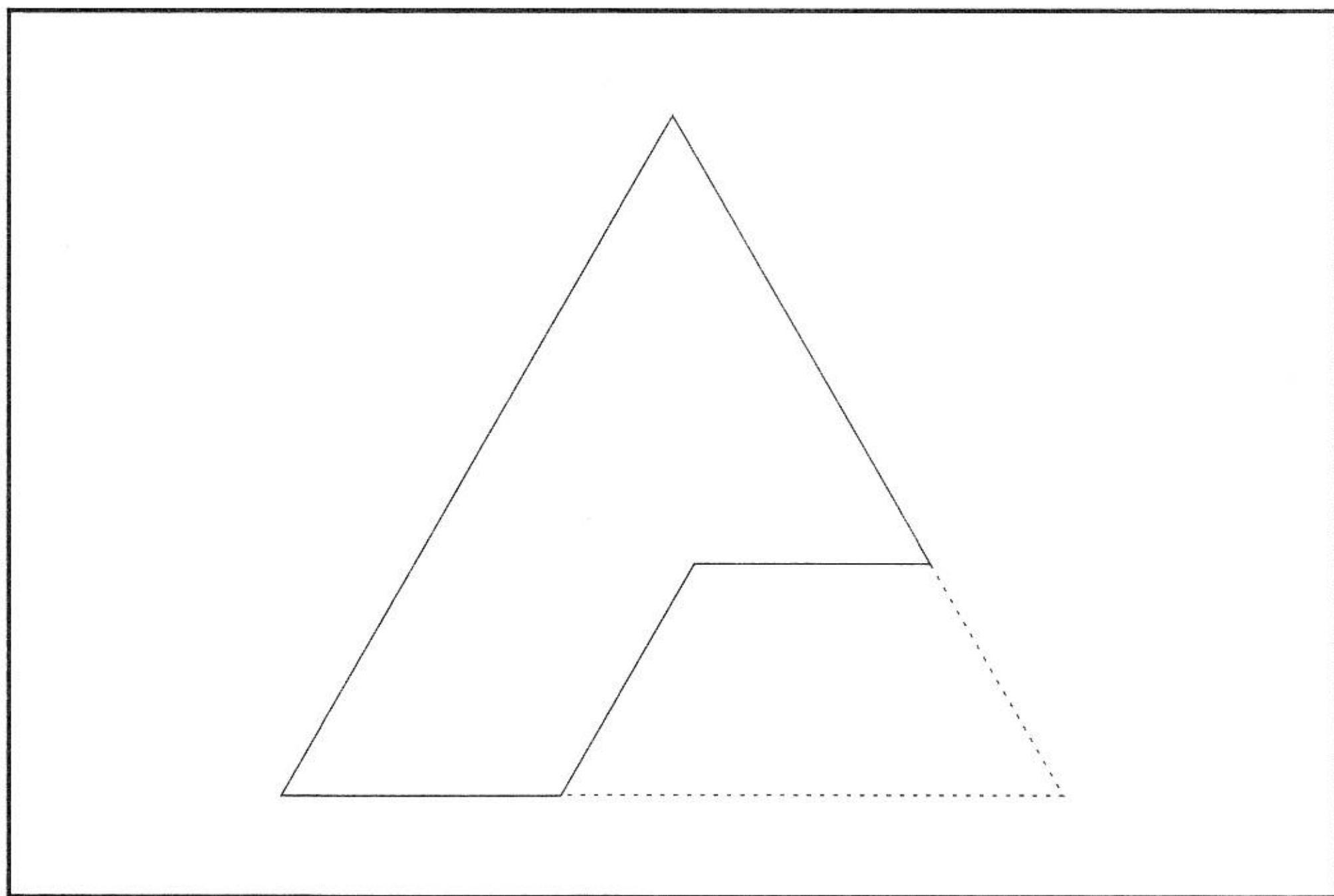

ก

ข

ค

ง

7

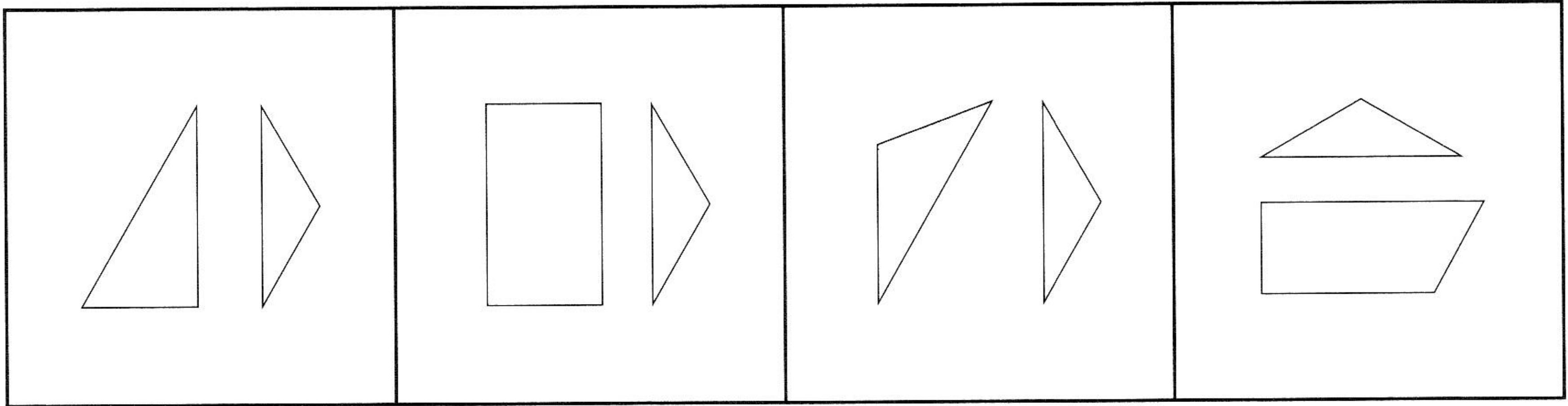
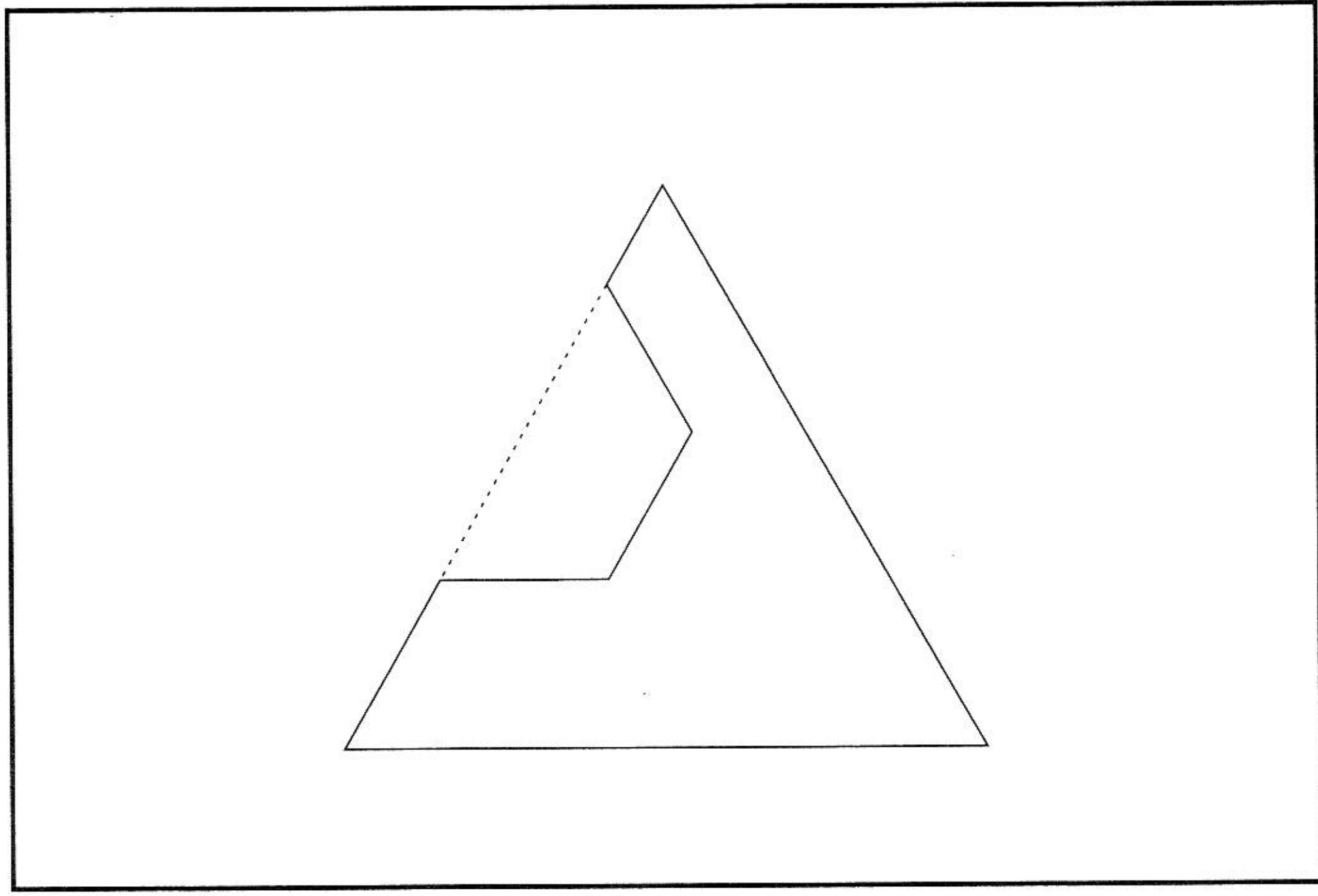

ก

ข

ค

ง

8

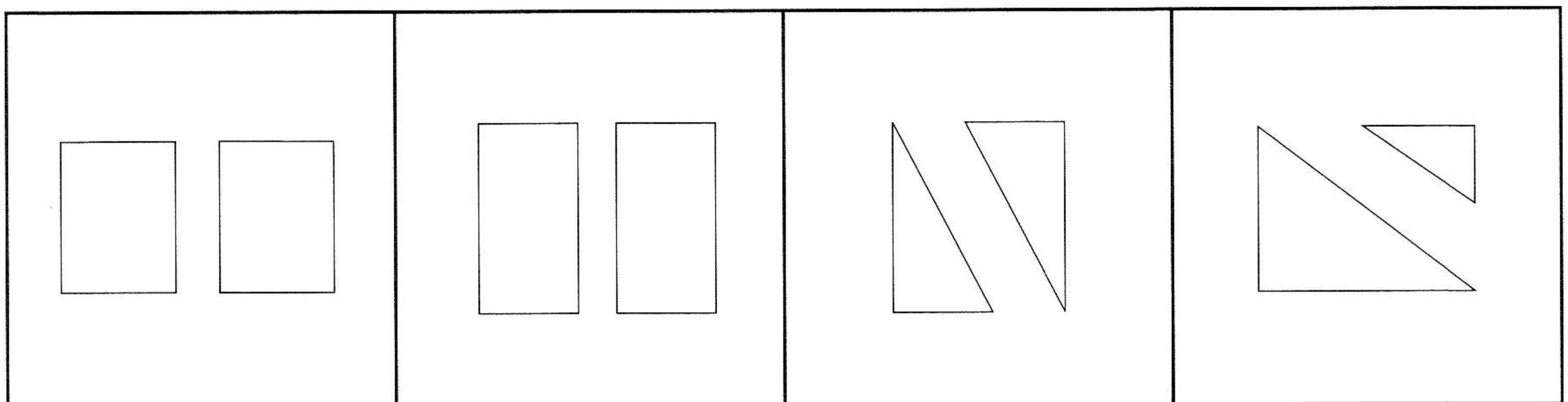
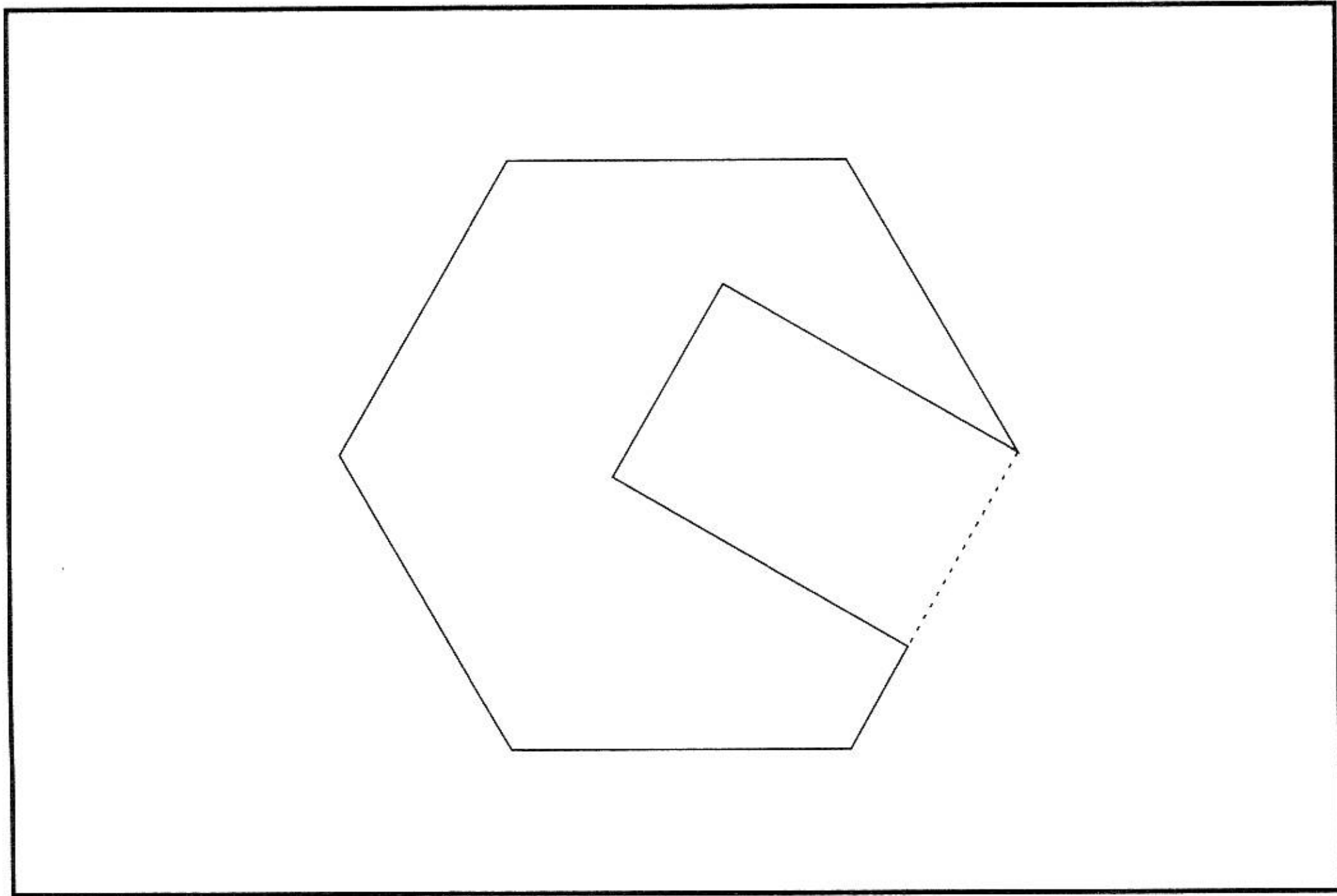

ก

ข

ค

ง

9

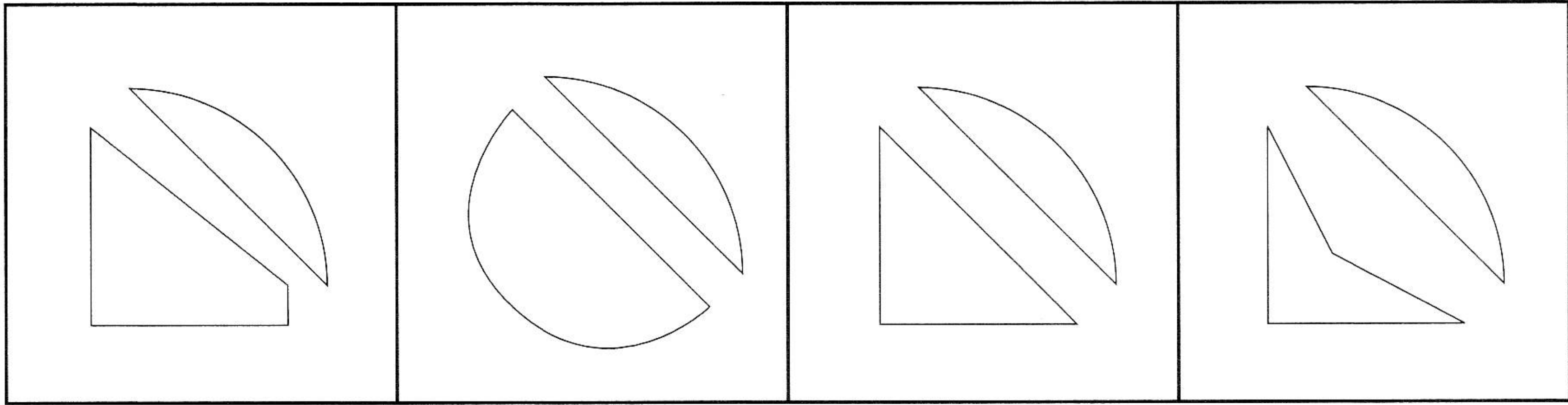
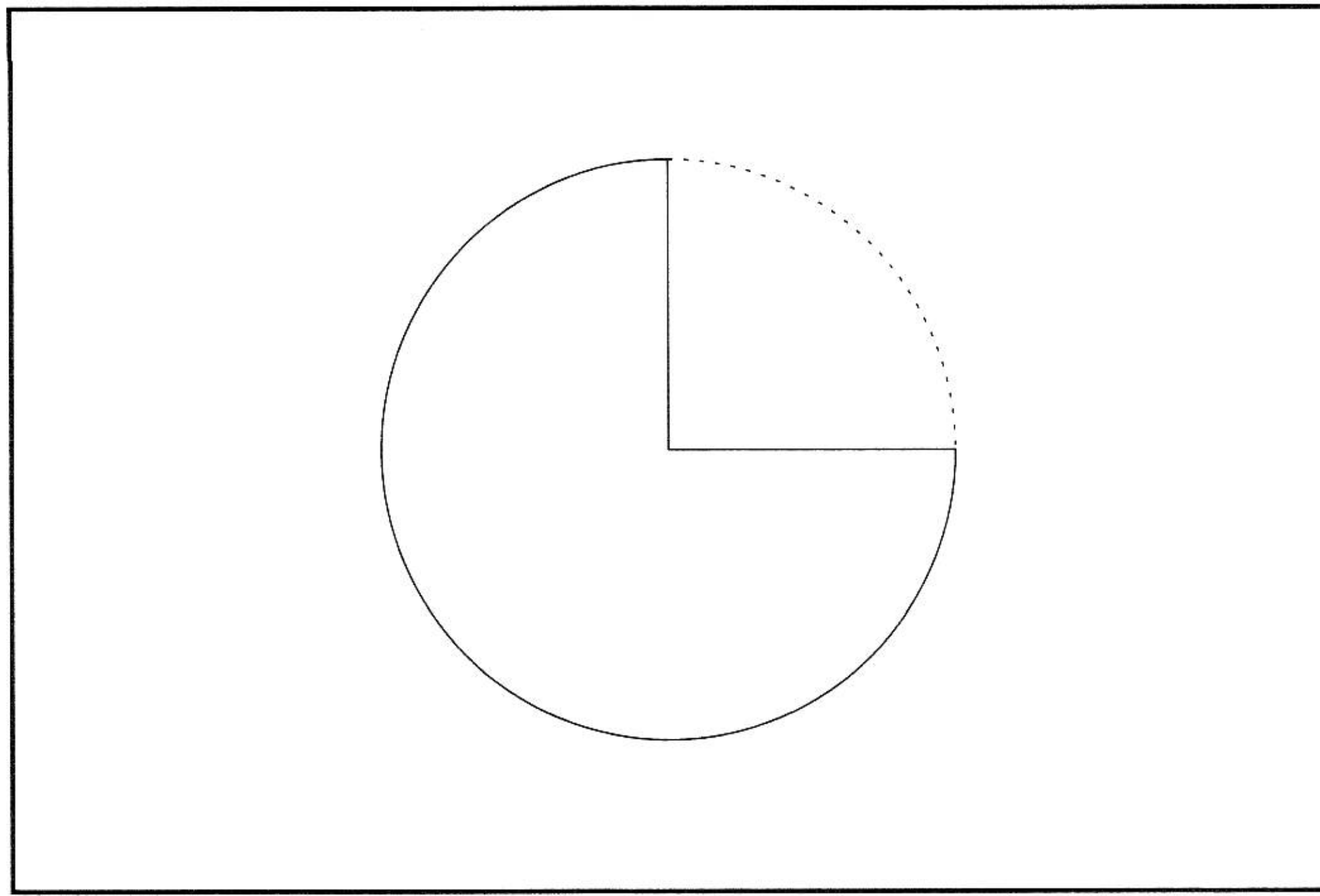

ก

ข

ค

ง

10

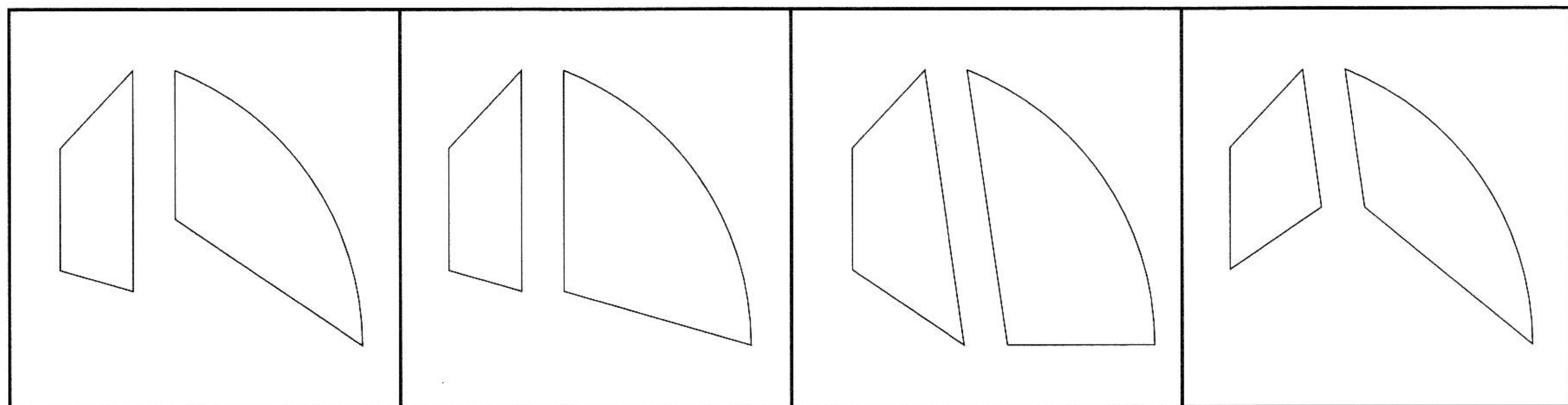
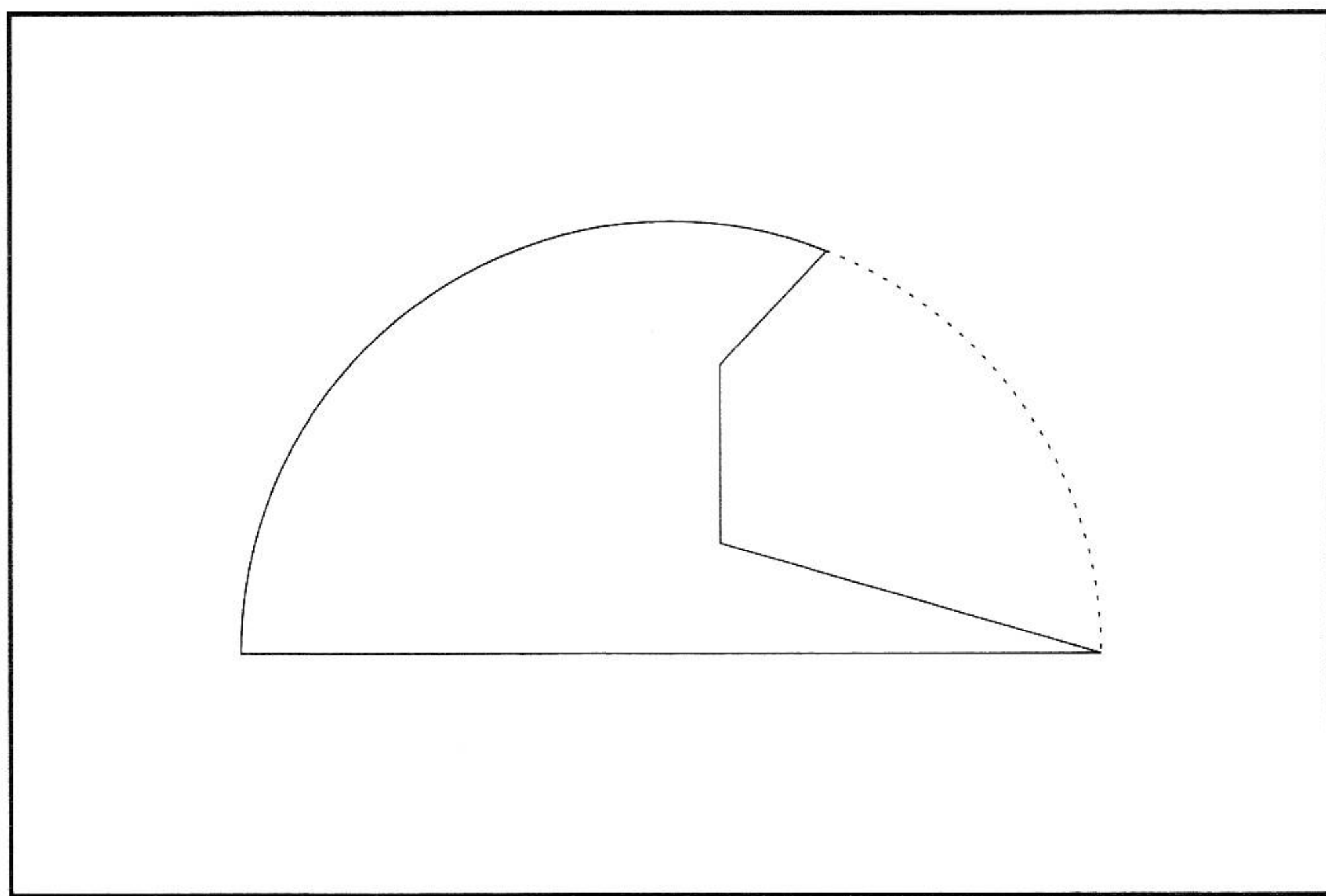

ก

ข

ค

ง

11

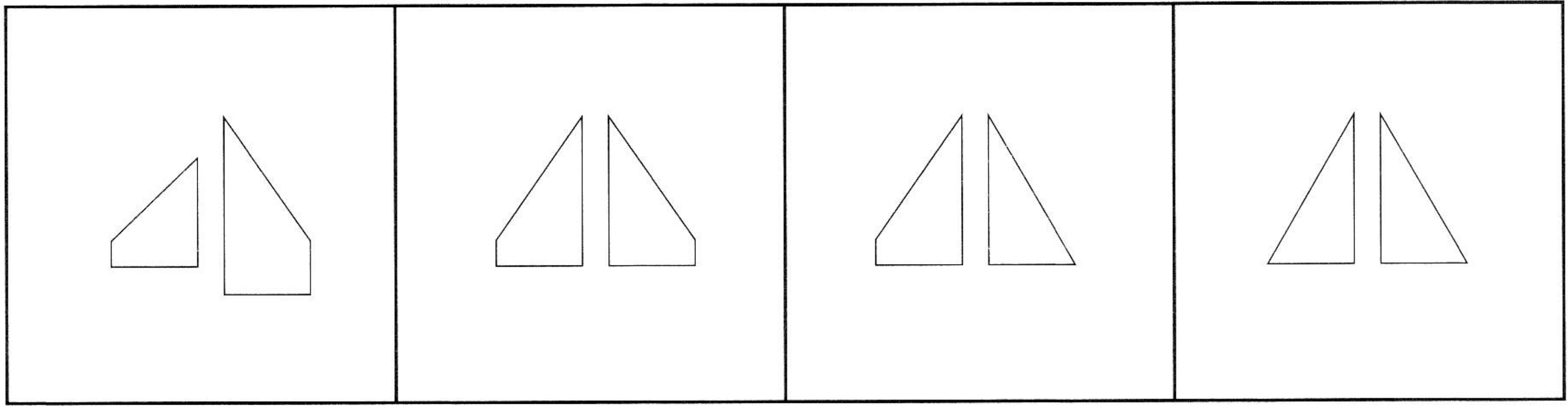
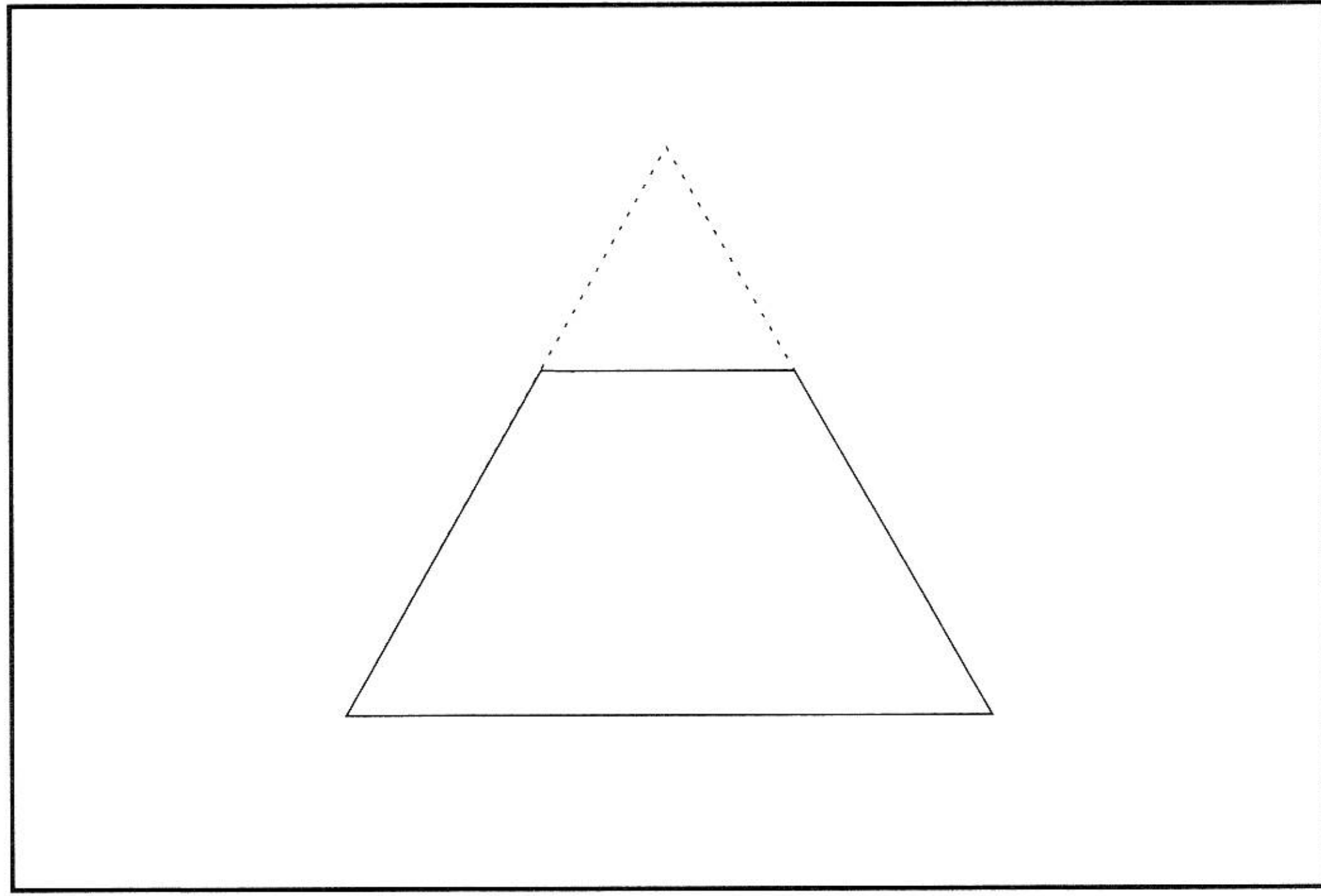

ก

ข

ค

ง

12

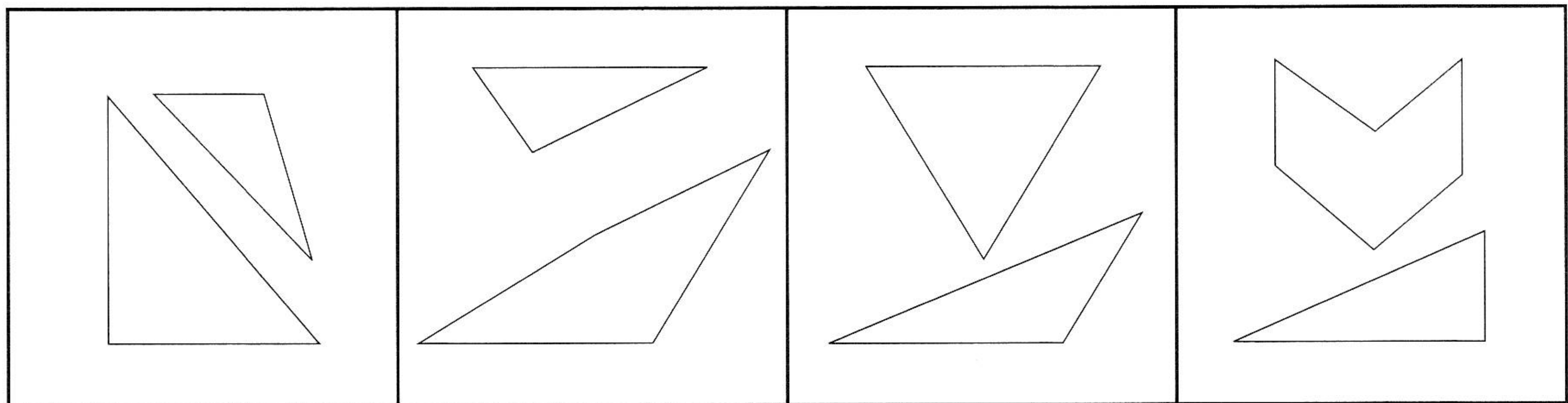
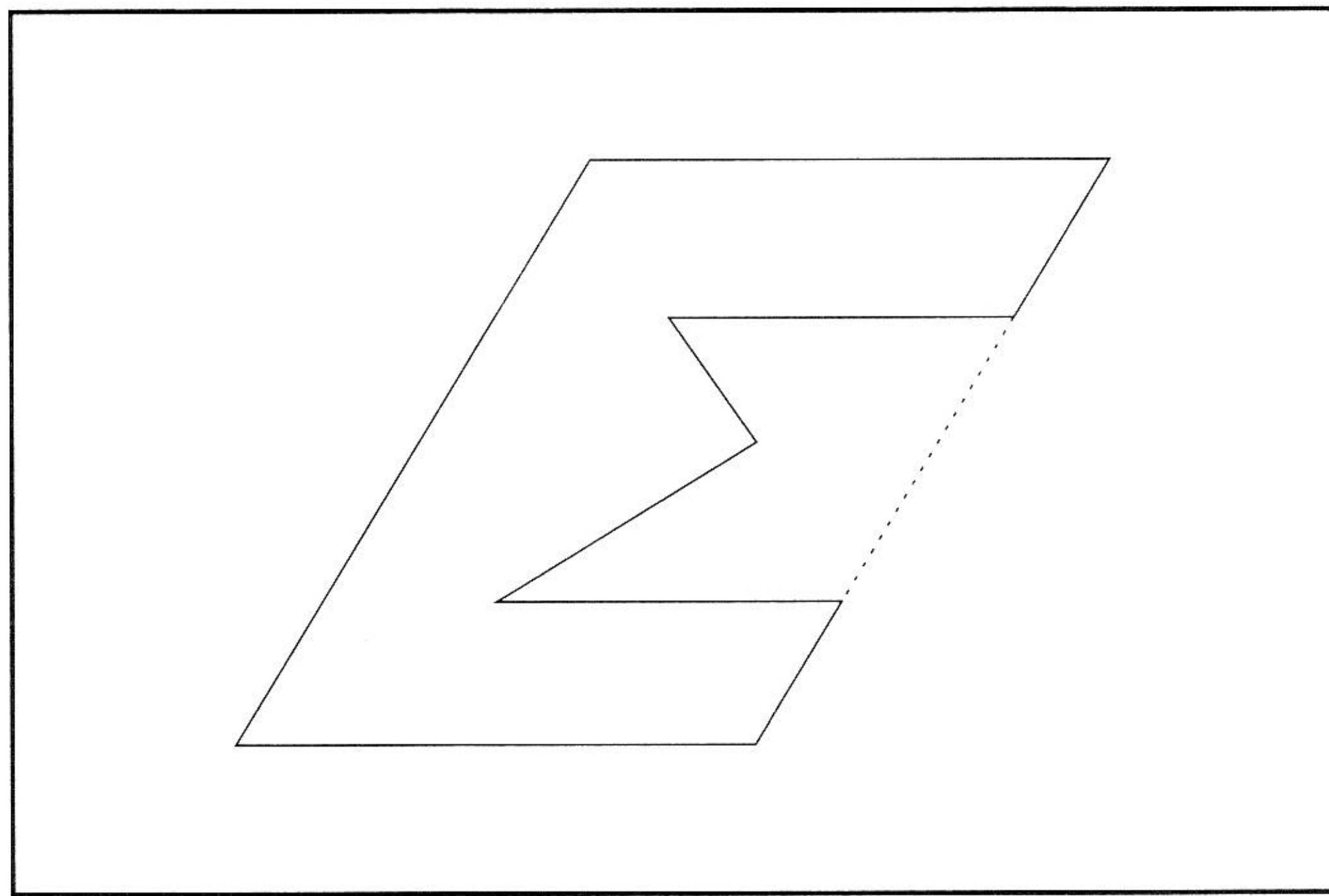

ก

ข

ค

ง

13

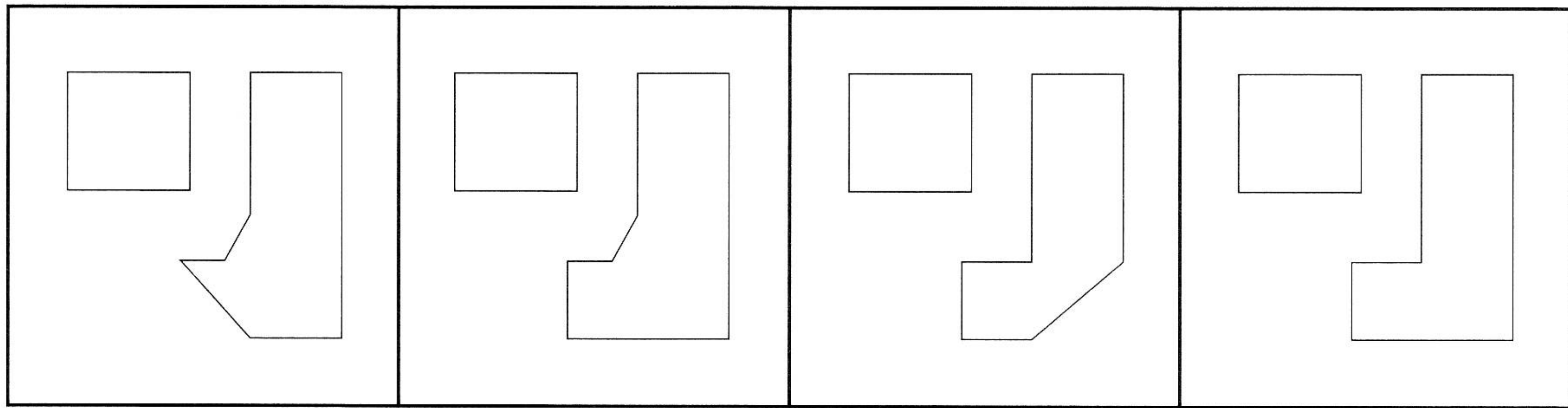
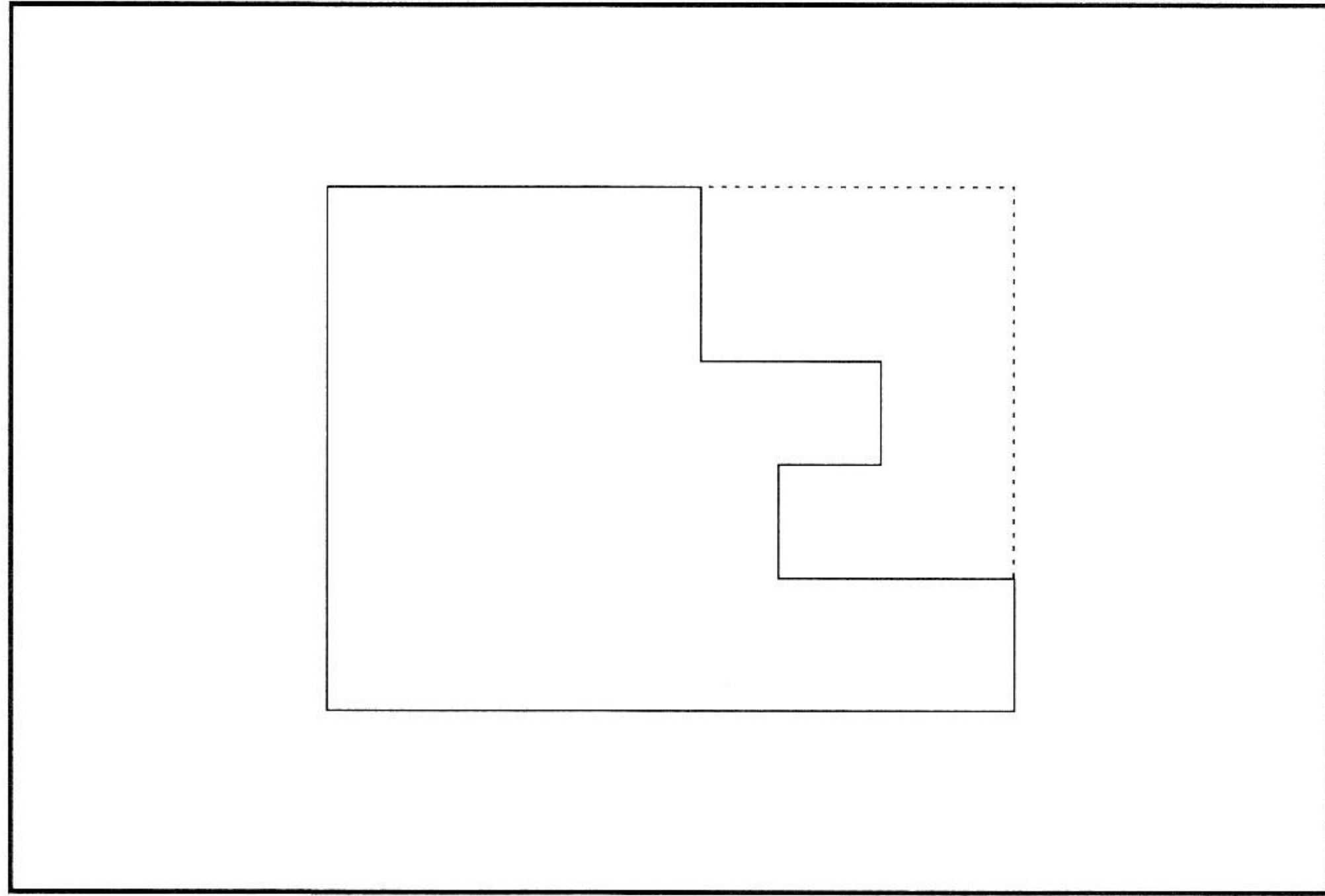

ก

ข

ค

ง

14

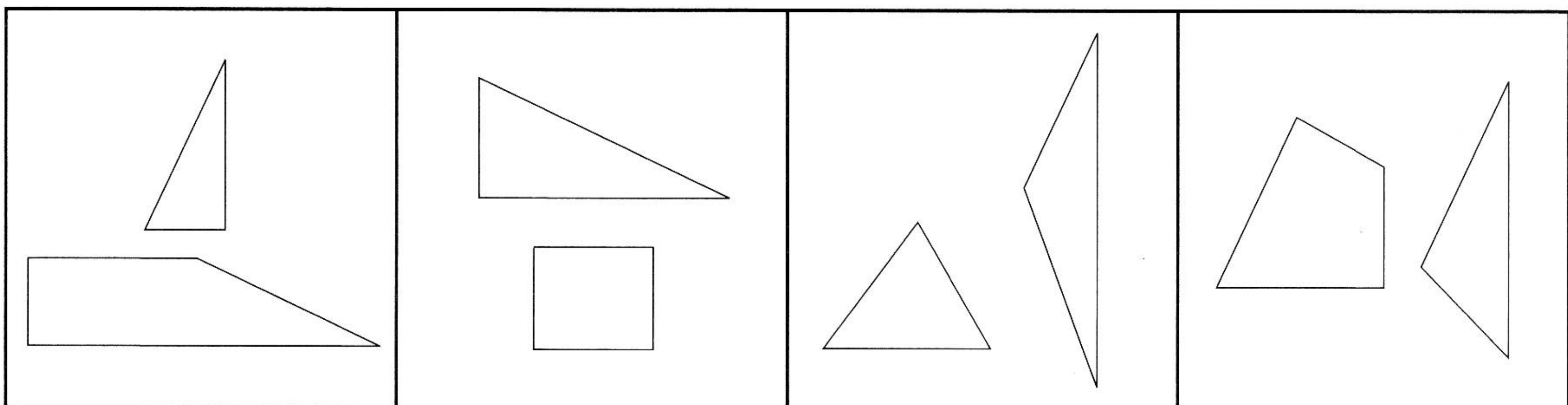
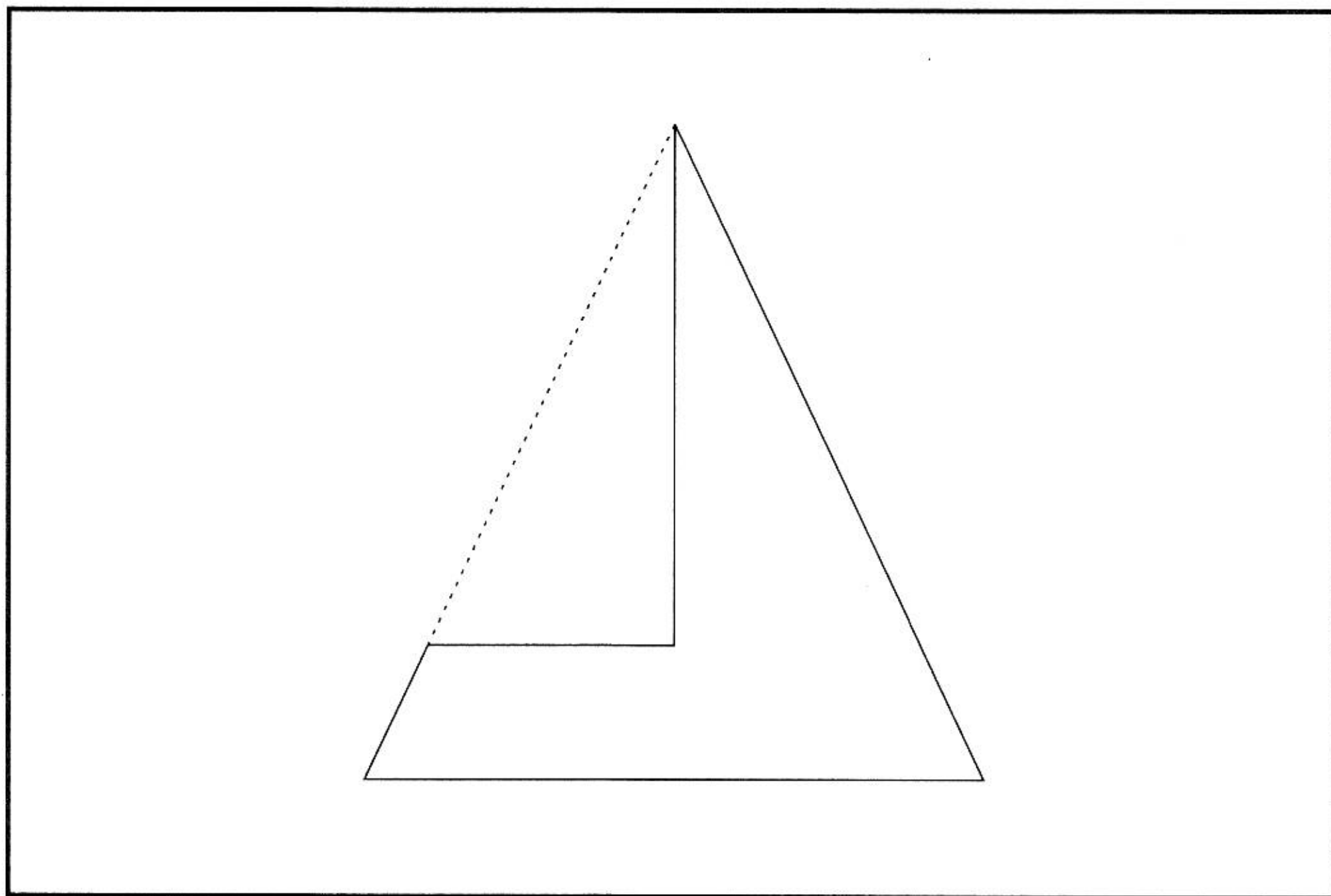

ก

ข

ค

ง

15

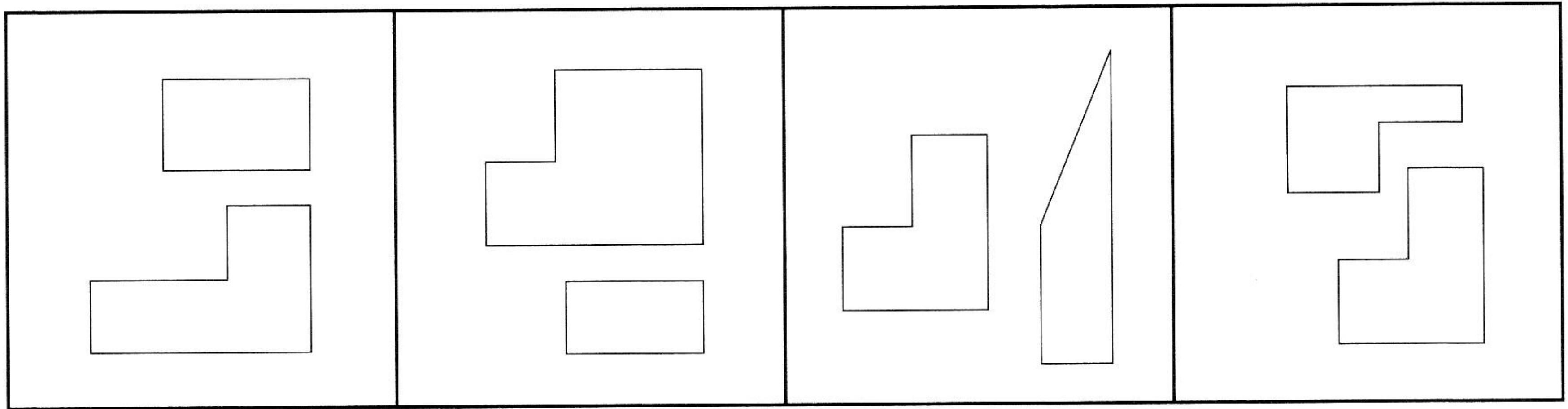
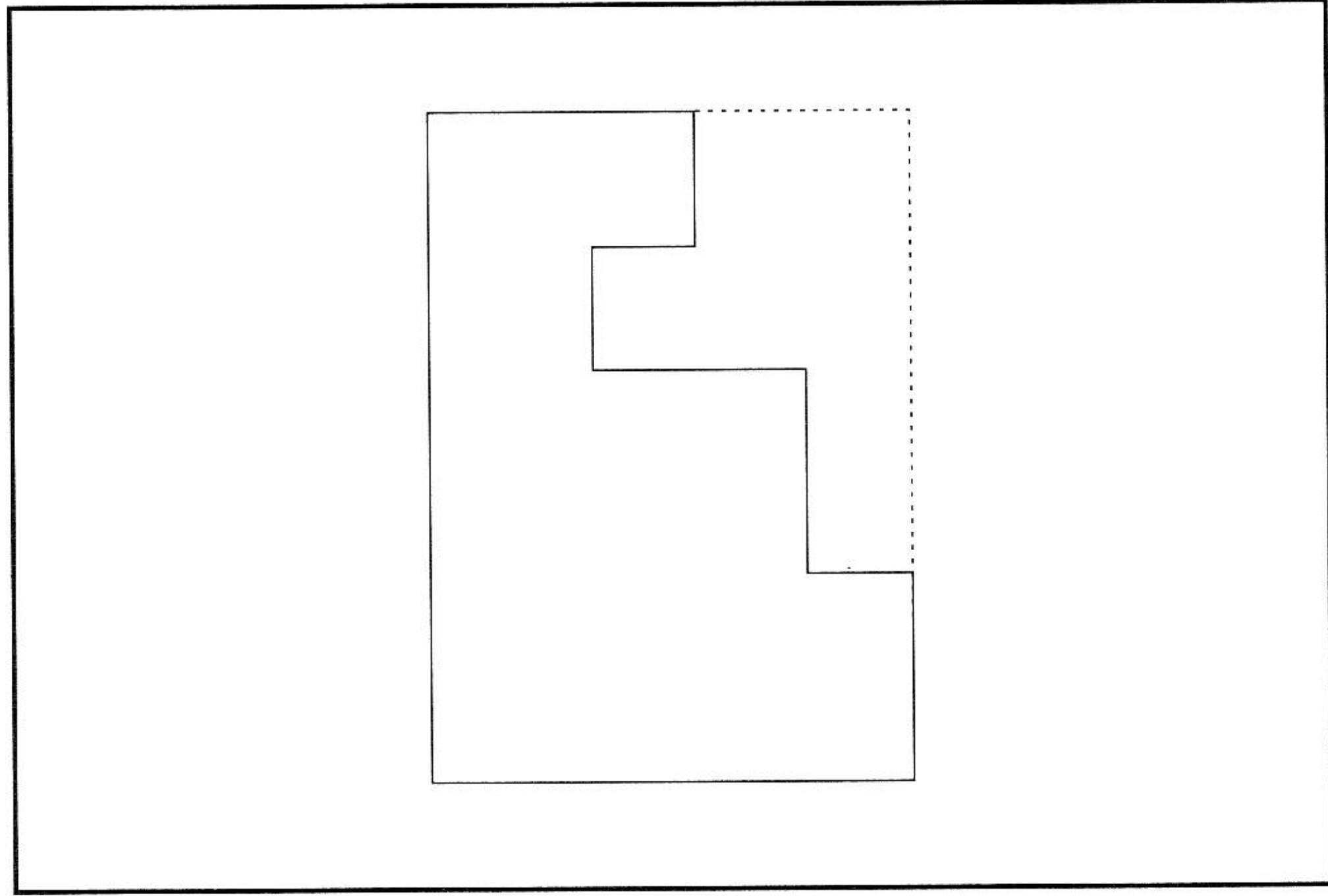

ก

ข

ค

ง

16

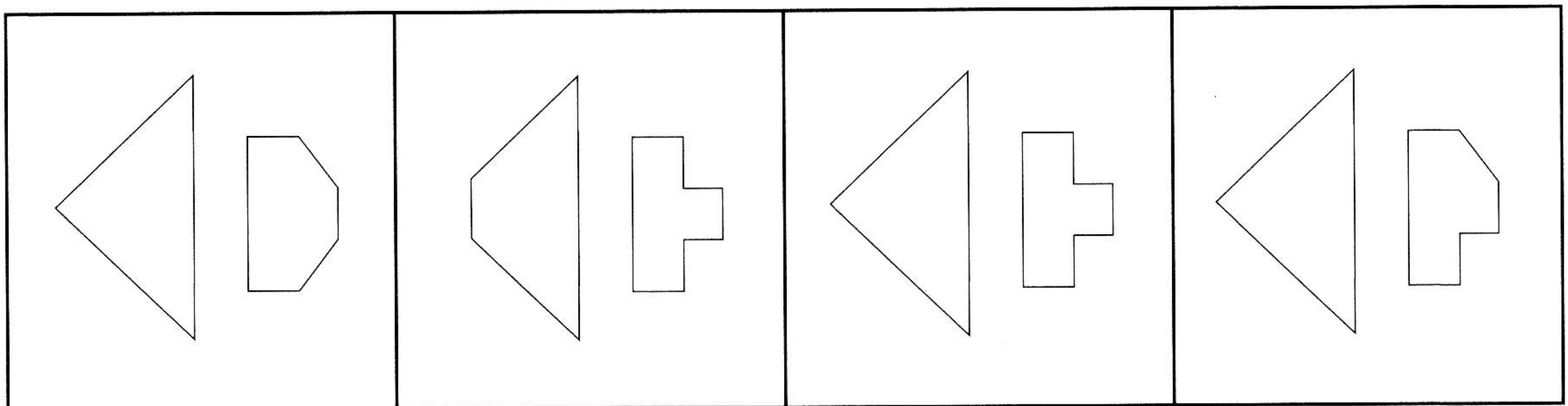
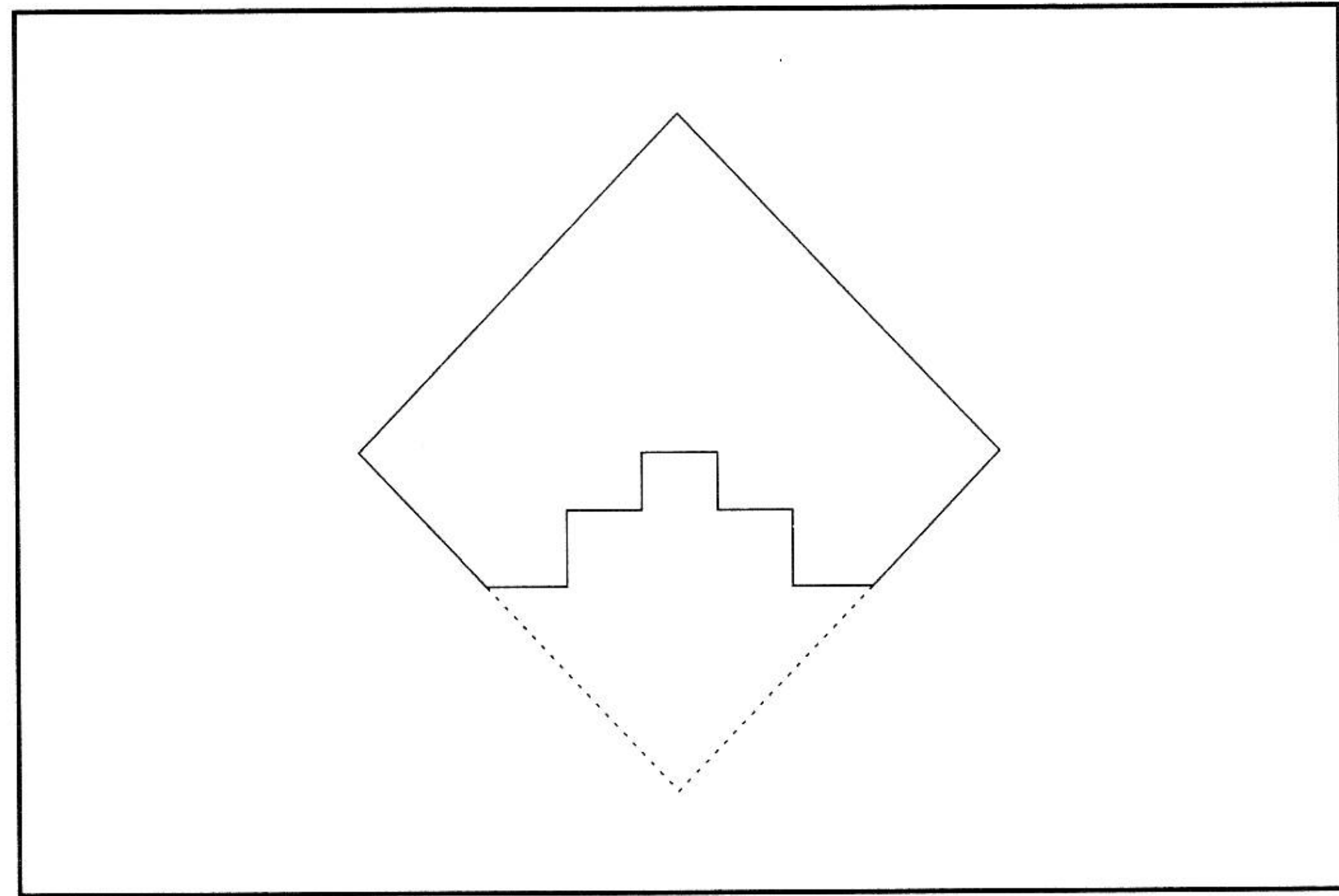

ก

ข

ค

ง

17

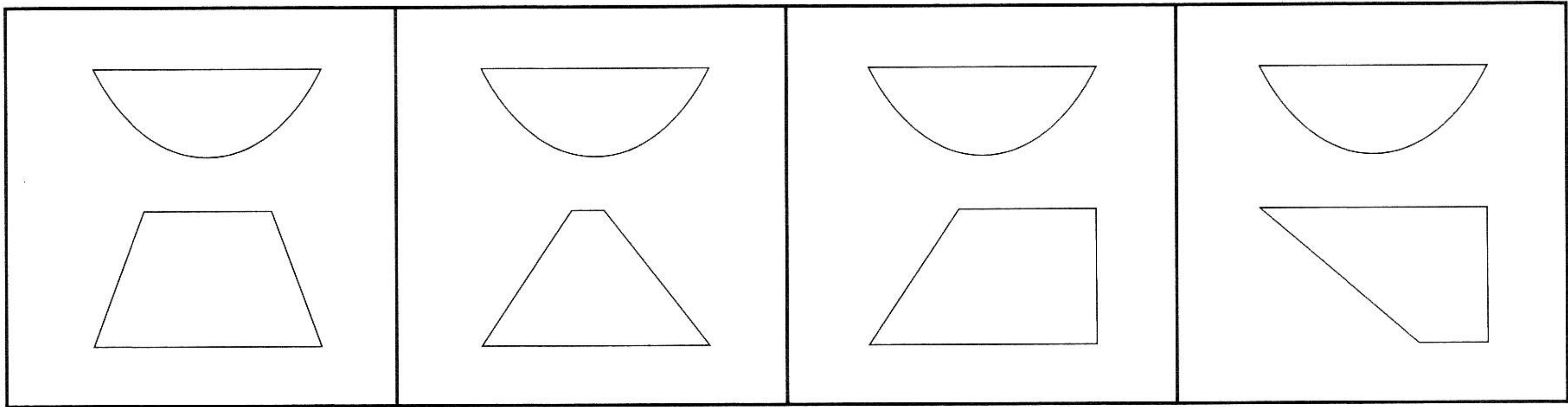
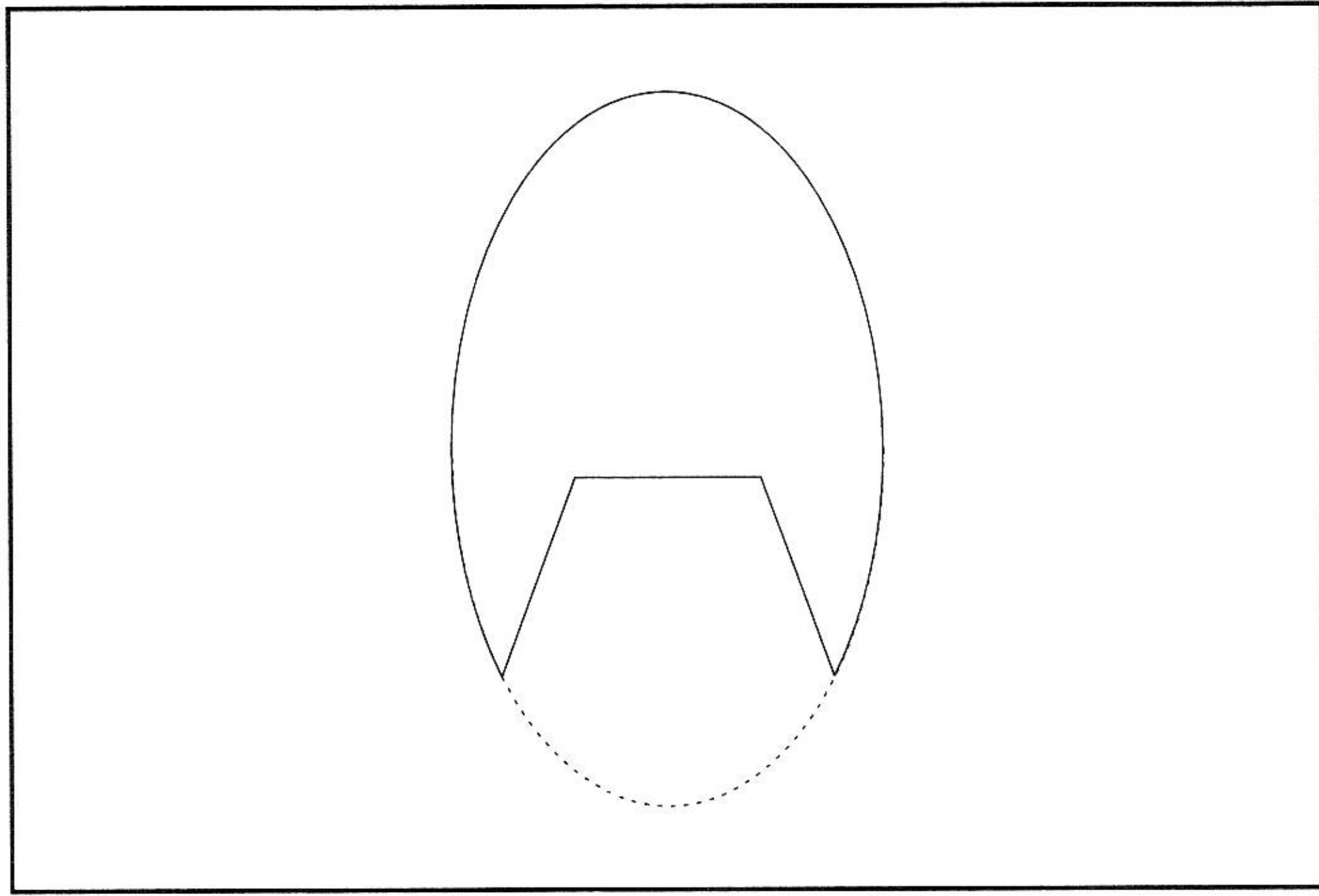

ก

ข

ค

ง

18

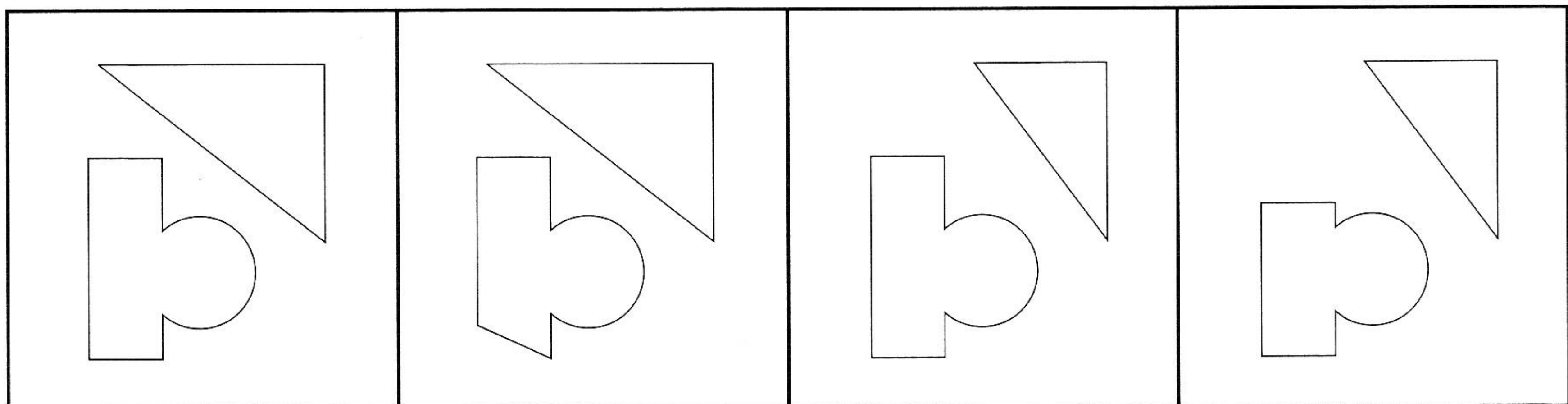
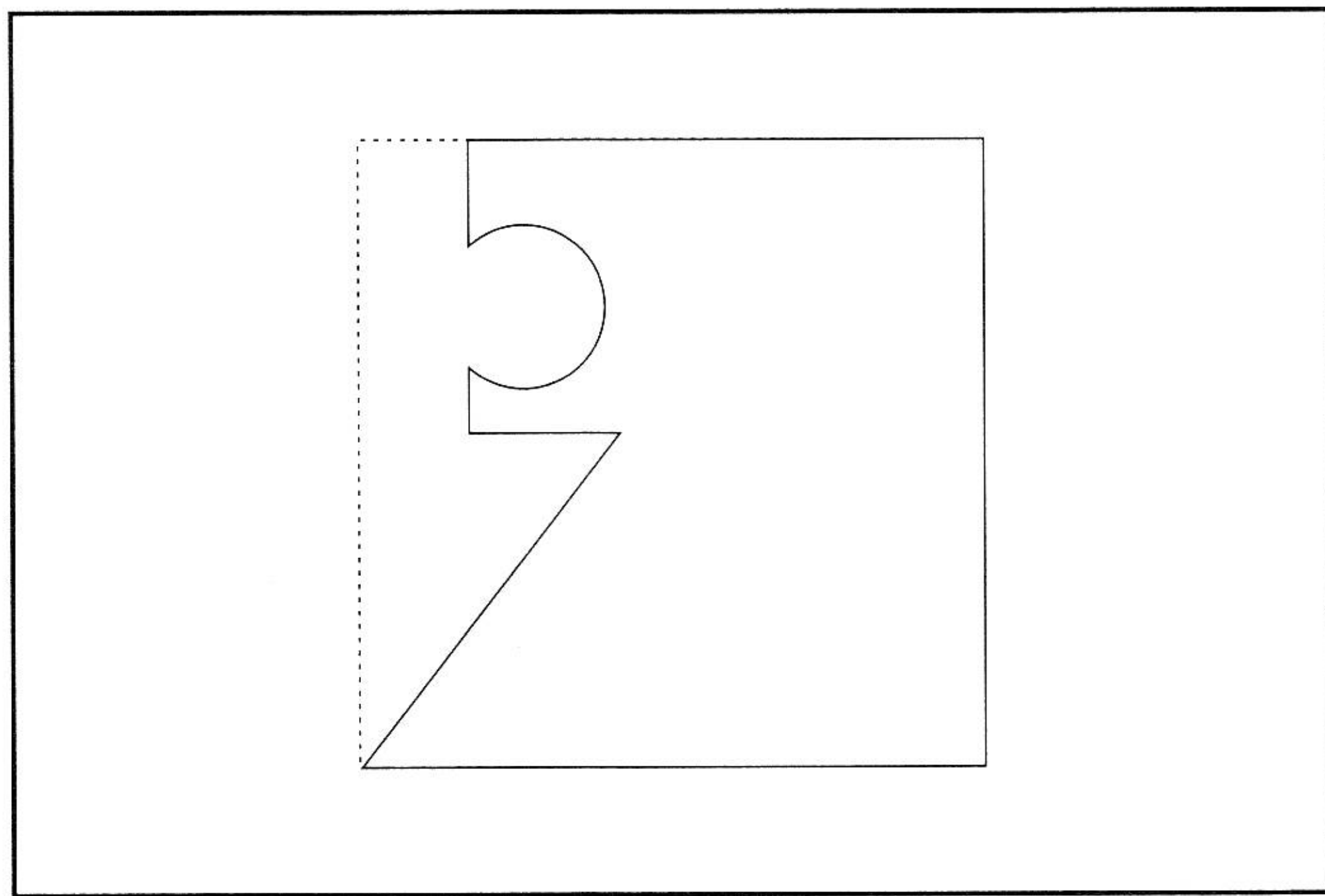

ก

ข

ค

ง

19

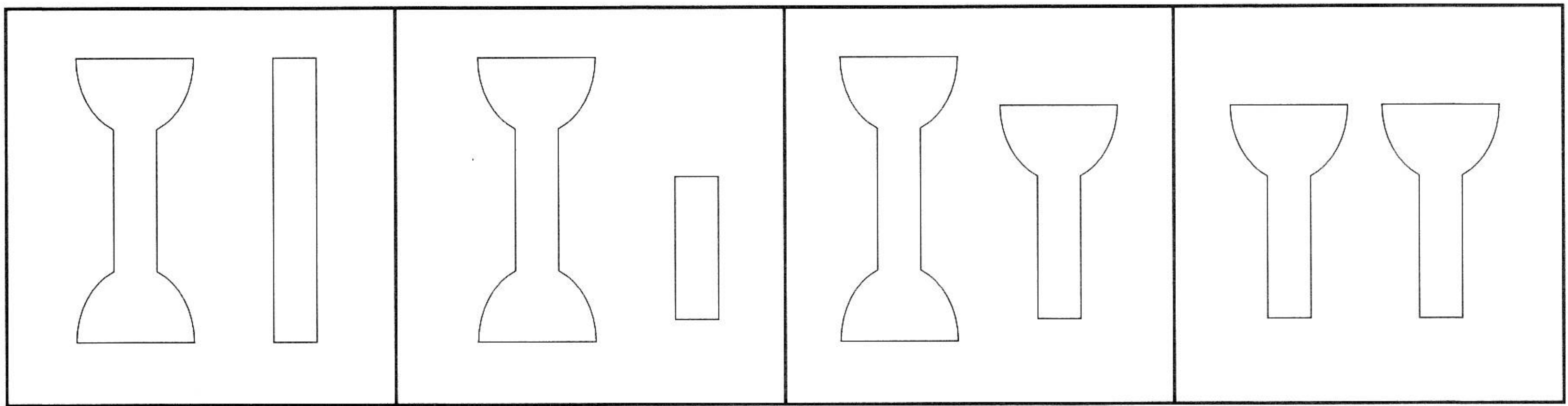
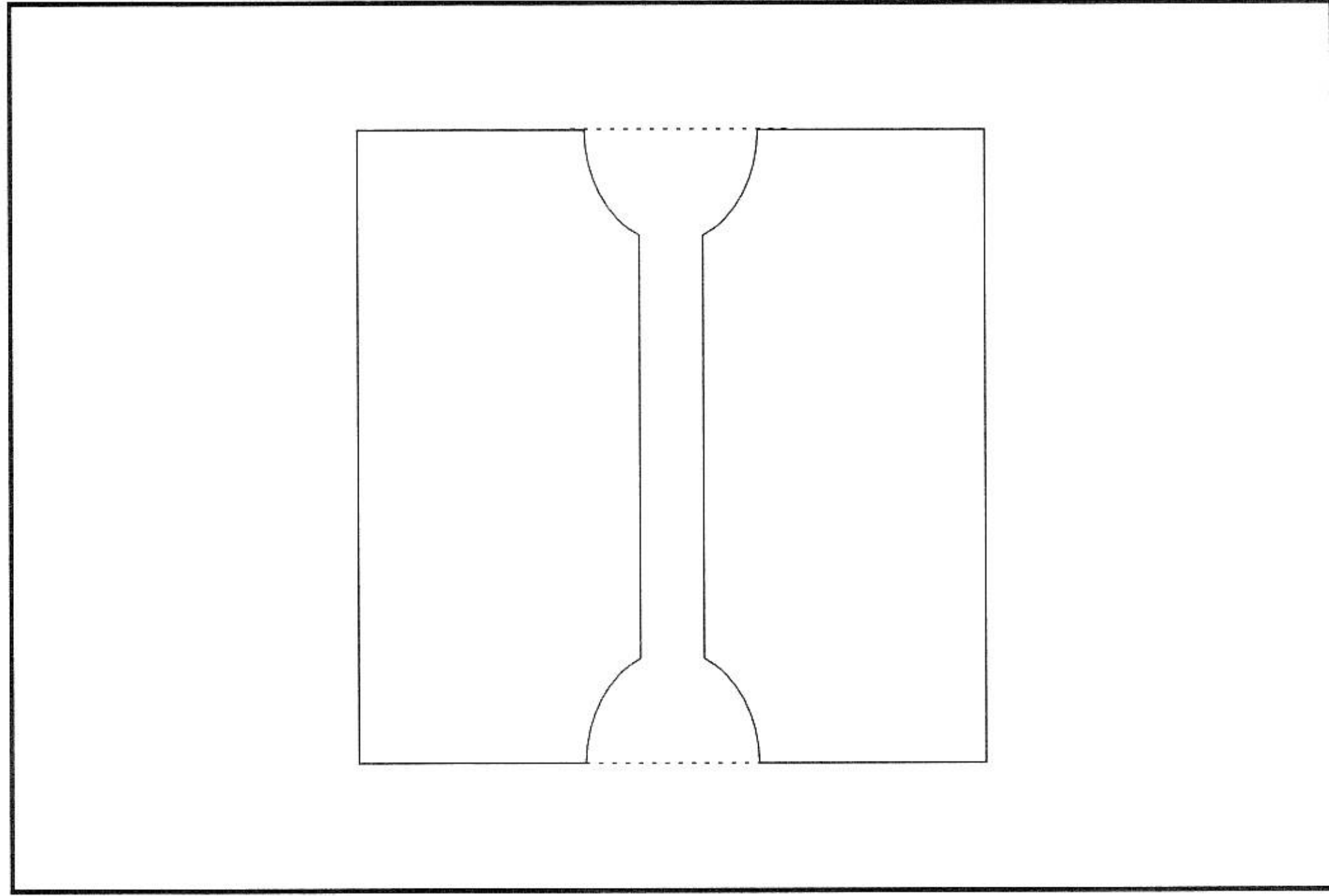

ก

ข

ค

ง

20

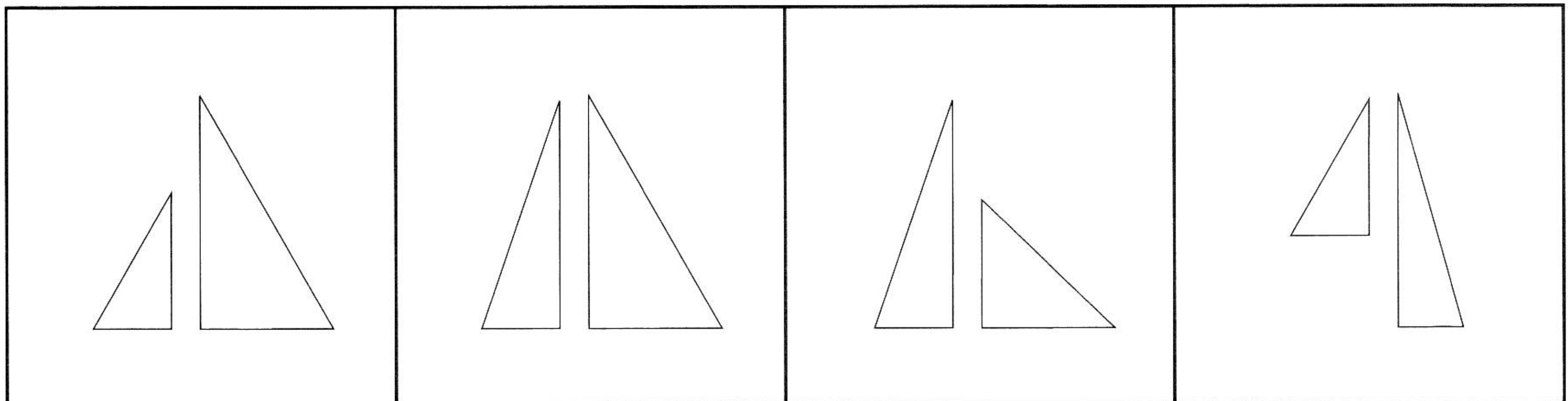
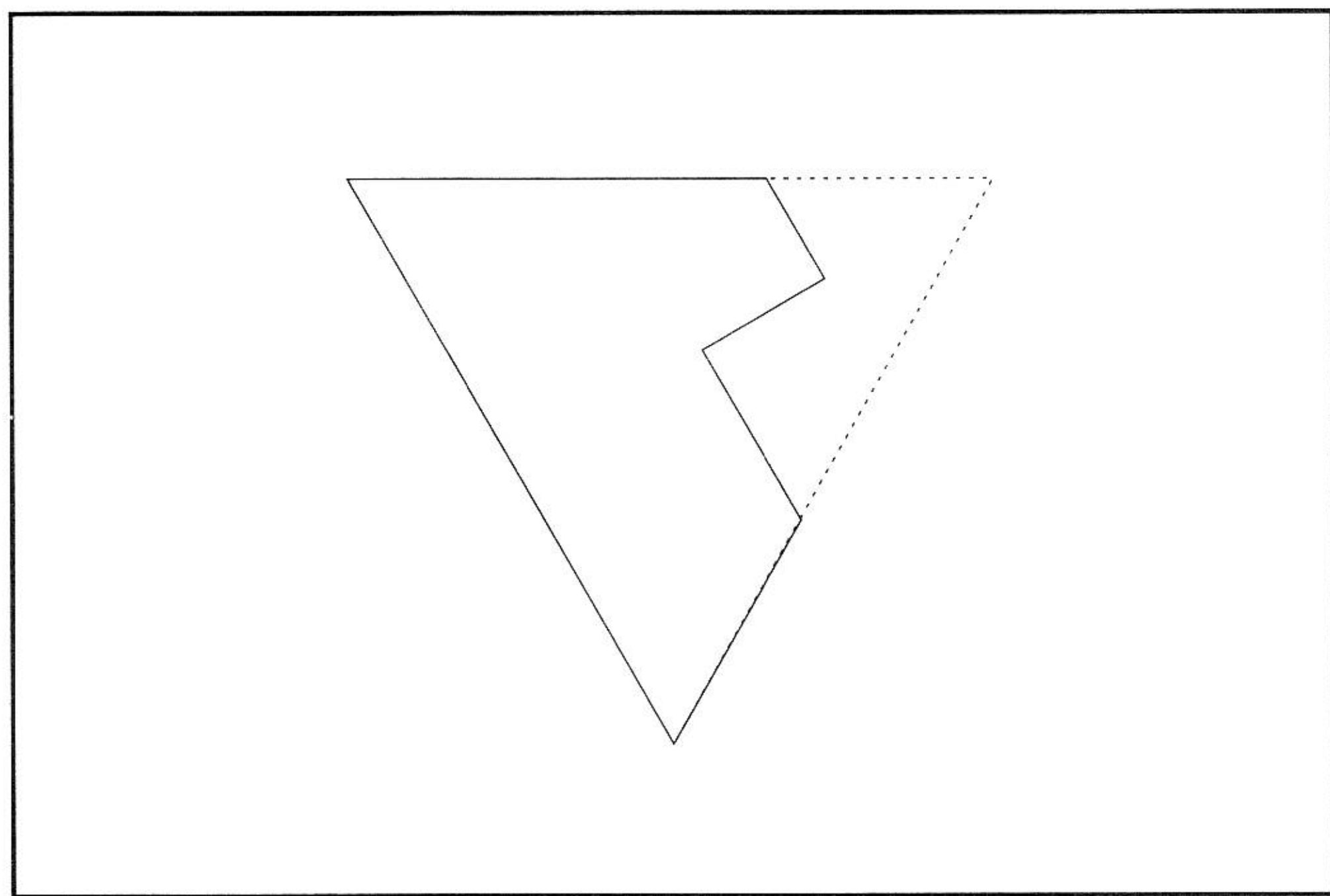

ก

ข

ค

ง

จงขีด ✓ ข้อที่เป็นรูปเต็มของภาพแรกเมื่อกางกระดาษ

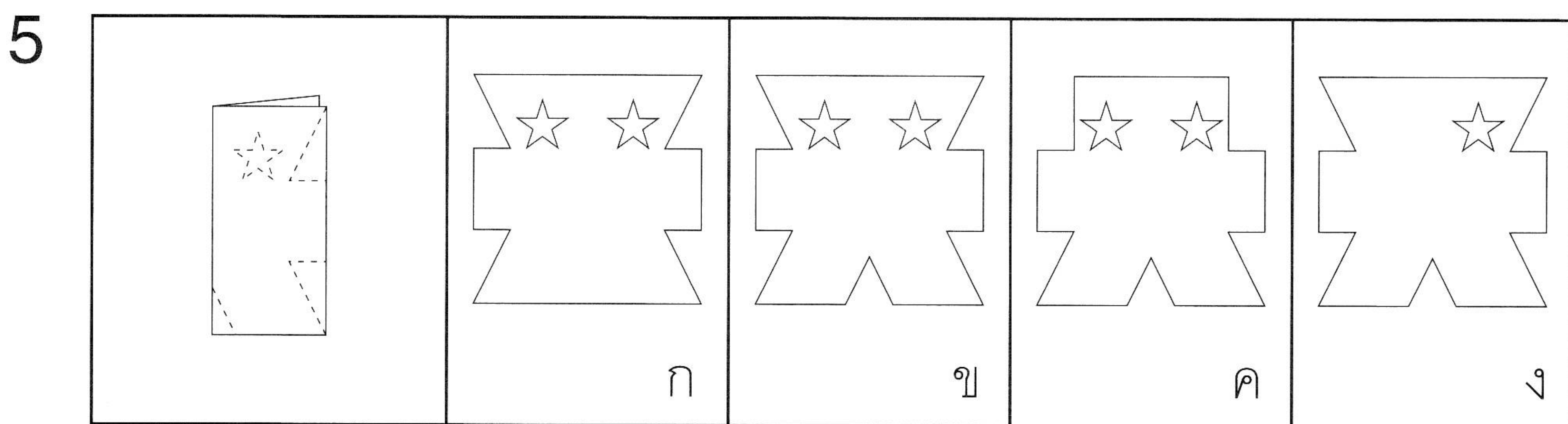
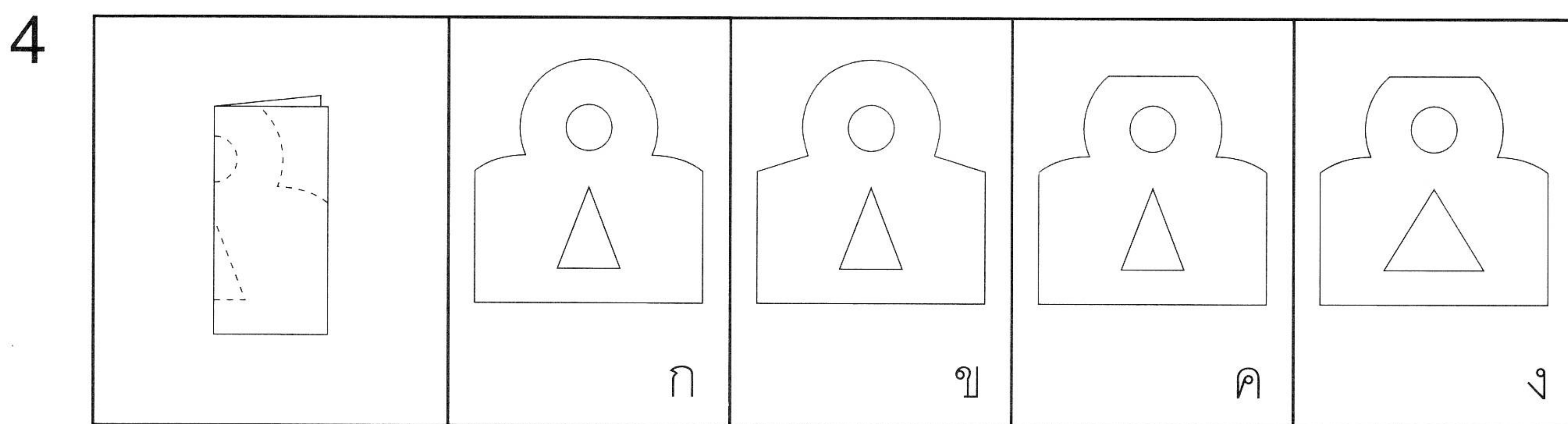
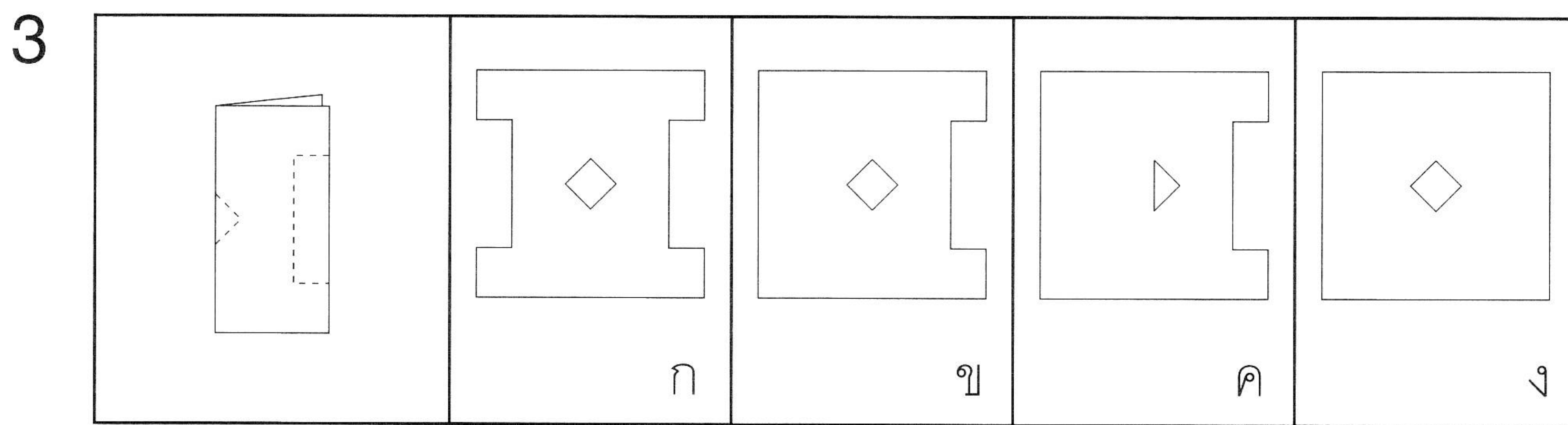
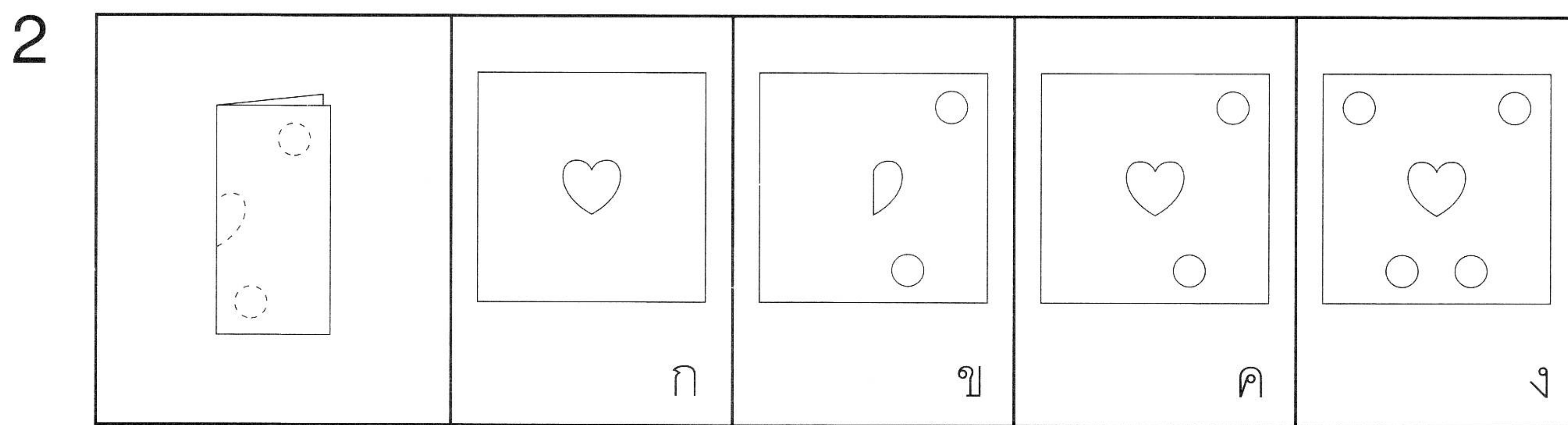
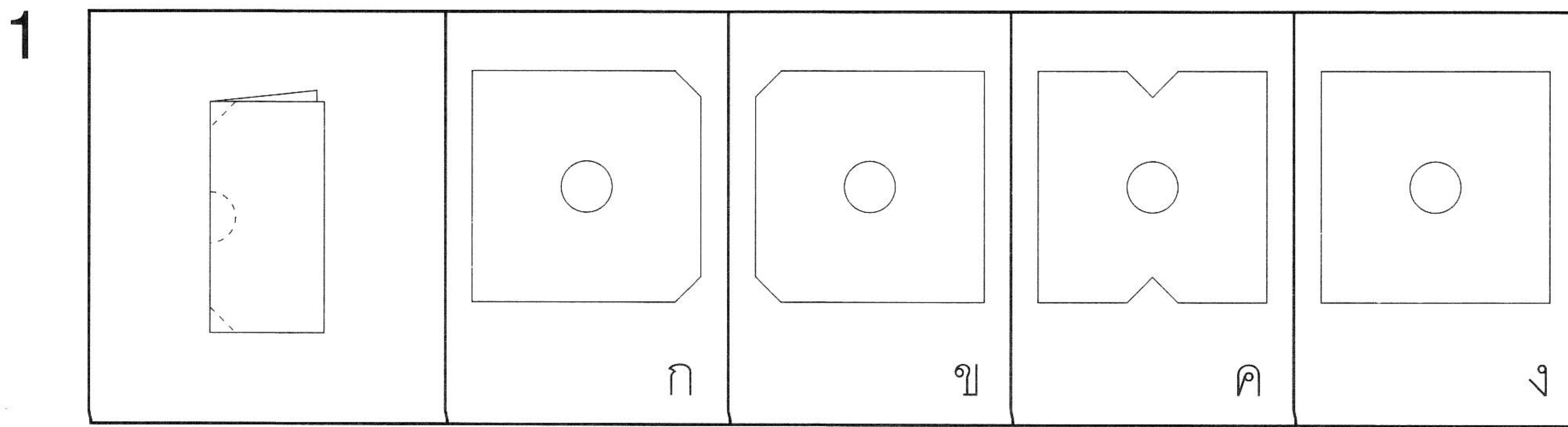

6

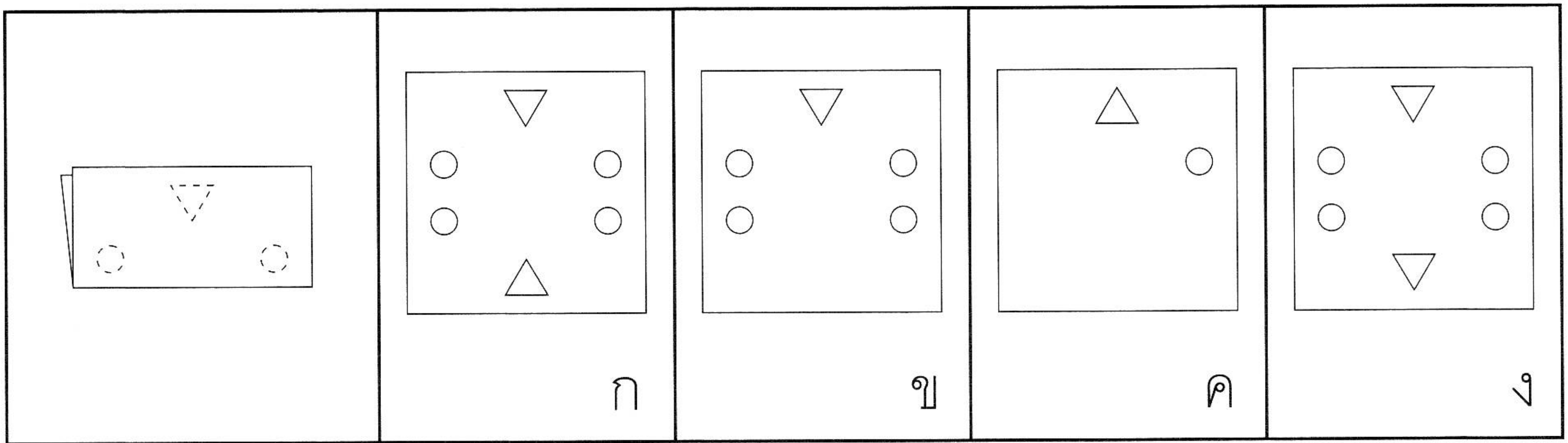

7

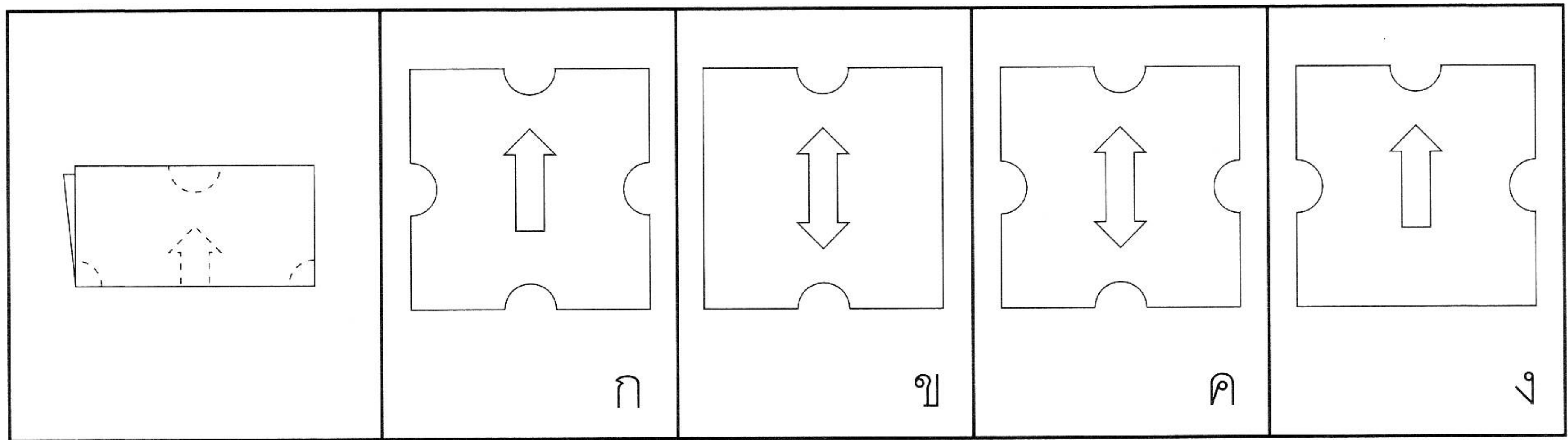

8

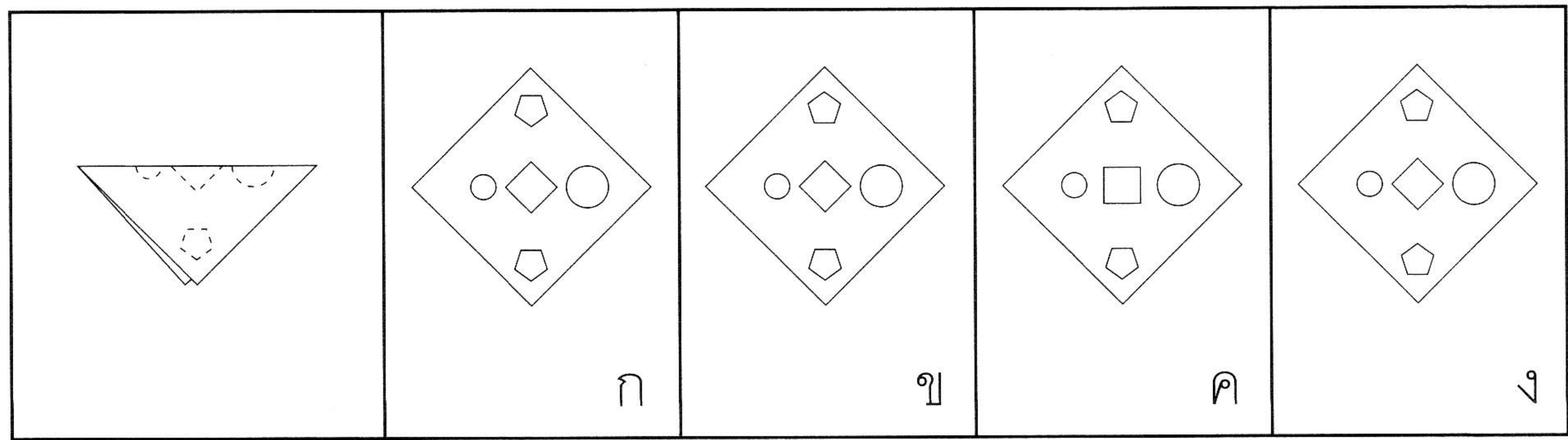

9

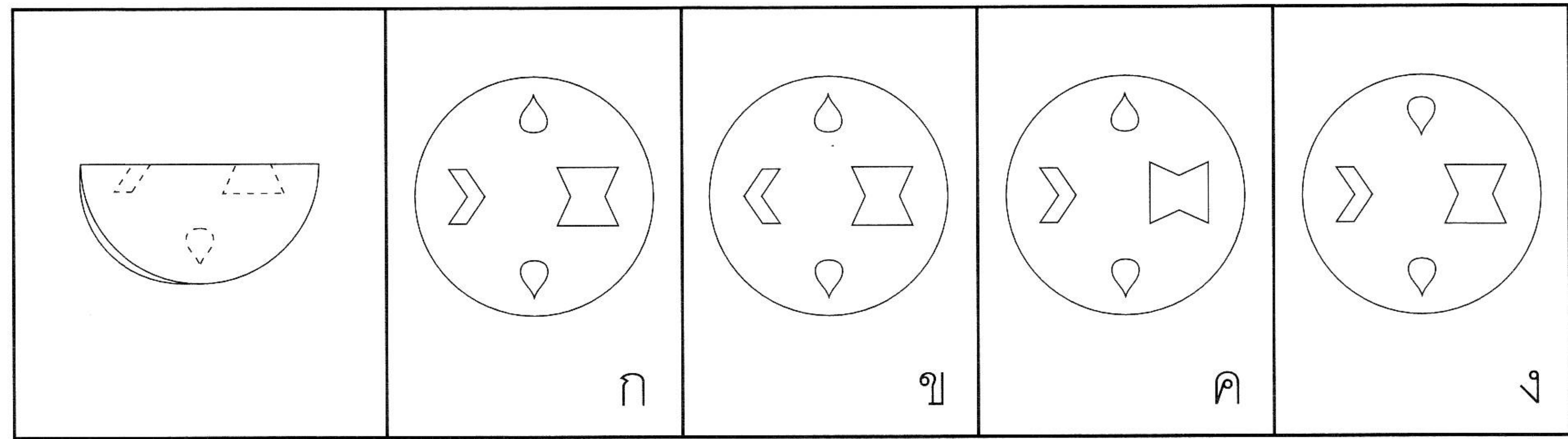

10

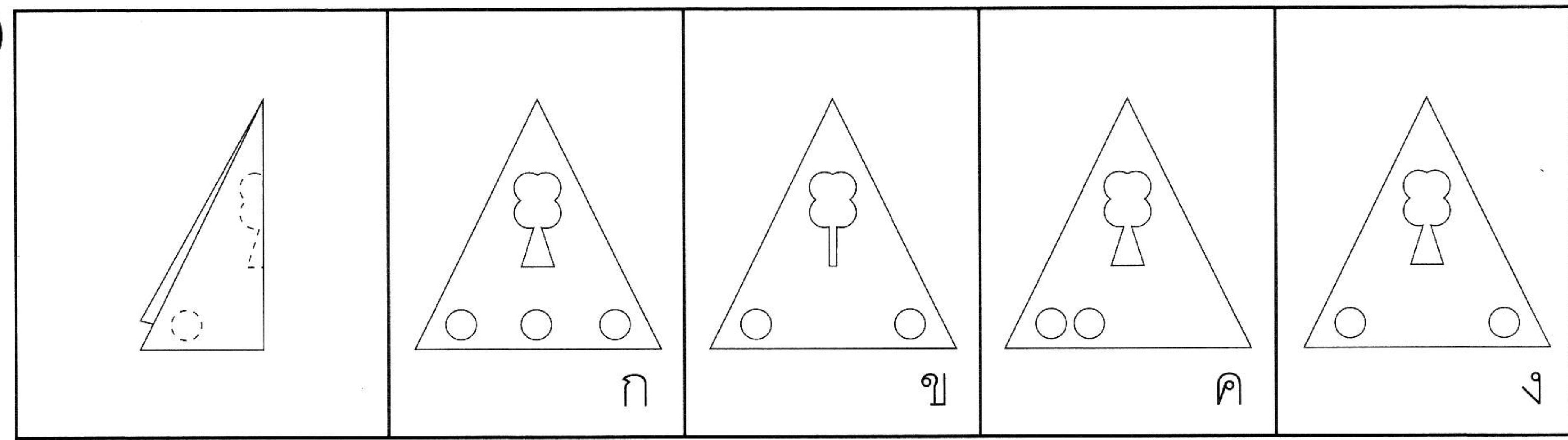

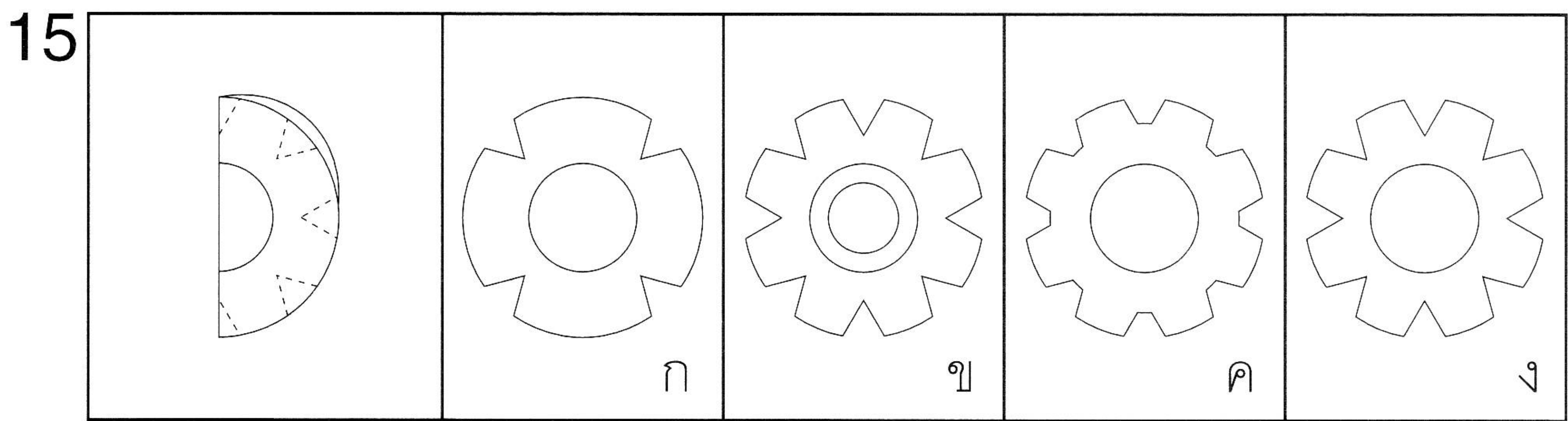
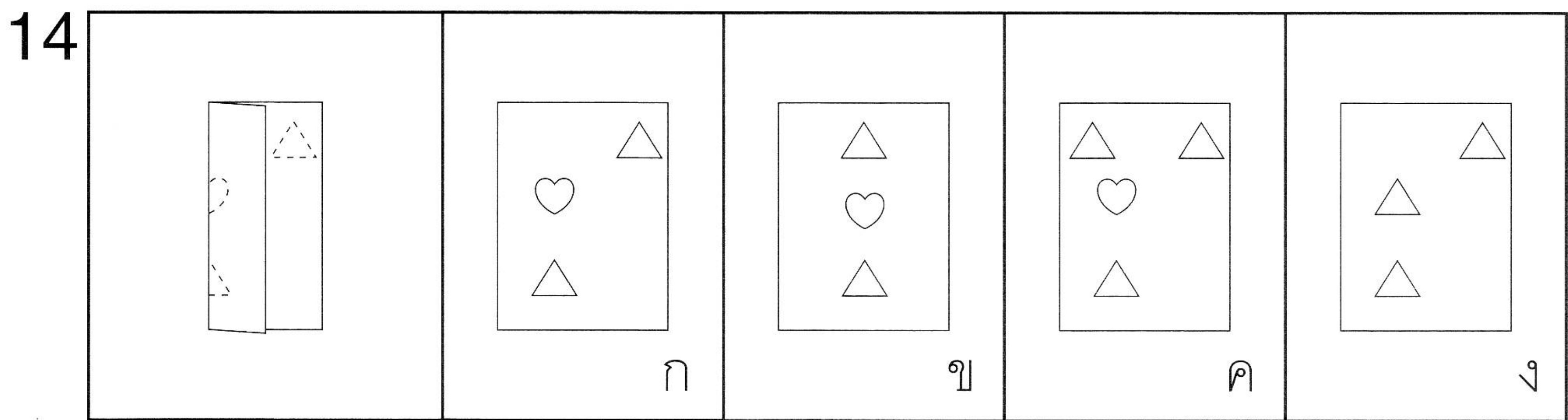
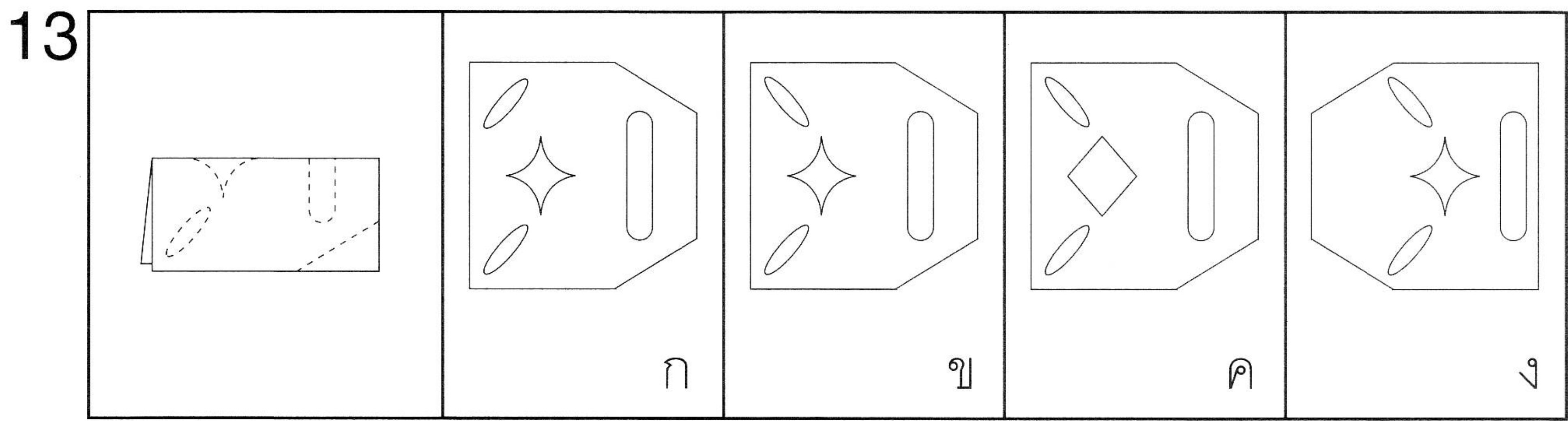
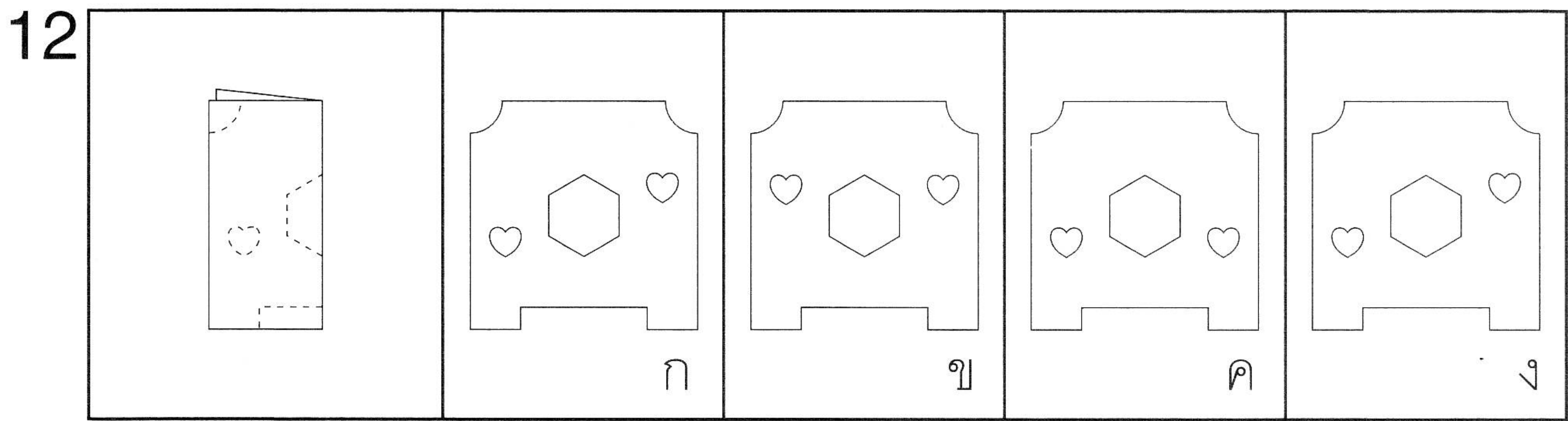
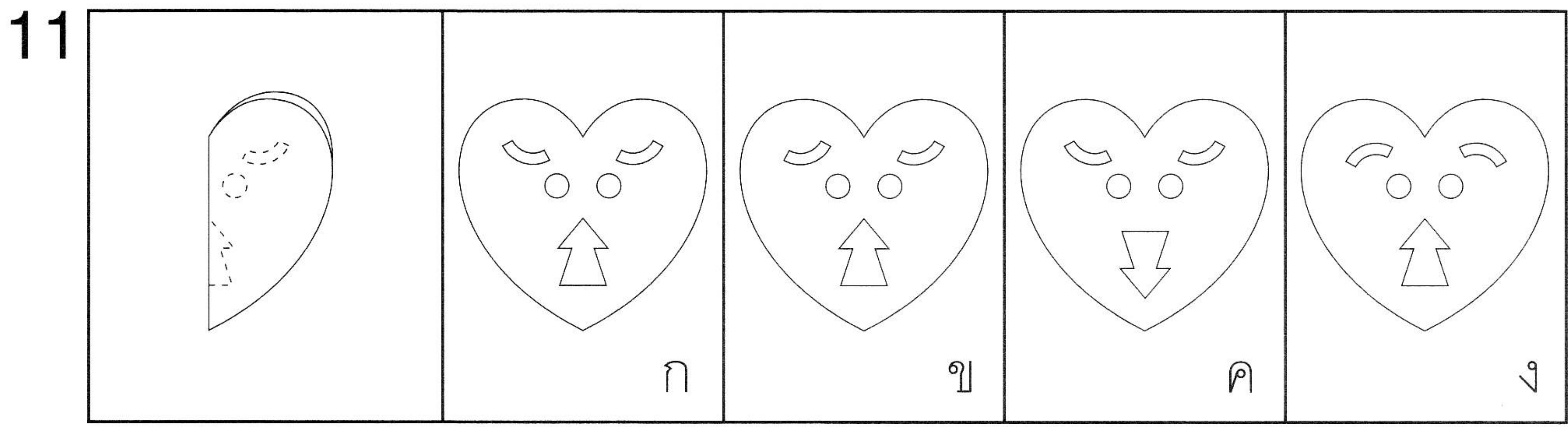

16

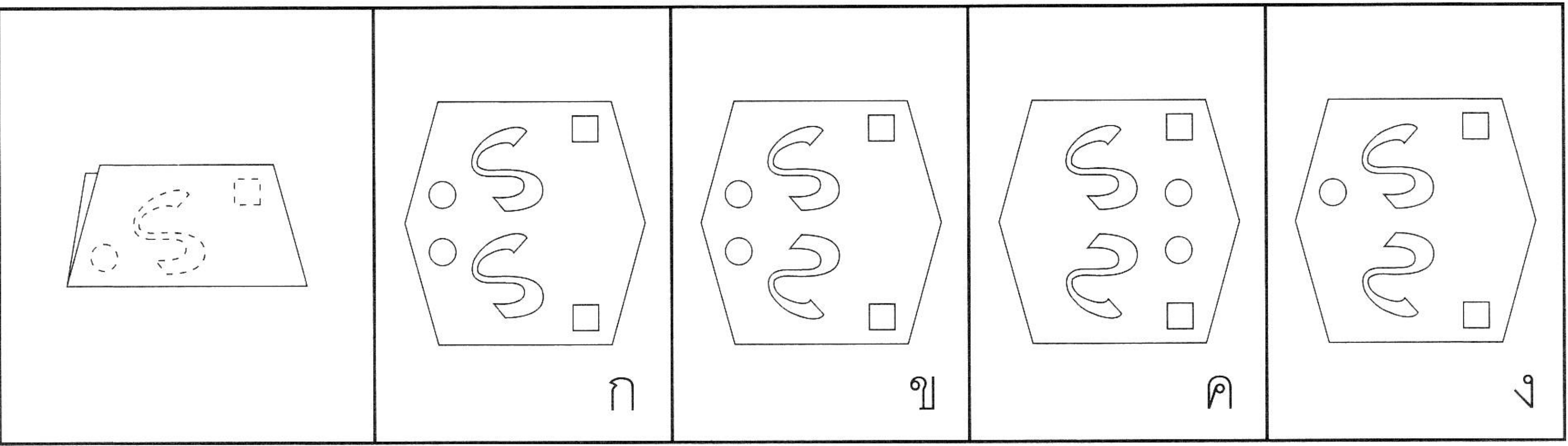

17

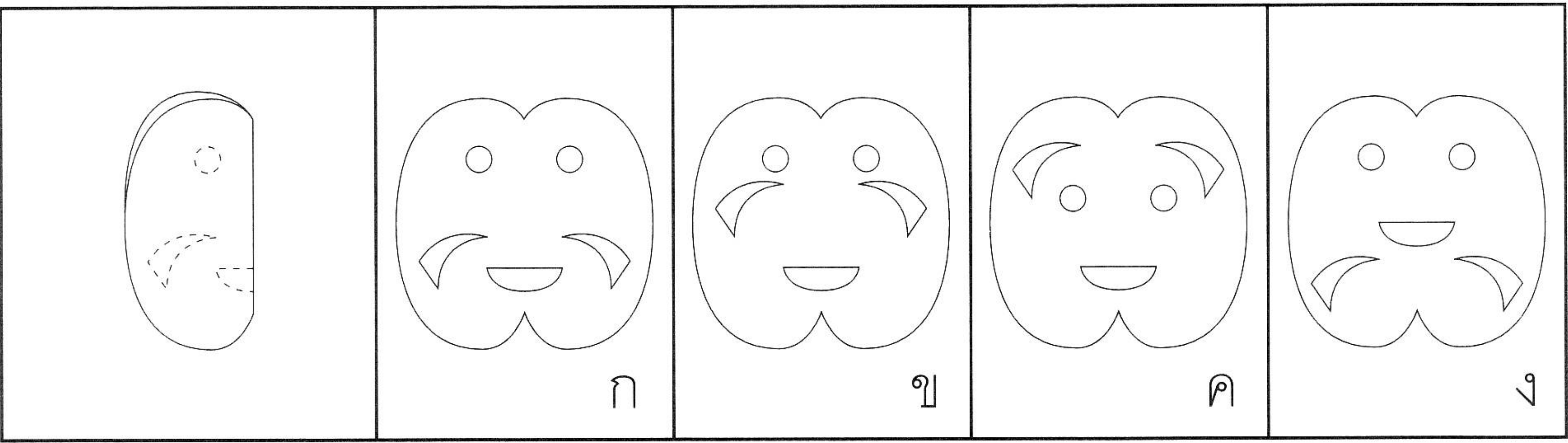

18

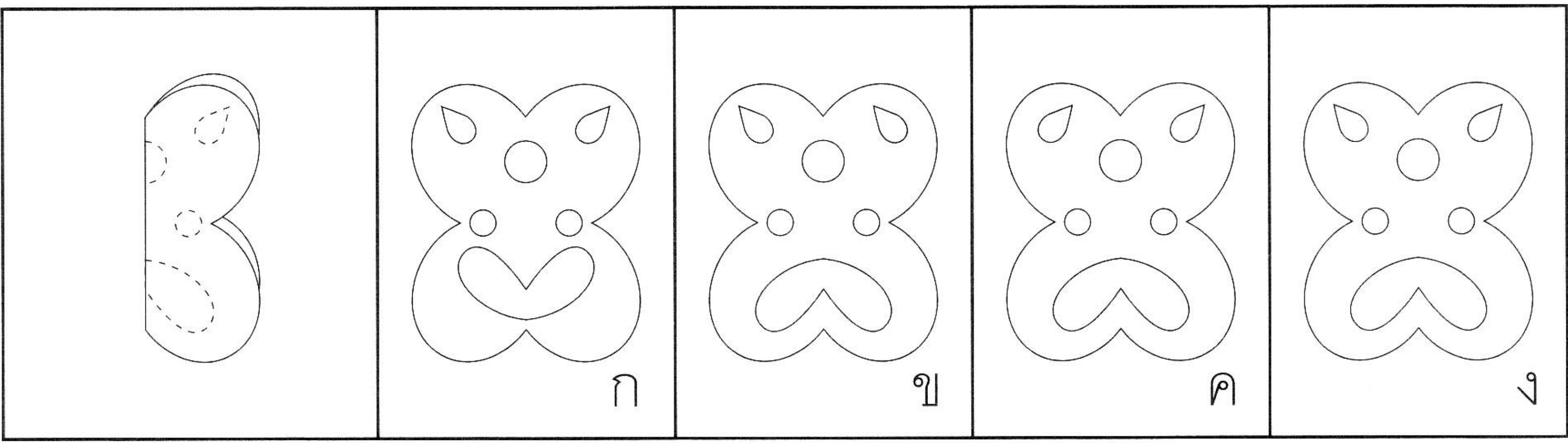

19

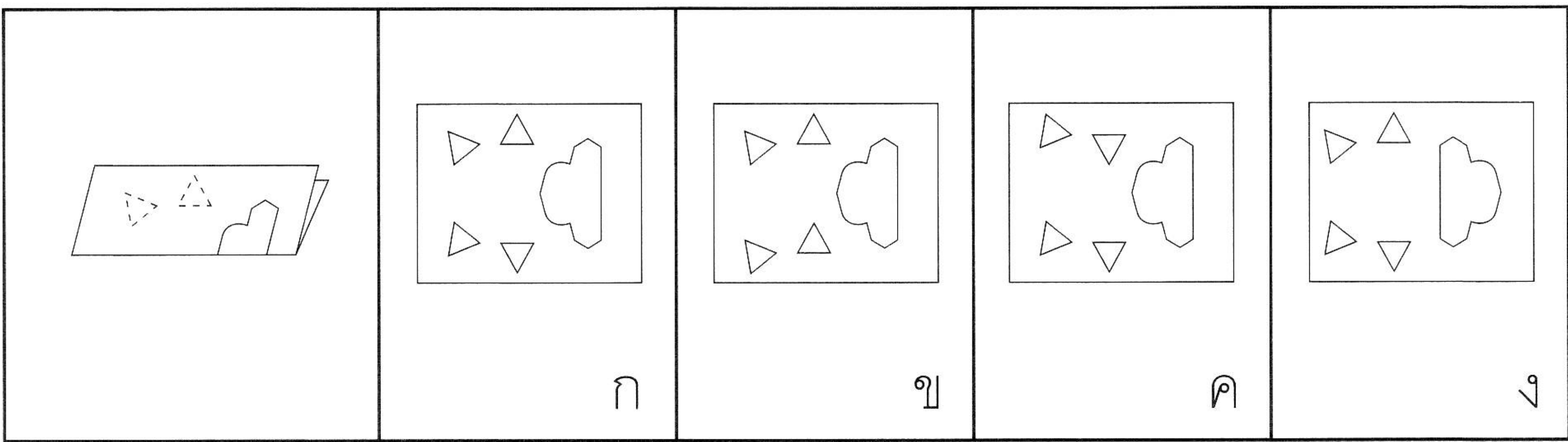

20

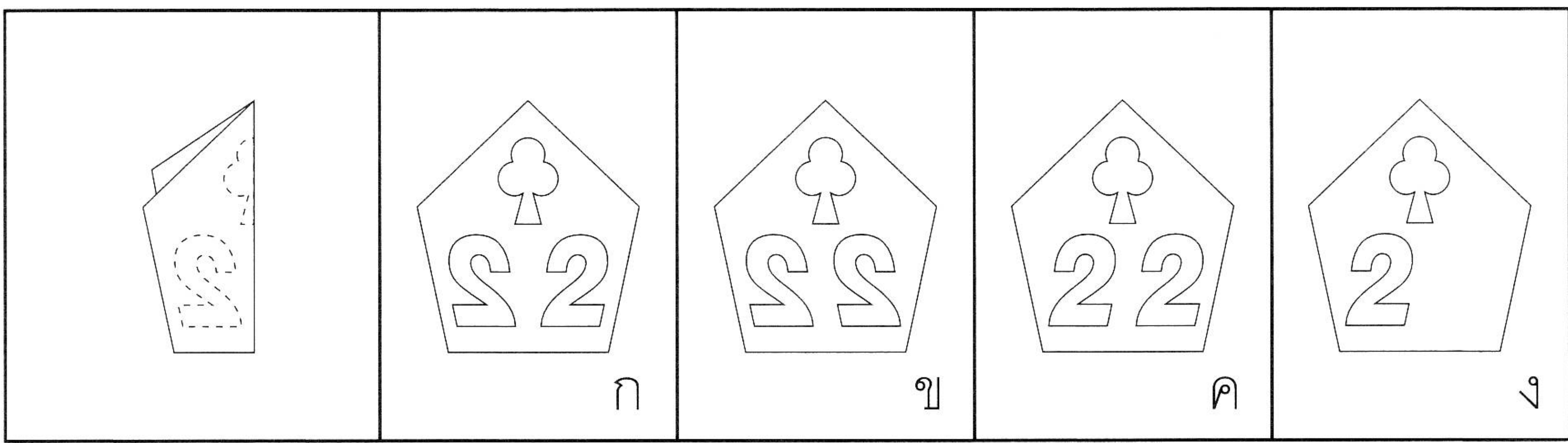

จงขีด ✓ ข้อที่พับแล้วได้กล่องเหมือนภาพในช่องแรก

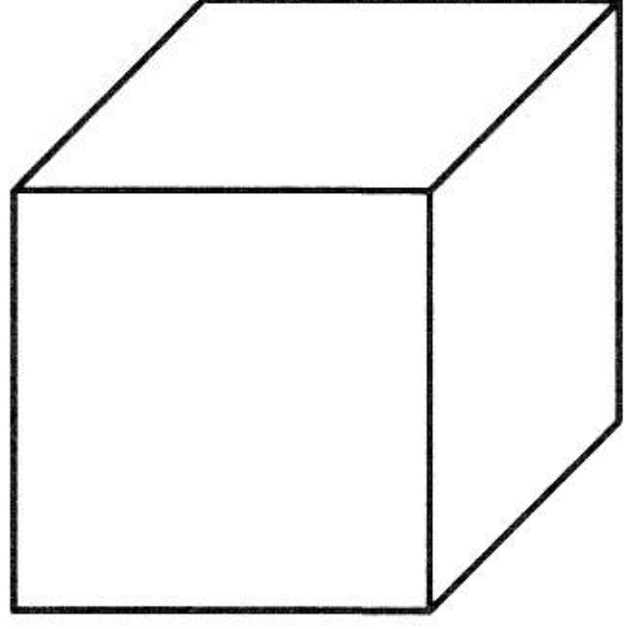
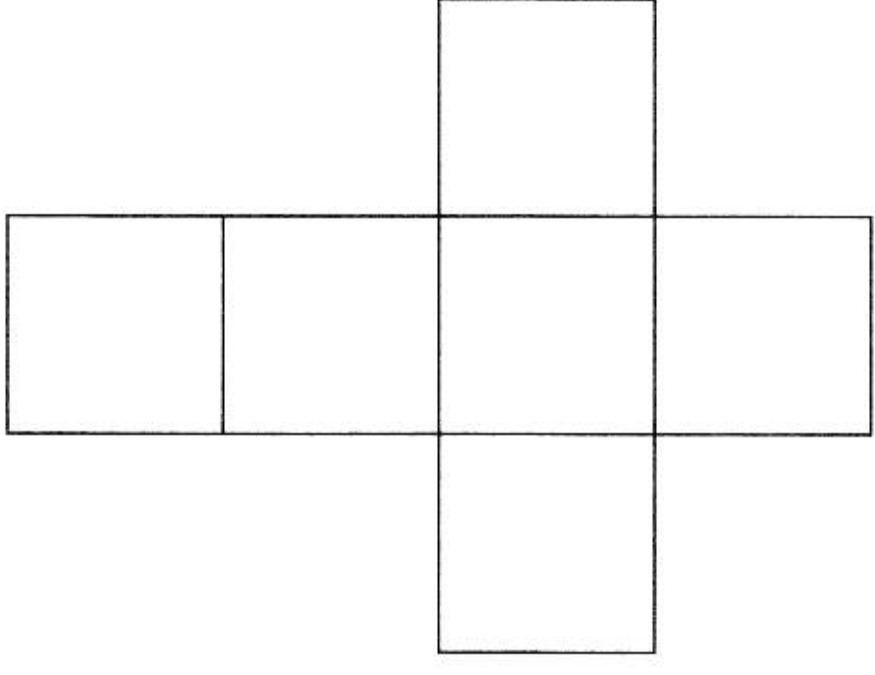
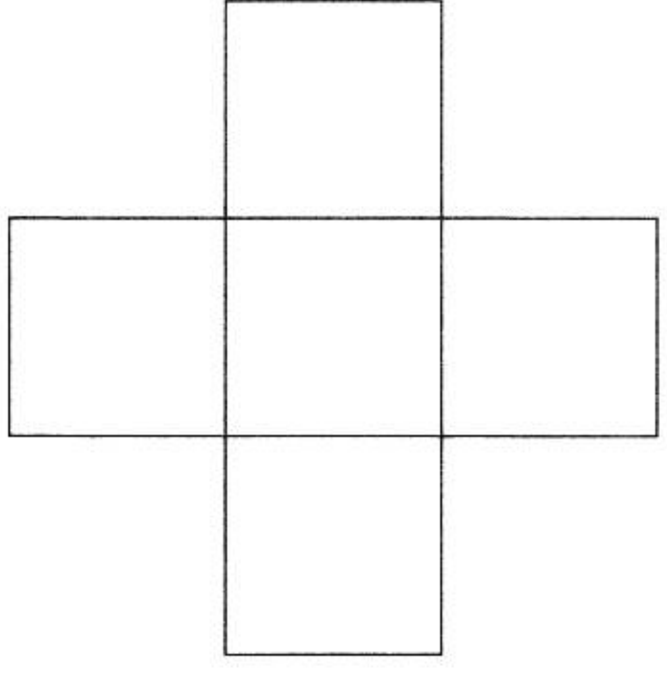
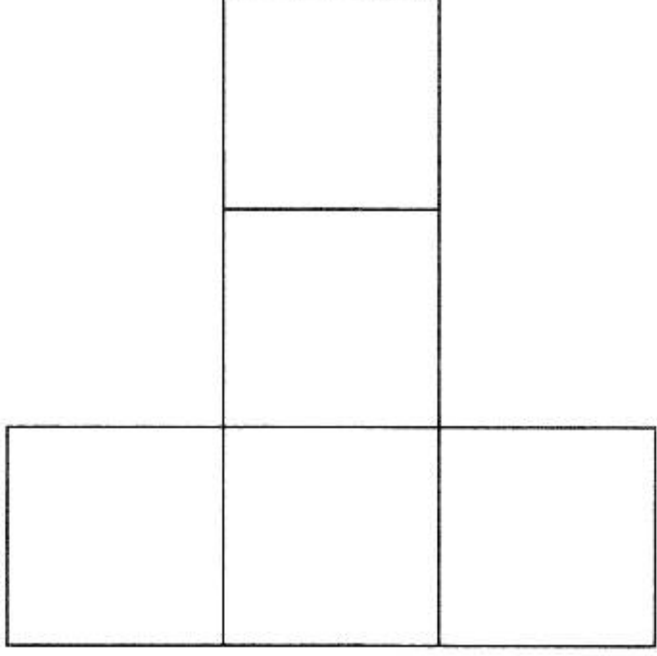
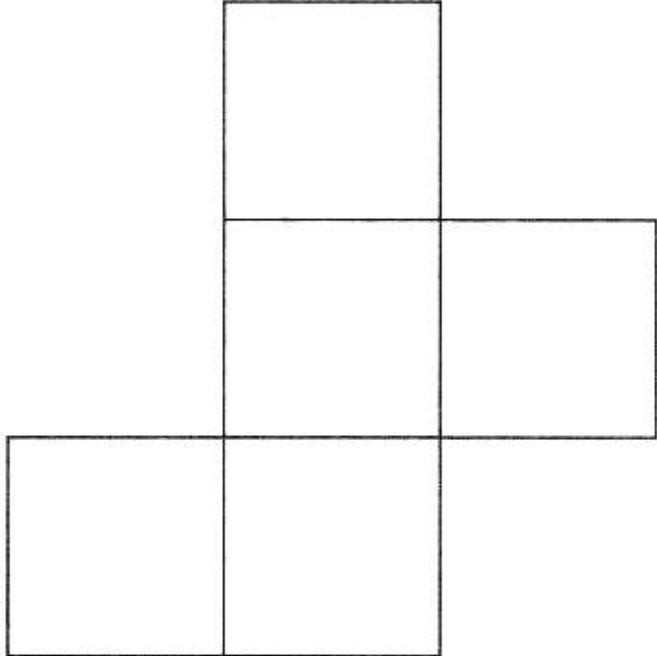
1		 ก	 ข
		 ค	 ง

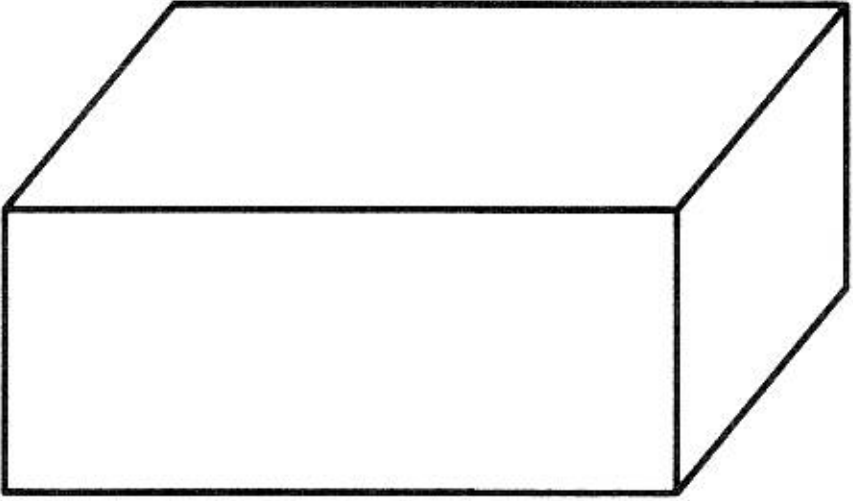
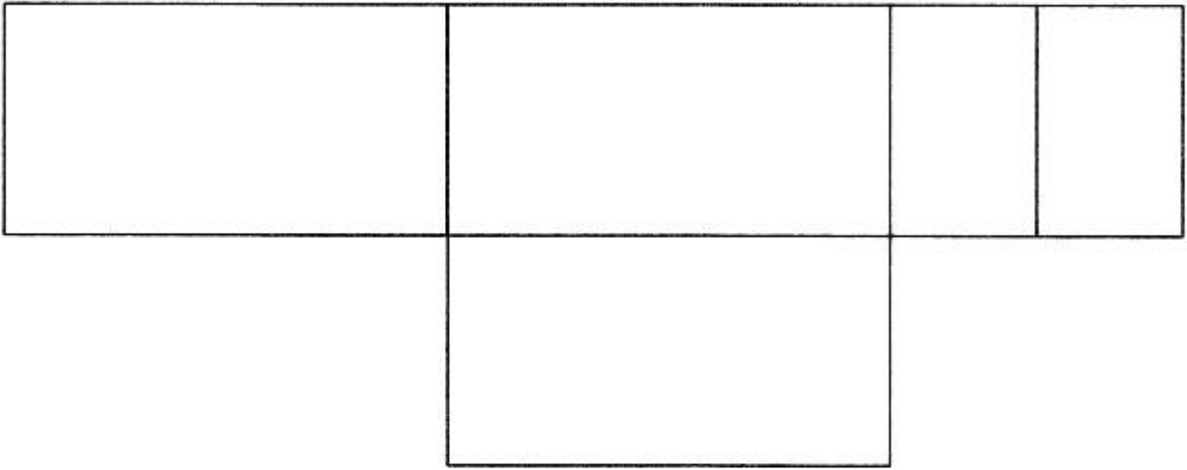
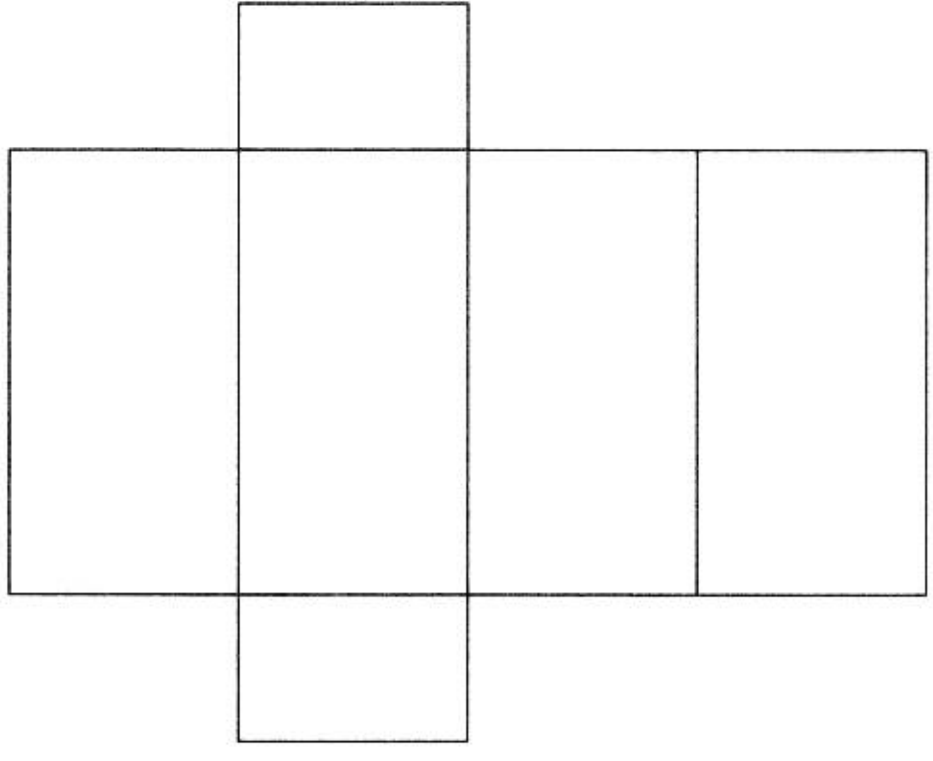
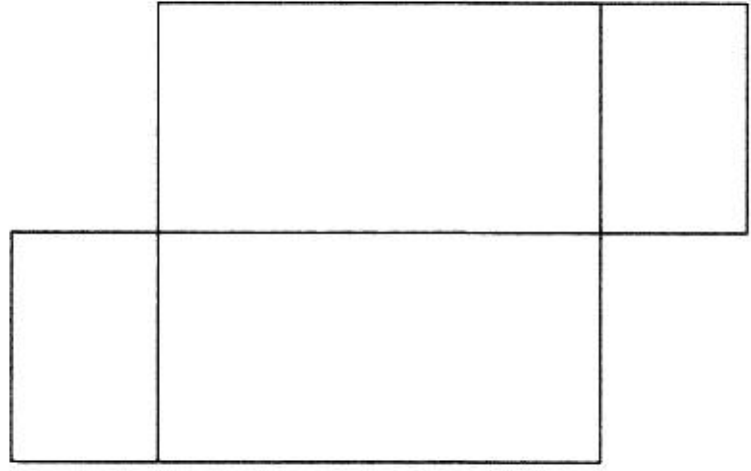
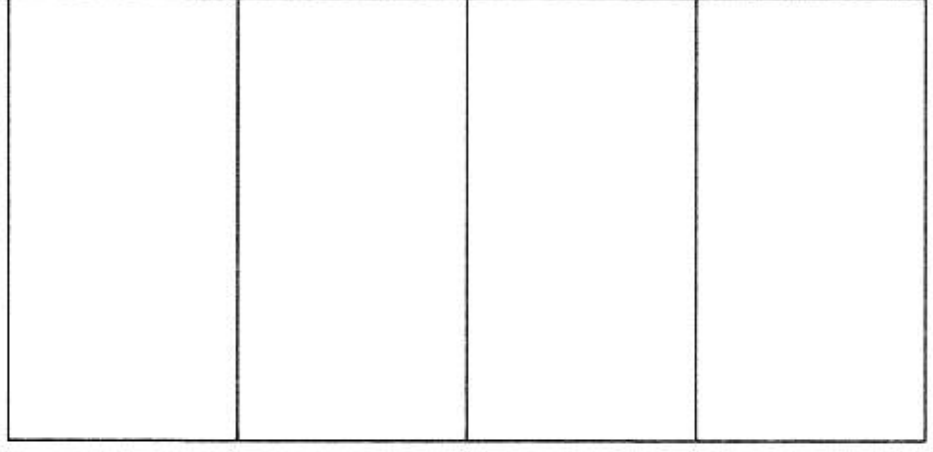
2		 ก	 ข
		 ค	 ง

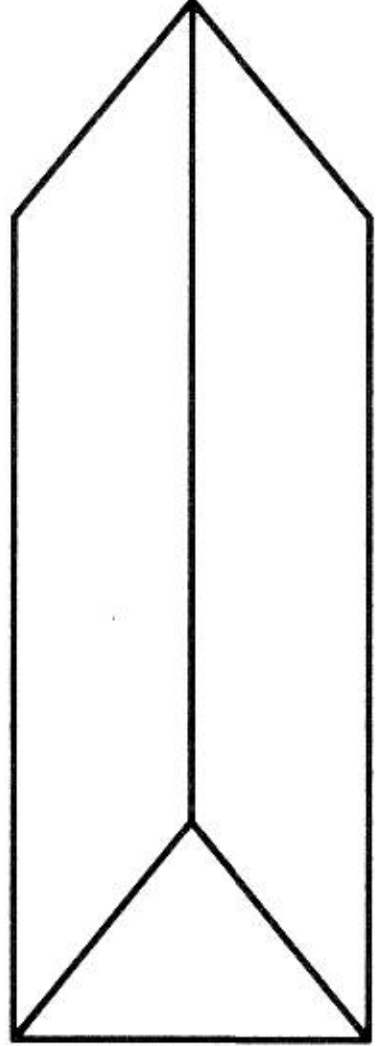
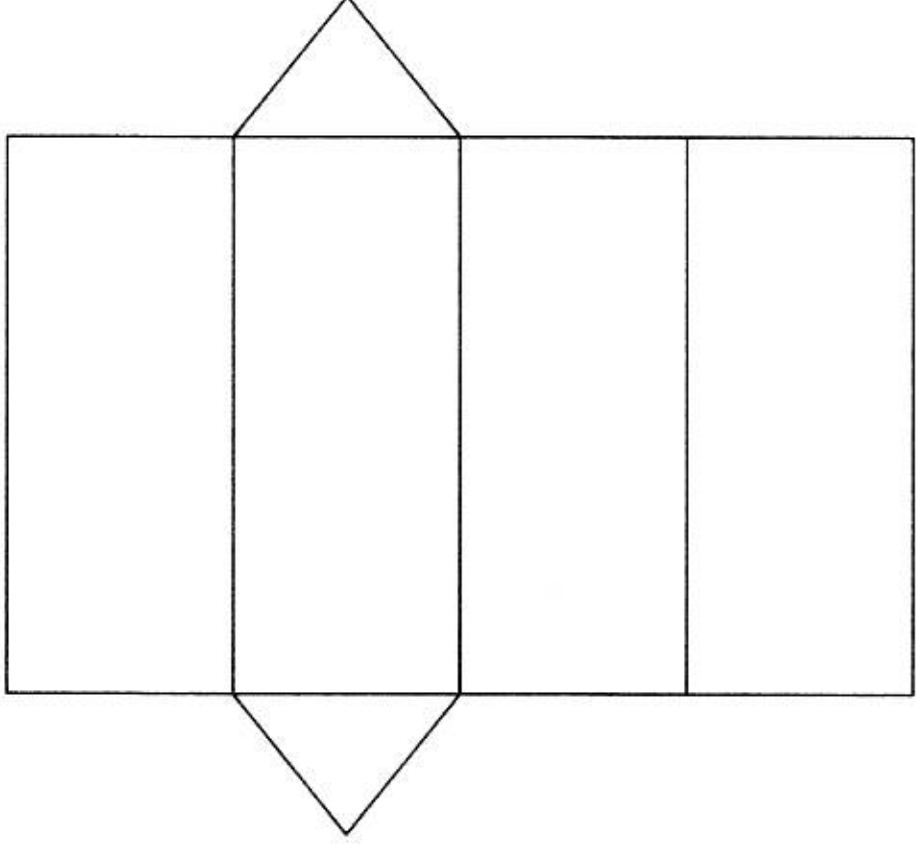
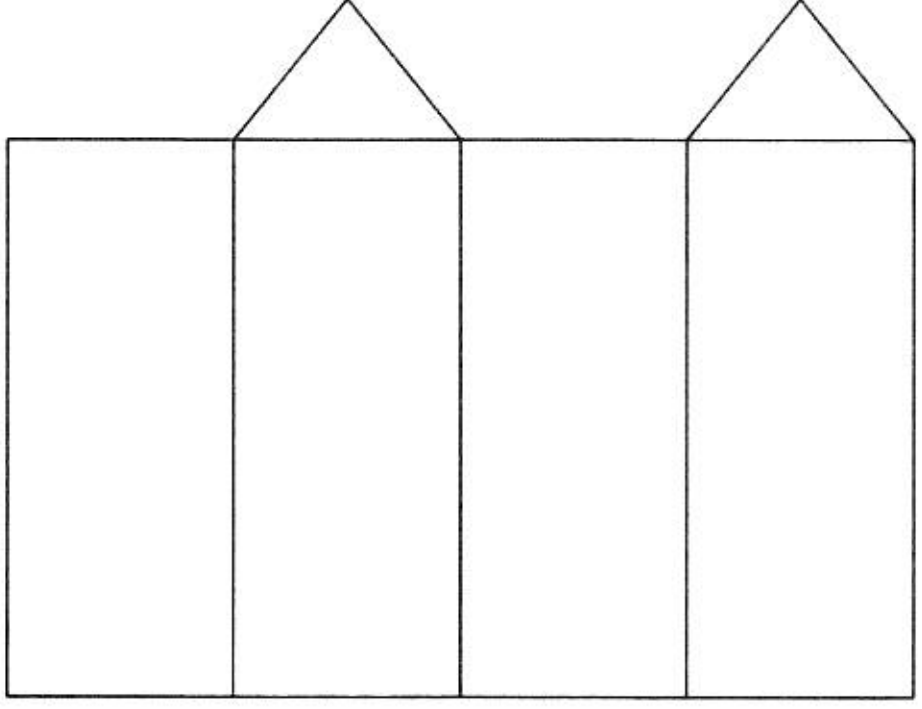
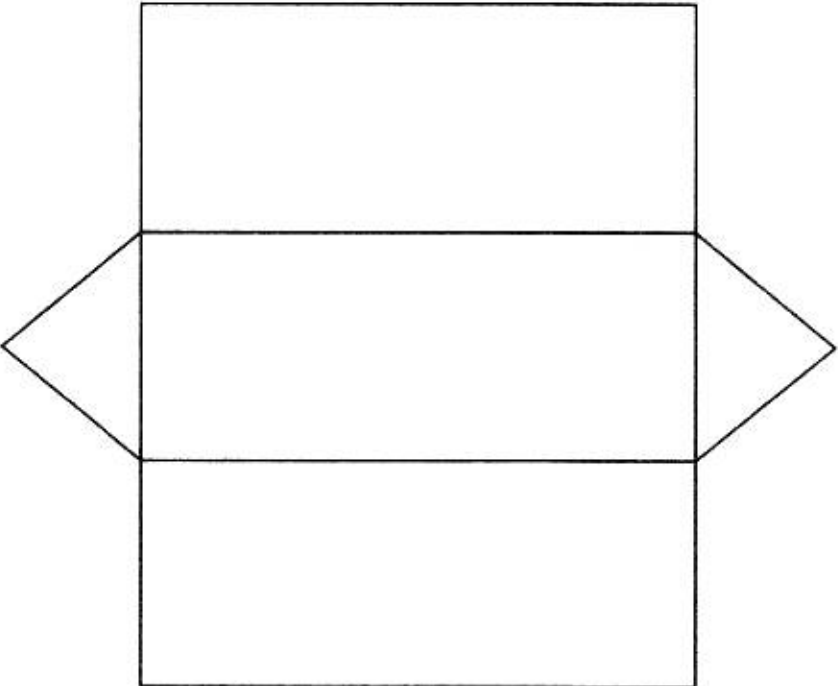
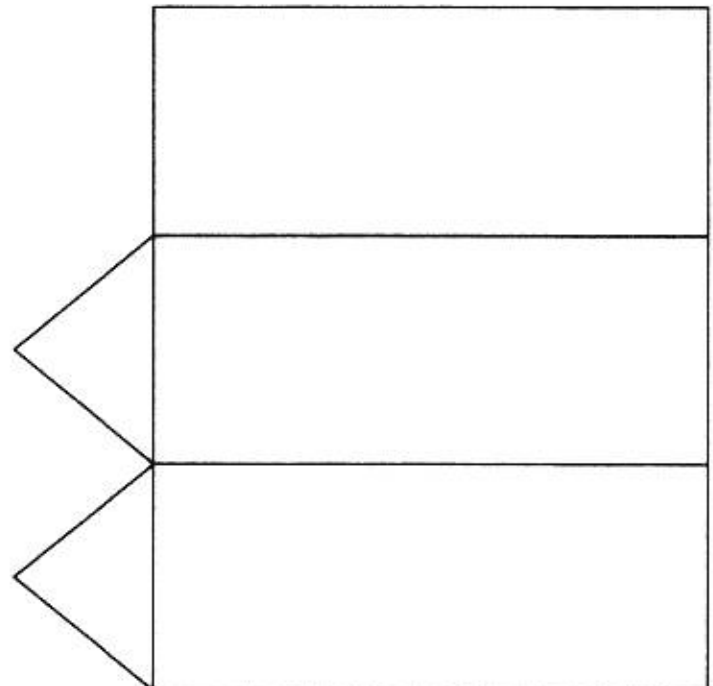
3		 ก	 ข
		 ค	 ง

4

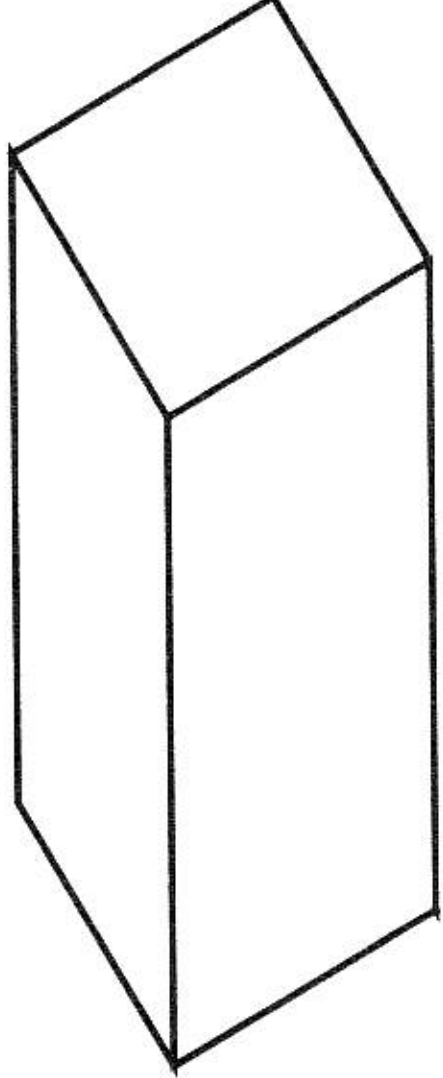

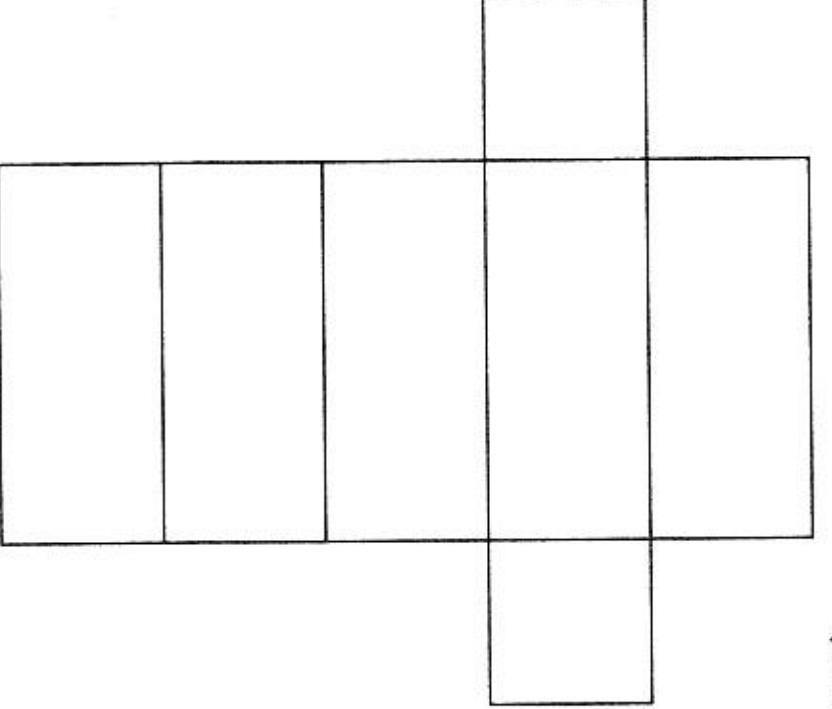
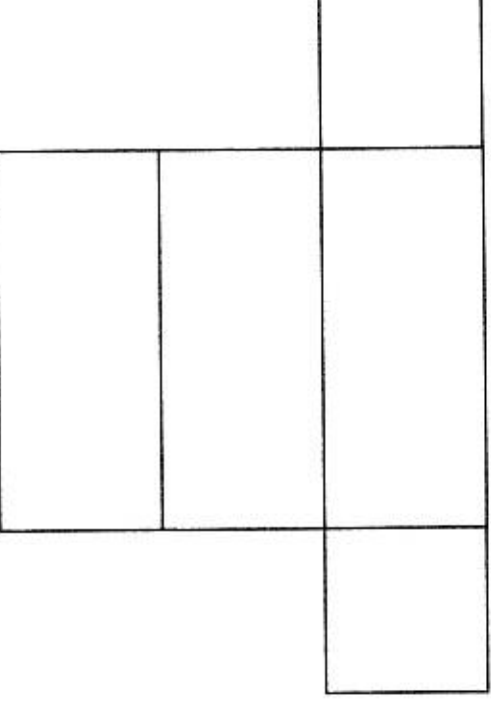
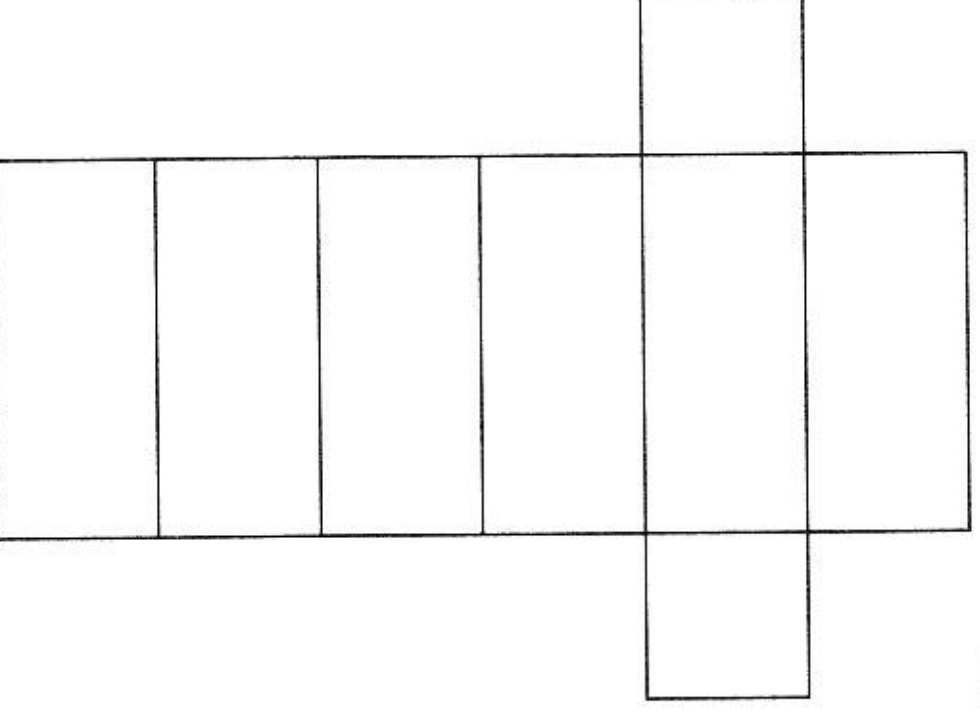
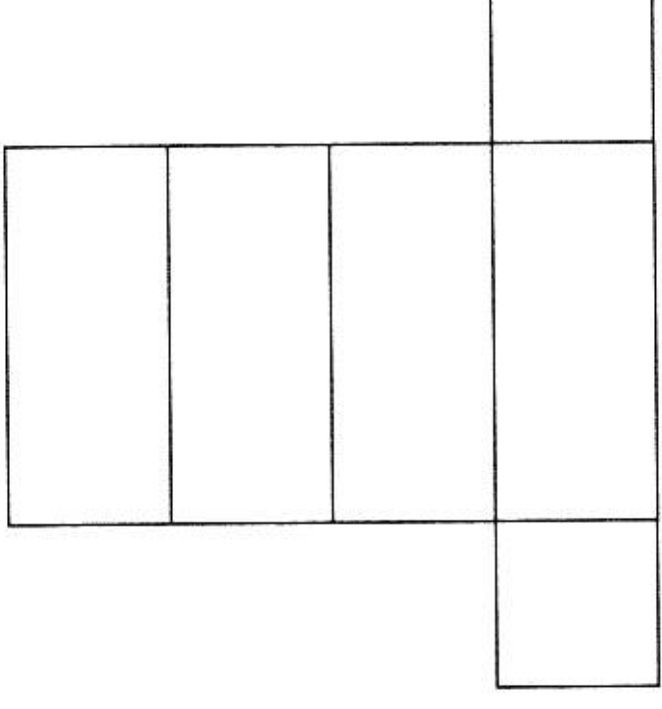
 <p>ก</p>	 <p>ข</p>
 <p>ค</p>	 <p>ง</p>

5

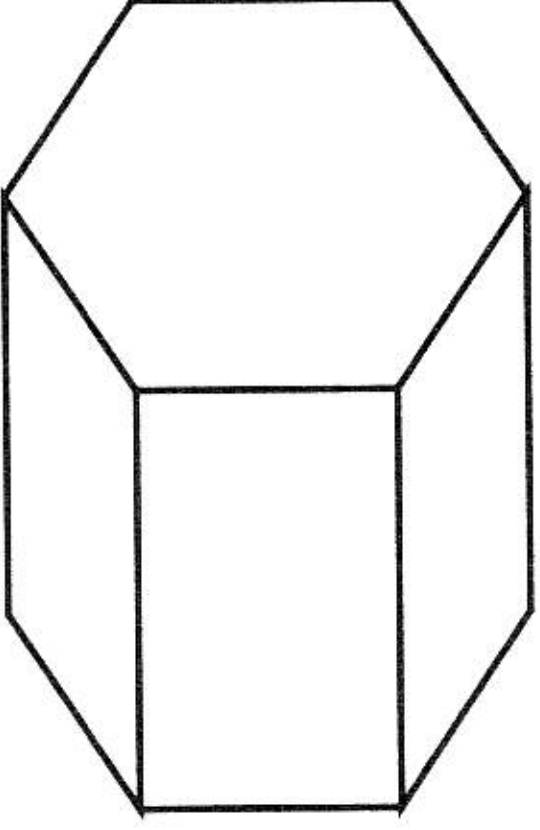

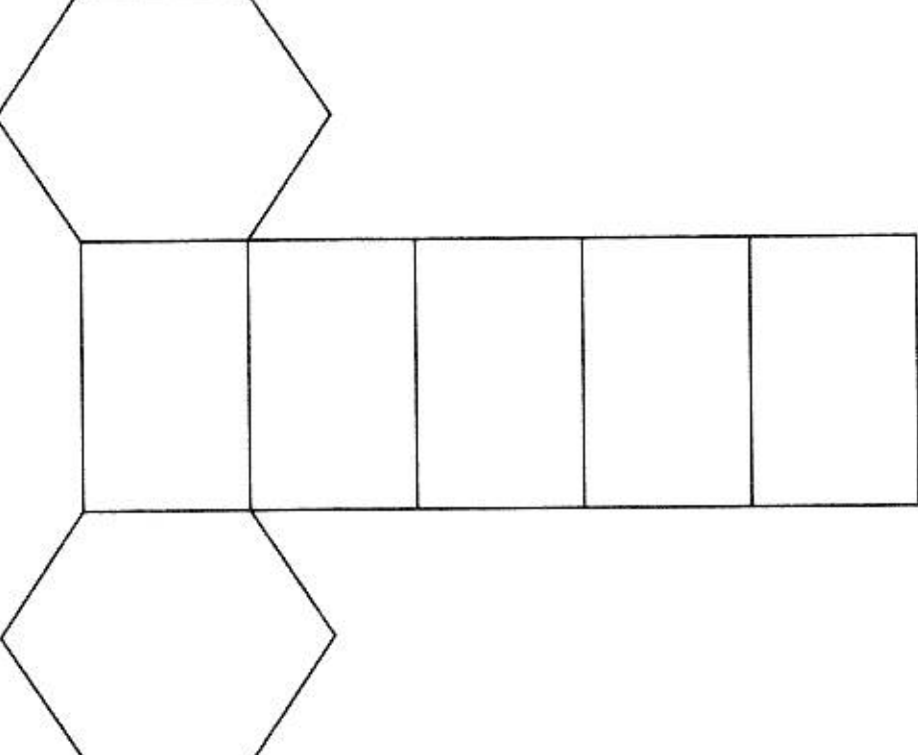
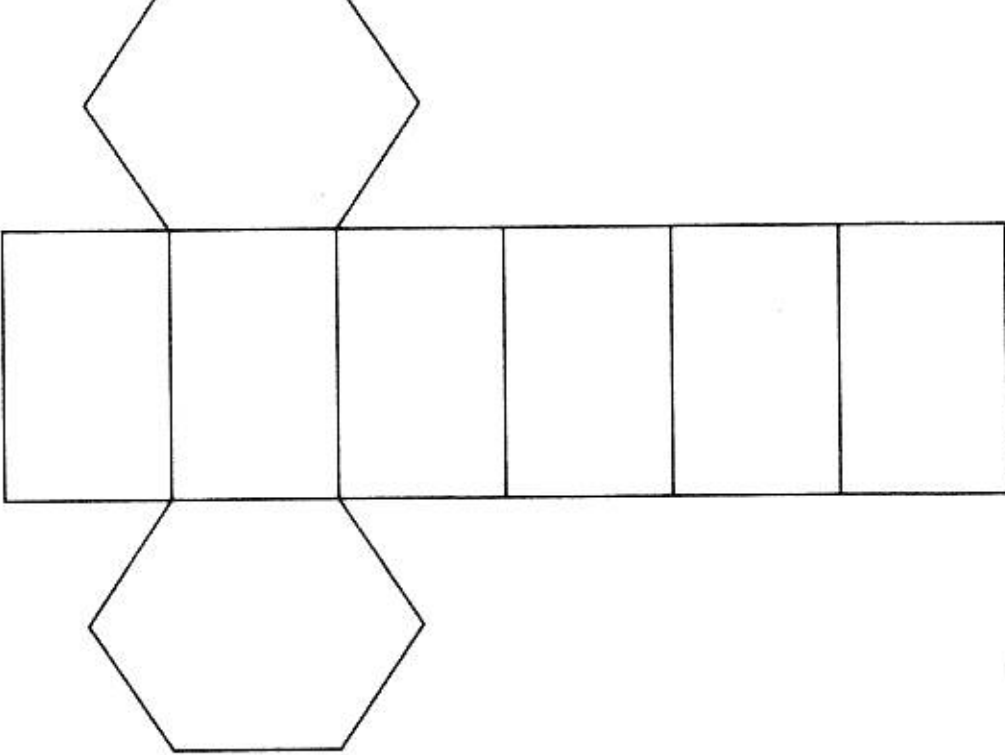
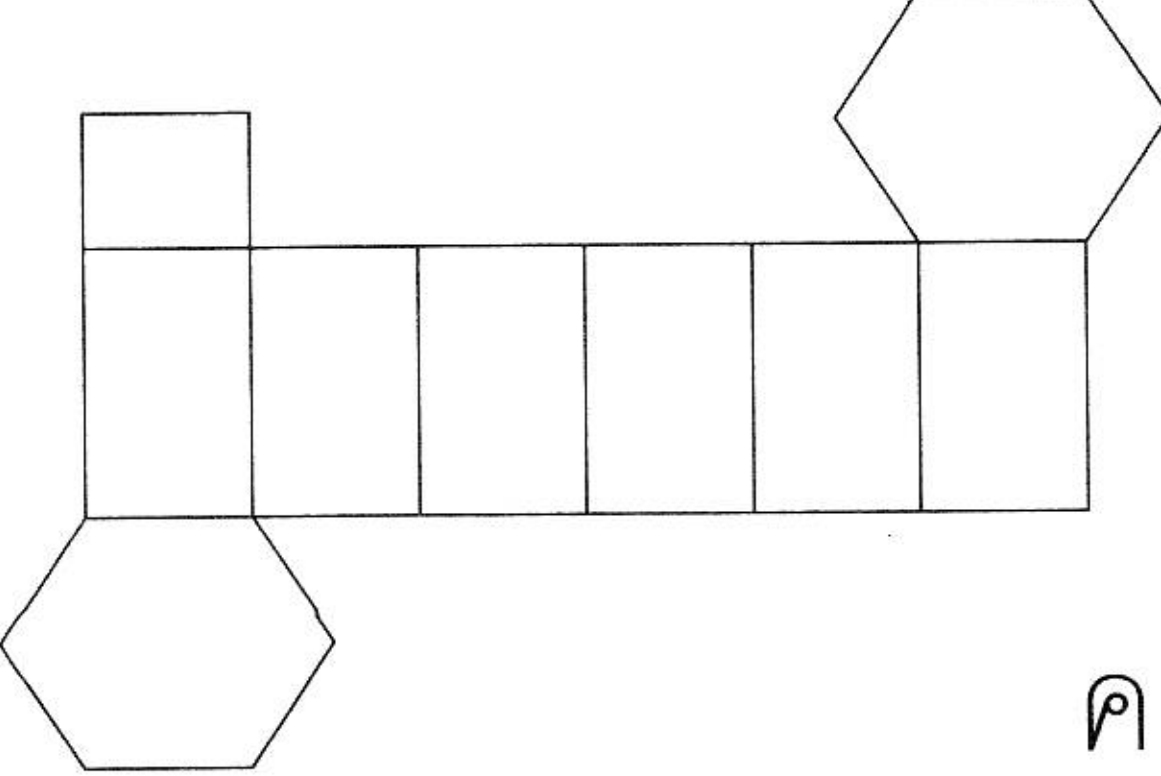
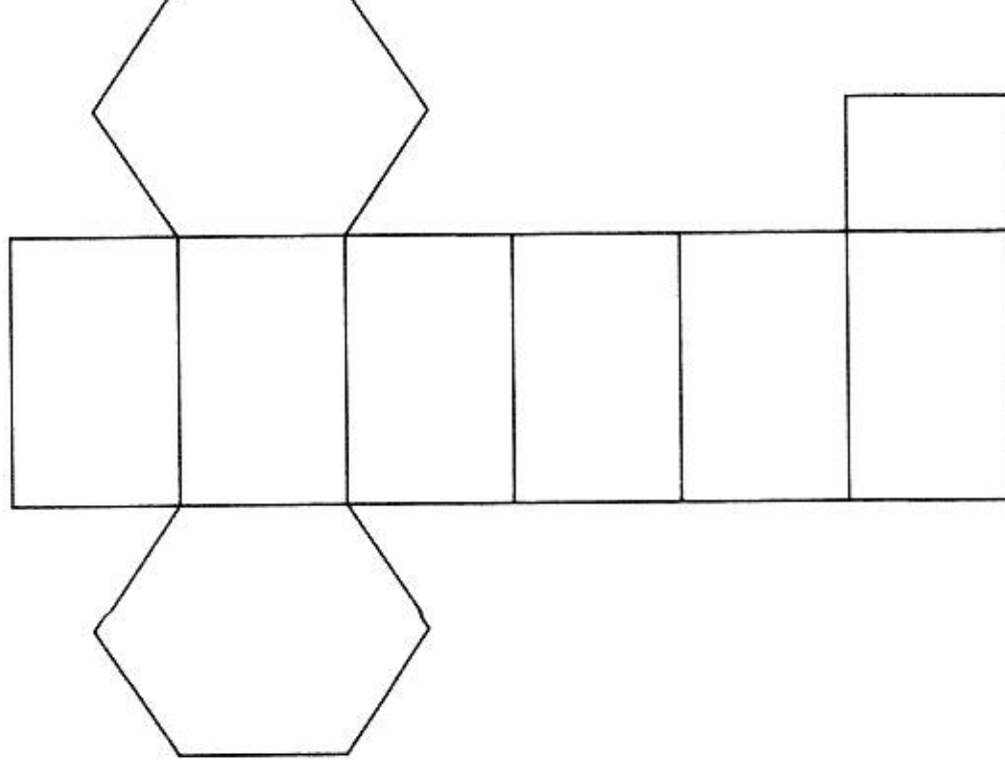
 <p>ก</p>	 <p>ข</p>
 <p>ค</p>	 <p>ง</p>

6

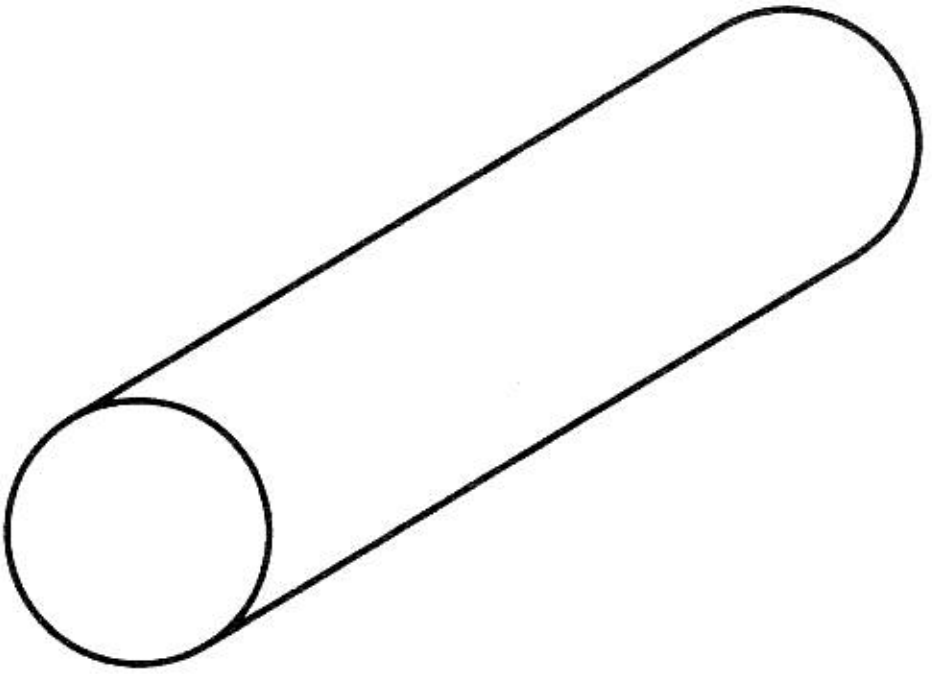

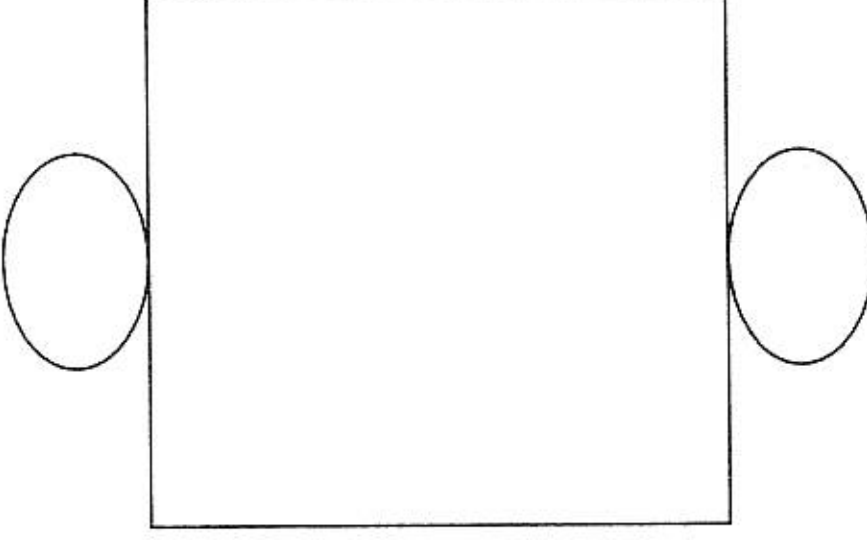
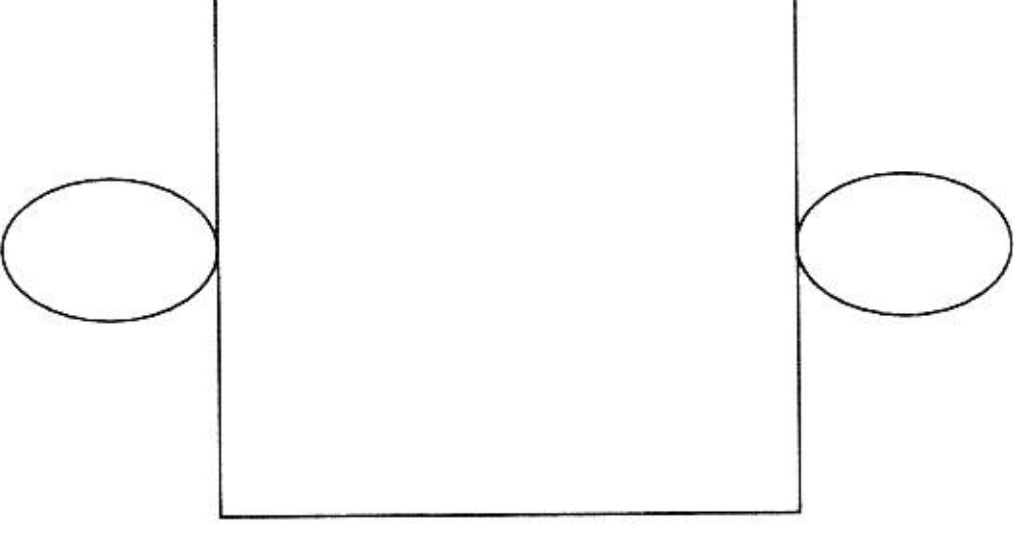
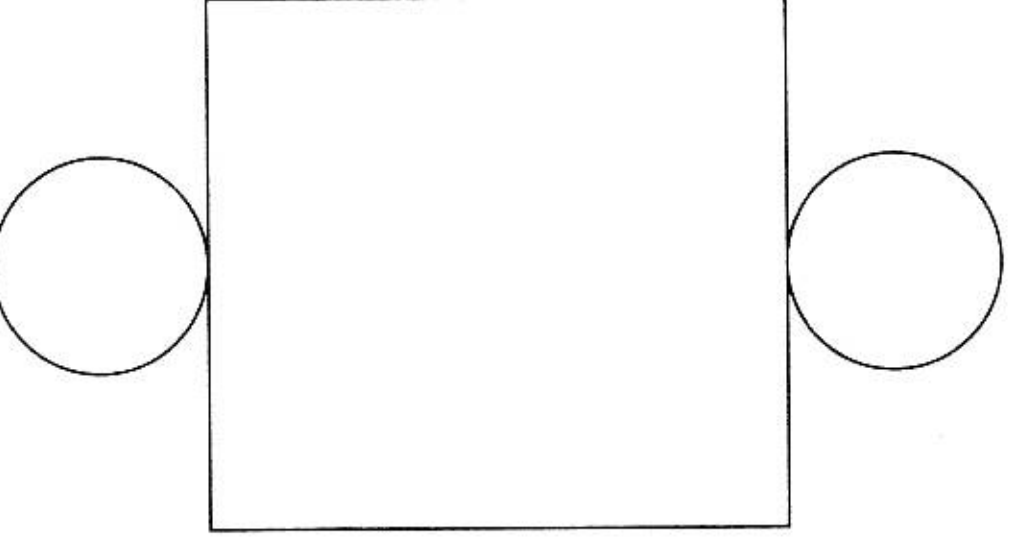
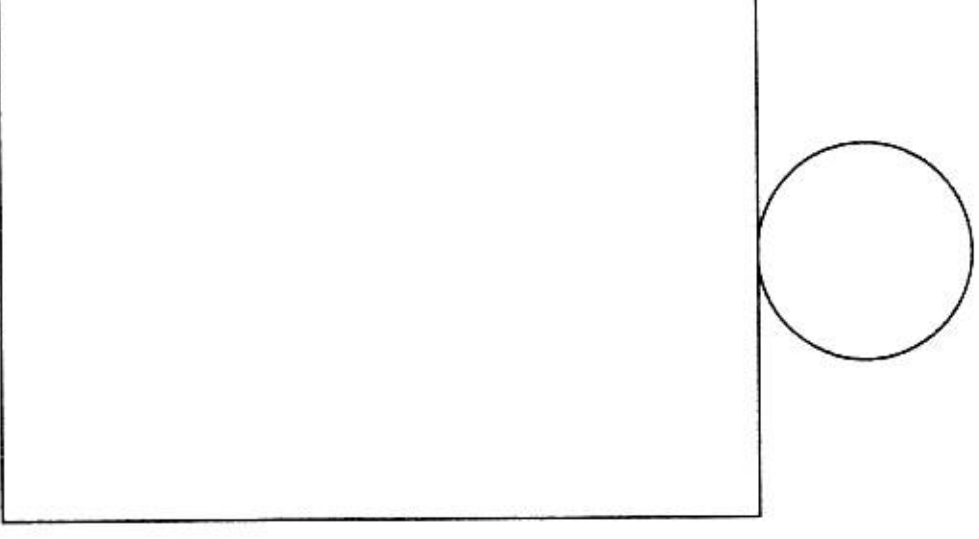
 <p>ก</p>	 <p>ข</p>
 <p>ค</p>	 <p>ง</p>

7

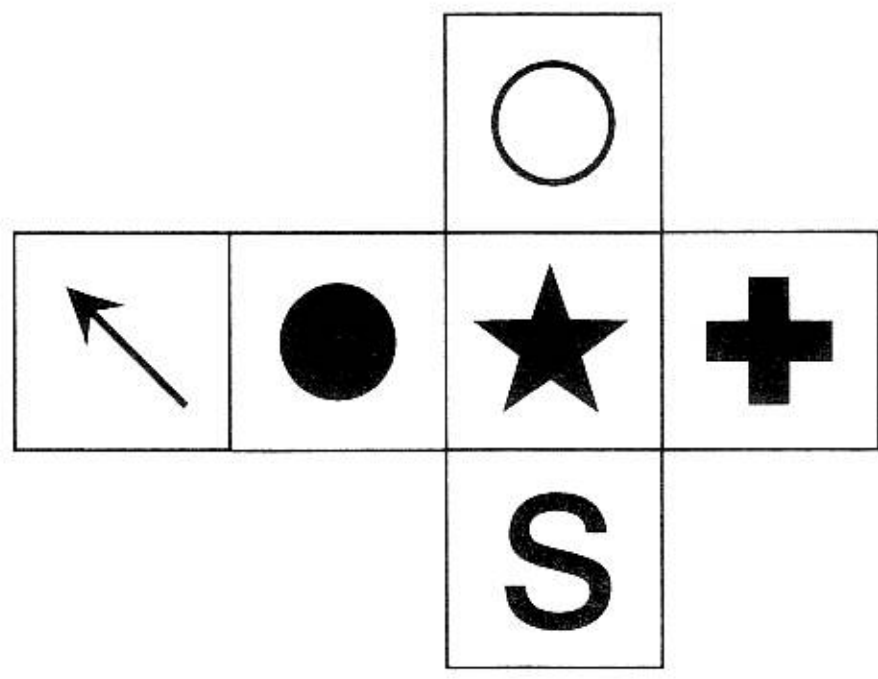
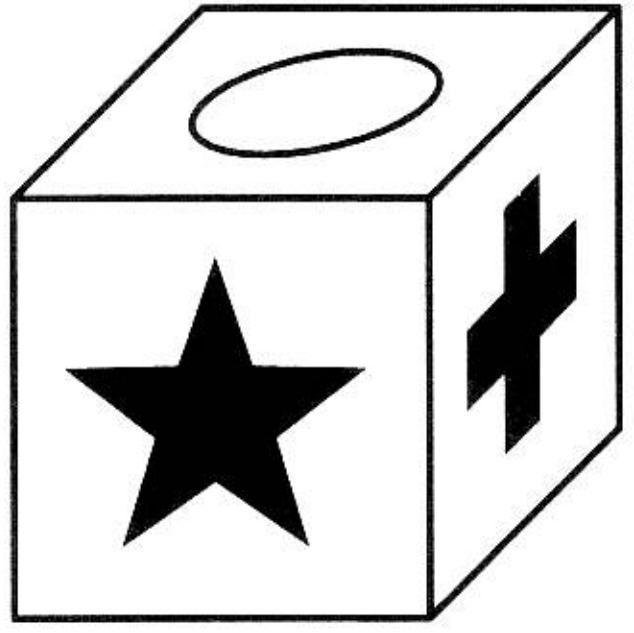

ก

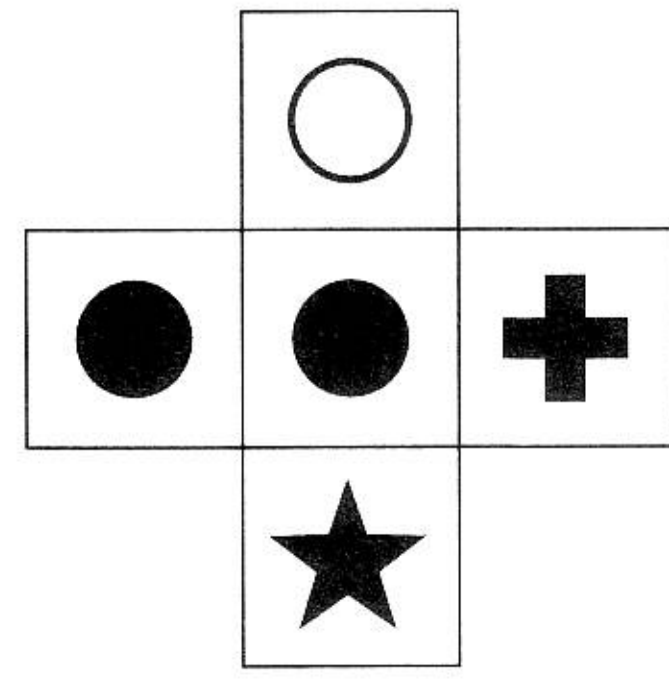

ข

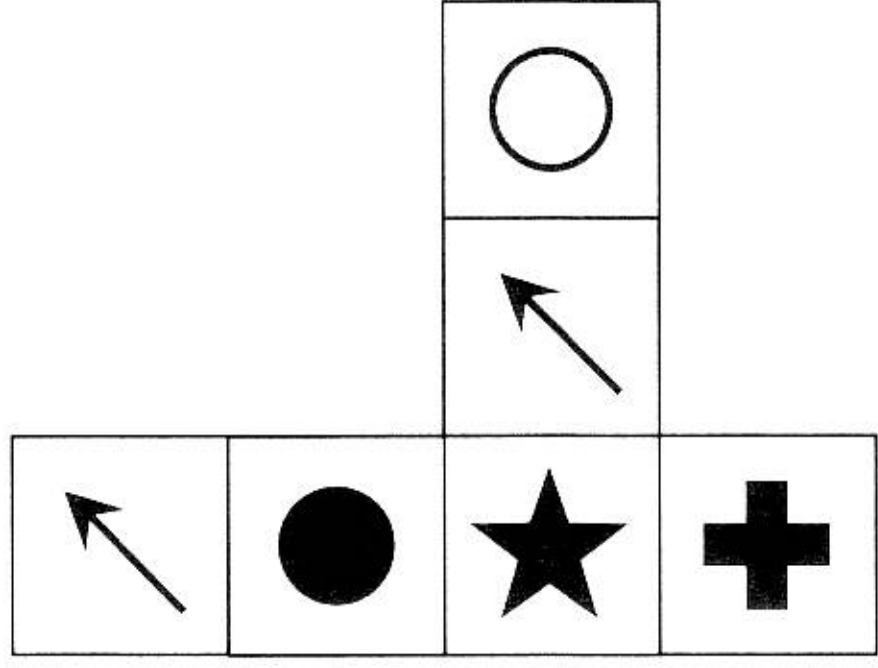

ค

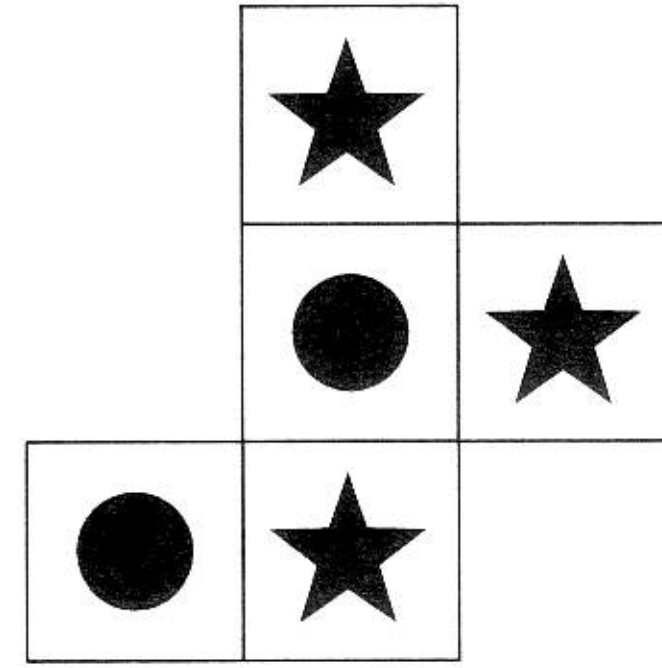

ง

8

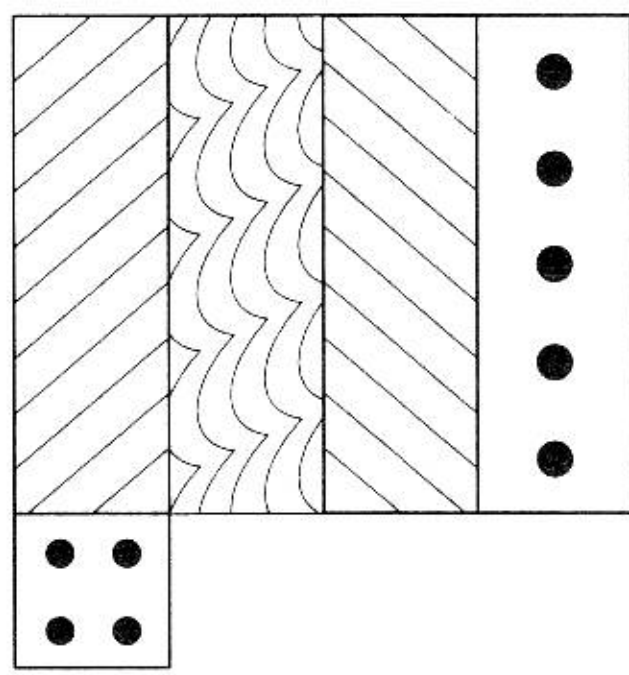
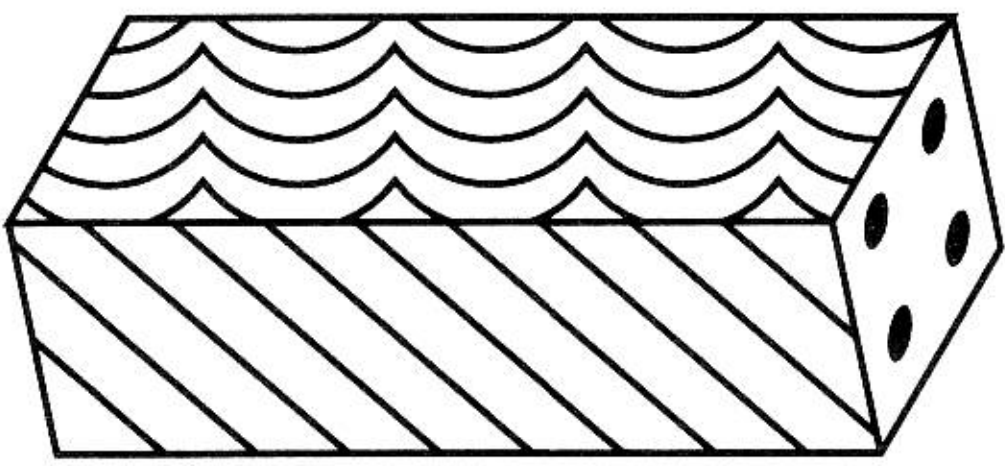

ก

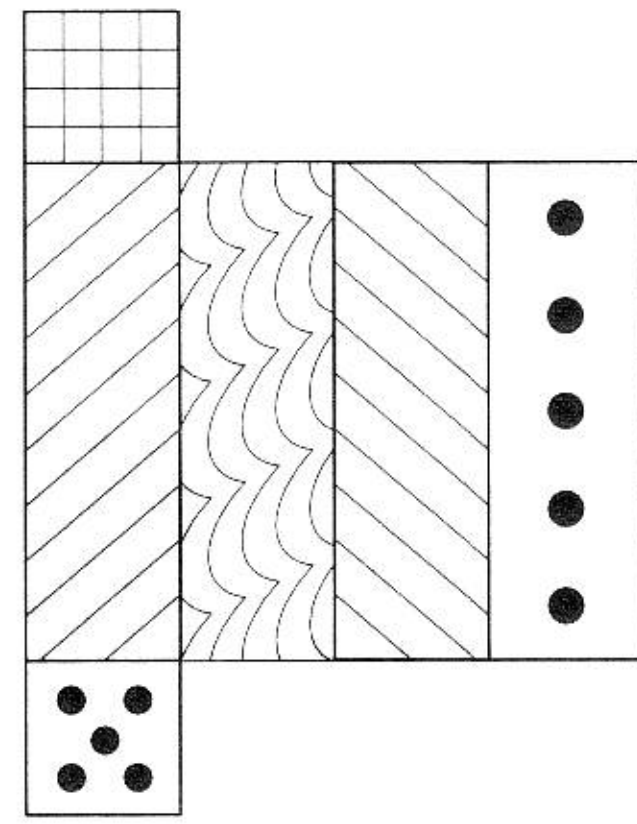

ข

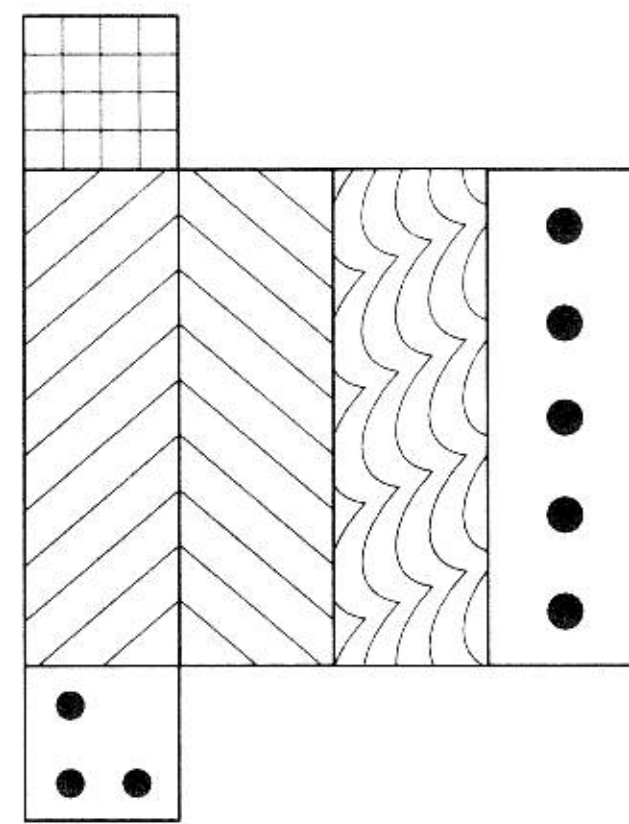

ค

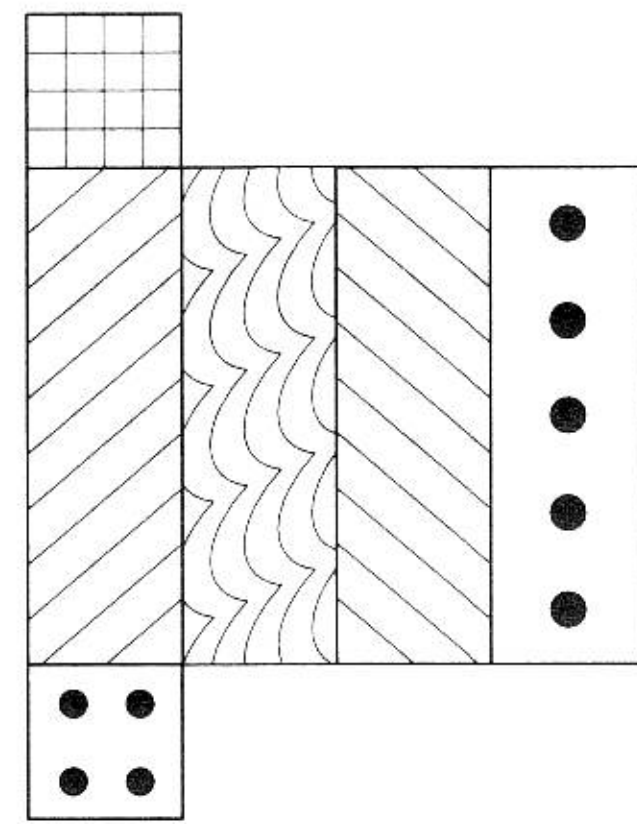

ง

9

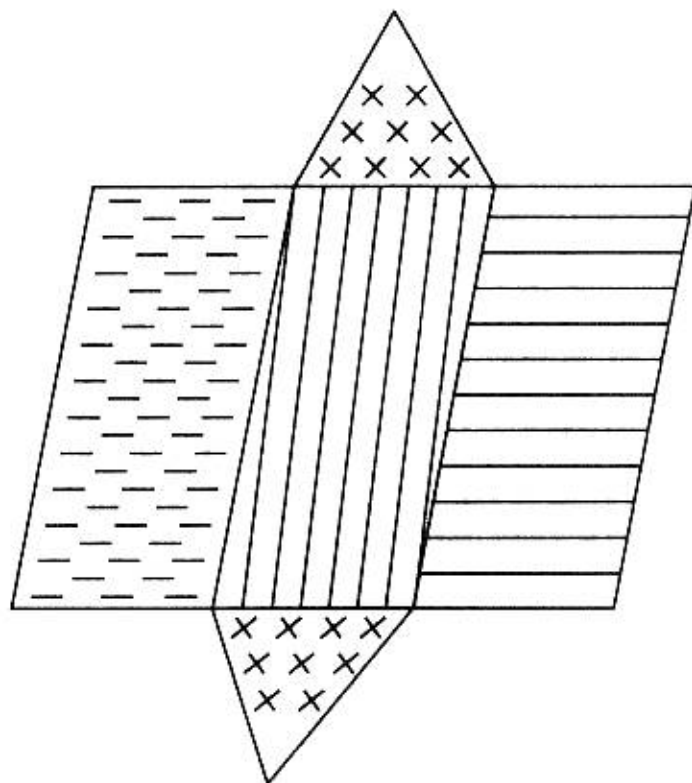
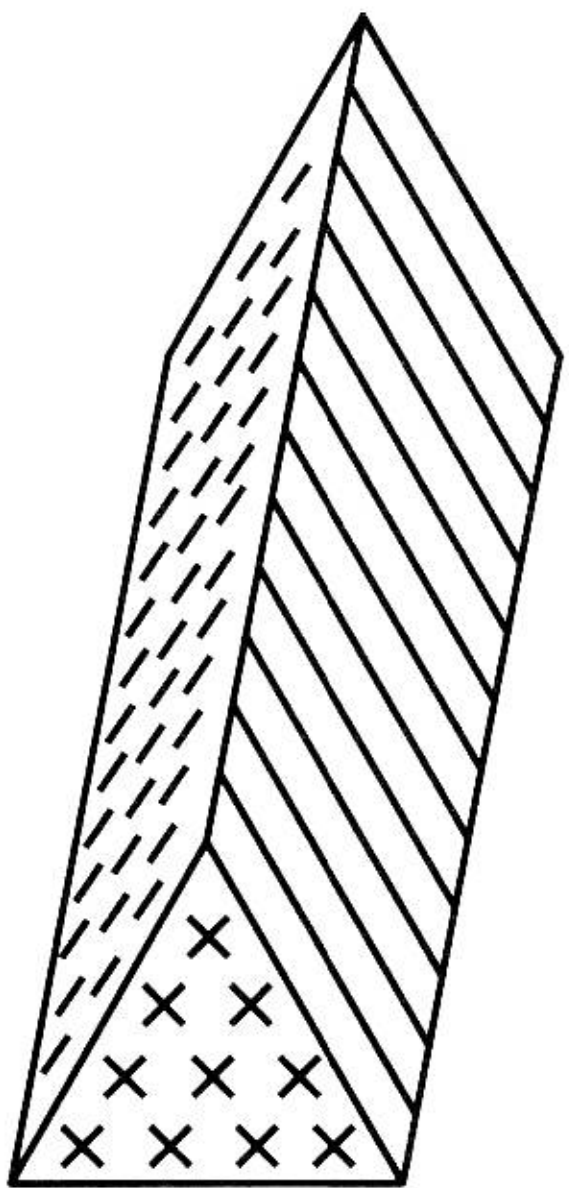

ก

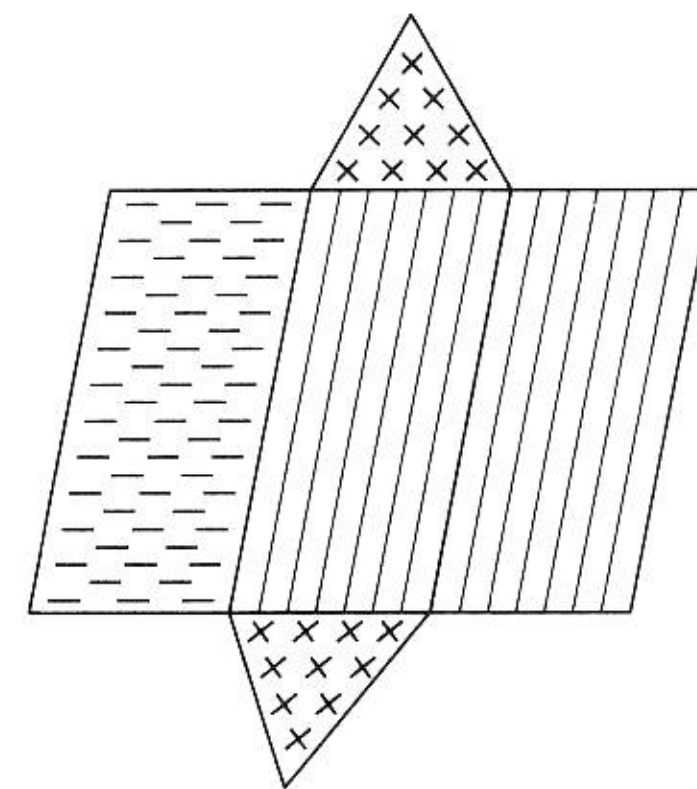

ข

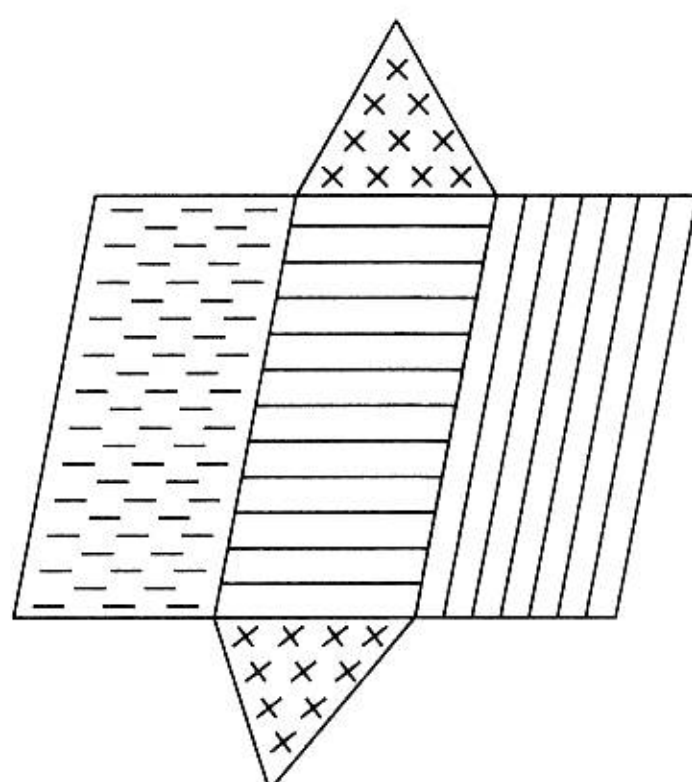

ค

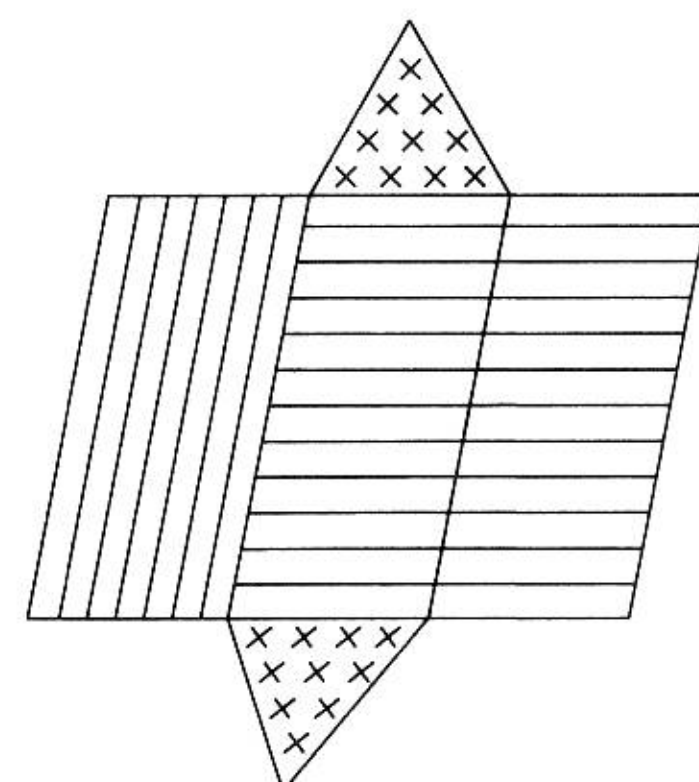

ง

10

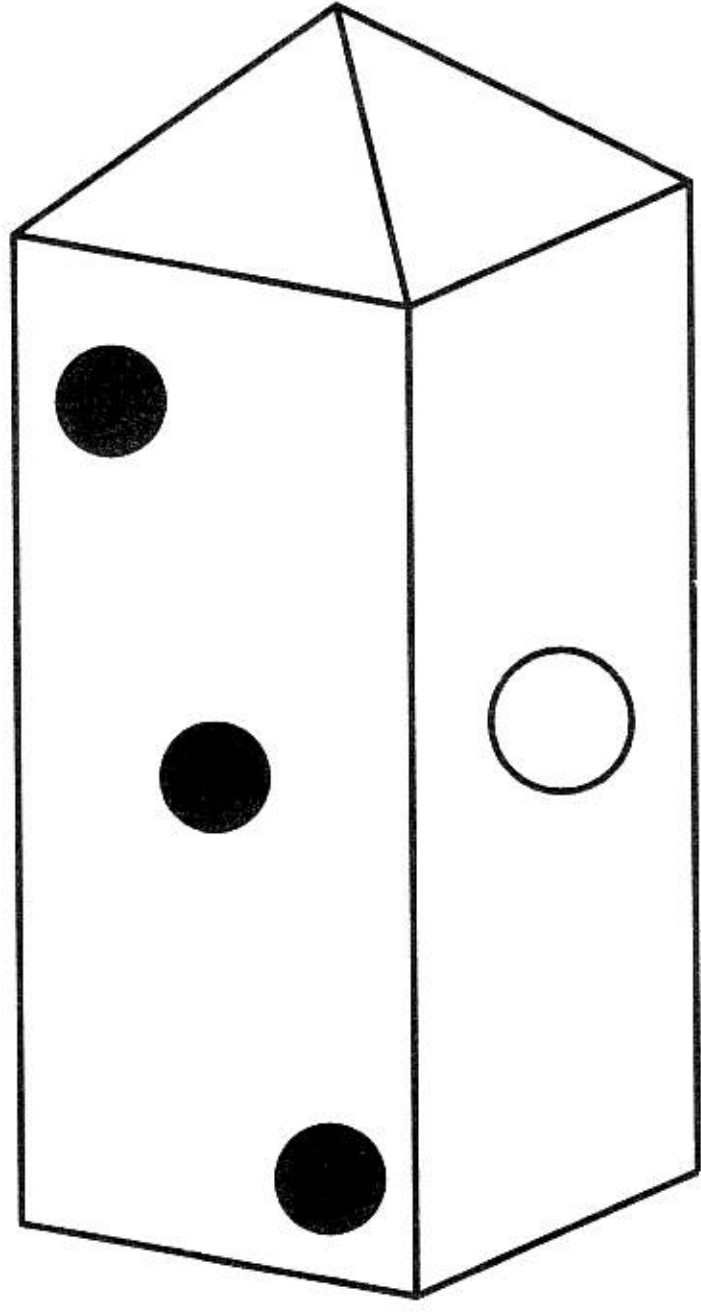

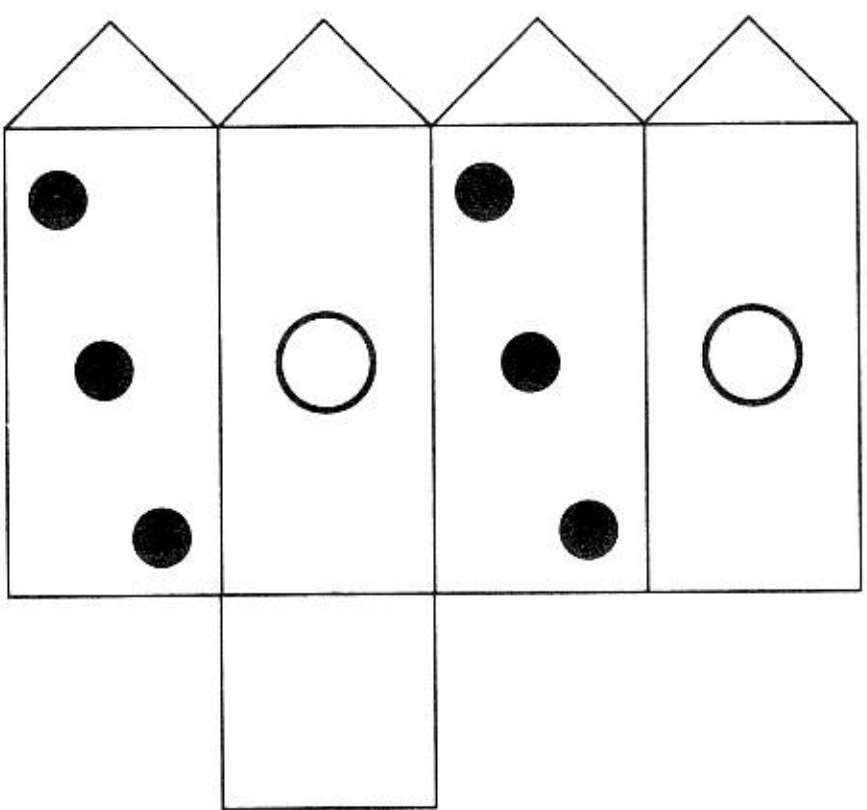
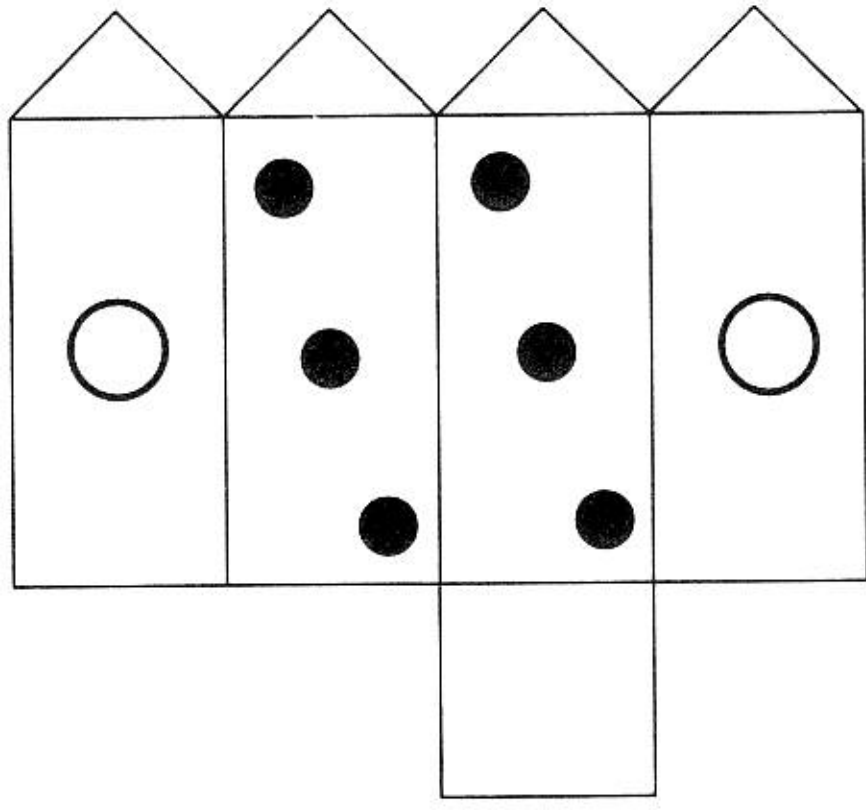
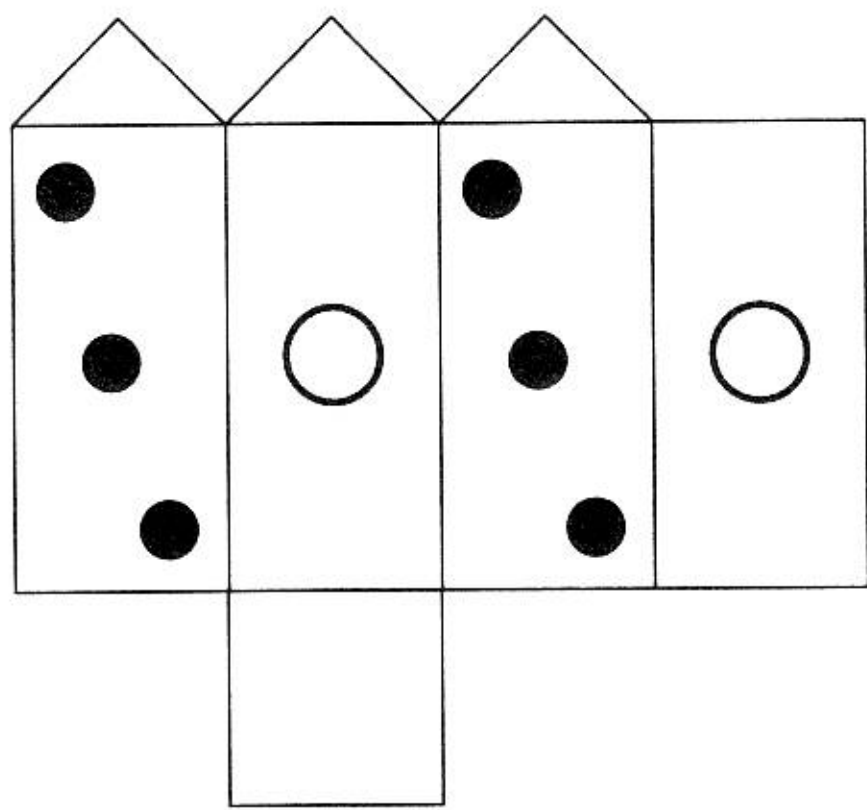
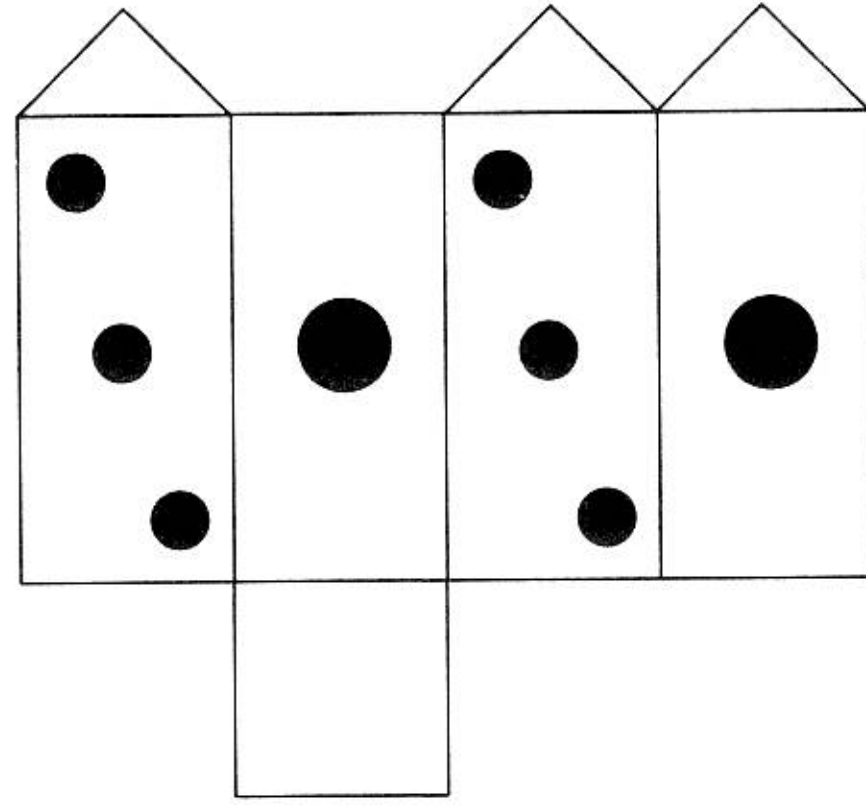
 <p>ก</p>	 <p>ข</p>
 <p>ค</p>	 <p>ง</p>

11

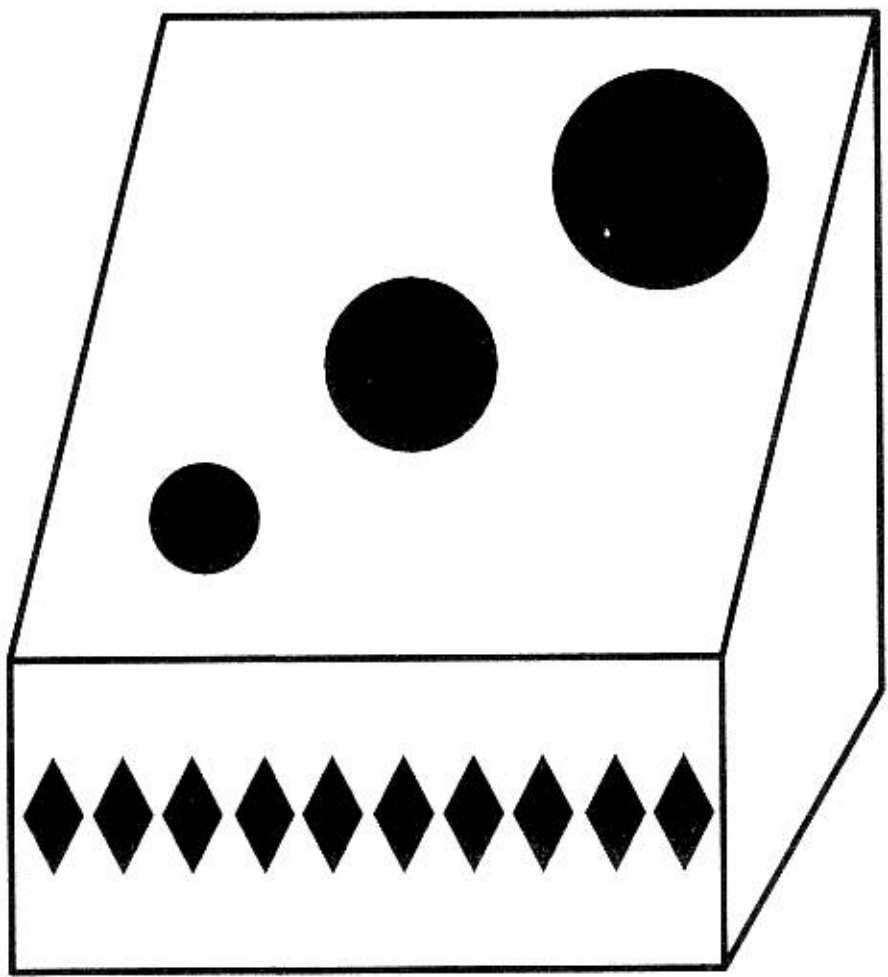

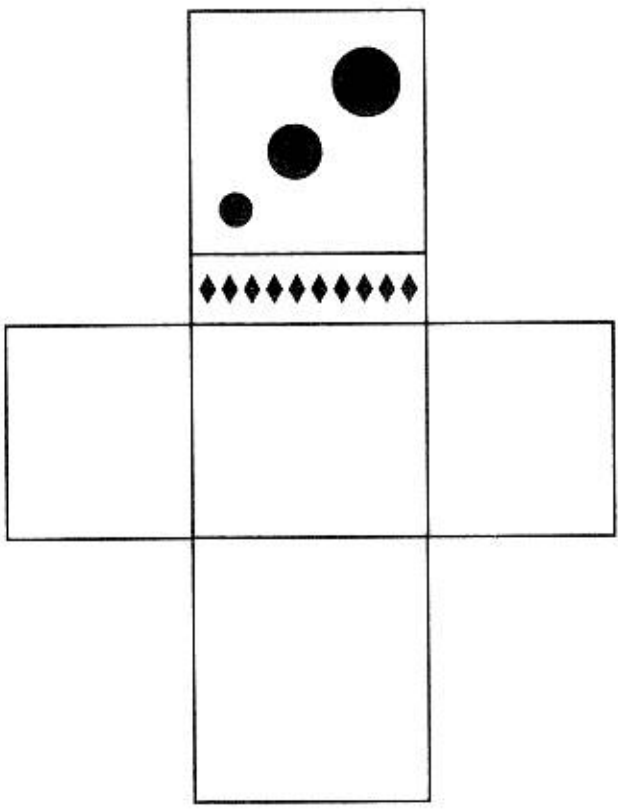
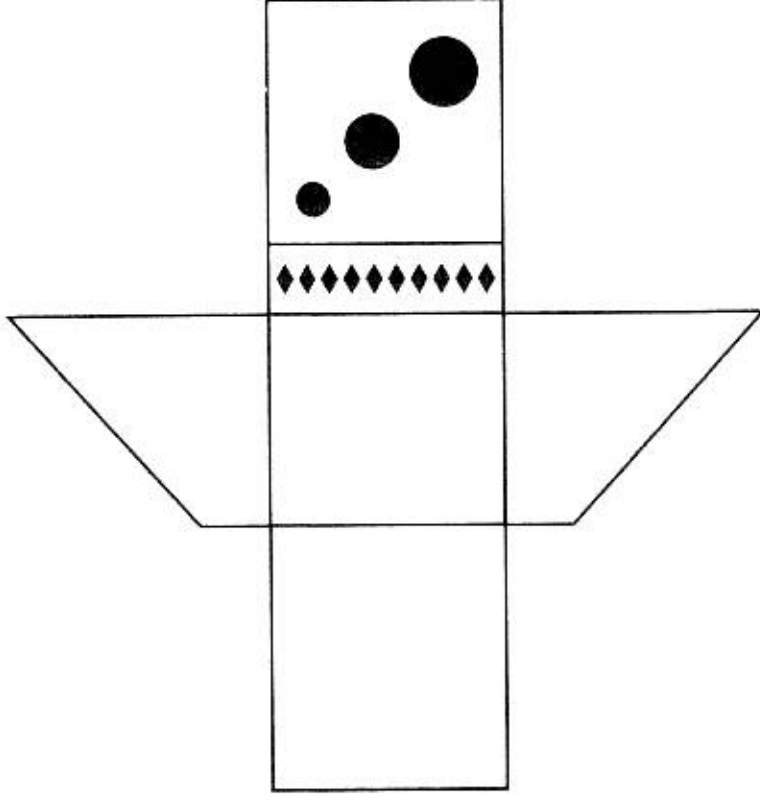
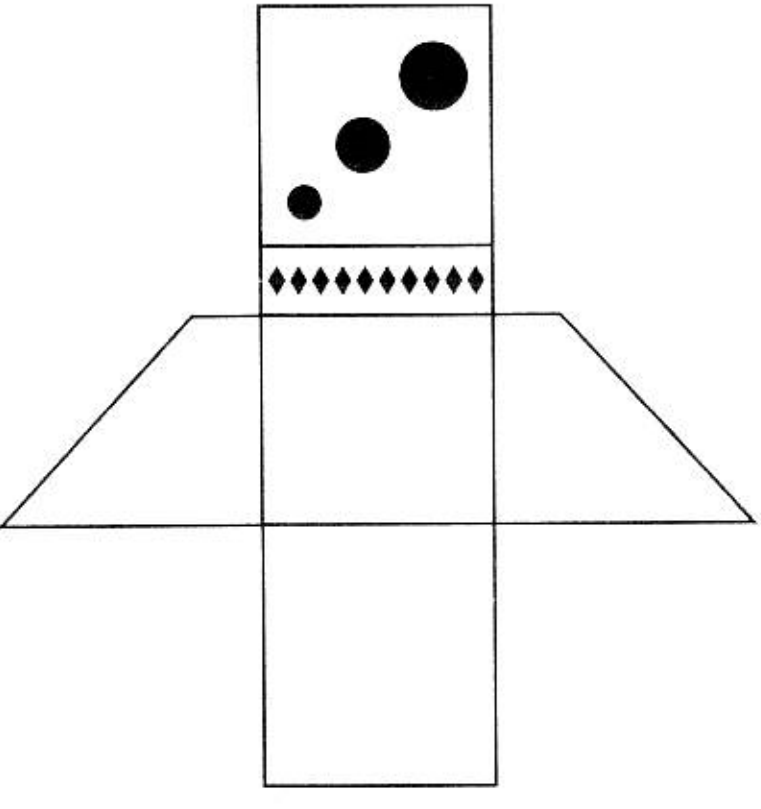
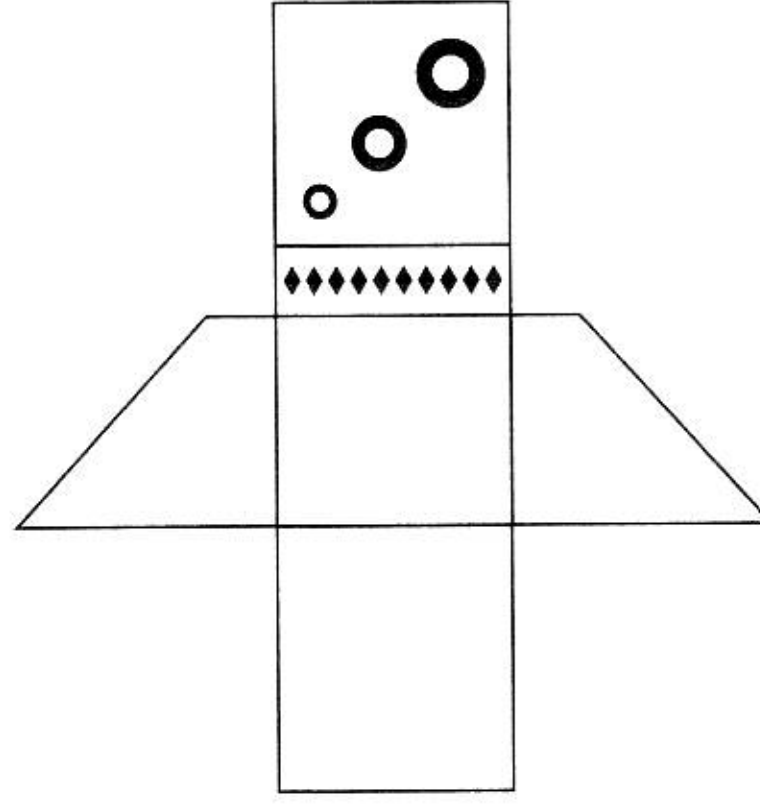
 <p>ก</p>	 <p>ข</p>
 <p>ค</p>	 <p>ง</p>

12

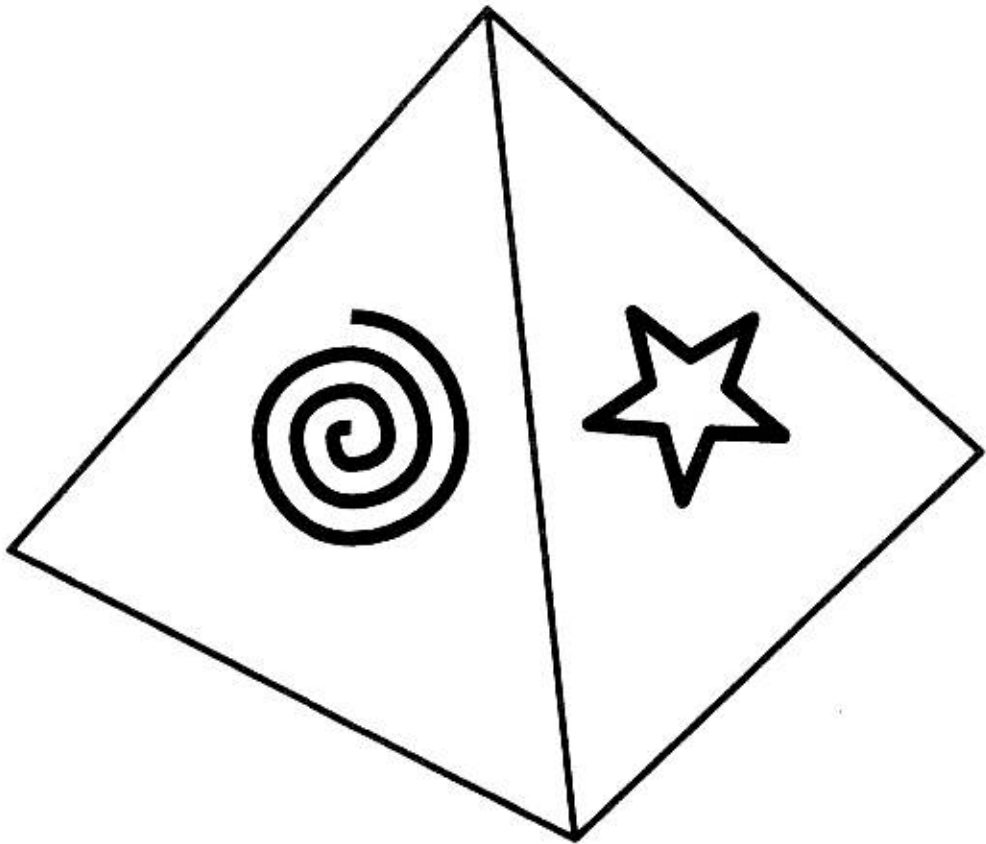

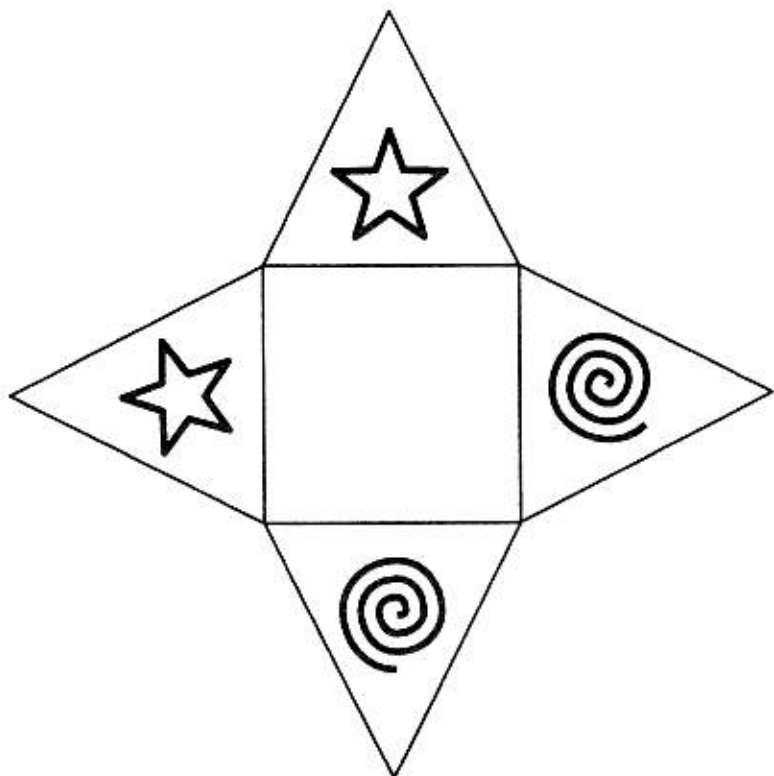
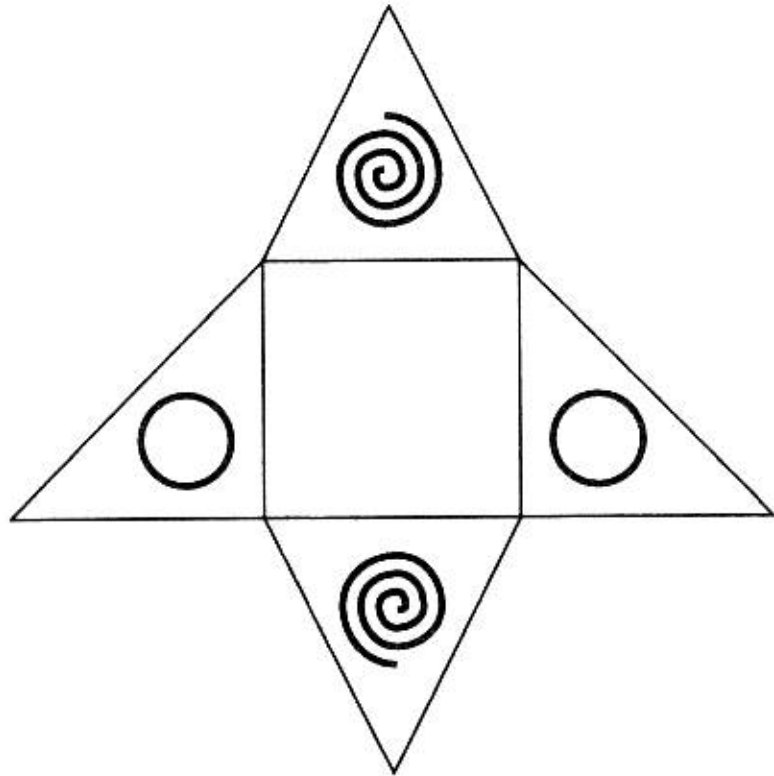
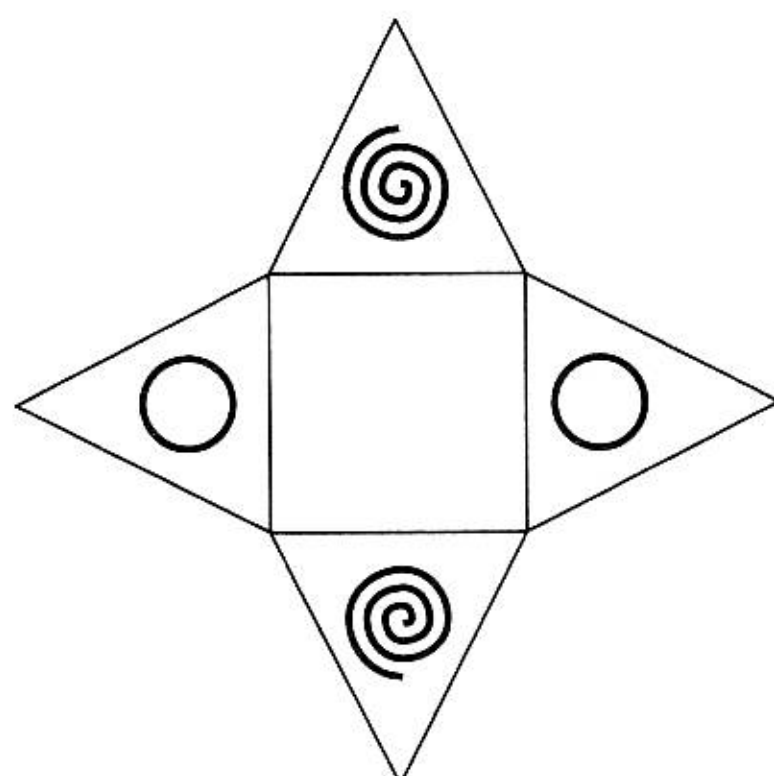
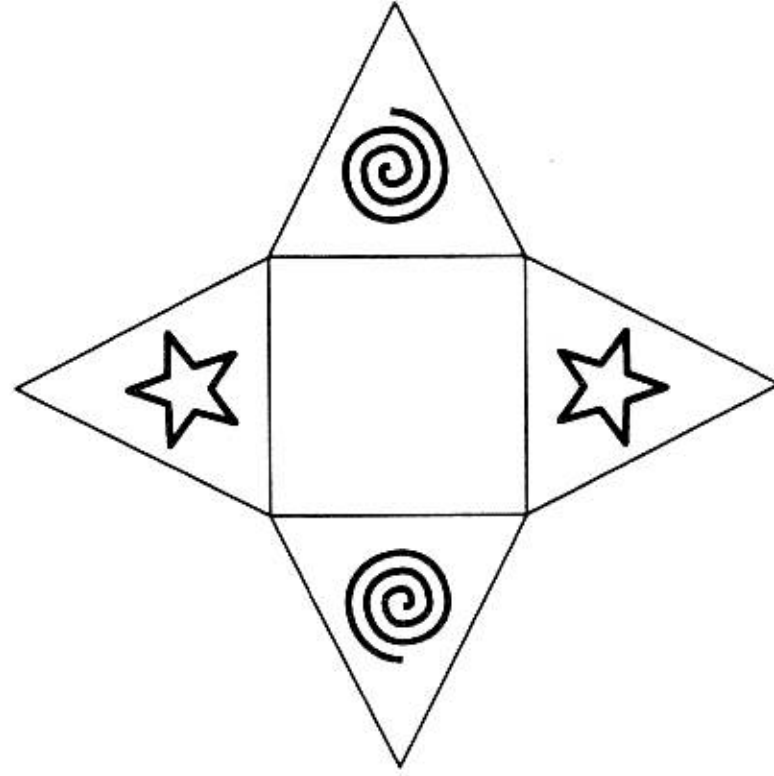
 <p>ก</p>	 <p>ข</p>
 <p>ค</p>	 <p>ง</p>

13

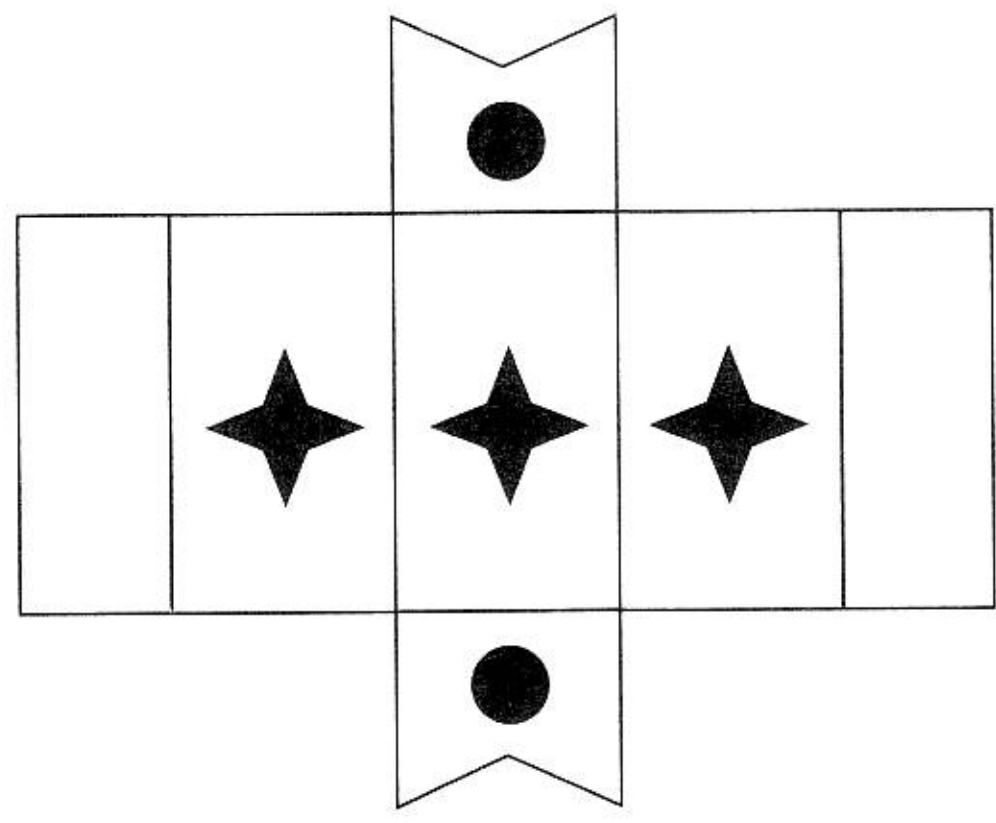
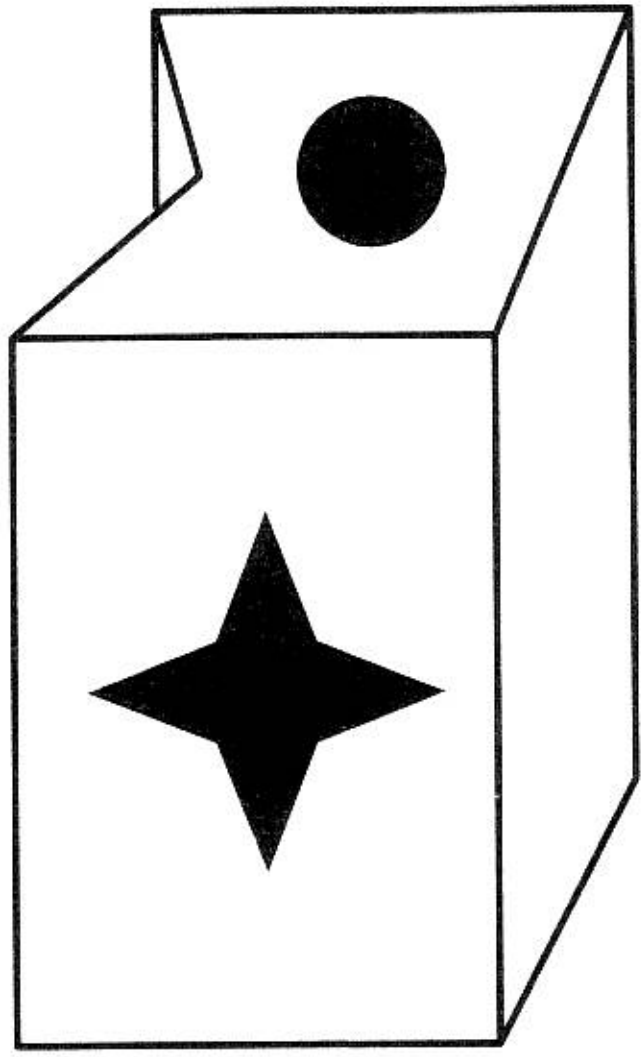

ก

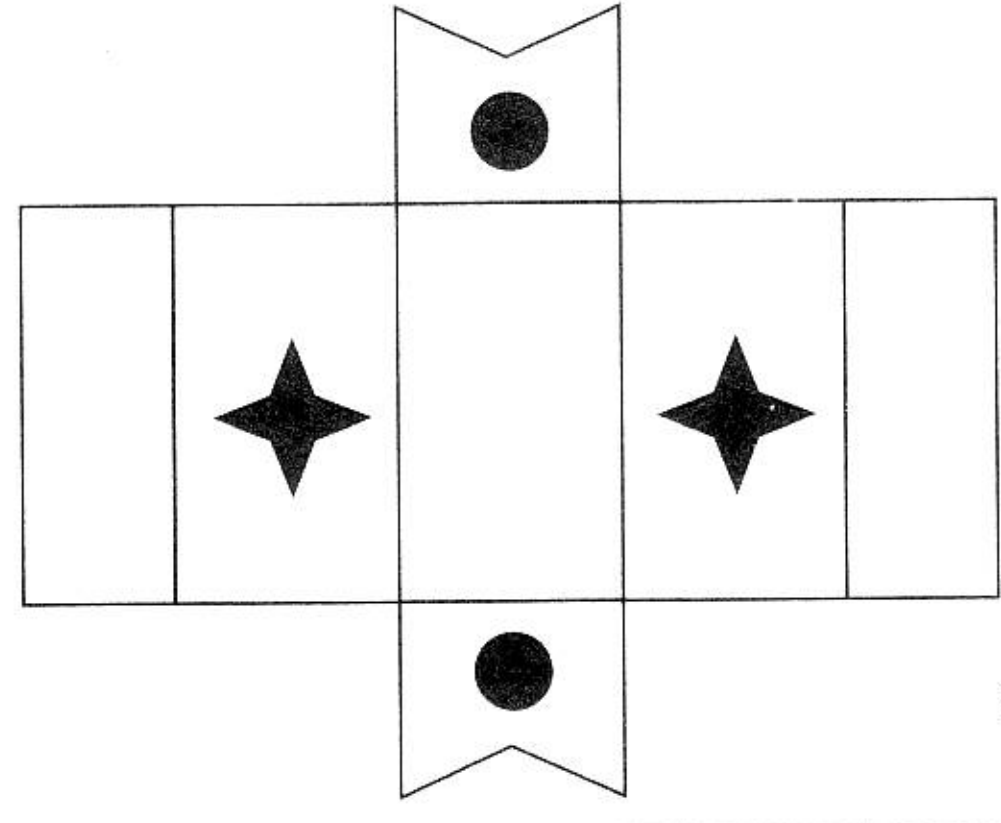

ข

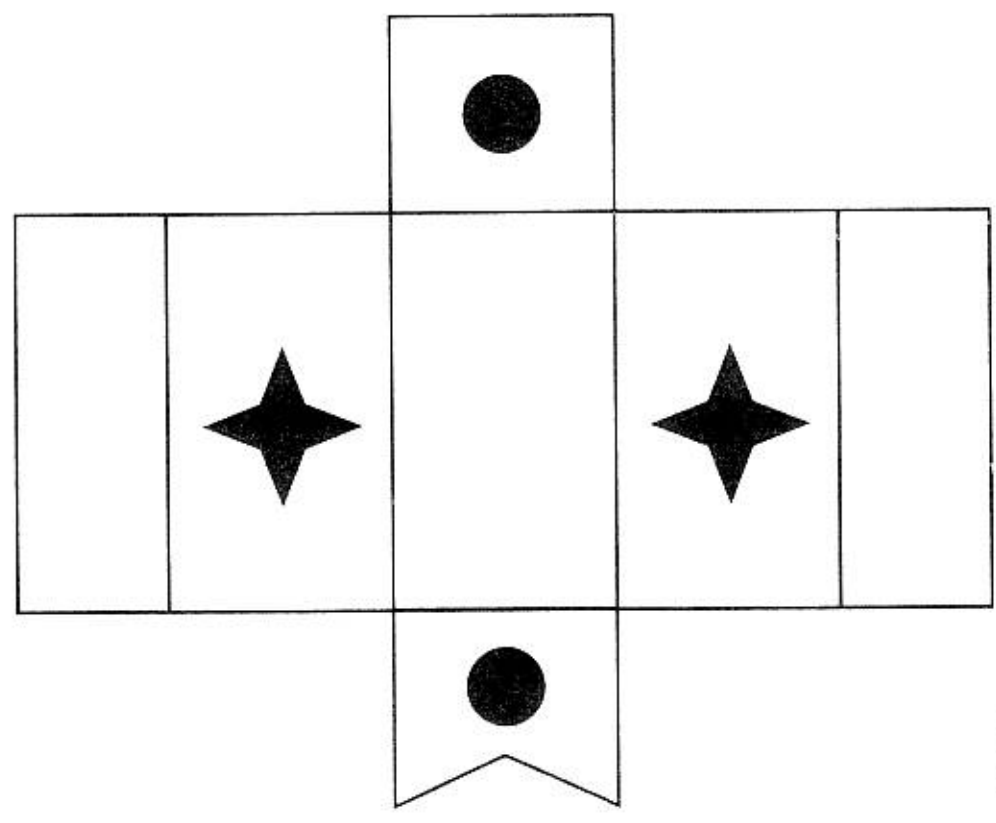

ค

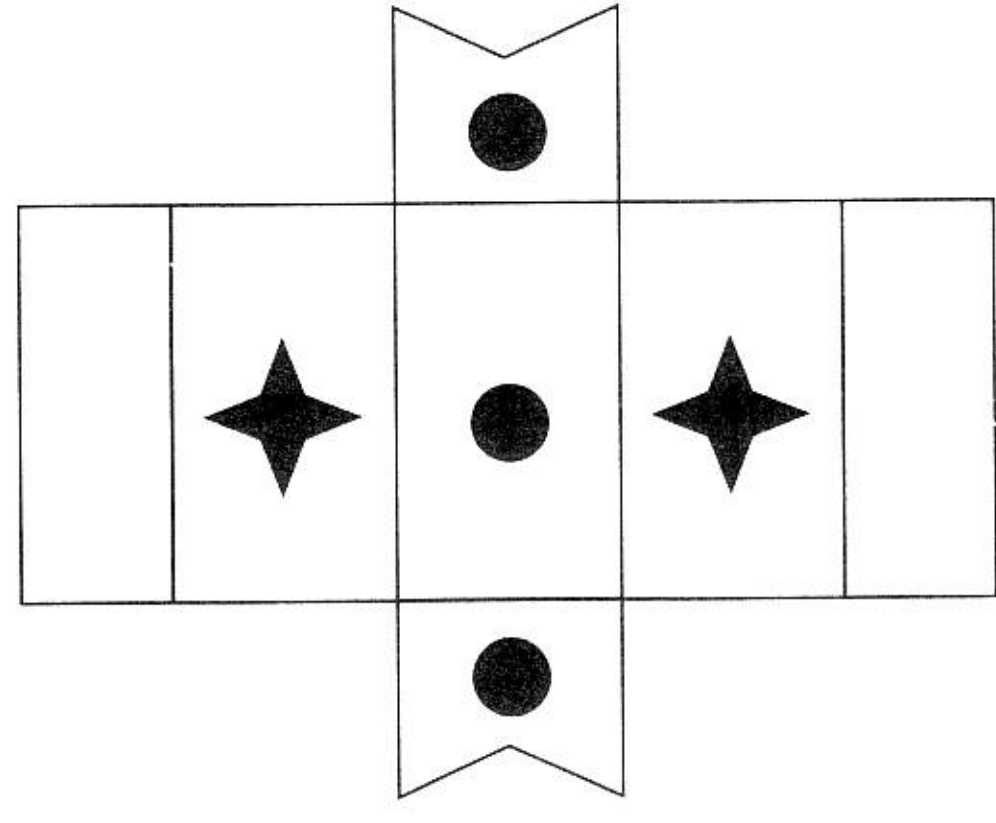

ง

14

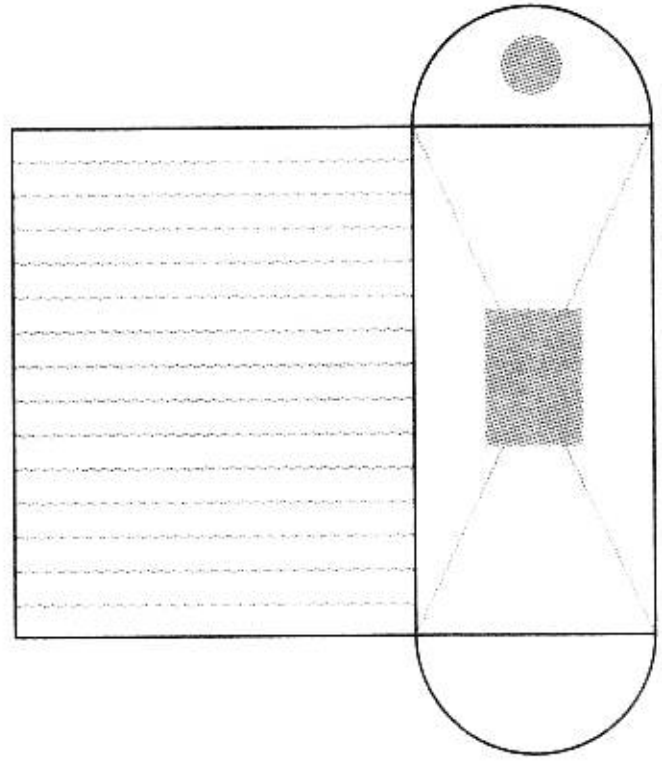
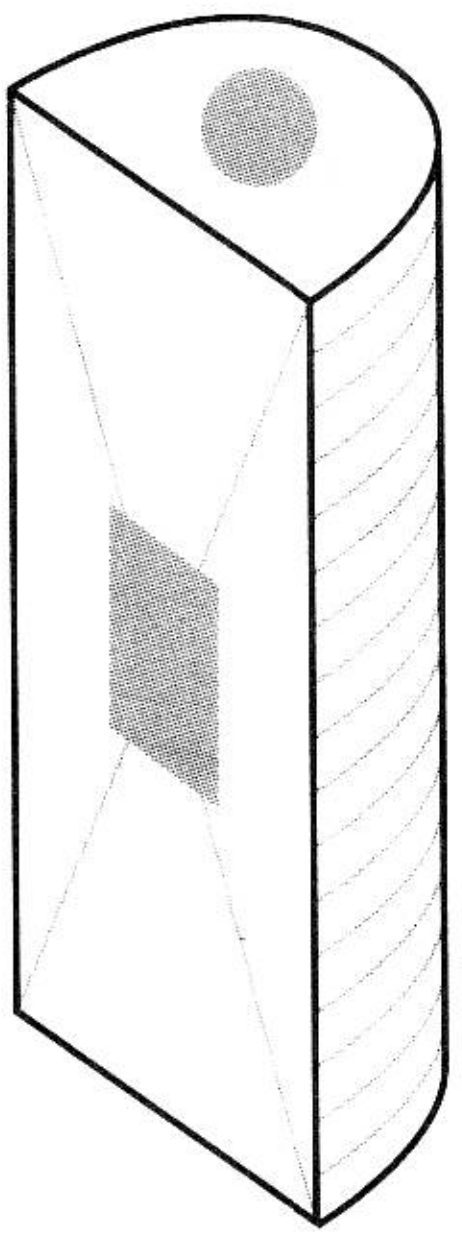

ก

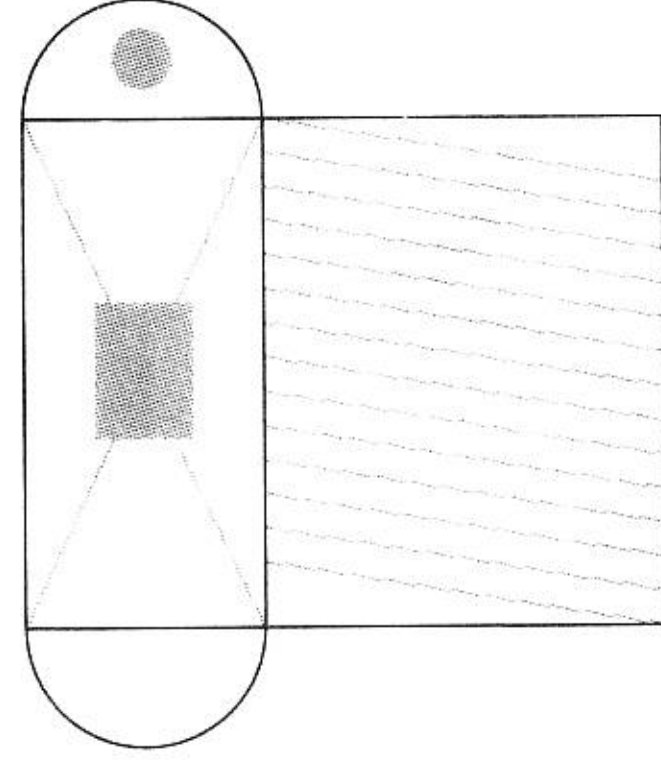

ข

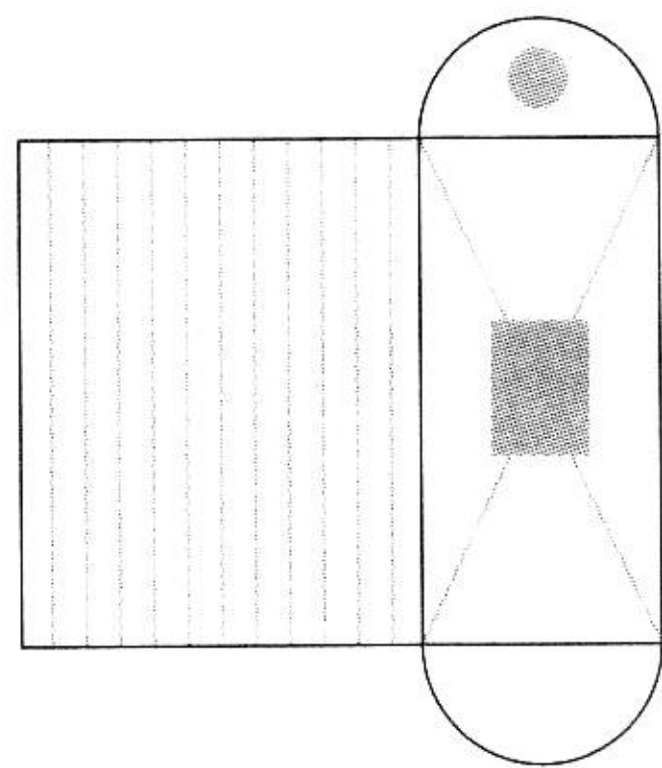

ค

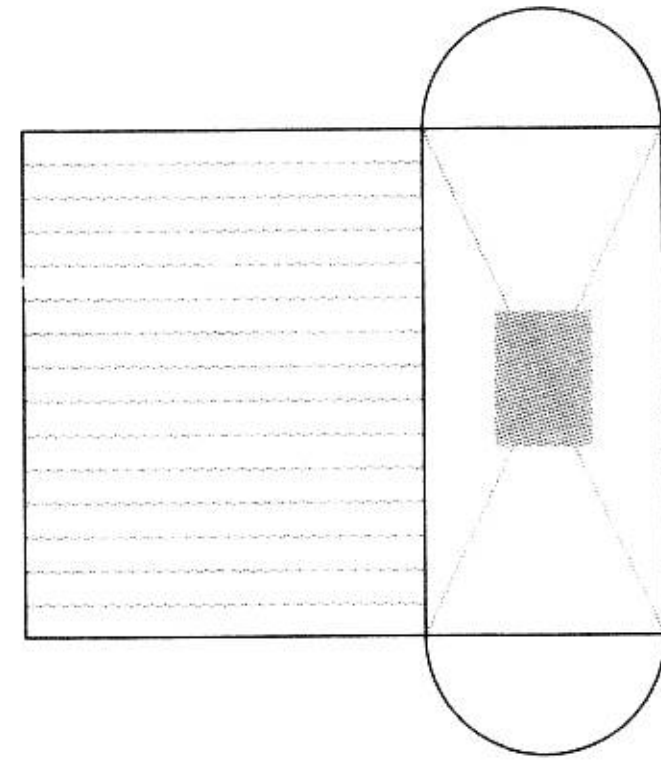

ง

15

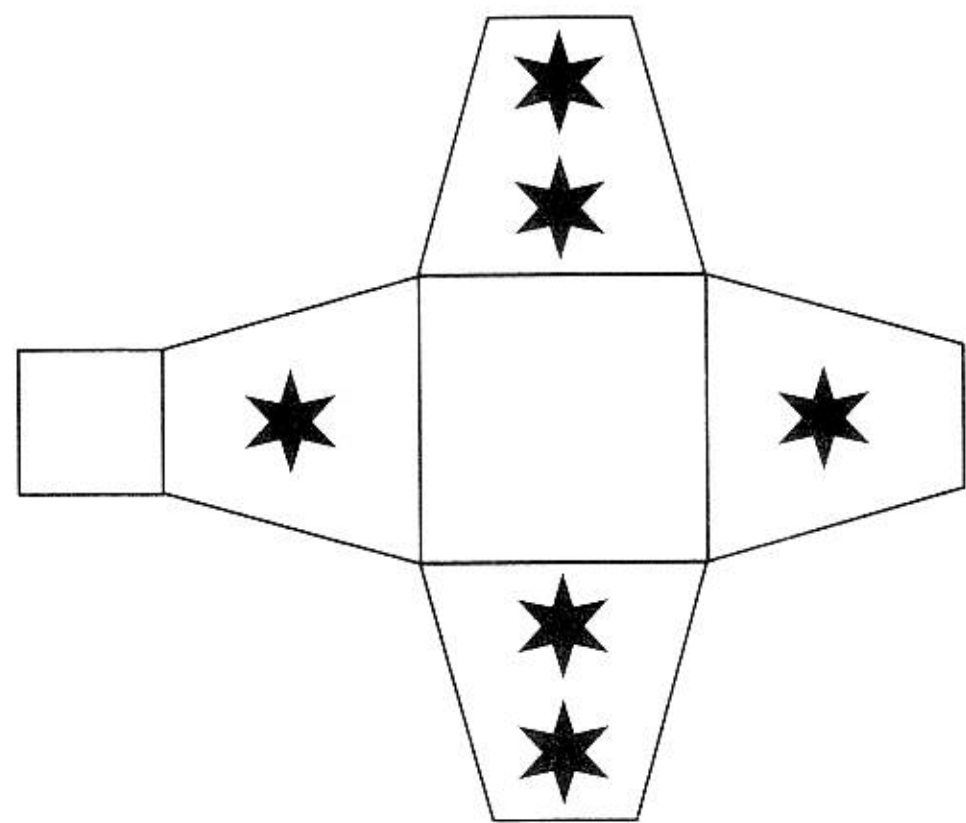
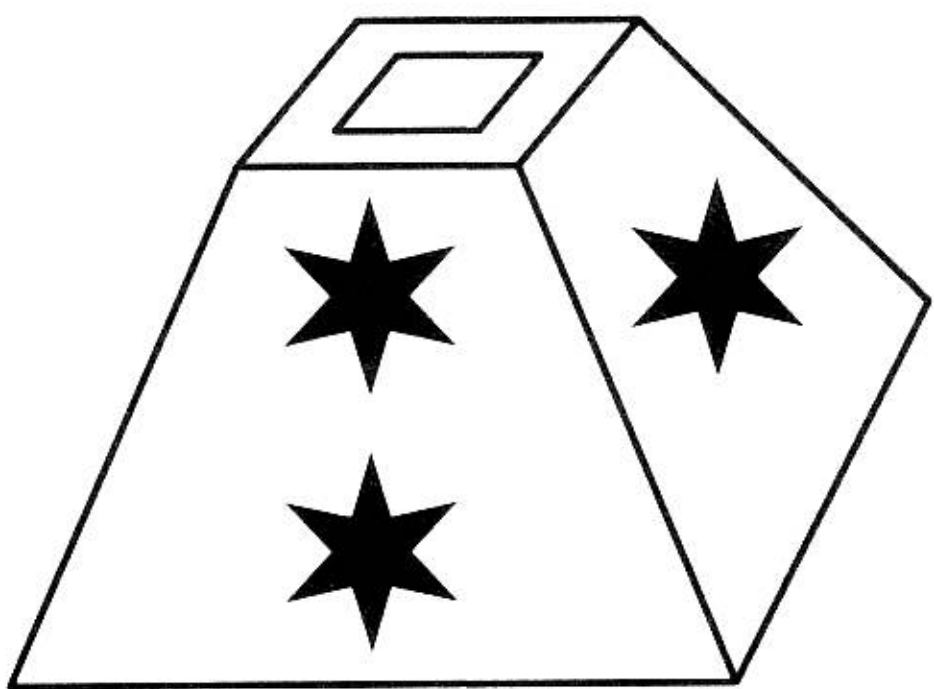

ก

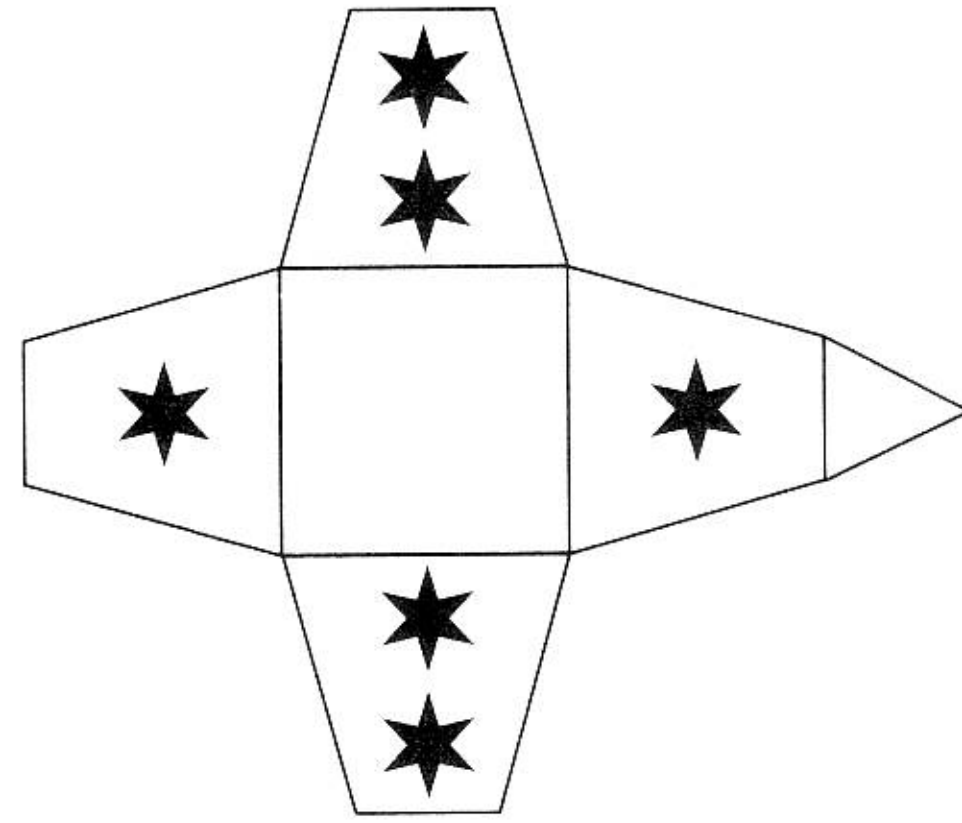

ข

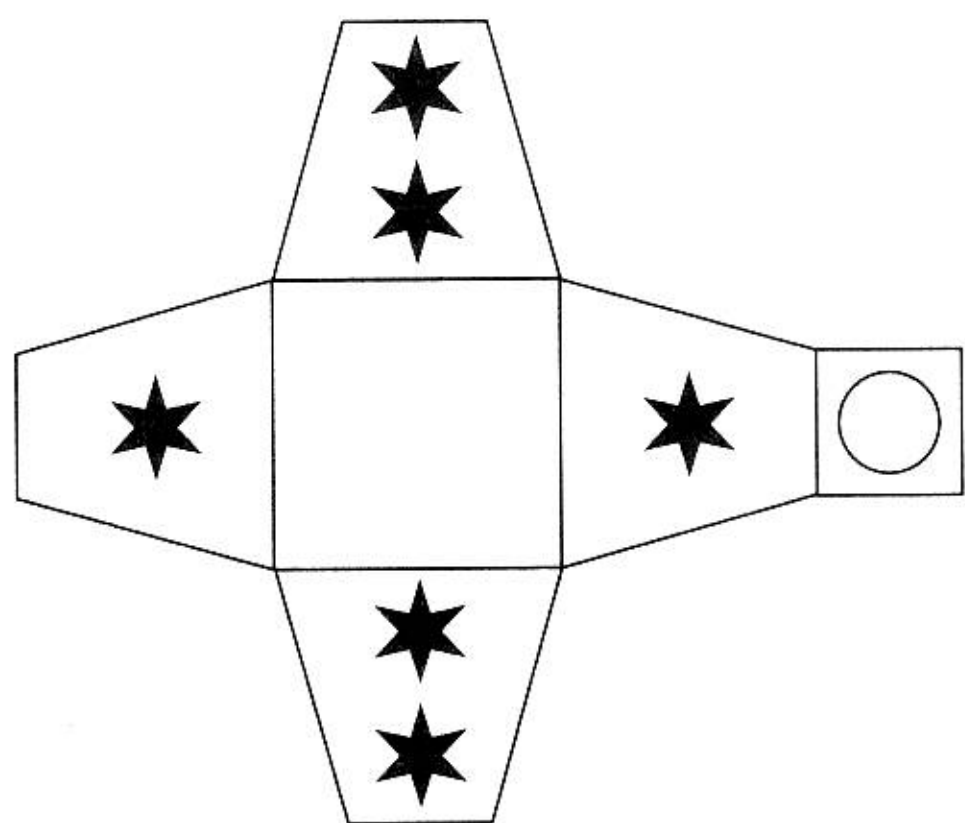

ค

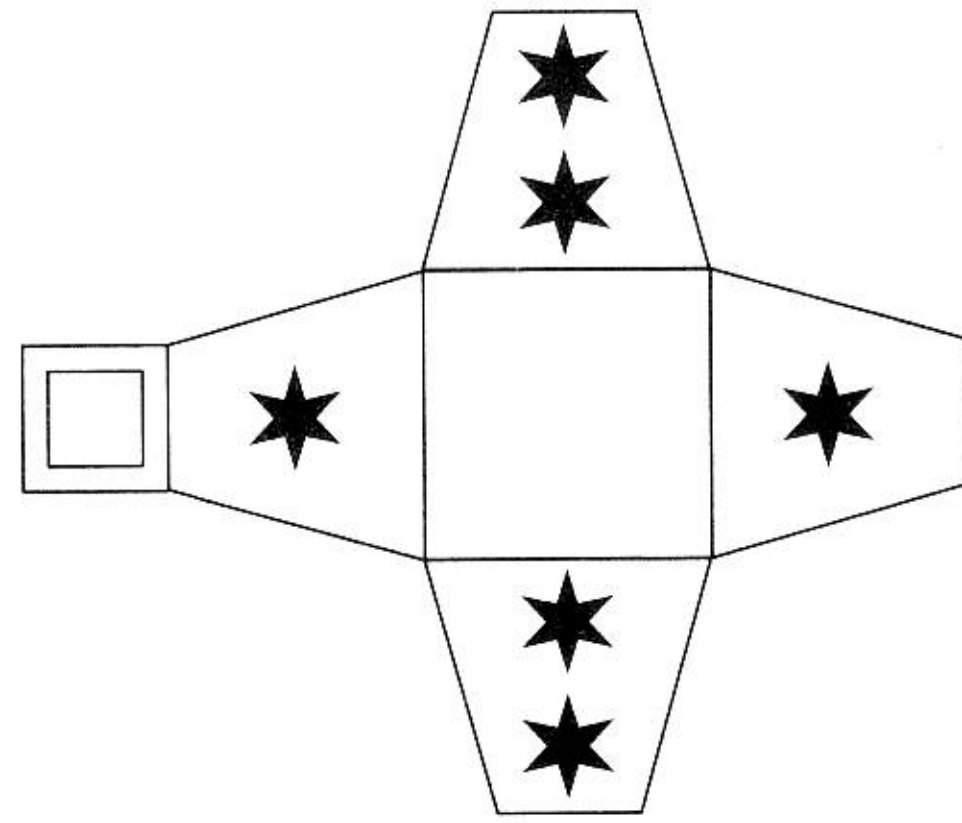

ง

# ตอนที่ 4

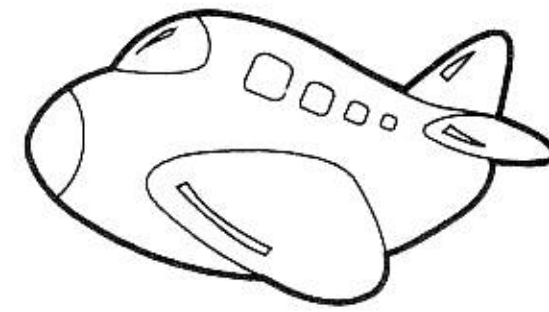

## การเปรียบเทียบ ปริมาณ น้ำหนัก ระยะทาง พื้นที่

- การเปรียบเทียบปริมาณ 15 ข้อ
- การเปรียบเทียบน้ำหนัก 15 ข้อ
- การเปรียบเทียบระยะทาง 15 ข้อ
- การเปรียบเทียบขนาดพื้นที่ 15 ข้อ

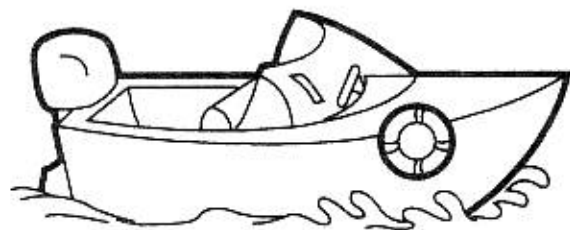

หาความสัมพันธ์ของปริมาณน้ำที่กำหนดในภาพแรก โดย ✓

**1** ภาพใดแสดงการรินน้ำจากแก้วลงในอ่างอย่างถูกวิธี

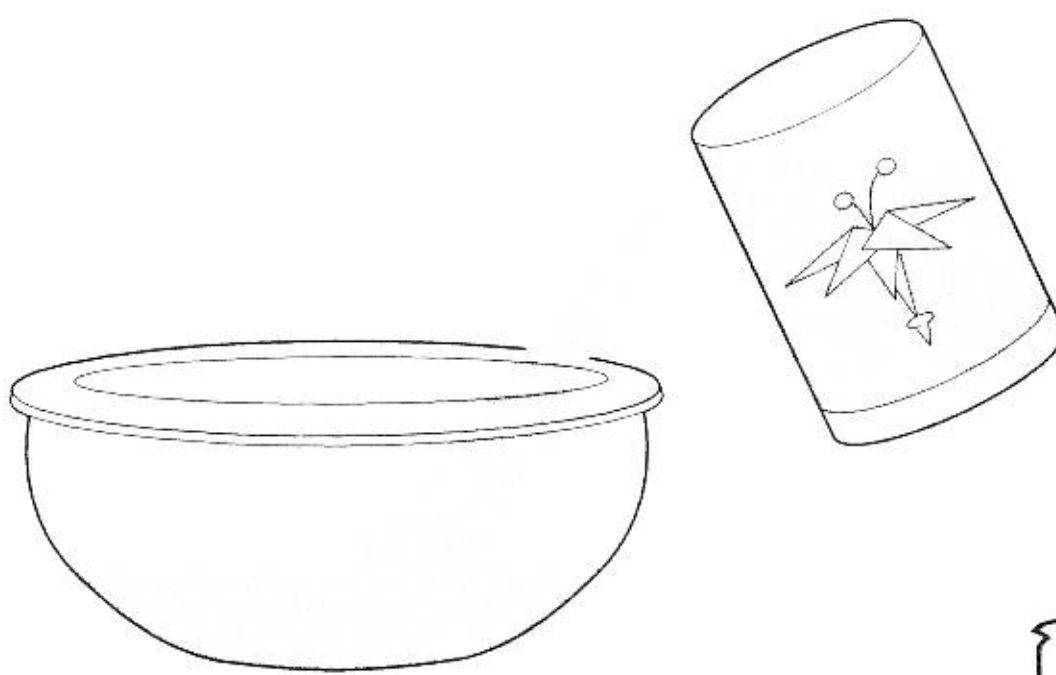
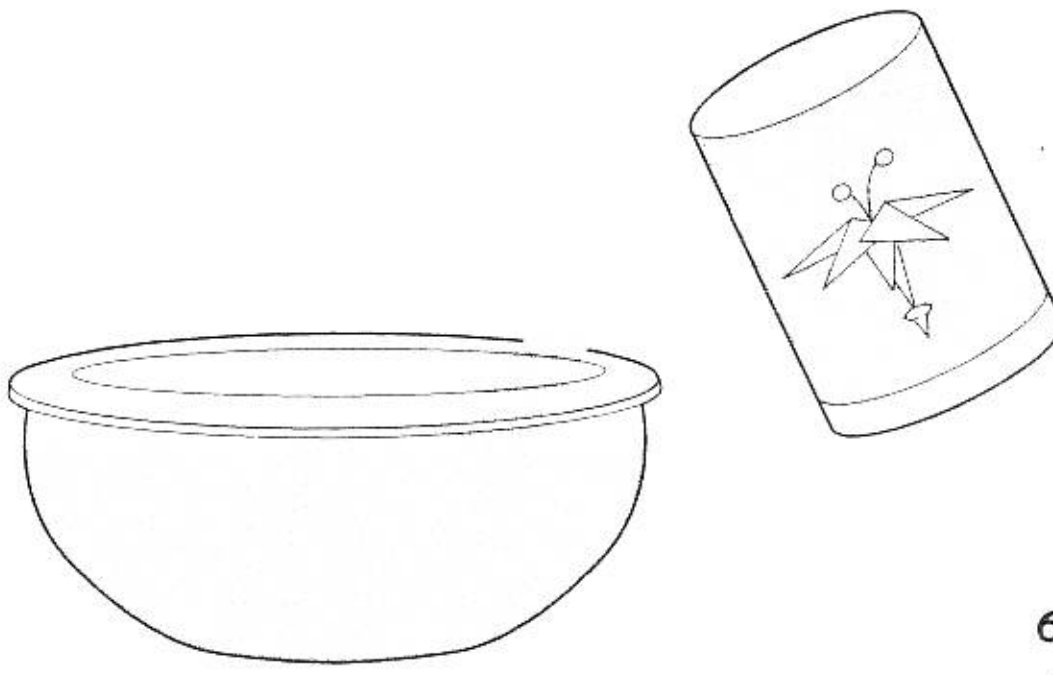
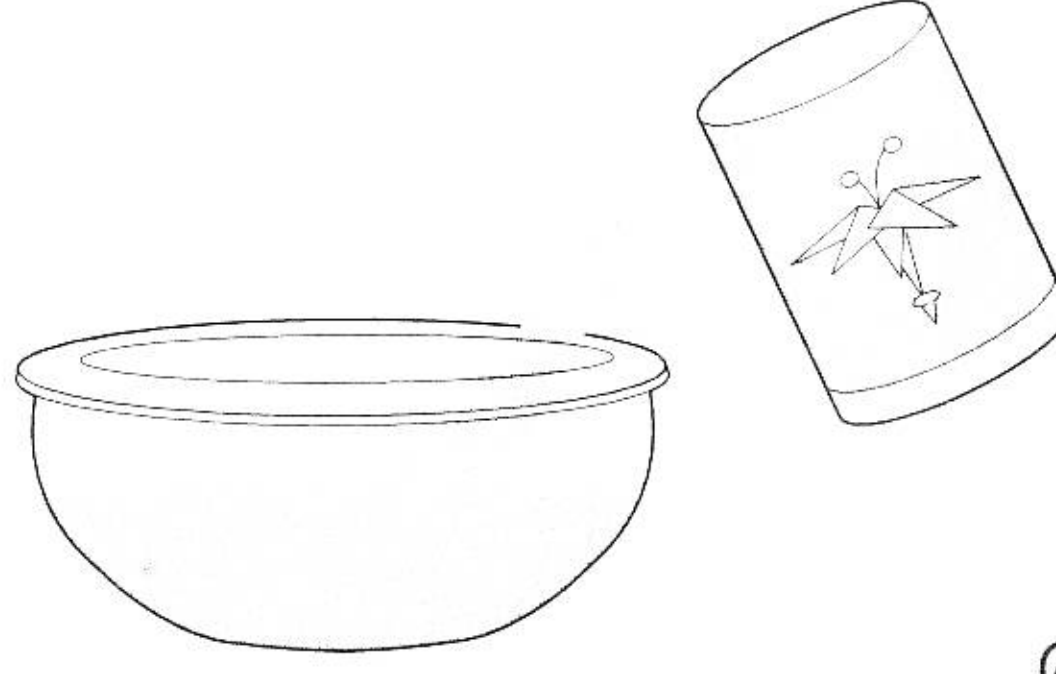
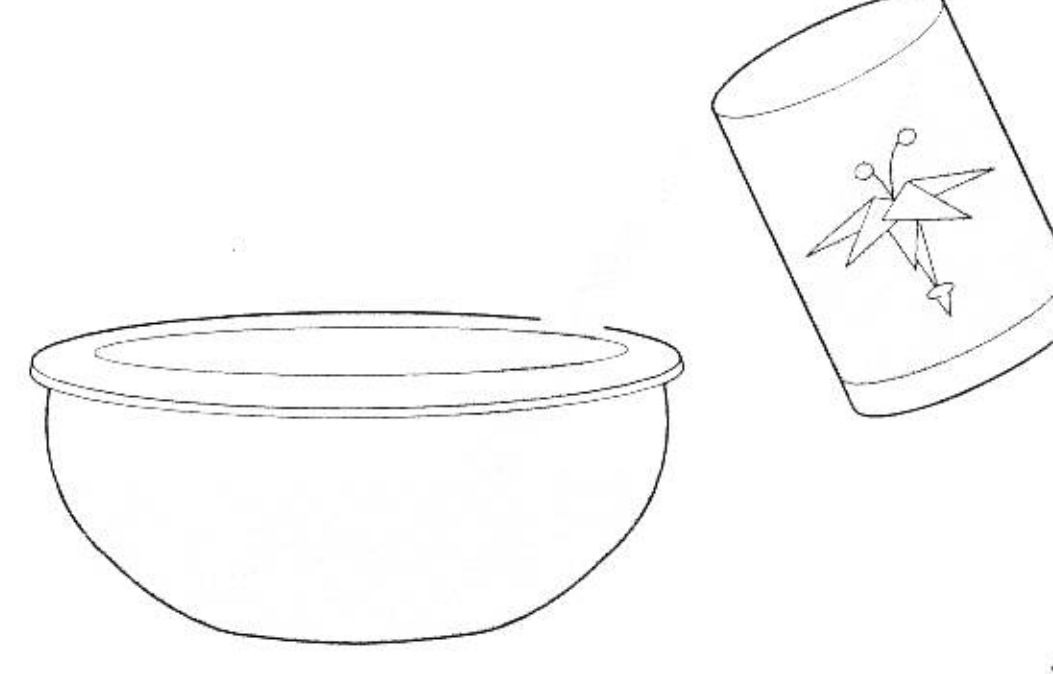

 <p>ก</p>	 <p>ข</p>
 <p>ค</p>	 <p>ง</p>

**2** น้ำในแก้ว ข้อใดเท่ากับภาพแรก

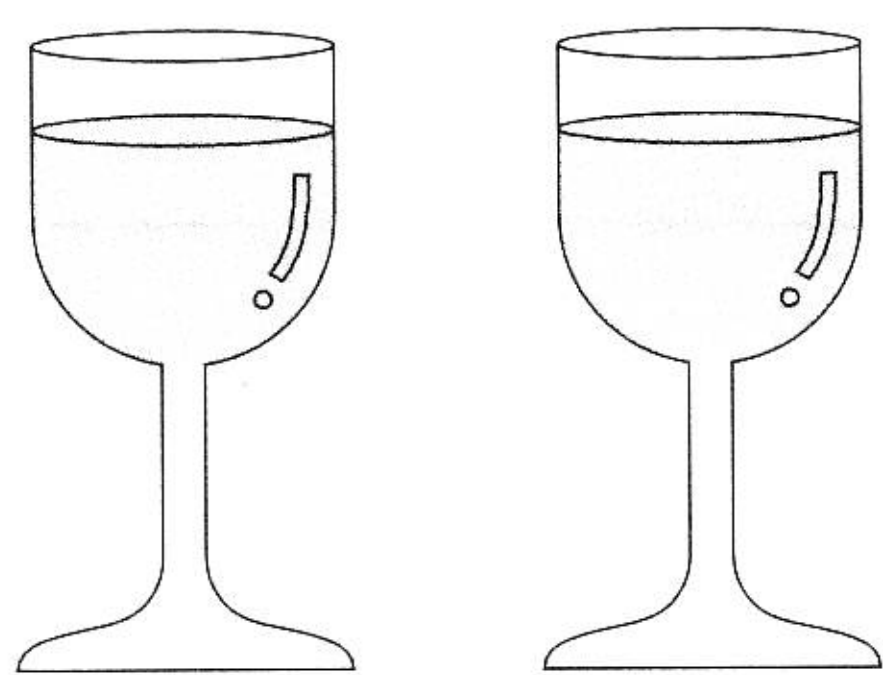

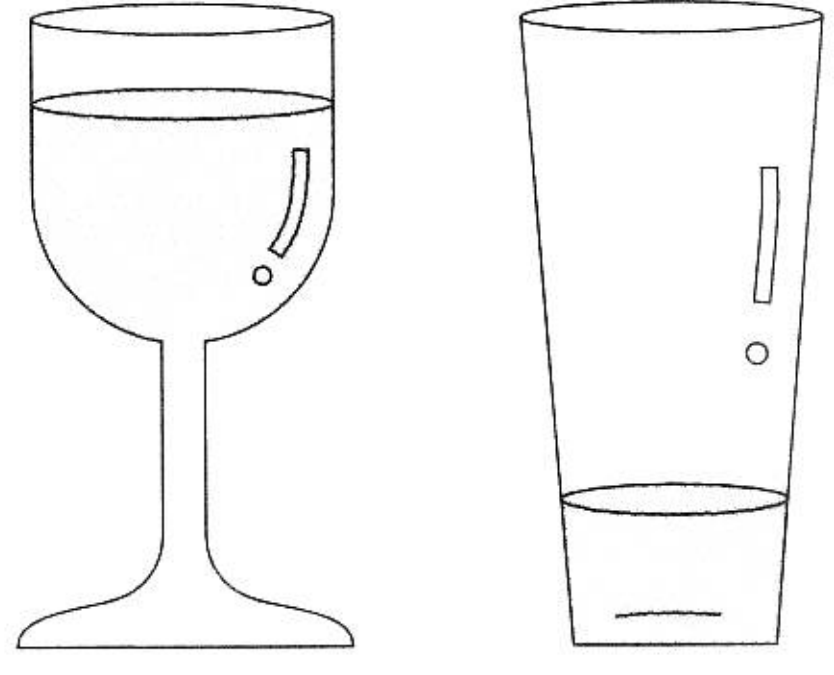
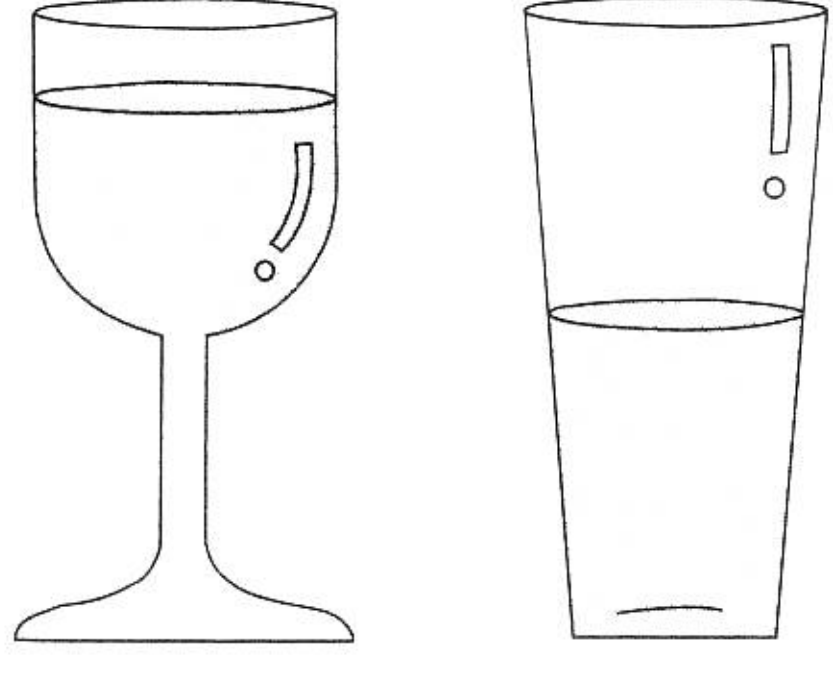
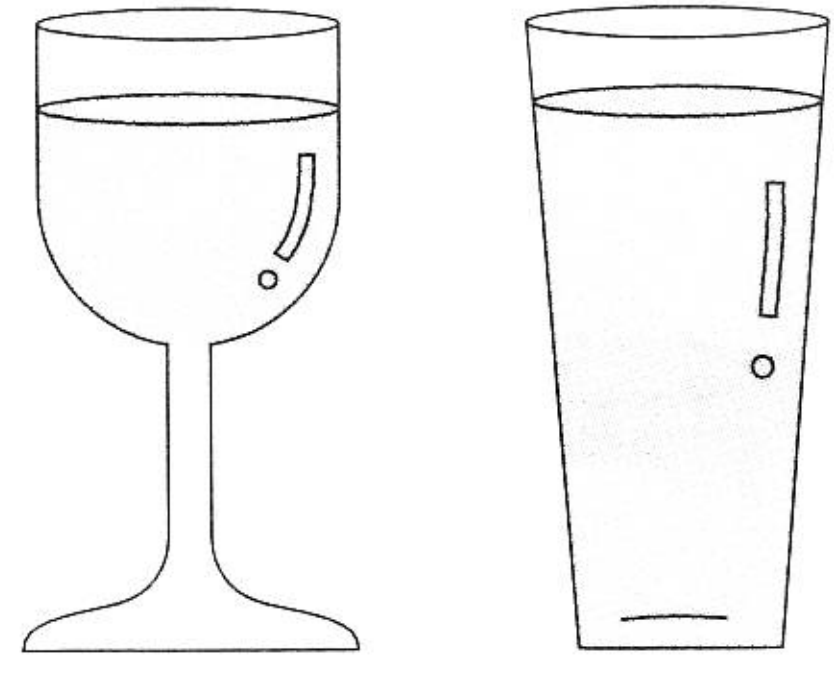
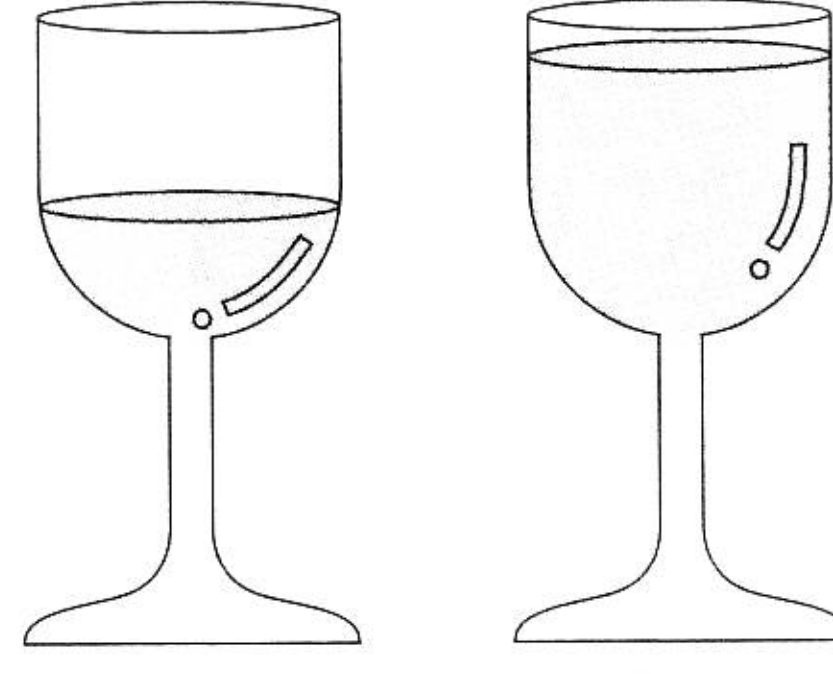
 <p>ก</p>	 <p>ข</p>
 <p>ค</p>	 <p>ง</p>

**3** น้ำในแก้ว ข้อใดมีปริมาณเท่ากับภาพแรก

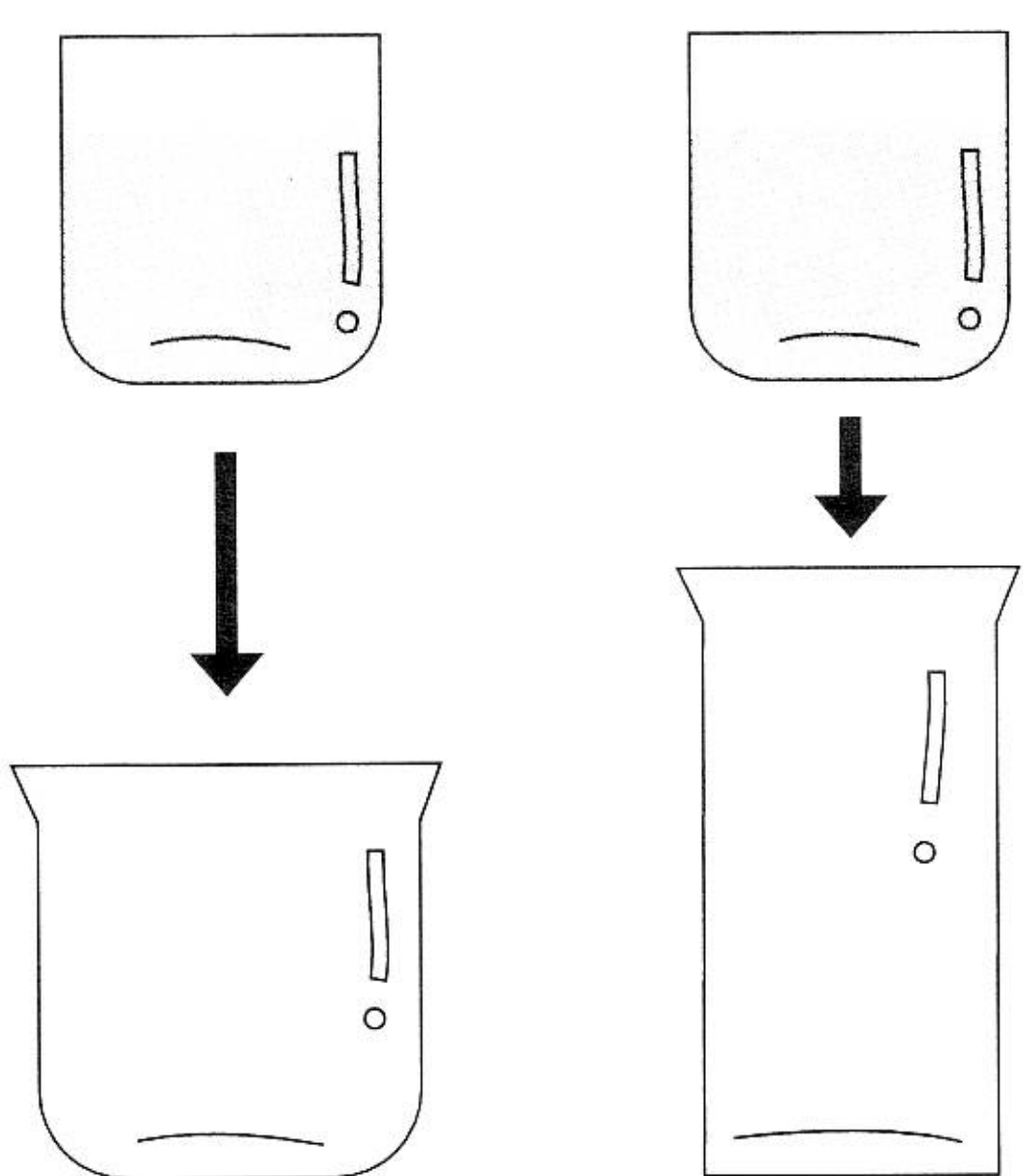

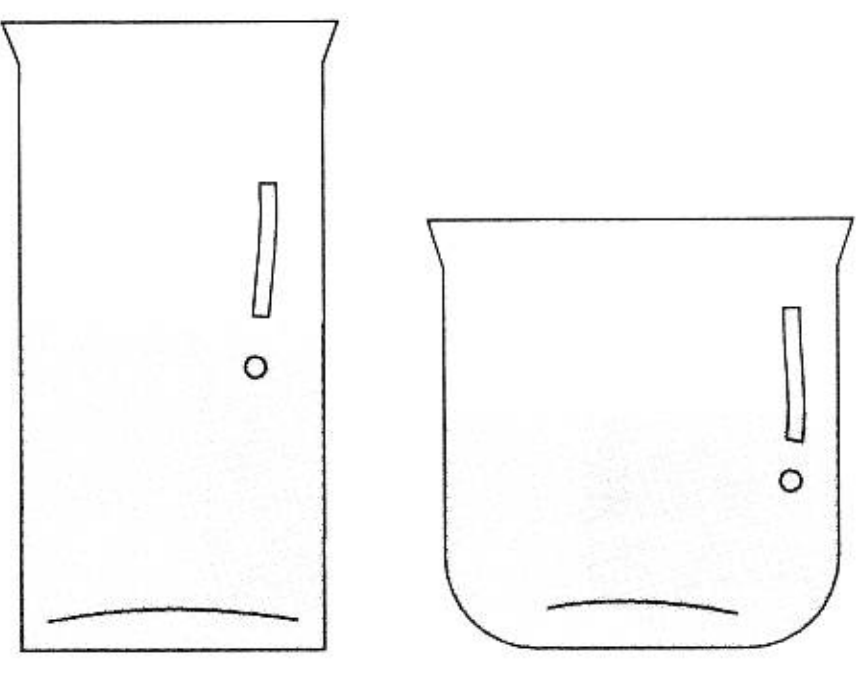
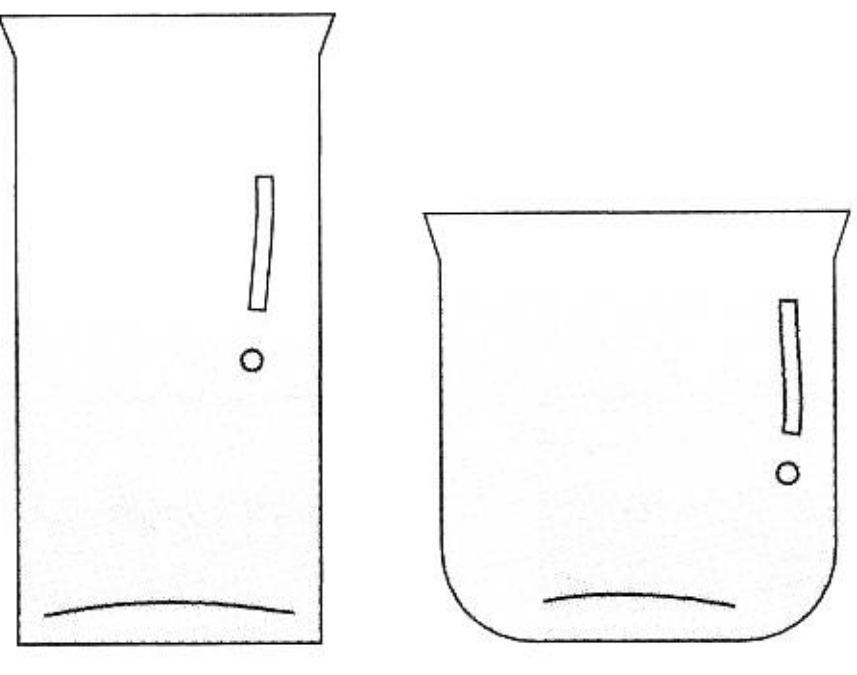
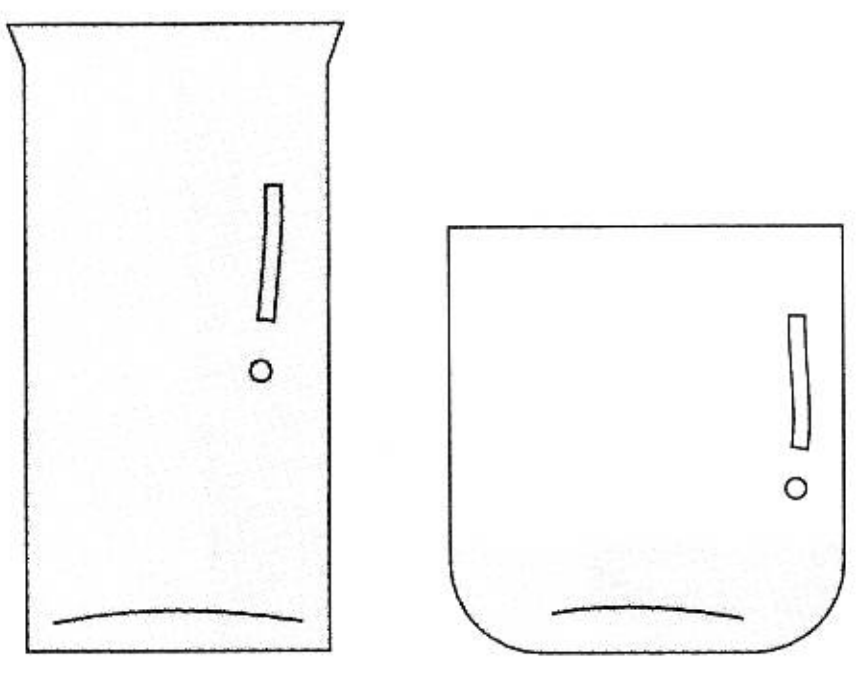
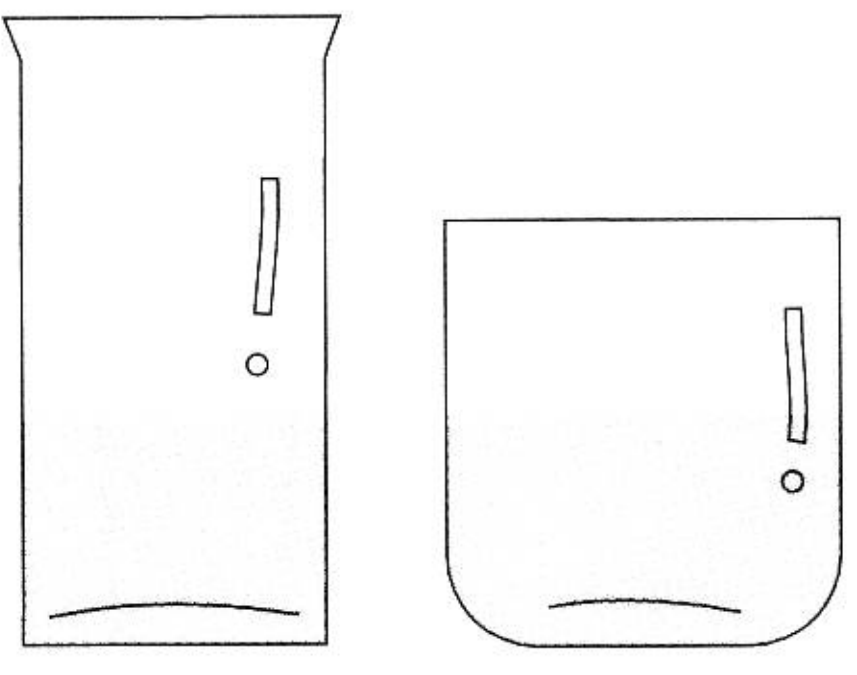
 <p>ก</p>	 <p>ข</p>
 <p>ค</p>	 <p>ง</p>

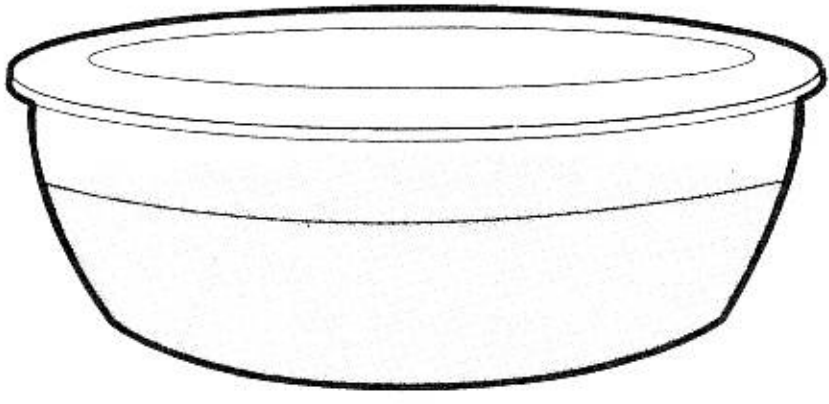
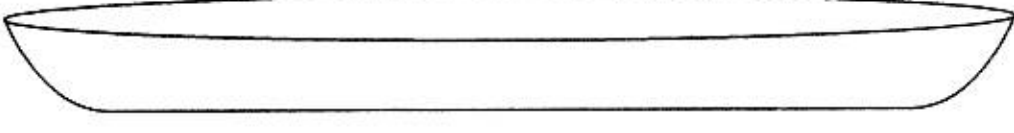
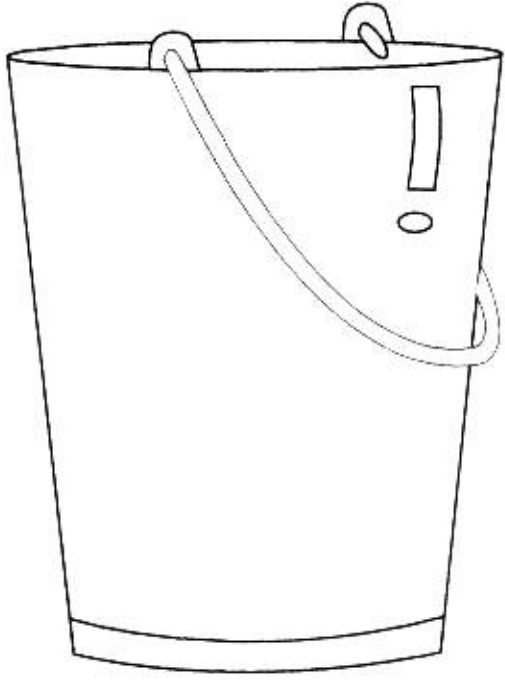
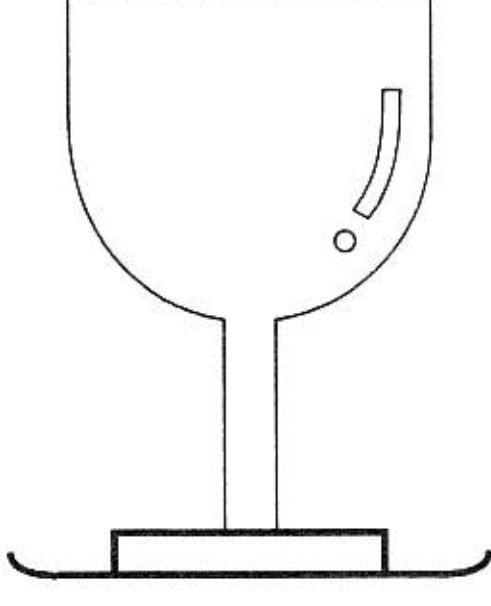
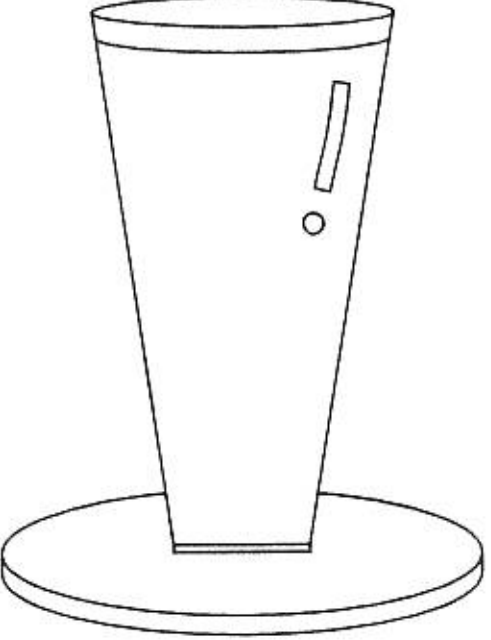

4 เหน้่าลงภาชนะใดได้โดยไม่ล้น

	 ก	 ข
	 ค	 ง

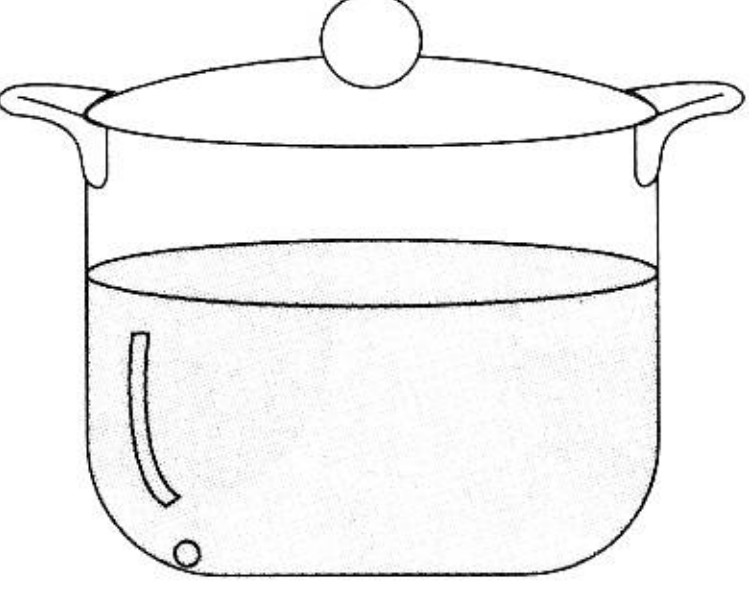
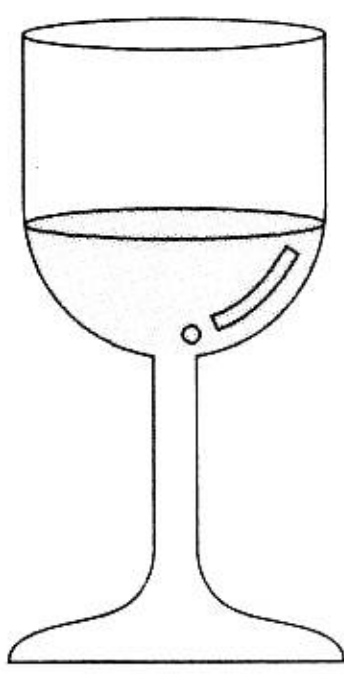
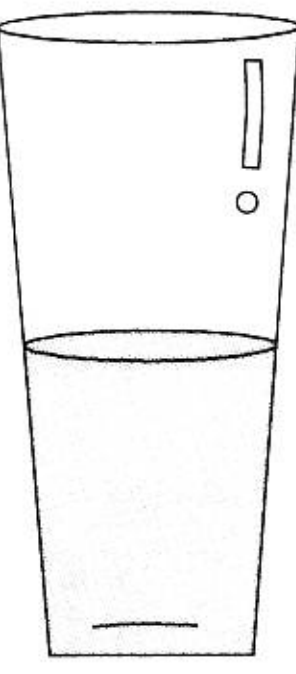
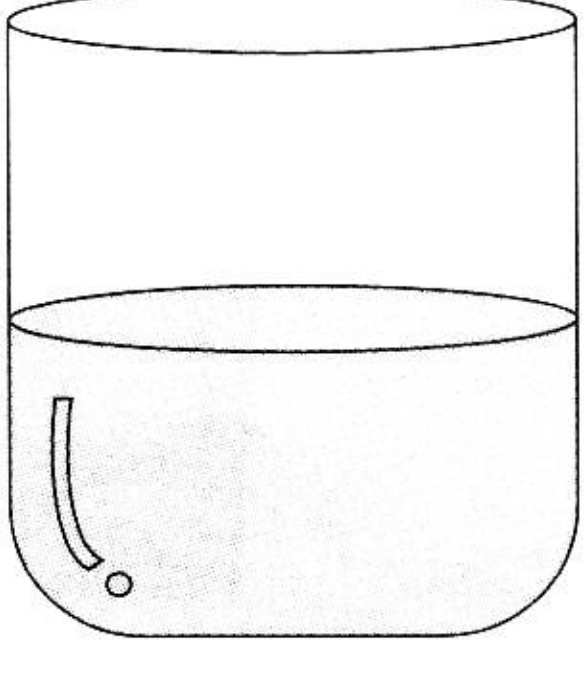
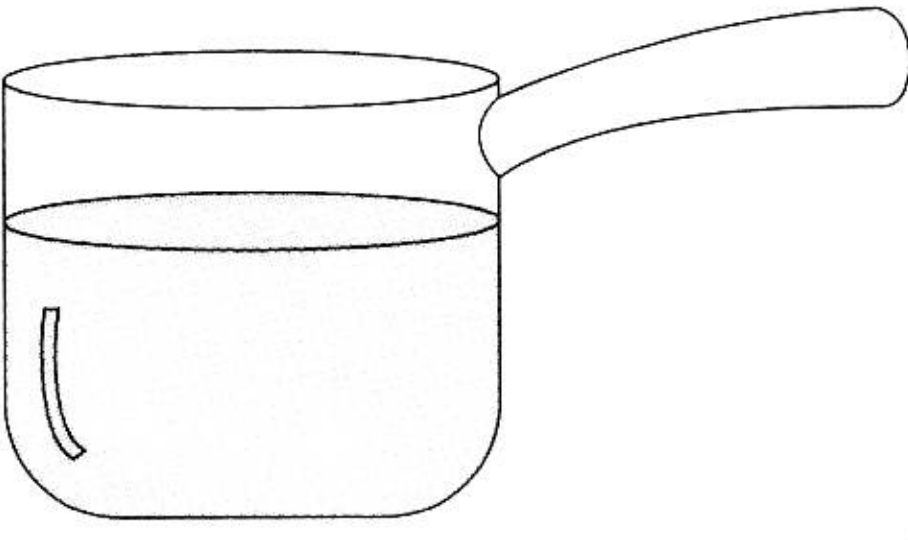
5 น้ำซ้อัด เท่ากับภาพแรก

	 ก	 ข
	 ค	 ง

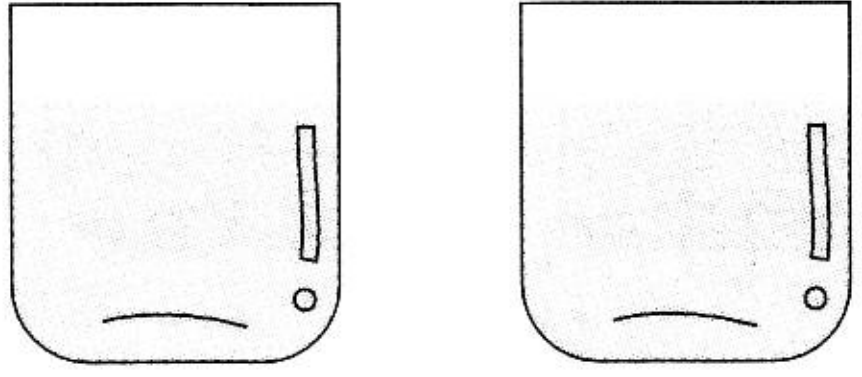
6 นำน้ำในแก้วที่ 2 เทลงในแก้วที่มีขนาดเล็กร่า ระดับน้ำจะเป็นอย่างไร

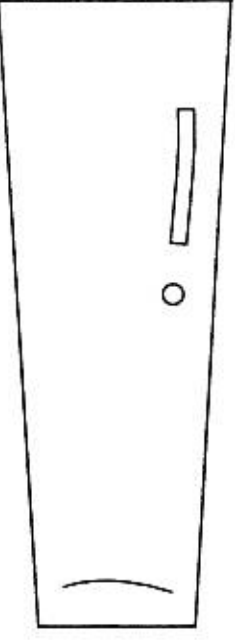
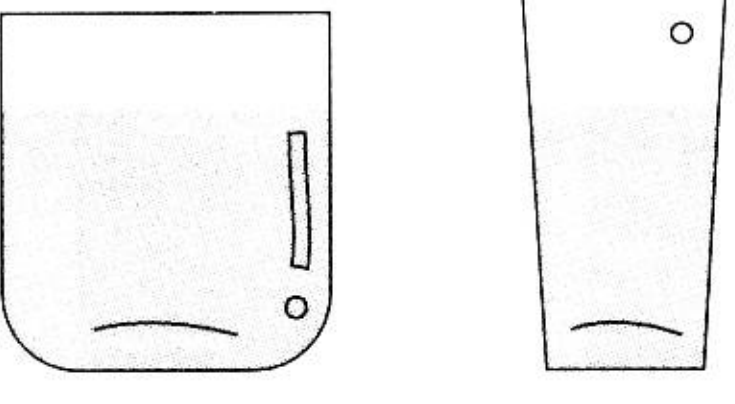
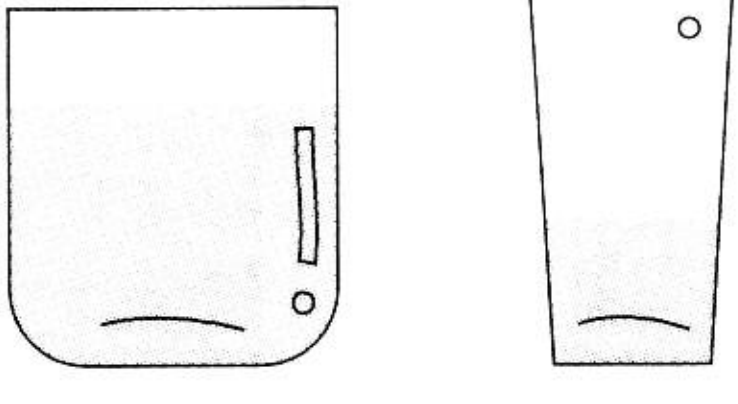
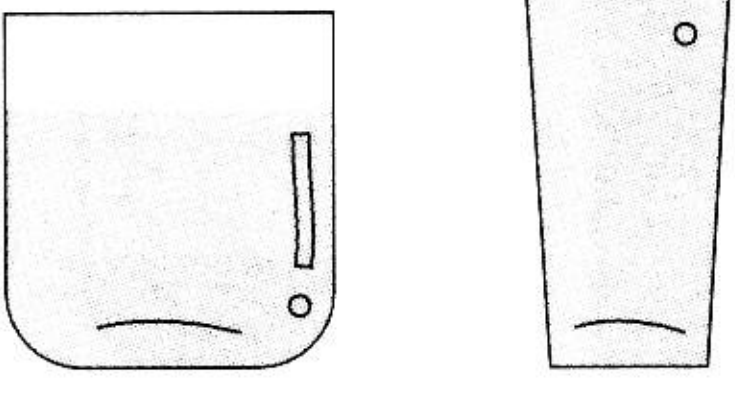
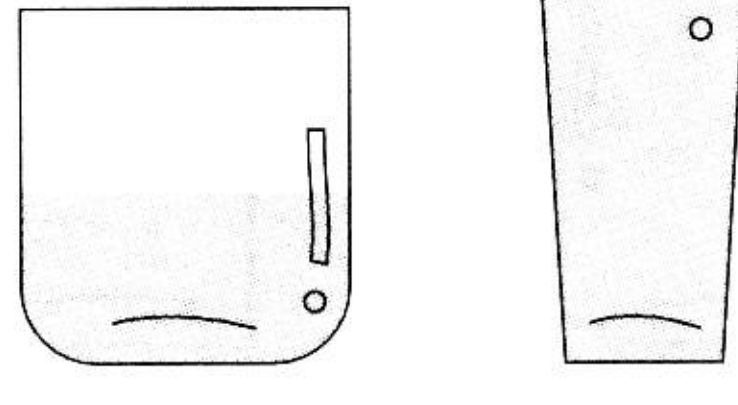
  	 ก	 ข
	 ค	 ง

7 อ่างแก้ว 2 ใบ มีระดับน้ำเท่ากันน้ำเต้า 2 ตัวขนาดเล็กและใหญ่ ใส่ในอ่างแก้วอ่างละ 1 ตัว ระดับน้ำจะเป็นอย่างไร

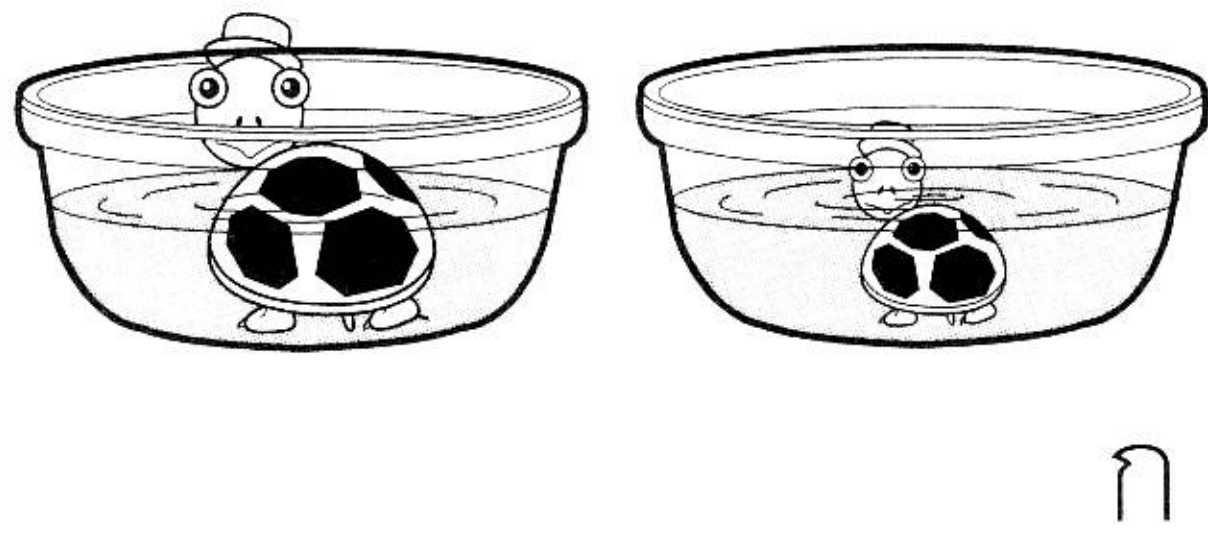
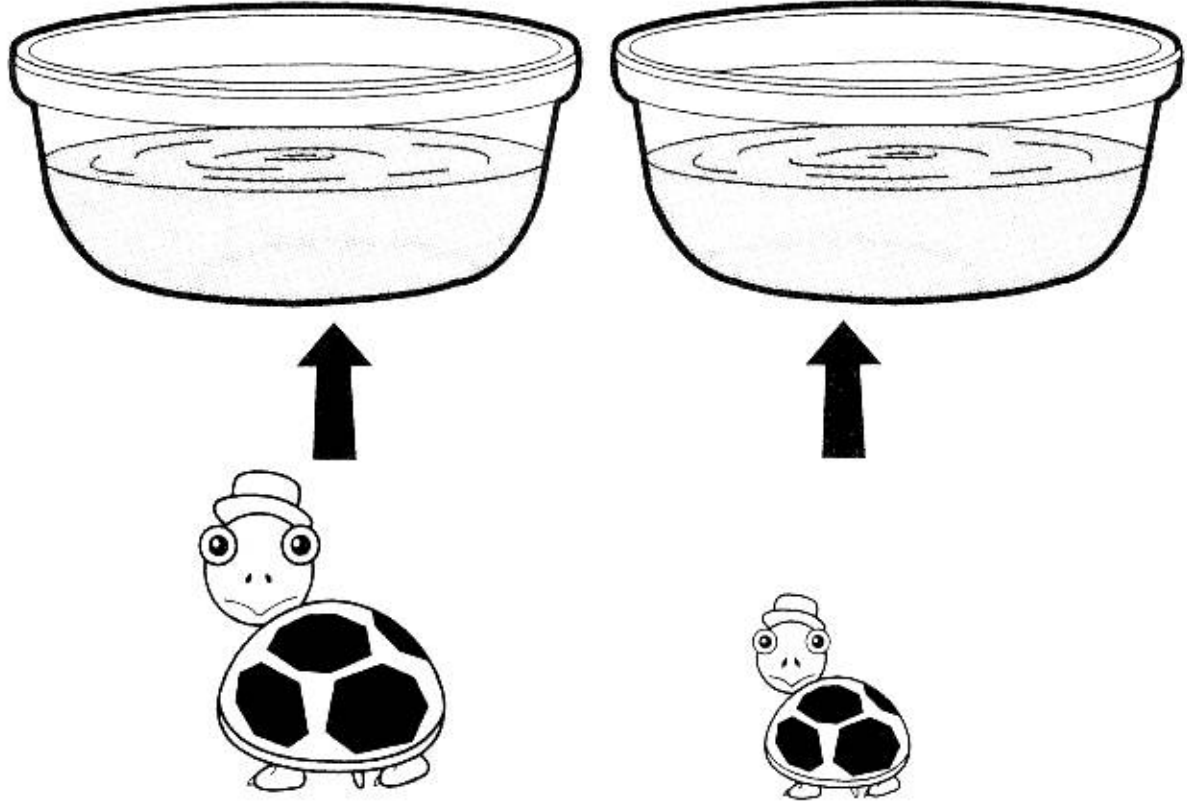

ก

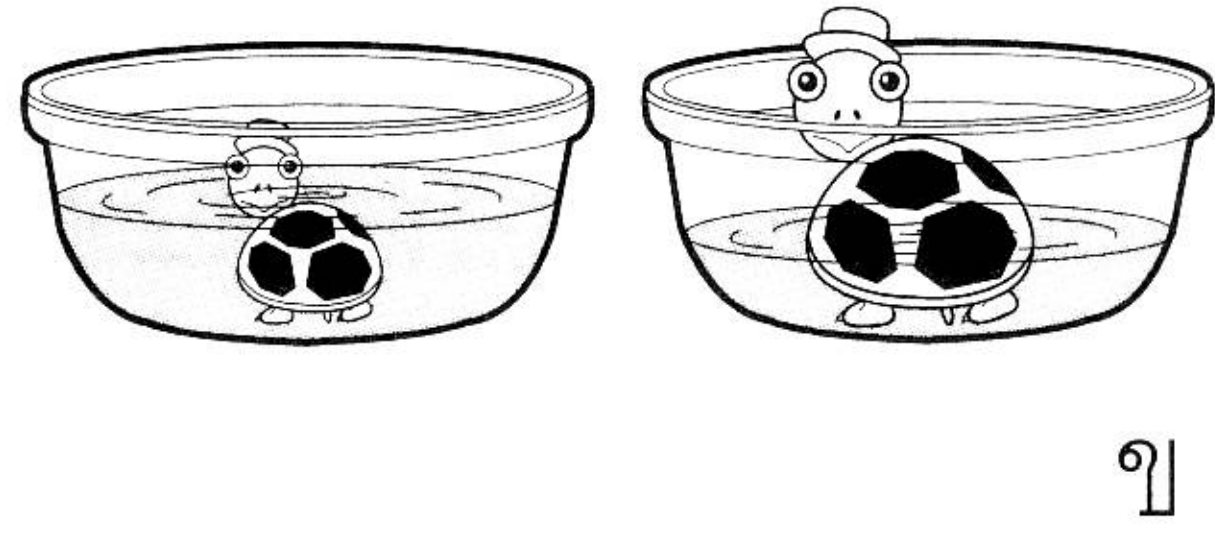

ข

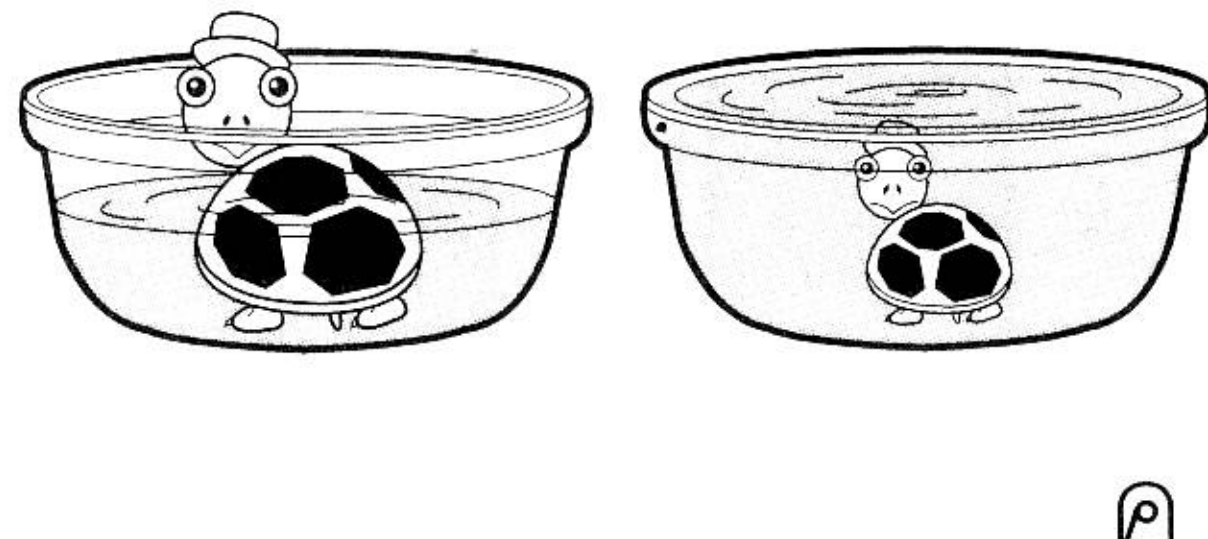

ค

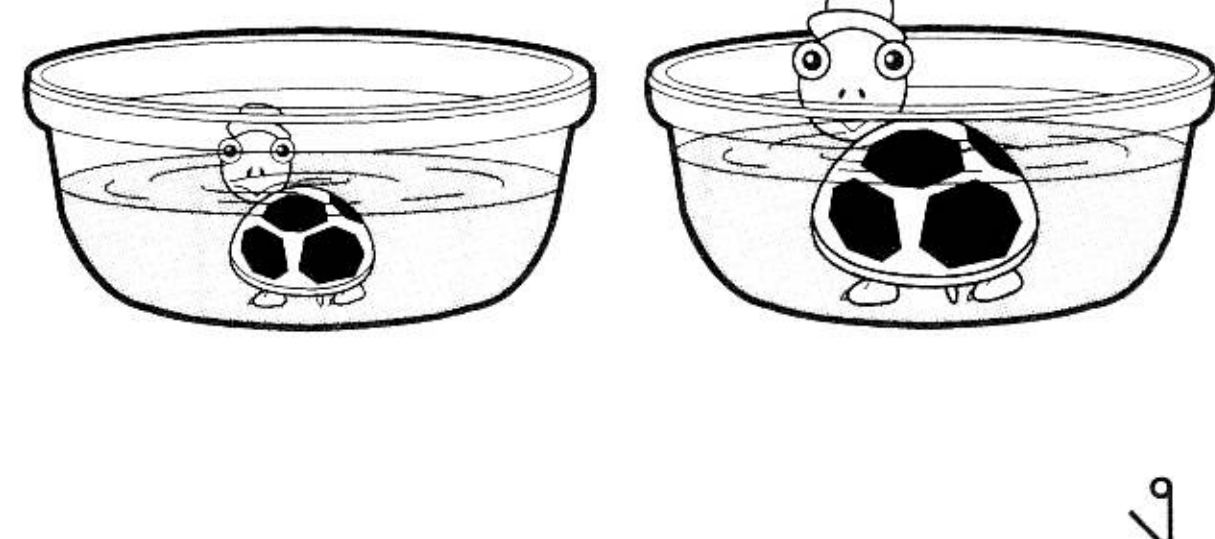

ง

8 อ่างน้ำมีน้ำอยู่ครึ่งอ่าง ถ้าหมูลงไปนอนอาบน้ำในอ่างระดับน้ำจะเป็นอย่างไร

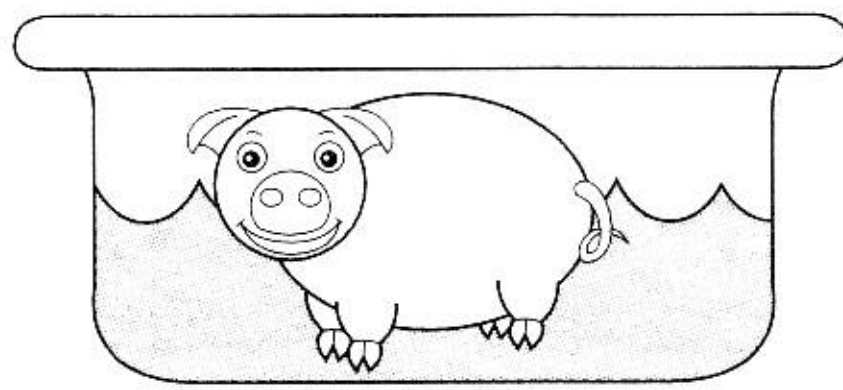
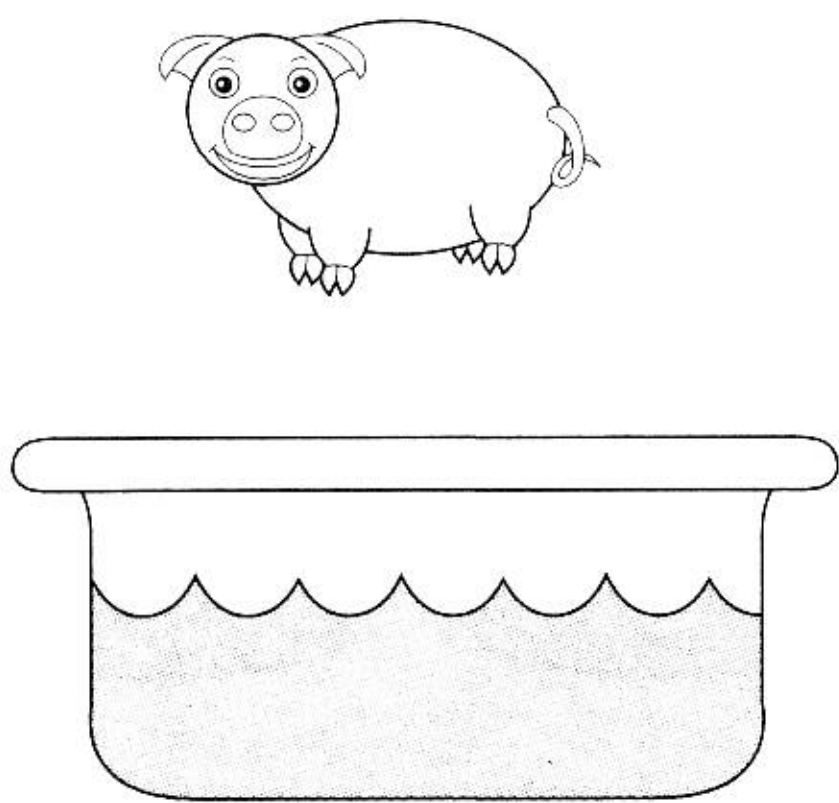

ก

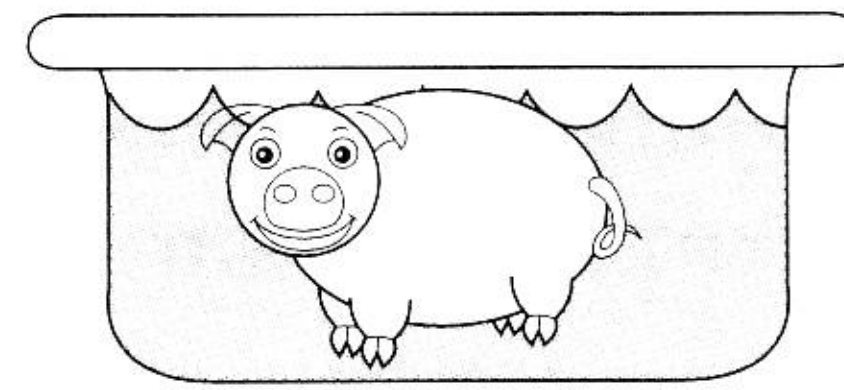

ข

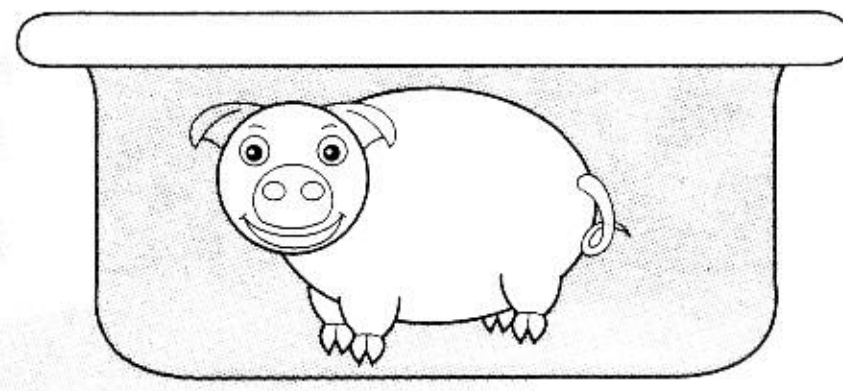

ค

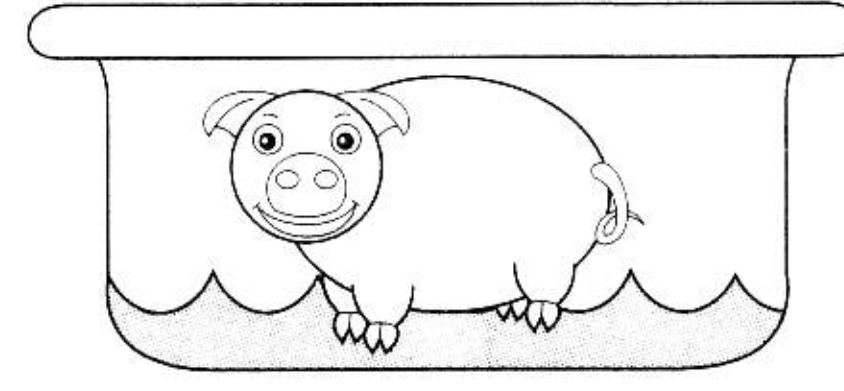

ง

9 ท่าเรือแห่งหนึ่งมีเรือบรรทุกสินค้าจอดอยู่ท่าขนลงสินค้า ใส่เรือจนเต็มลำ ระดับน้ำจะเป็นอย่างไร

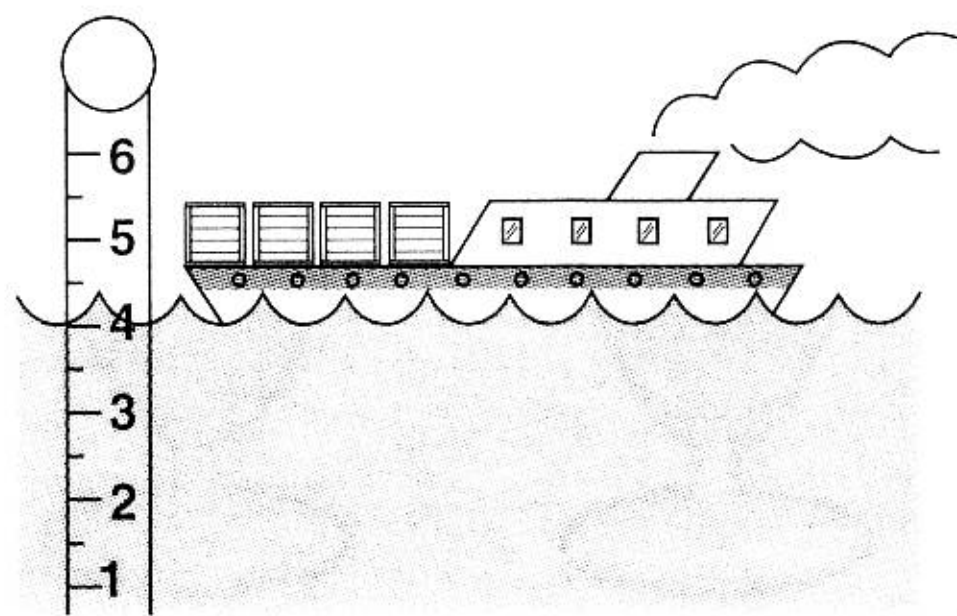
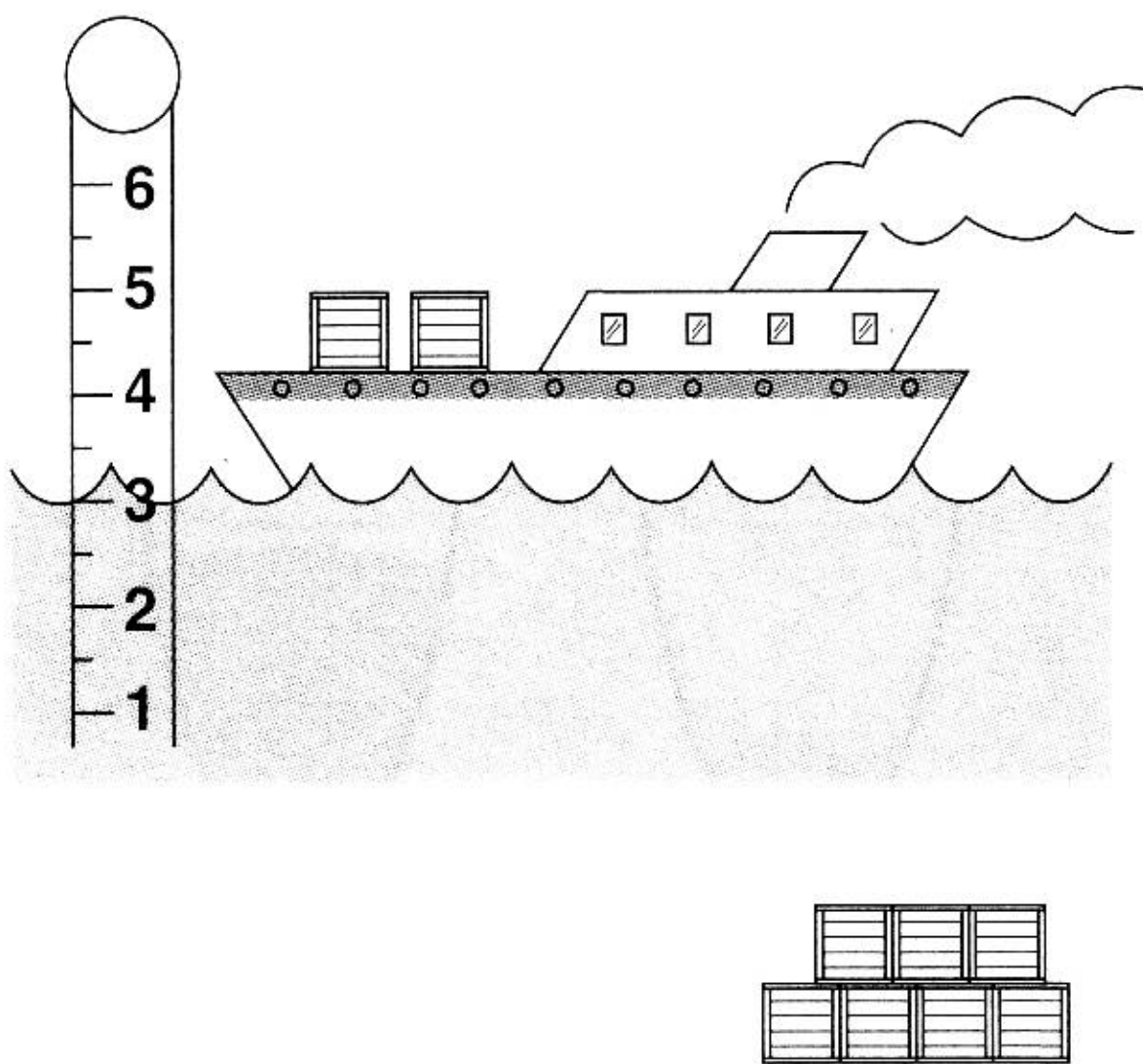

ก

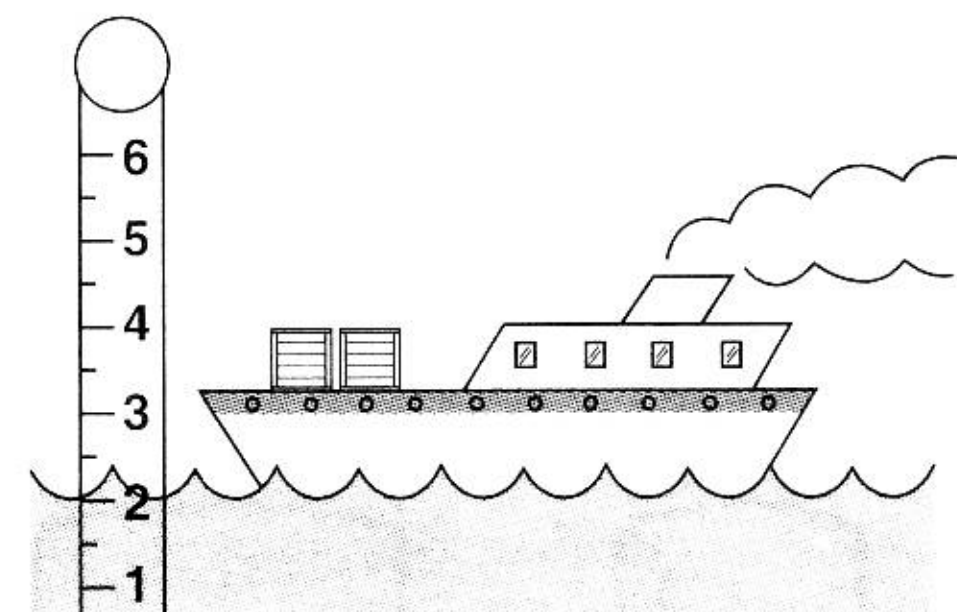

ข

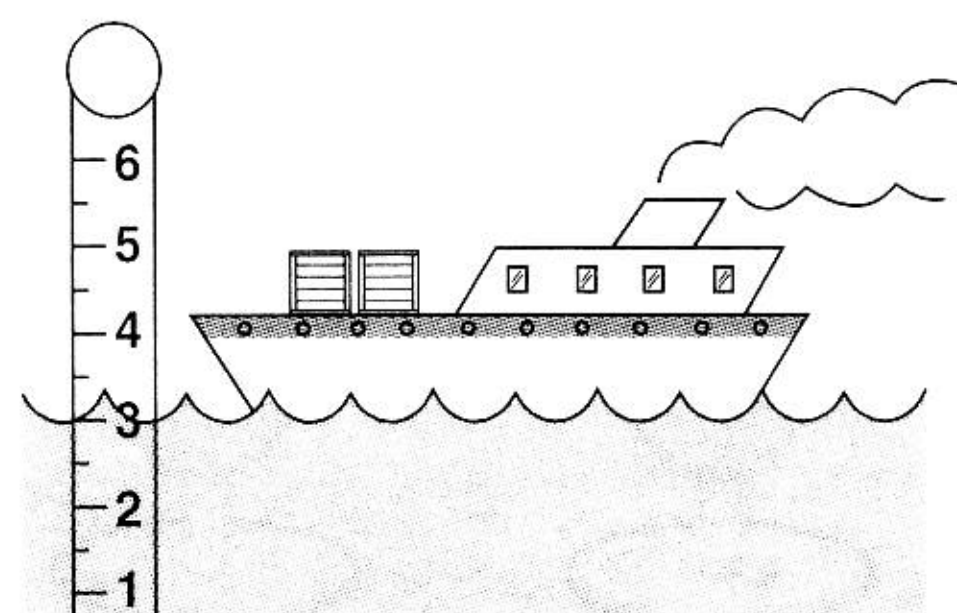

ค

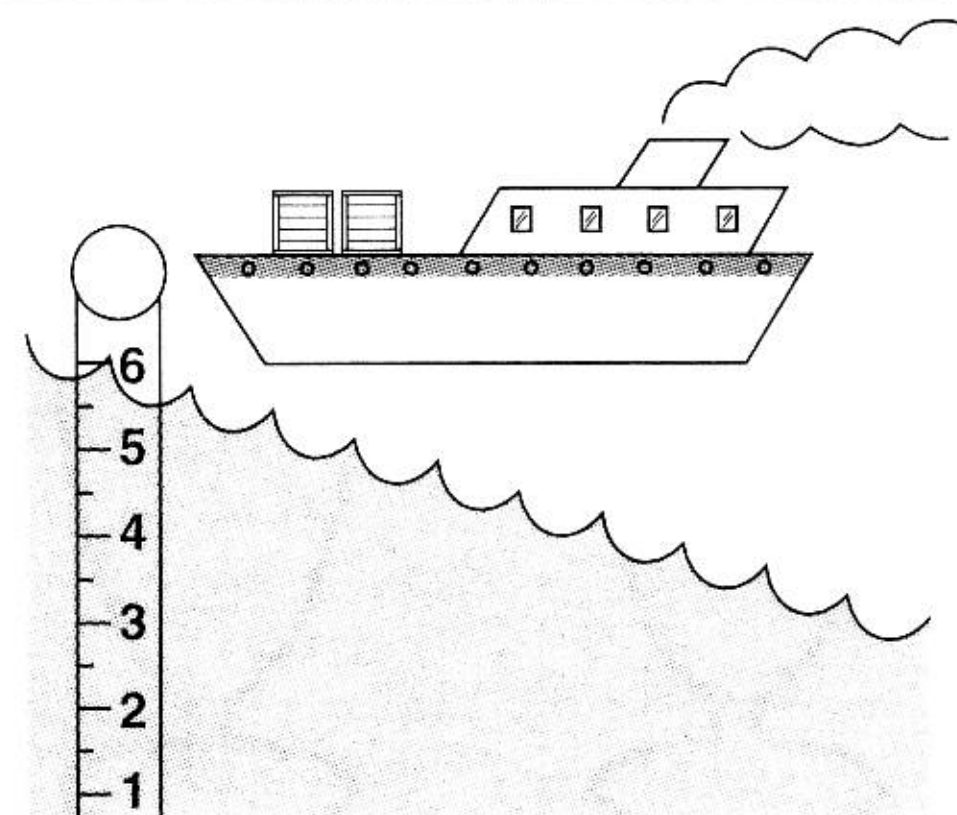

ง

10 นำน้ำในขัน 2 ใบ ซึ่งมีปริมาณเท่ากันใส่ในแก้ว 2 ใบที่มีขนาดเท่ากันแต่ต่างกันตรงกัน คือใบหนึ่งก้นลึกกว่า ระดับน้ำในแก้วจะเป็นอย่างไร

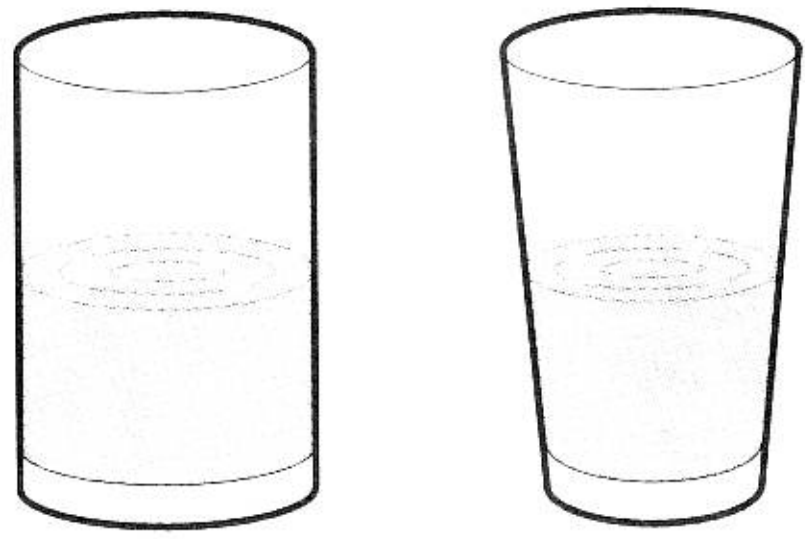
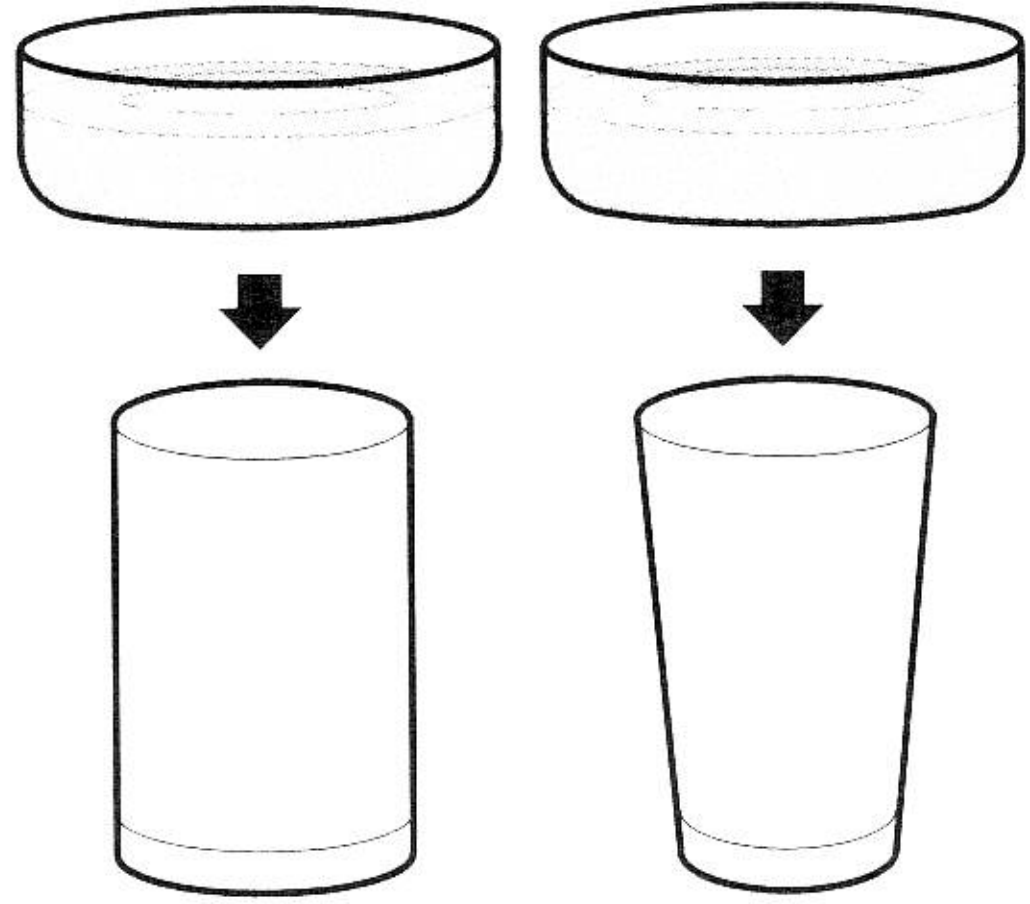

ก

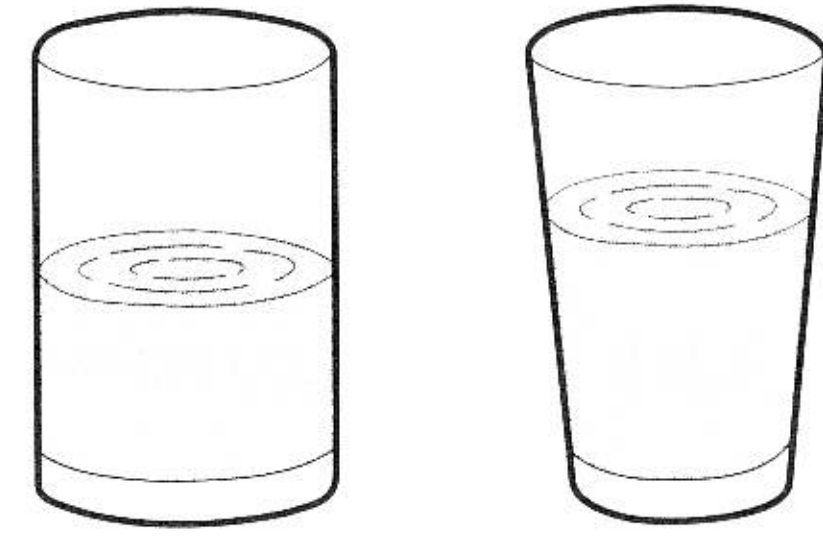

ข

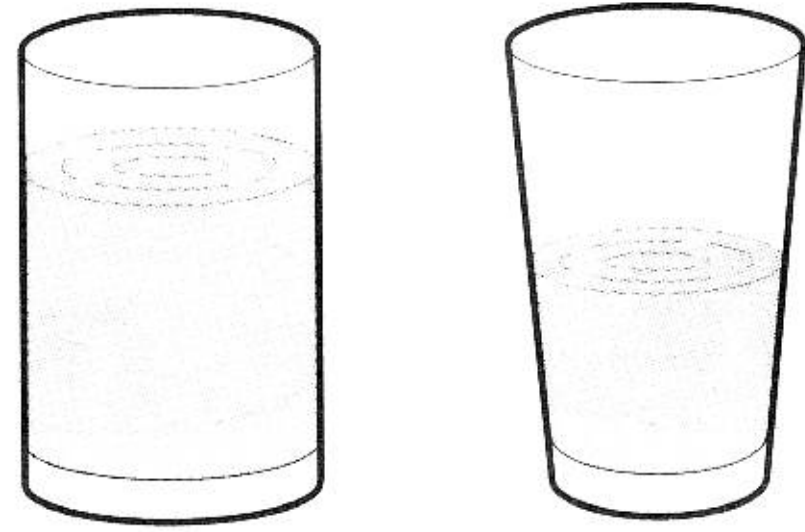

ค

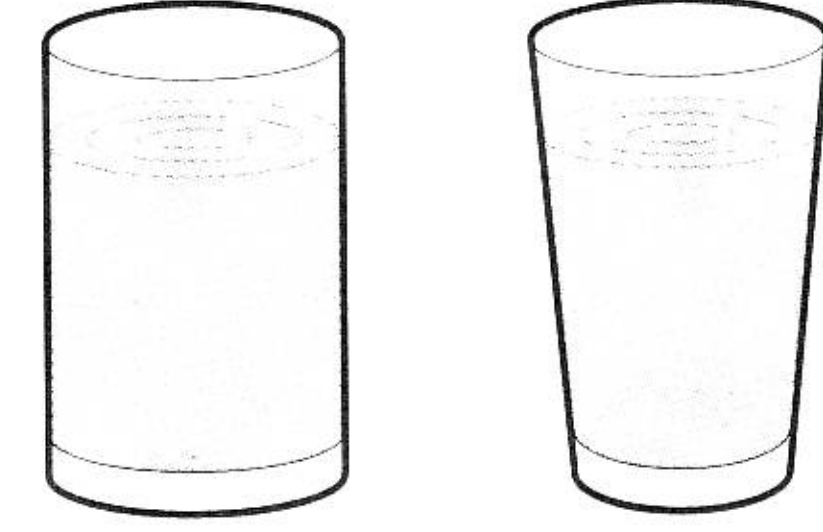

ง

11 อ่างอาบน้ำมีน้ำอยู่ครึ่งอ่าง ถ้าเจ้าตูบจอมขน 2 ตัวนี้ ลงไปนอนอาบน้ำในอ่าง ระดับน้ำจะเป็นอย่างไร

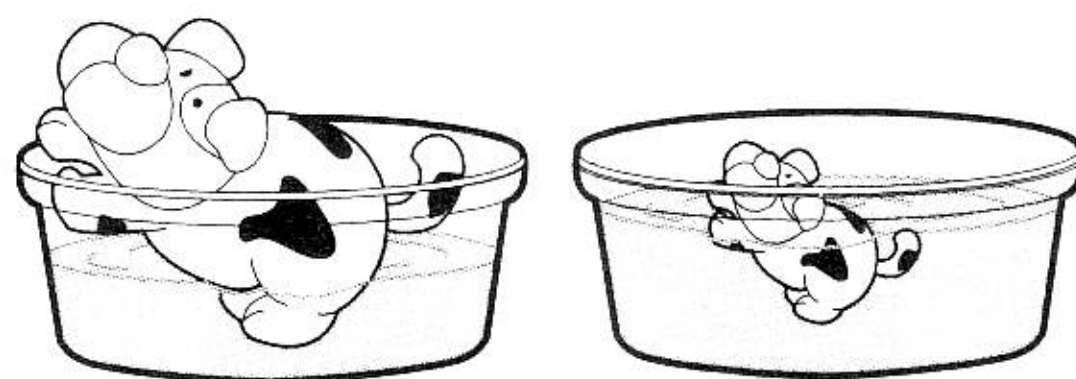
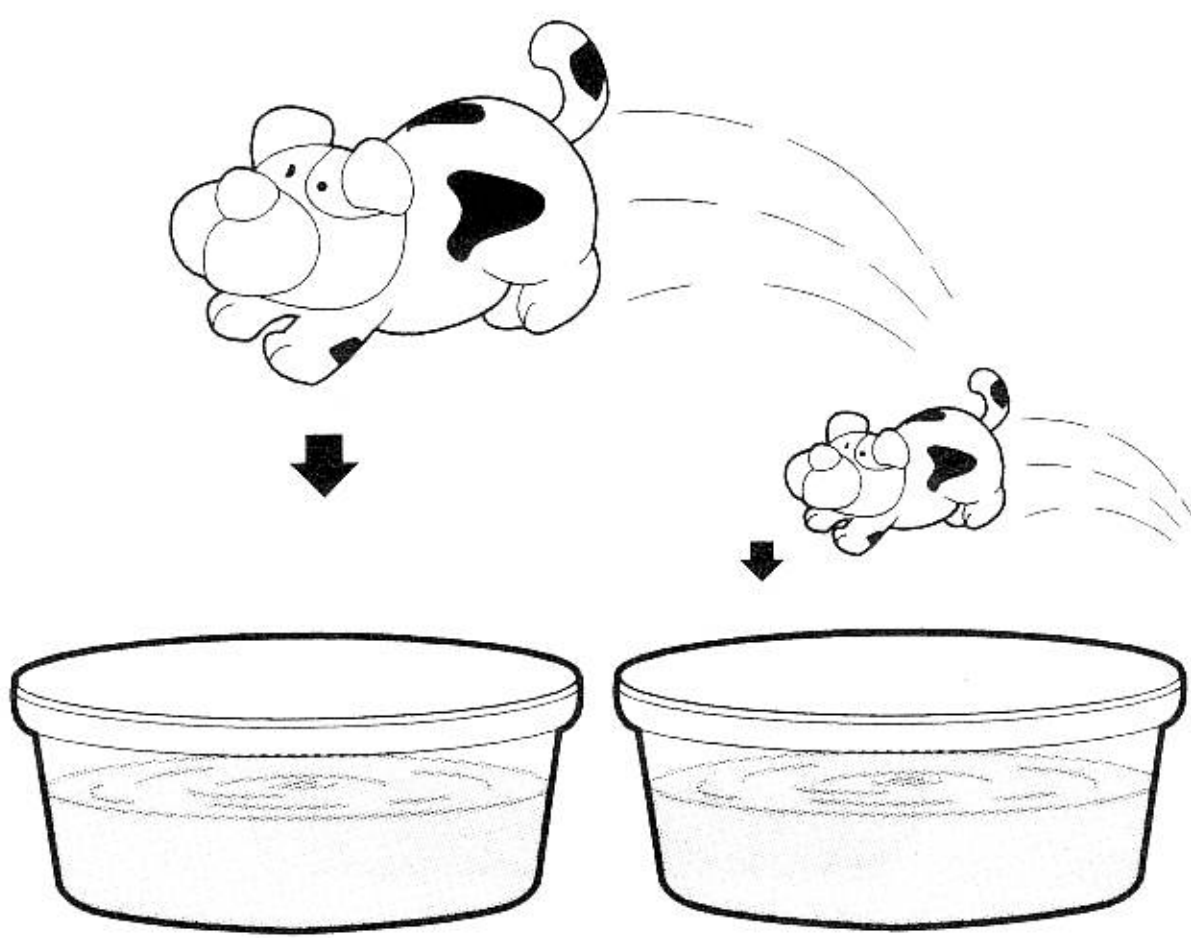

ก

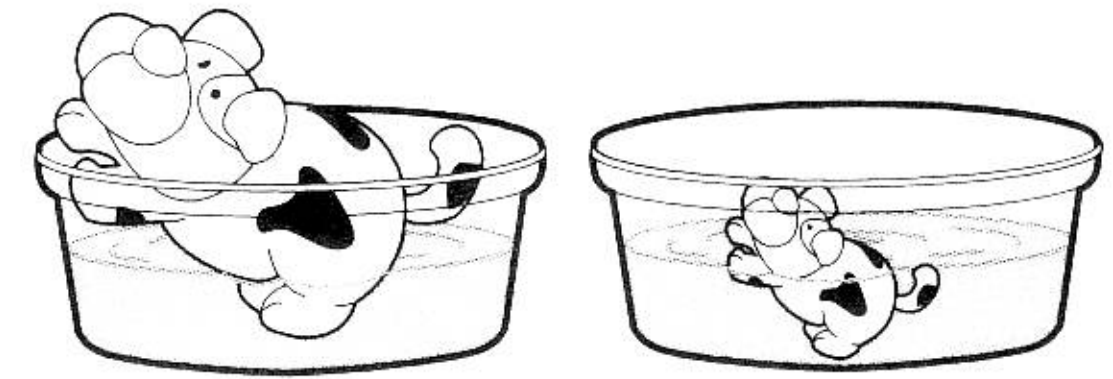

ข

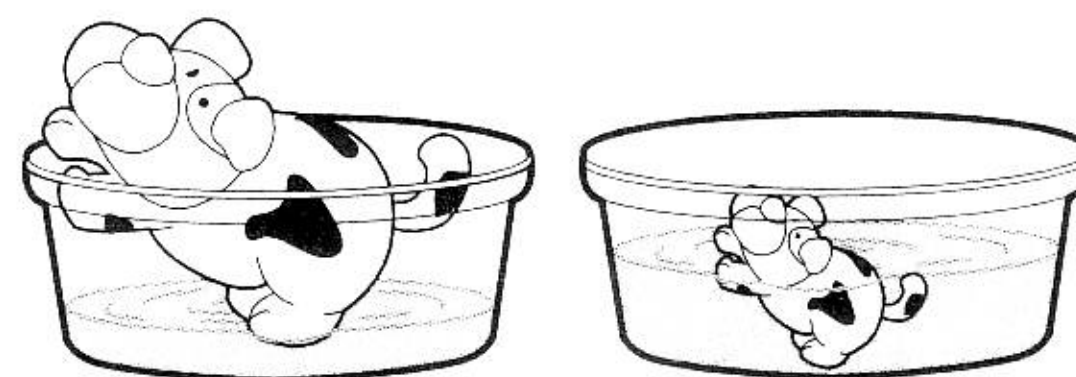

ค

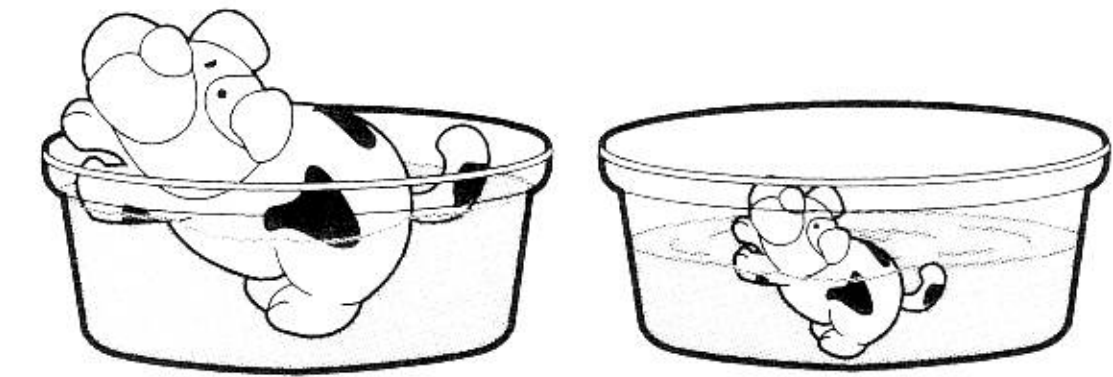

ง

12 นำน้ำในแก้ว 2 ใบที่มีขนาดต่างกันแต่มีปริมาณน้ำเท่ากันมาใส่ในแก้วที่มีขนาดและแบบเดียวกัน จะเป็นอย่างไร

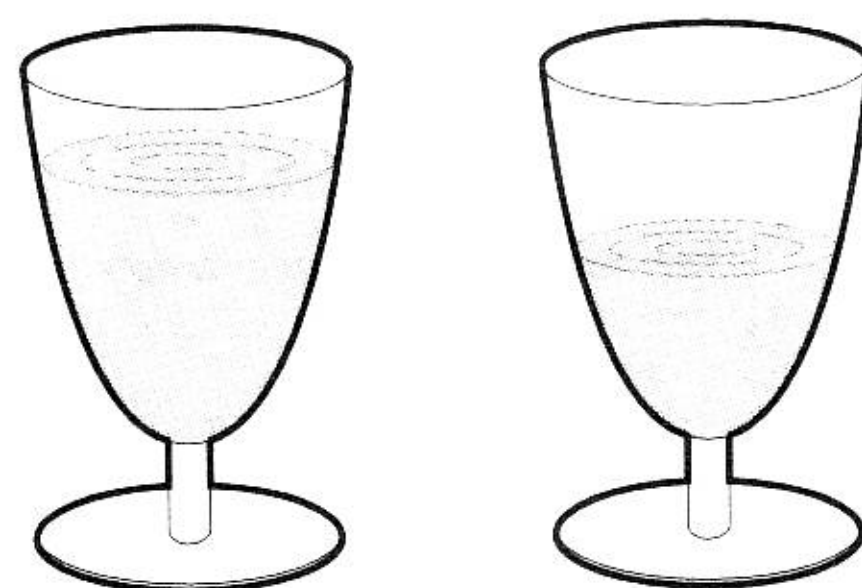
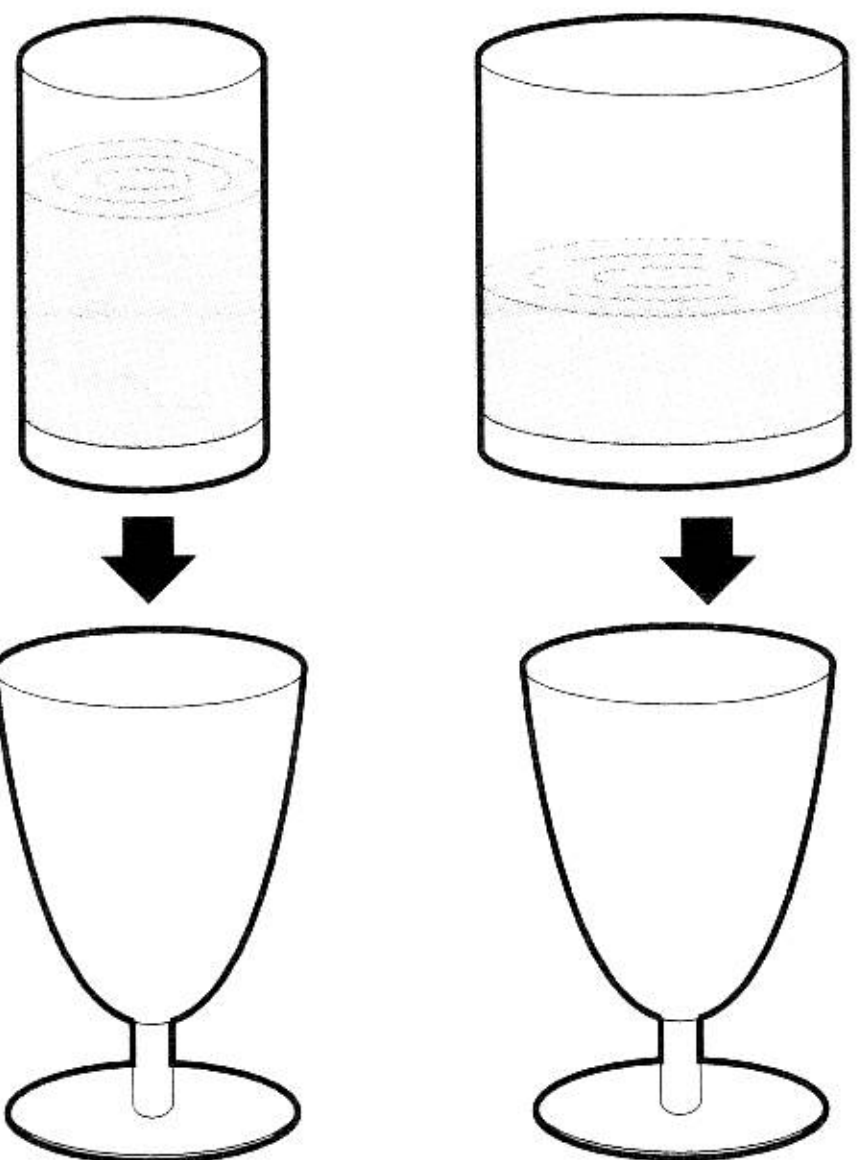

ก

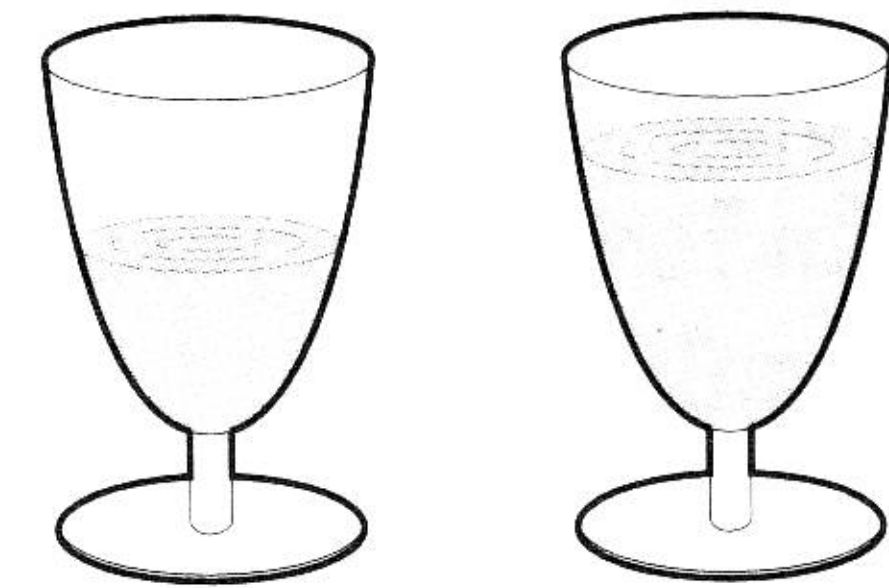

ข

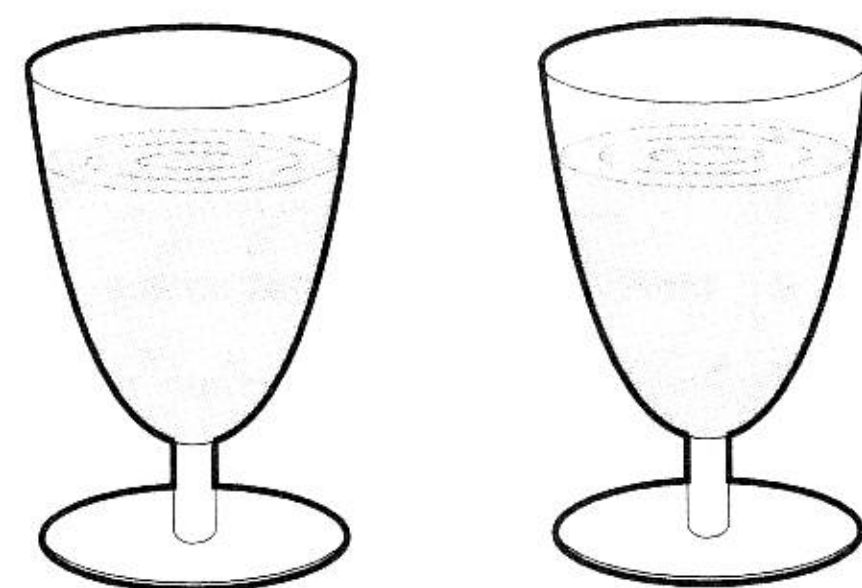

ค

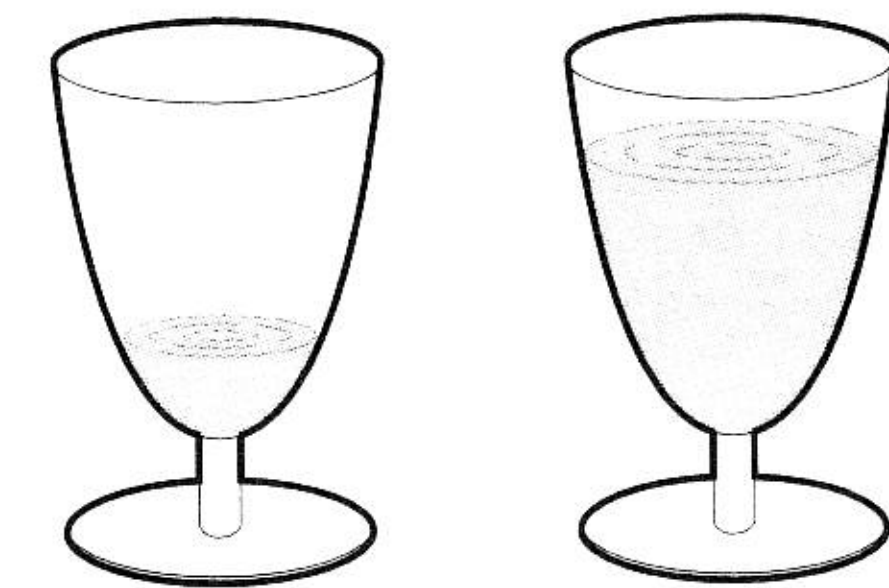

ง

13

ถ้าเอาน้ำจากขวดเทลงใน  
หลอดแก้วรูปตัว U ระดับ  
น้ำจะเป็นอย่างไร

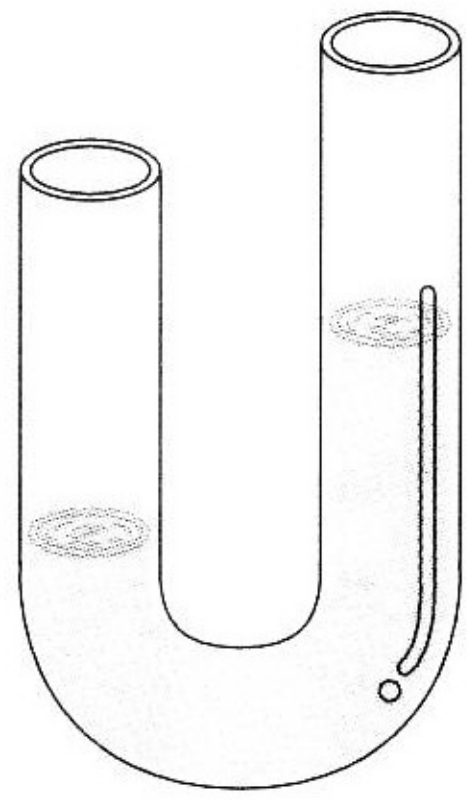
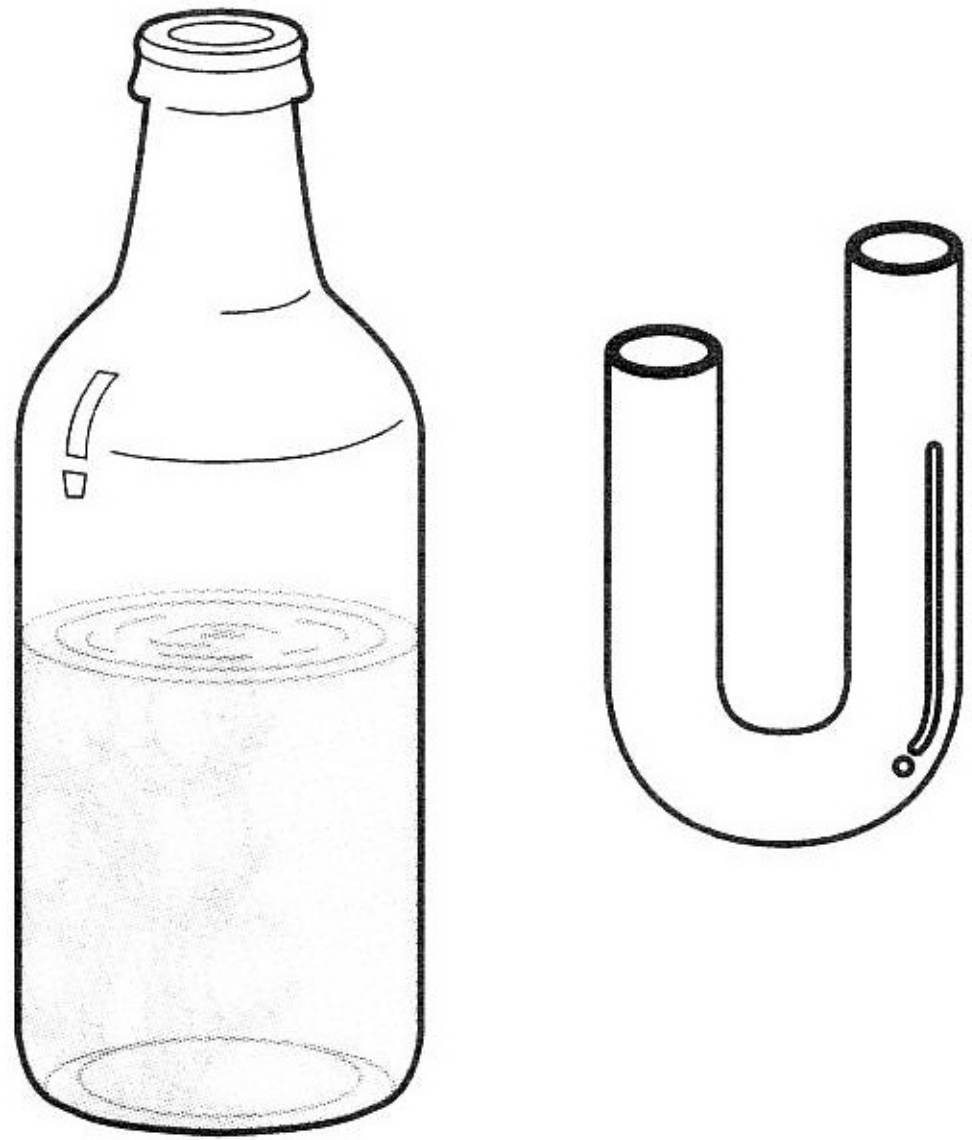

ก

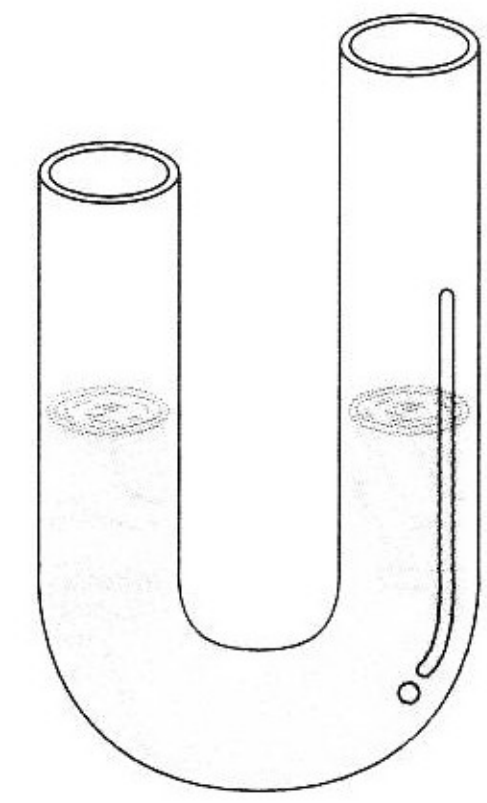

ข

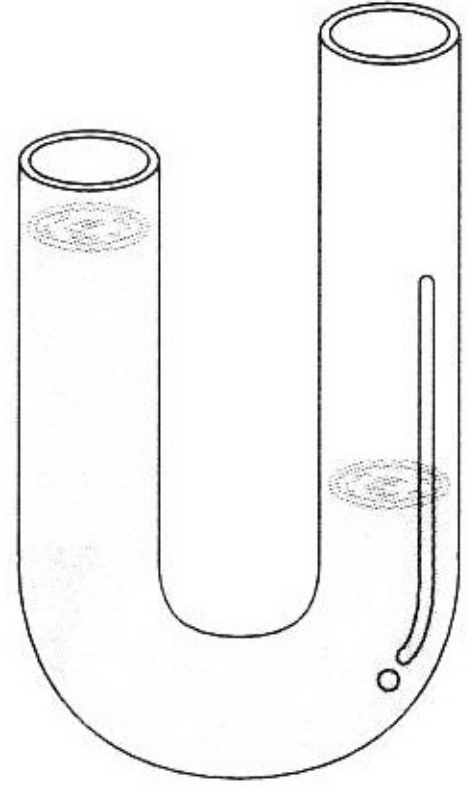

ค

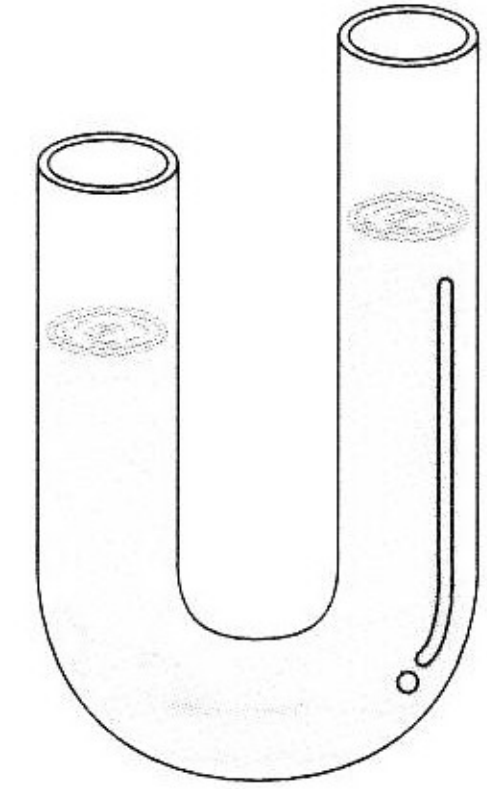

ง

14

ถ้าเอาน้ำใส่กระป๋องที่  
เจาะรูไว้เรียงจากบนลงล่าง  
ขนาดรูเท่า ๆ น้ำที่ไหลออก  
จากรูจะมีลักษณะอย่างไร

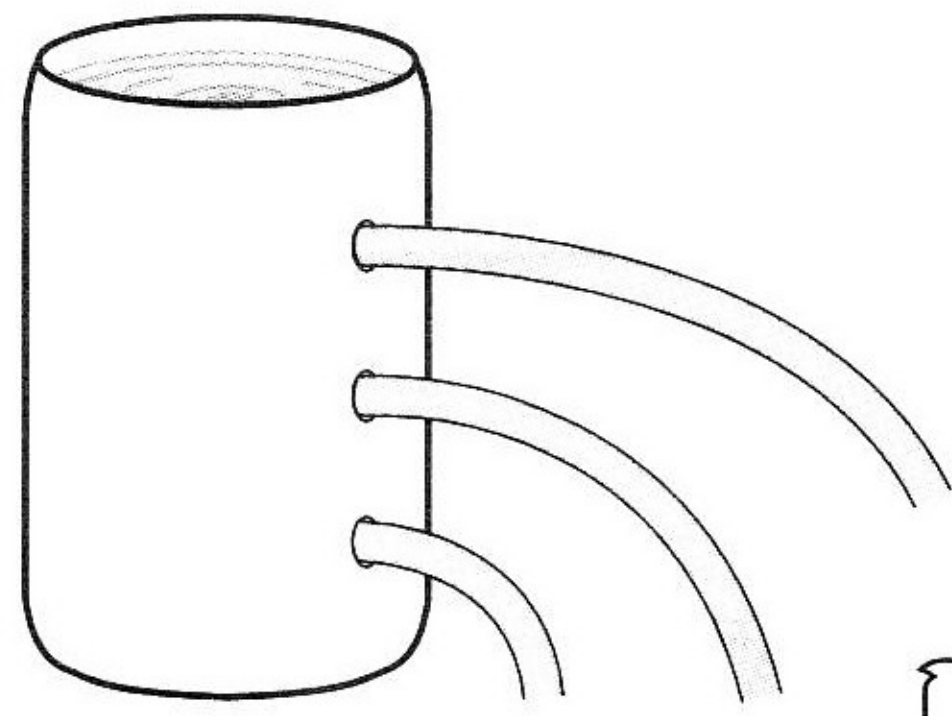
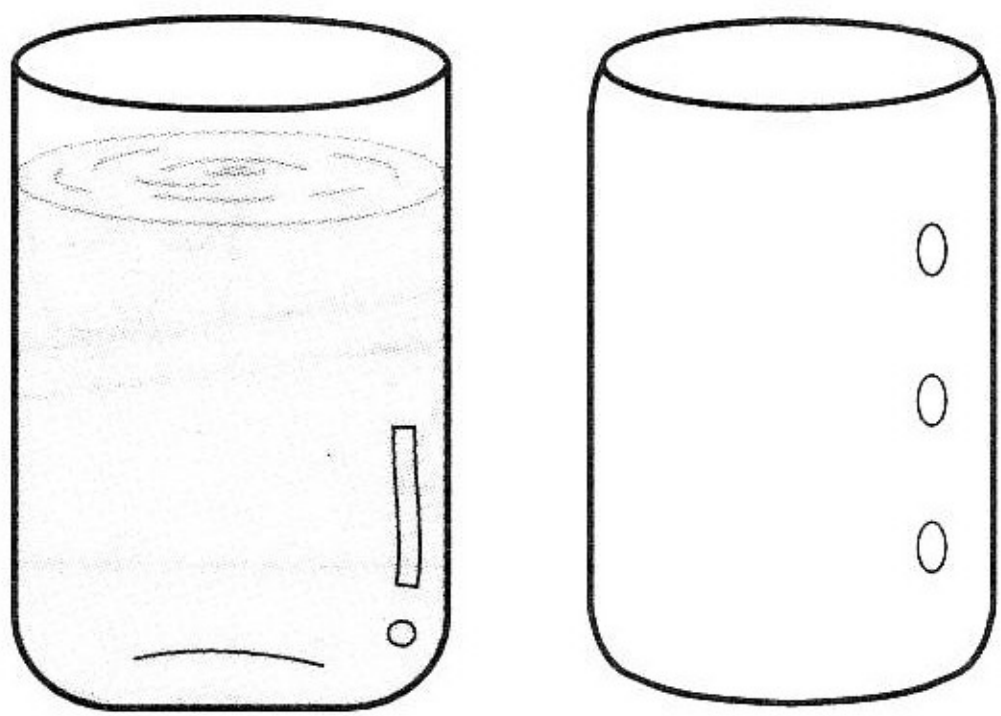

ก

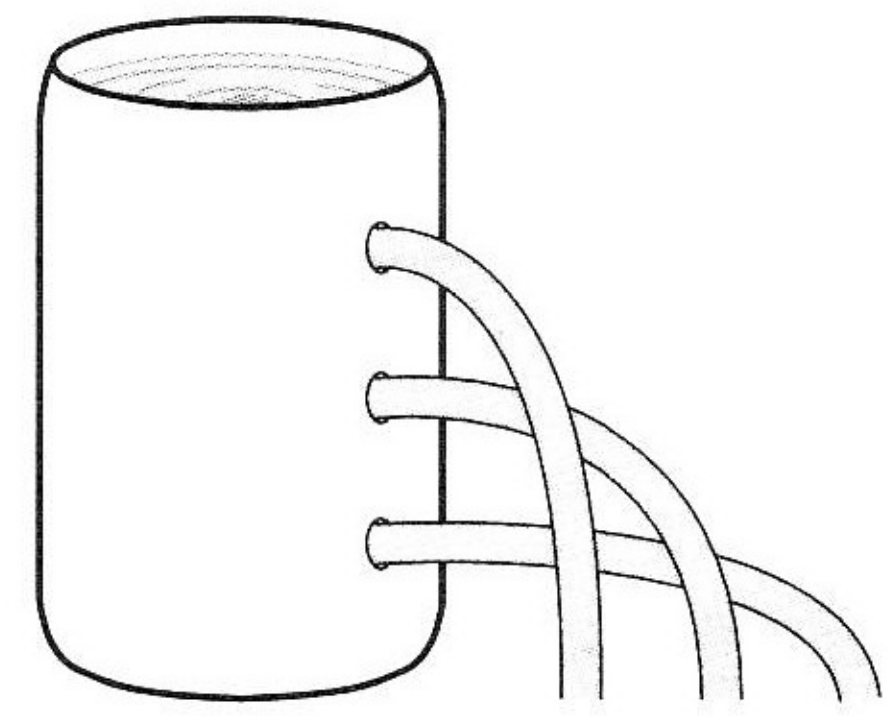

ข

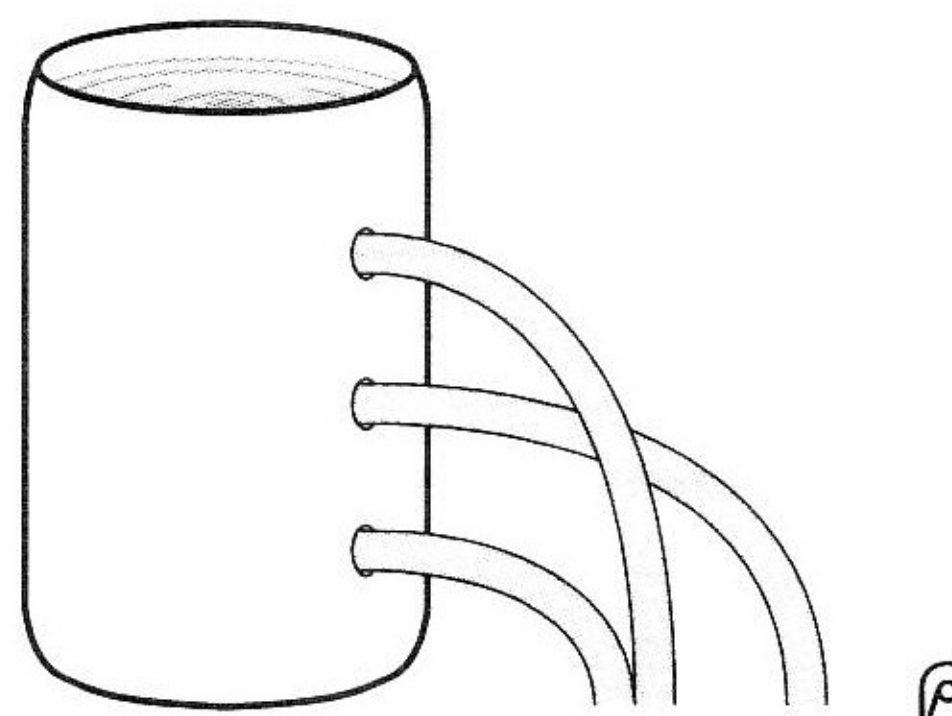

ค

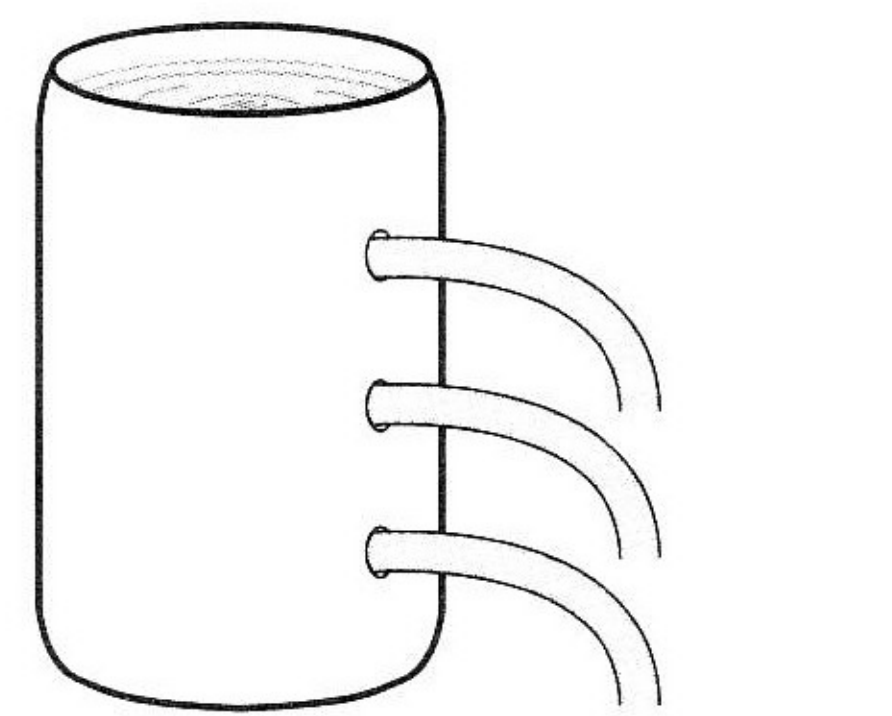

ง

15

ถ้าต้องการจะถ่ายน้ำจากถัง  
ลงใส่ขวดใหญ่โดยใช้สายยาง  
ต้องวางถังและขวดในลักษณะ  
ใดจึงถ่ายได้สะดวกที่สุด

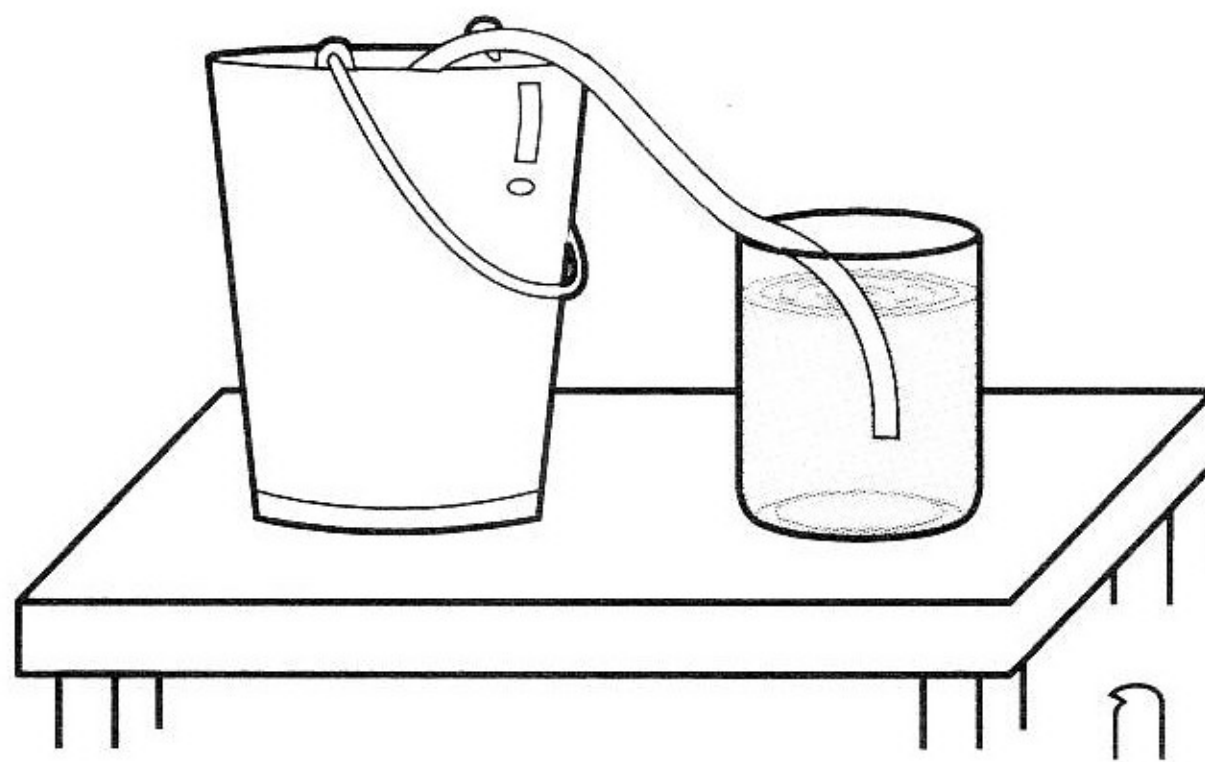
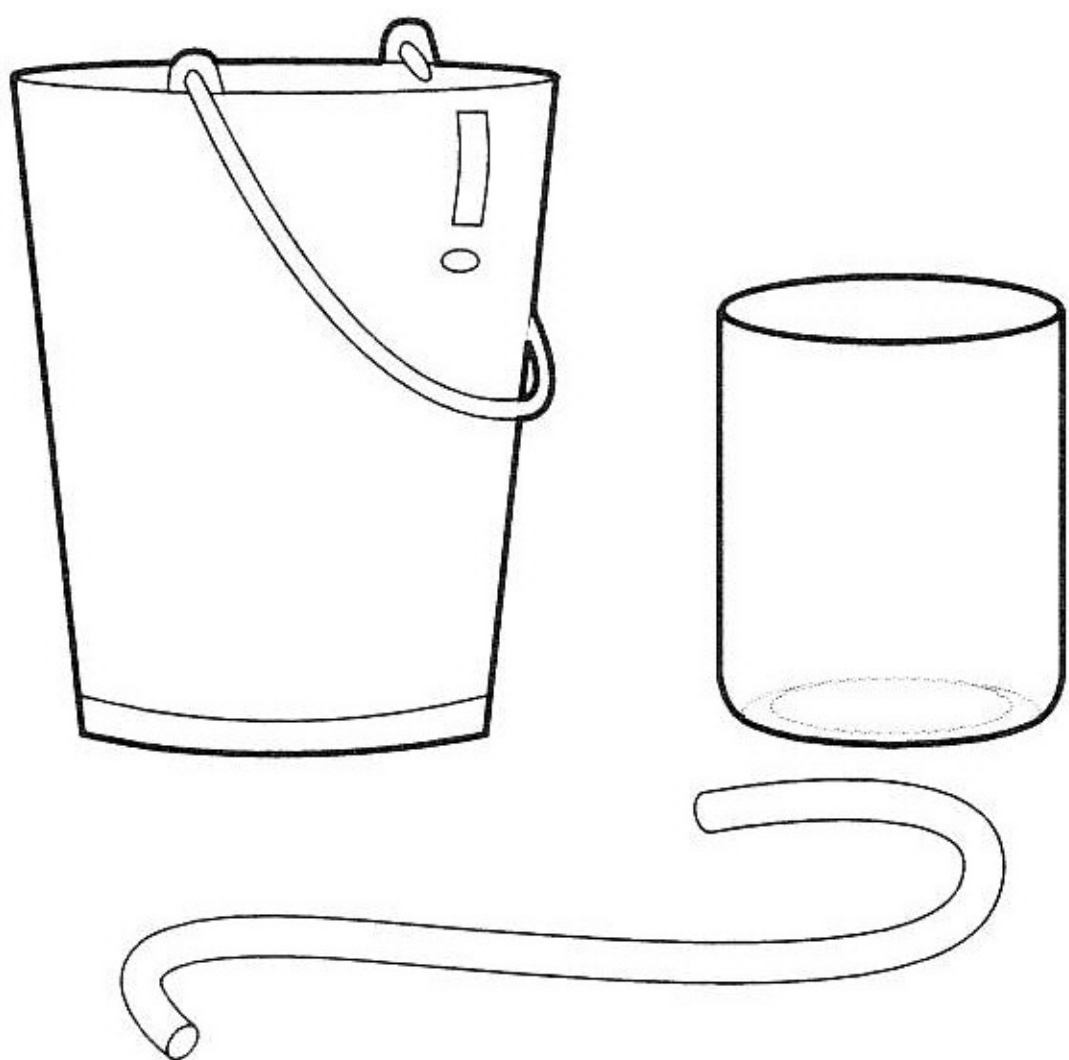

ก

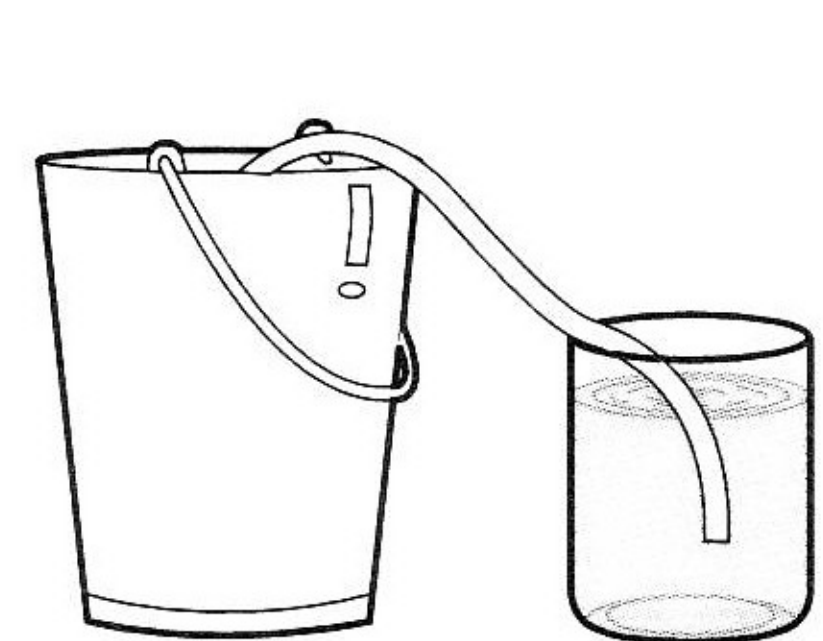

ข

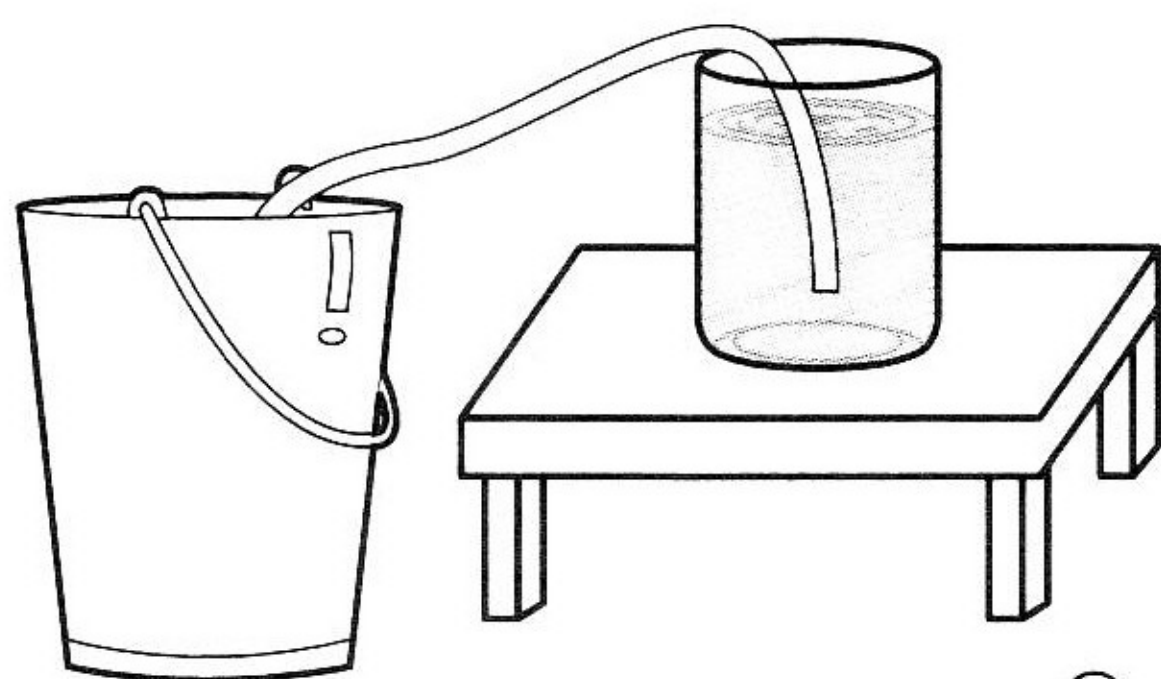

ค

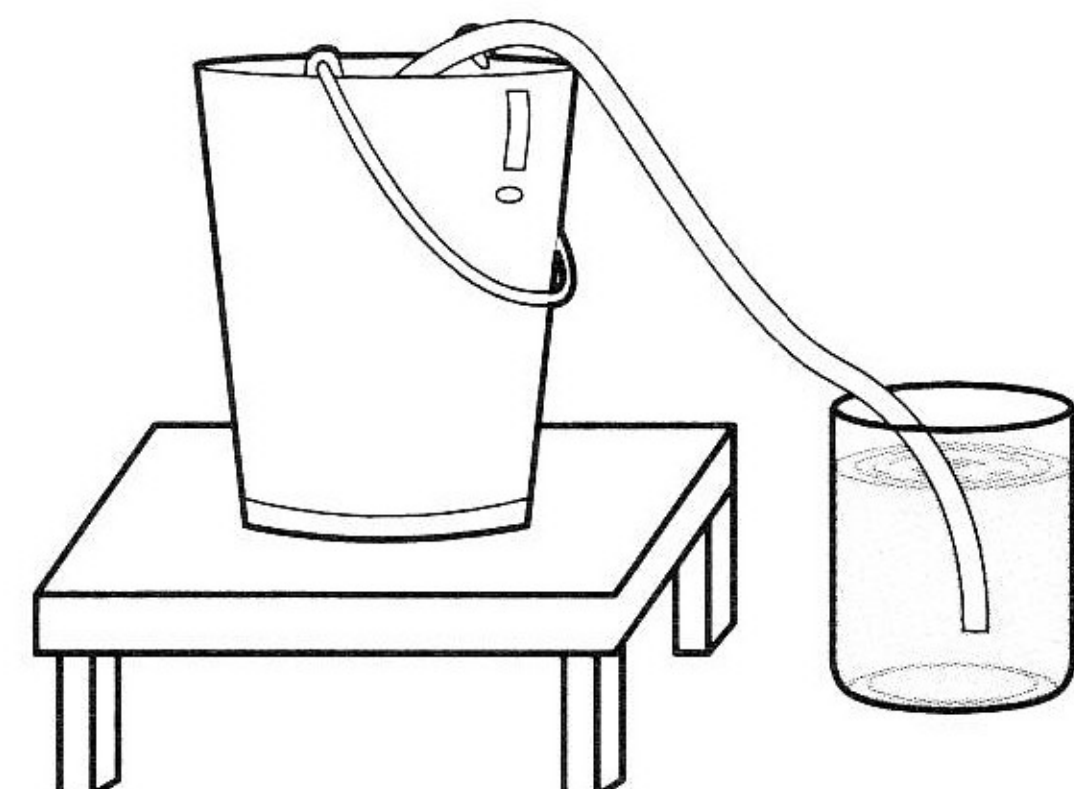

ง

จงขีด ✓ ข้อที่มีน้ำหนักสัมพันธ์กับภาพในช่องแรก

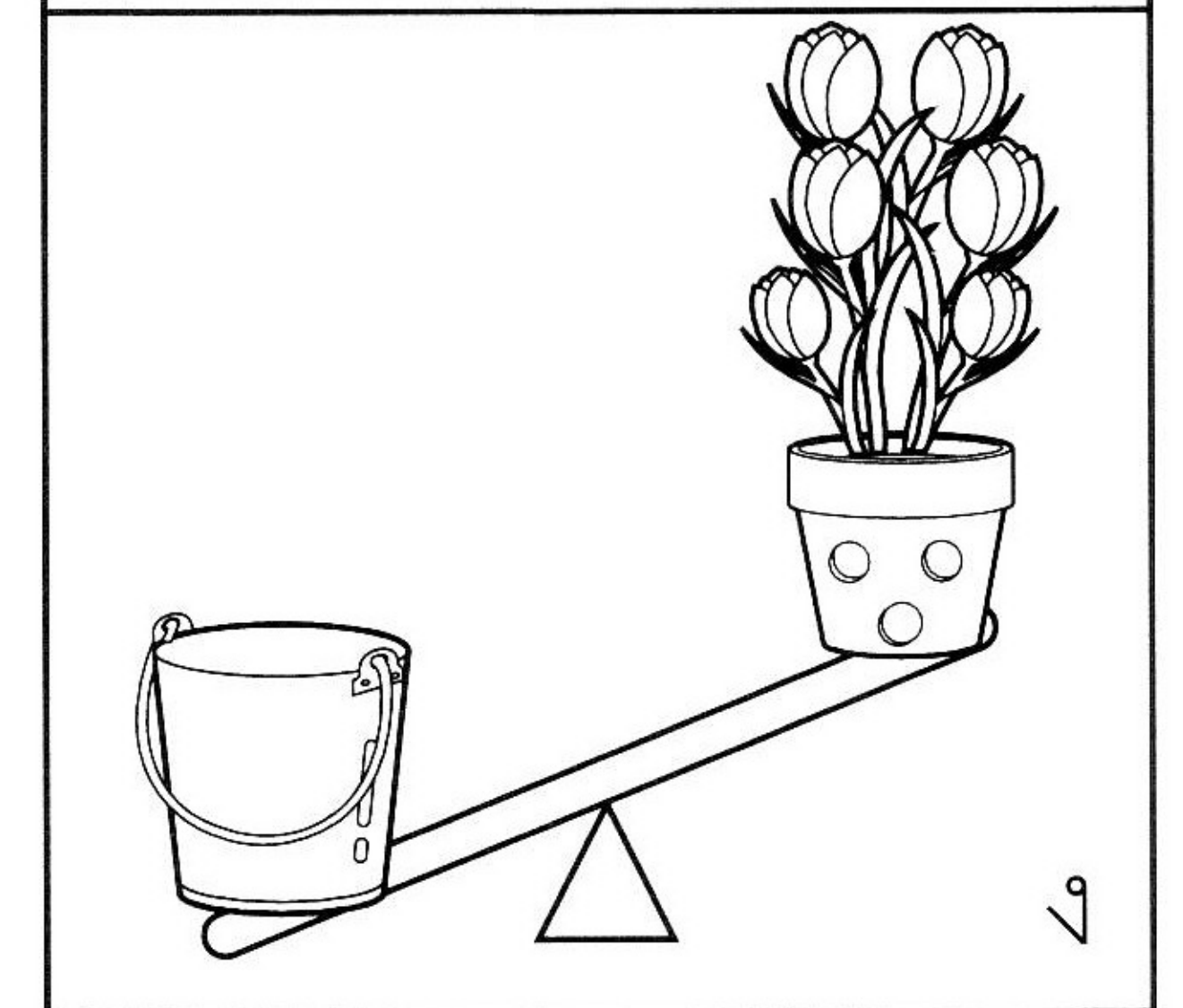
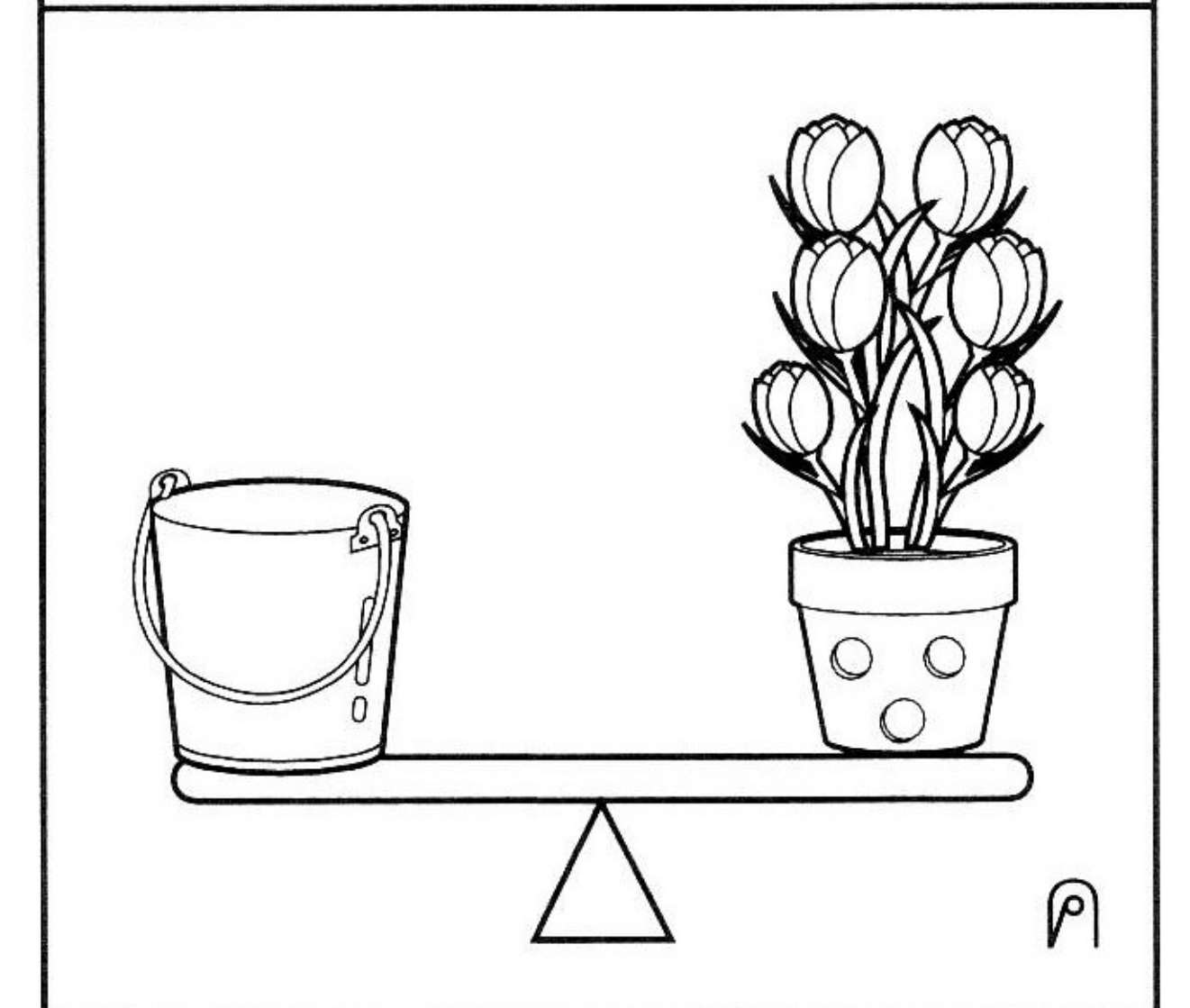
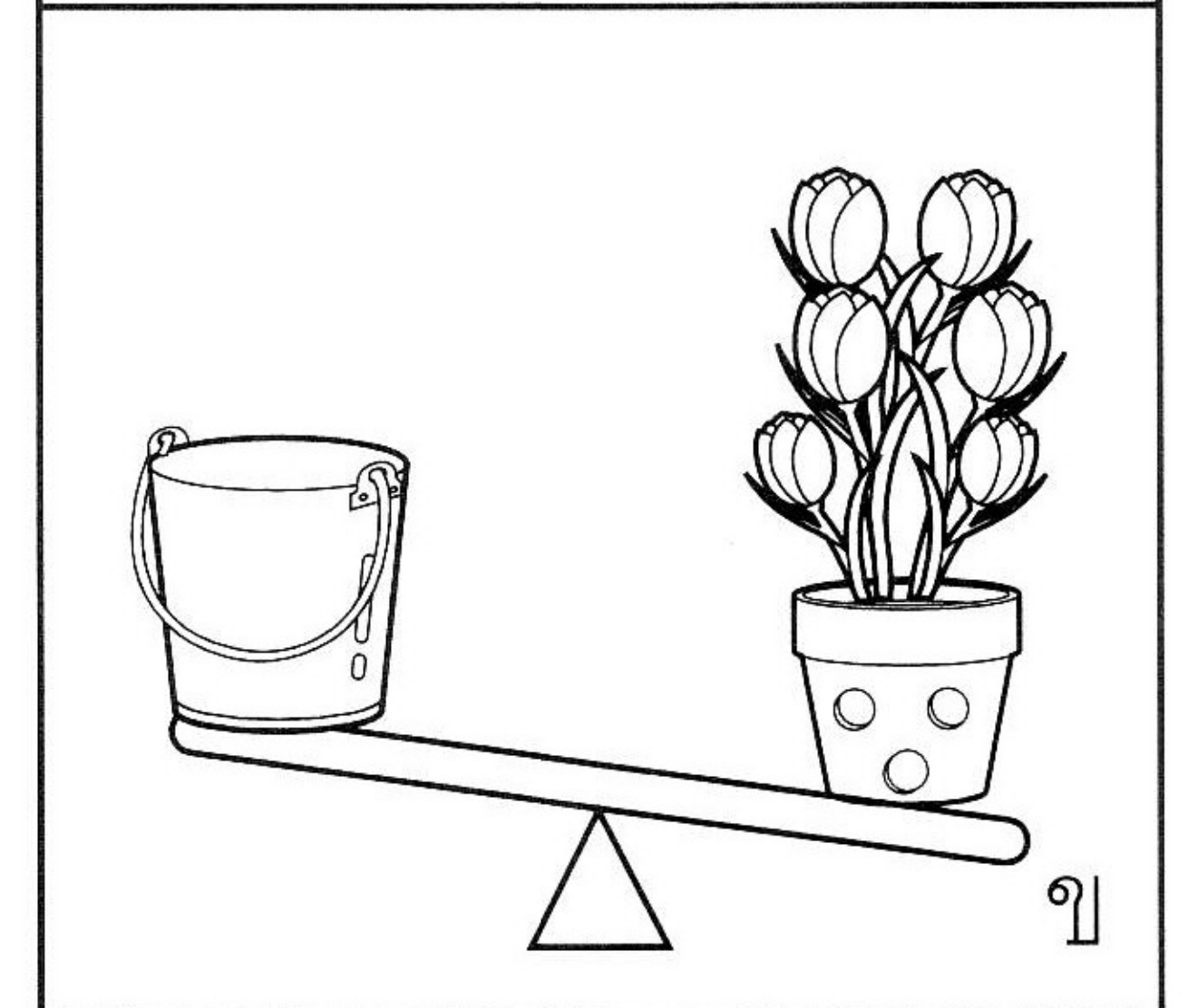
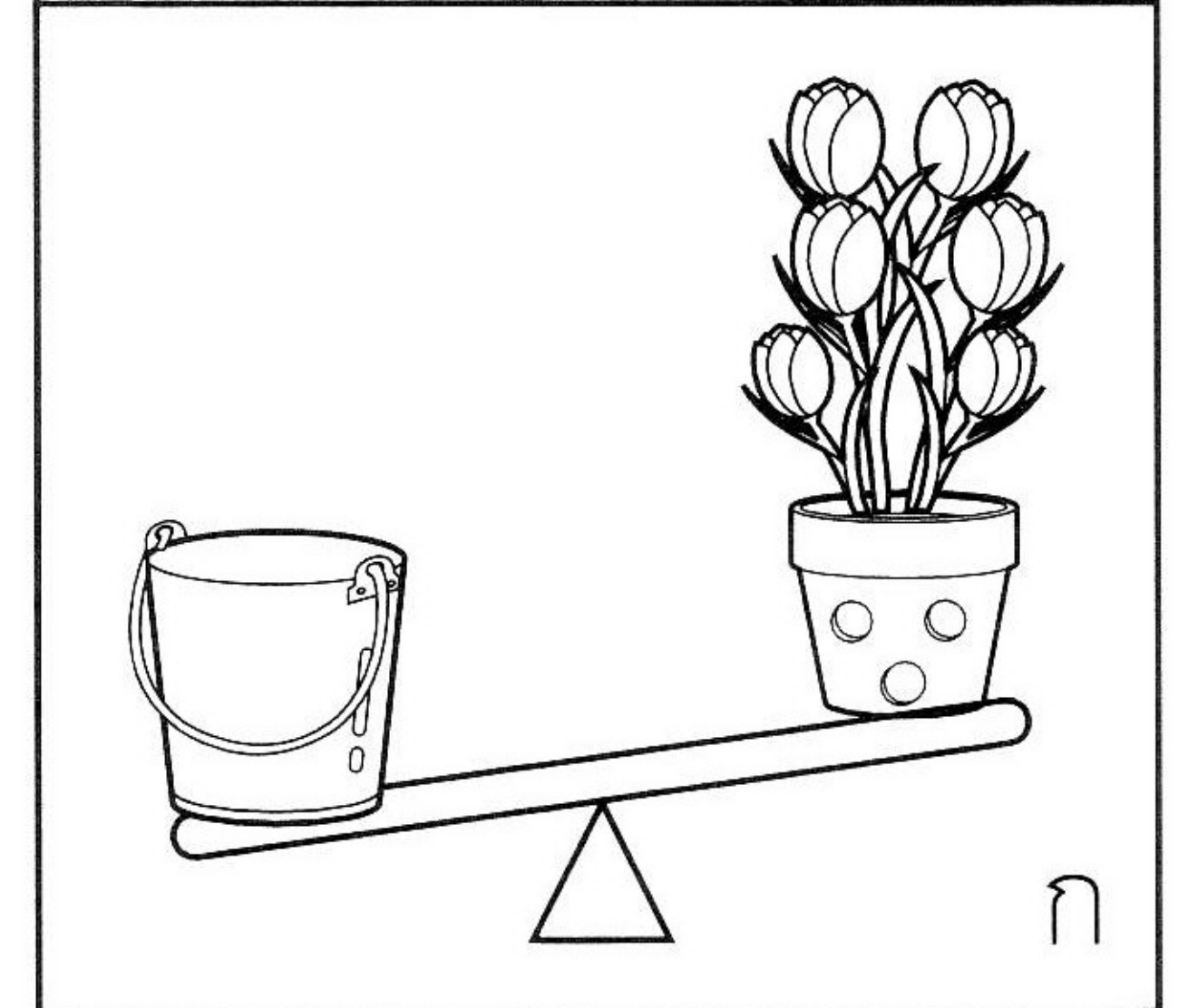
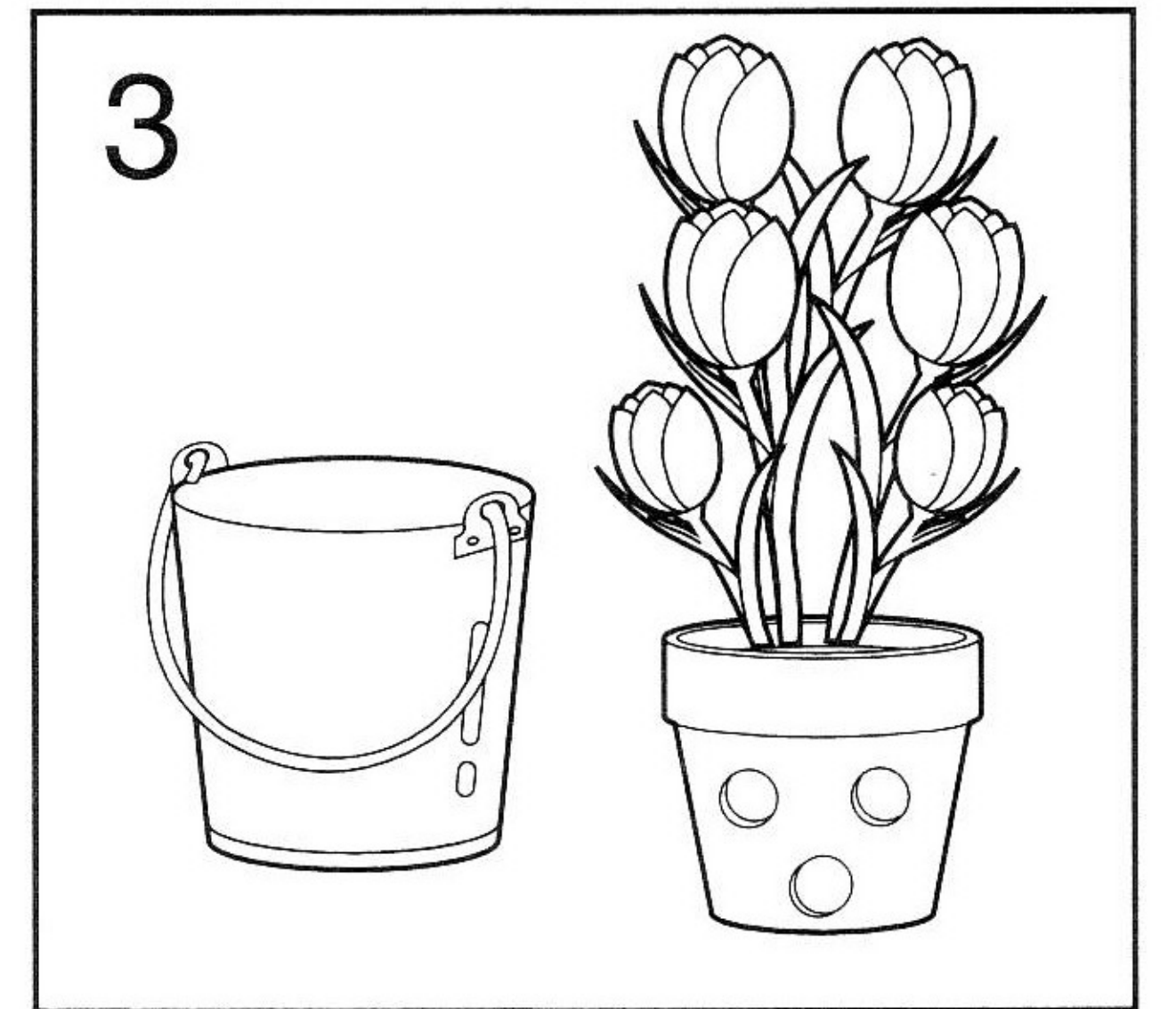
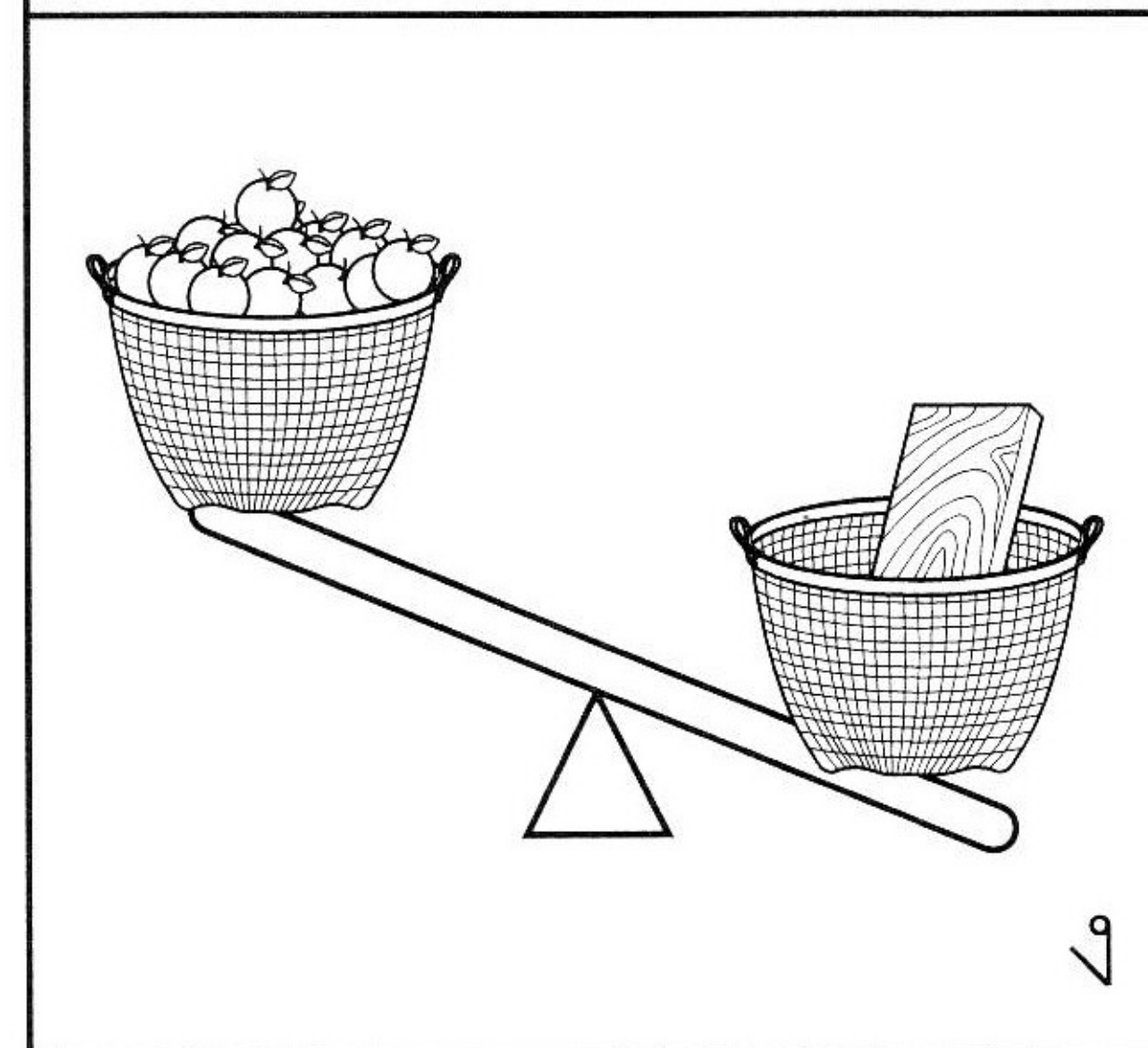
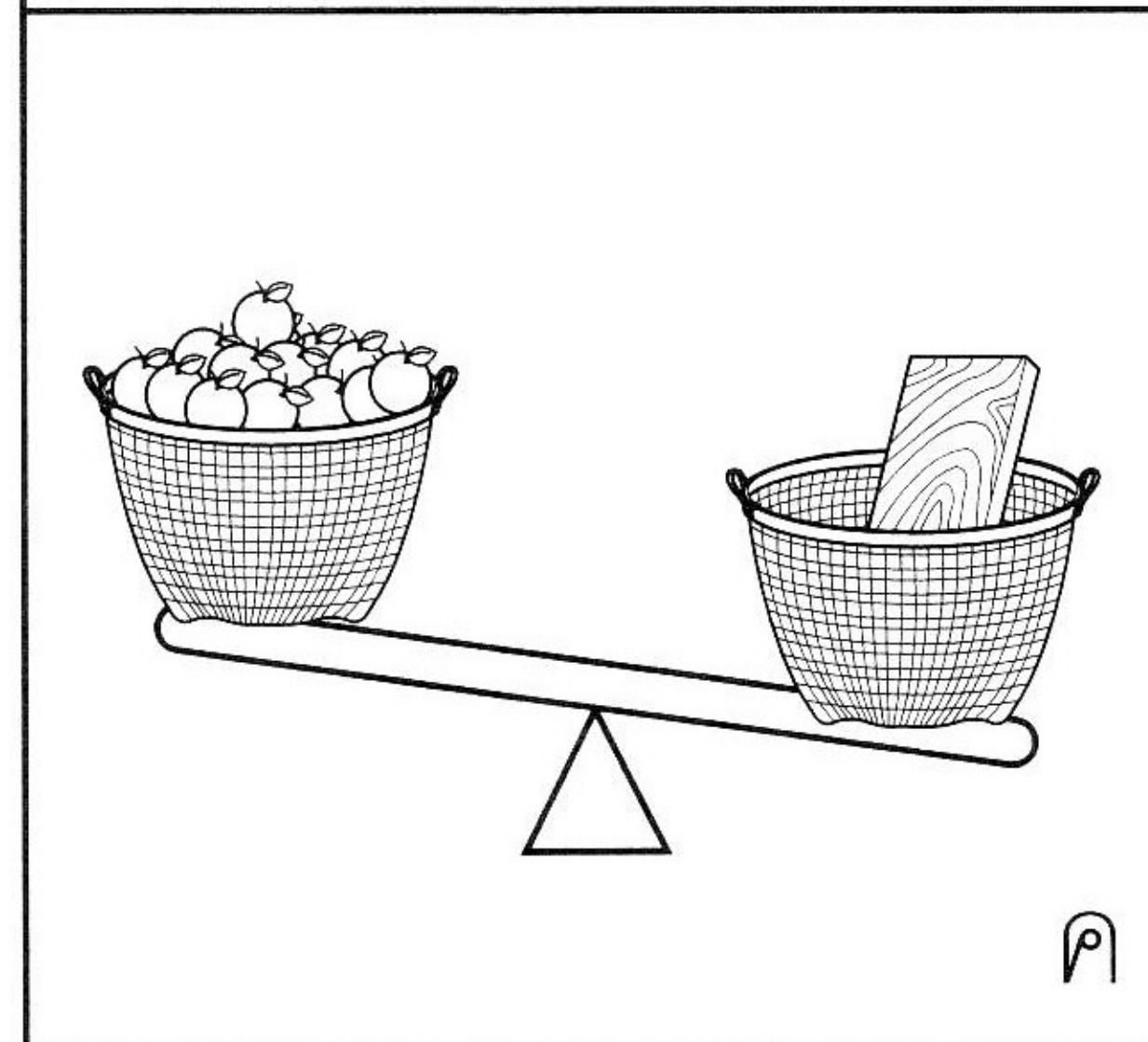
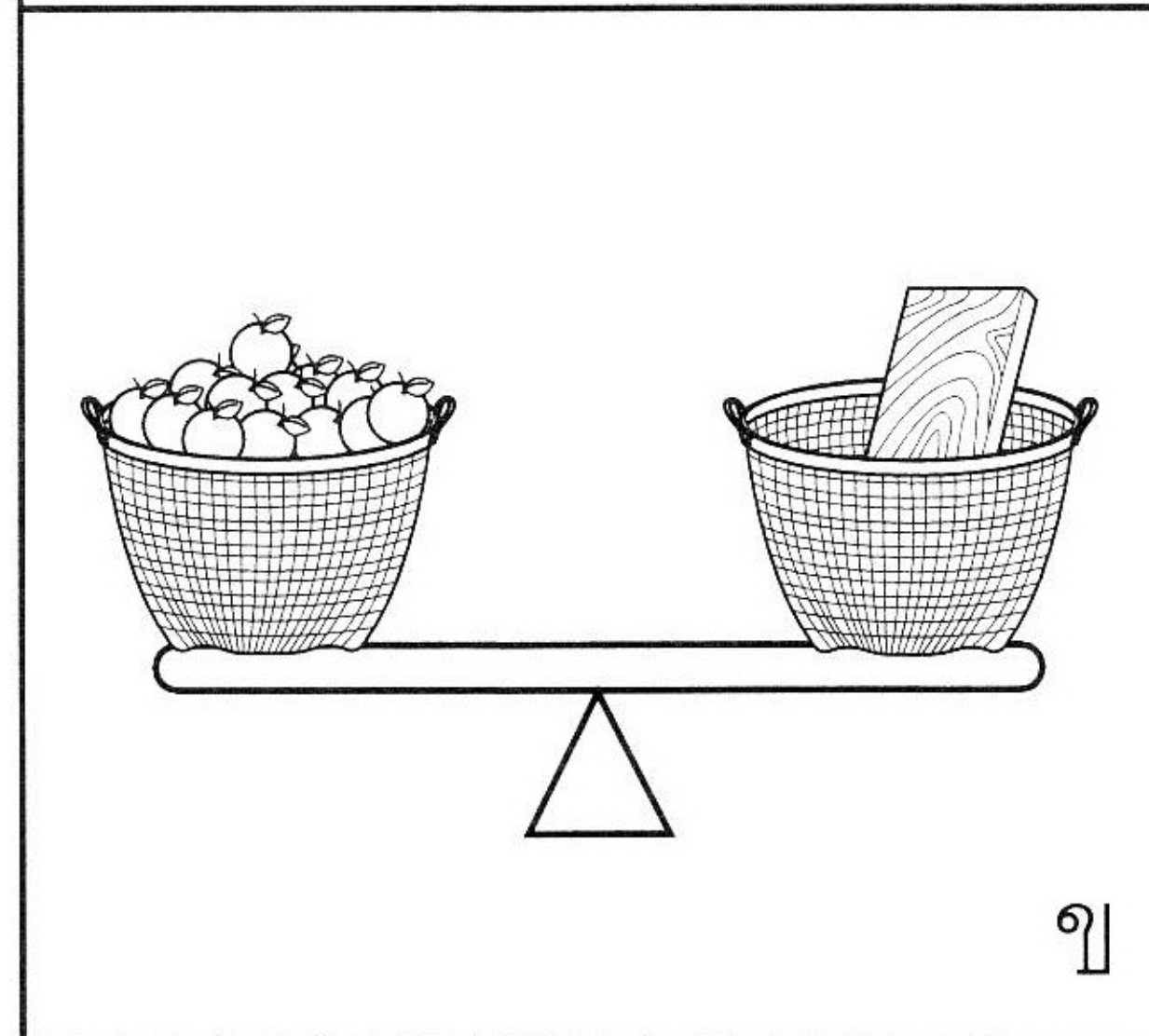
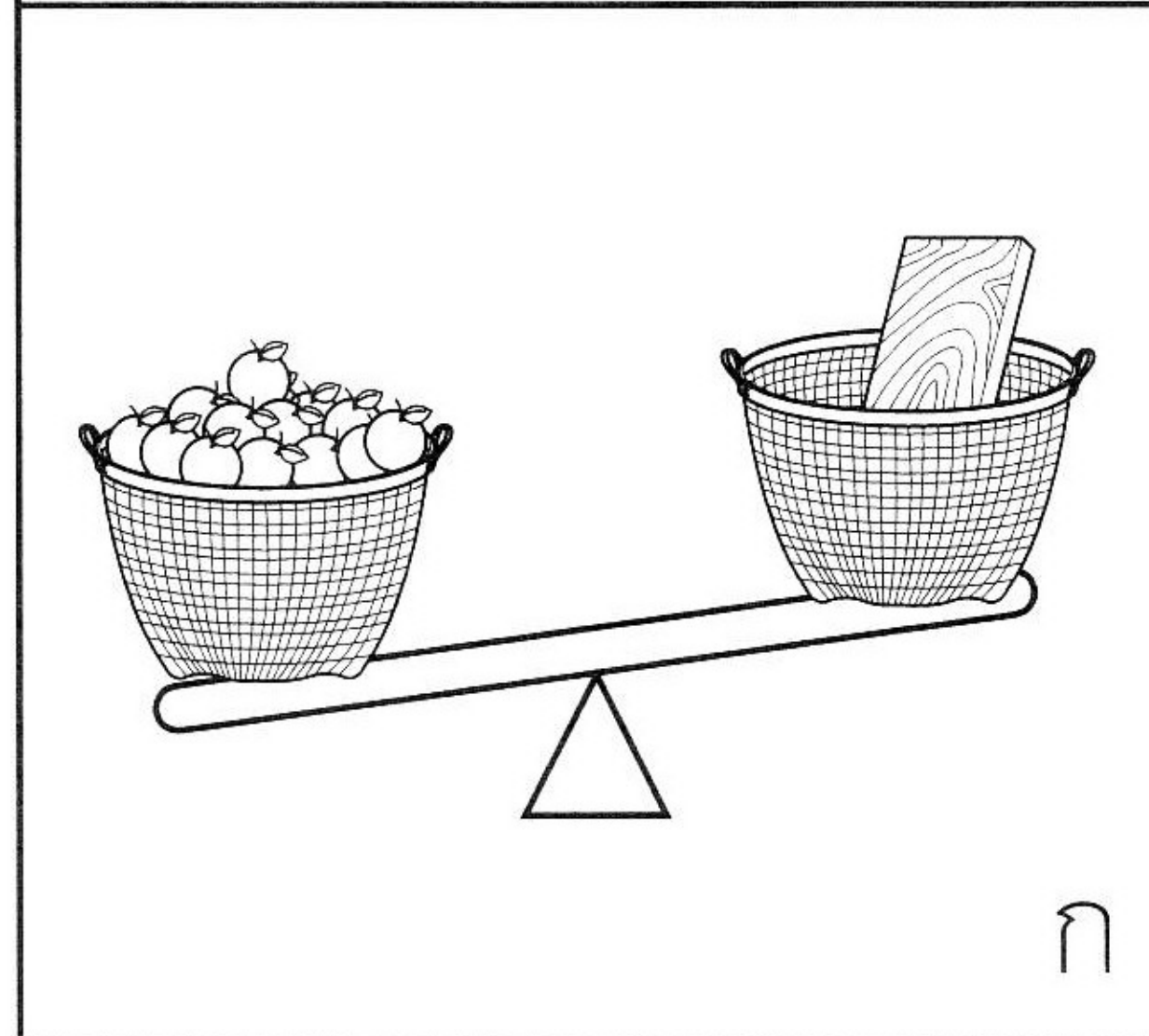
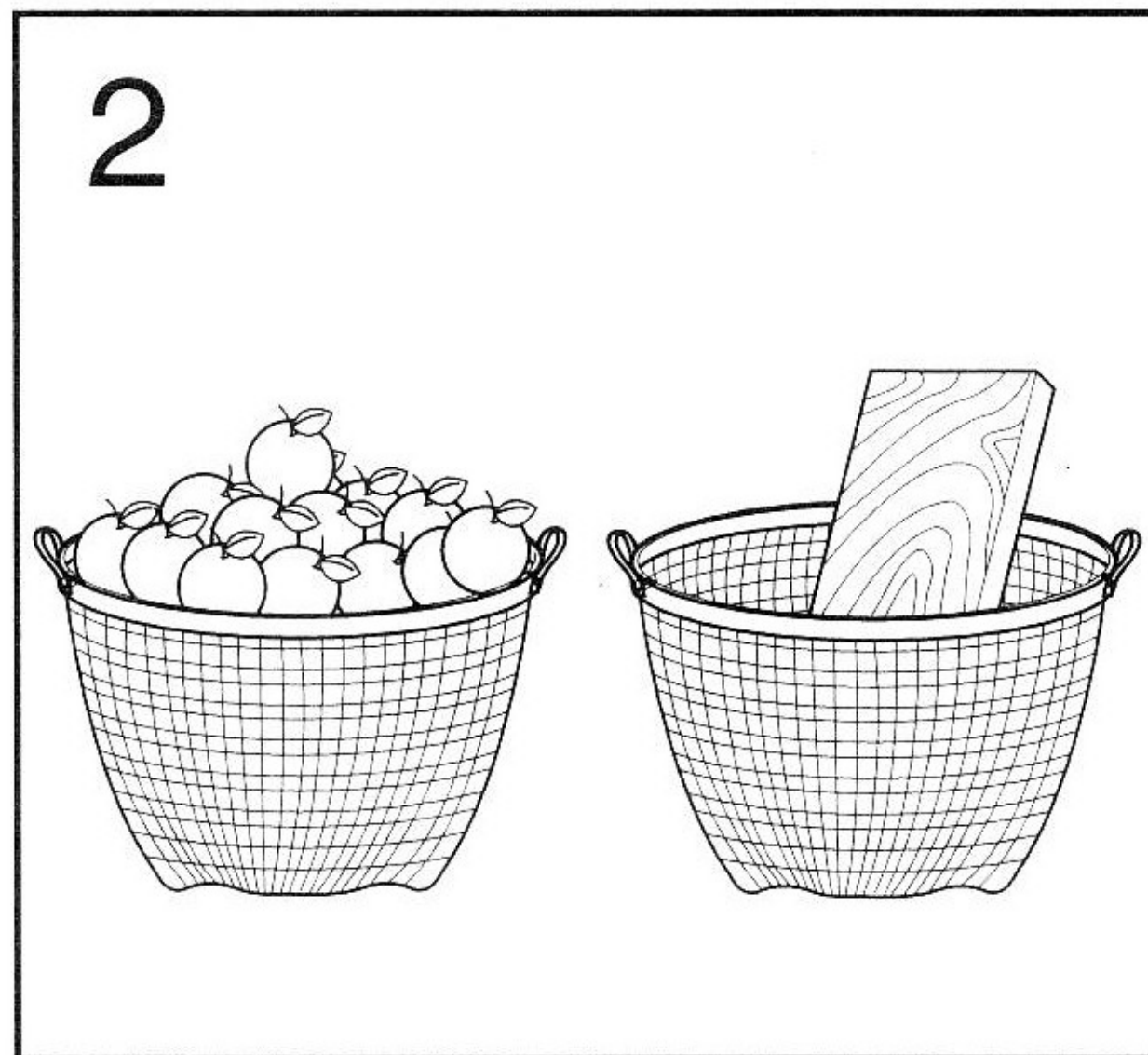
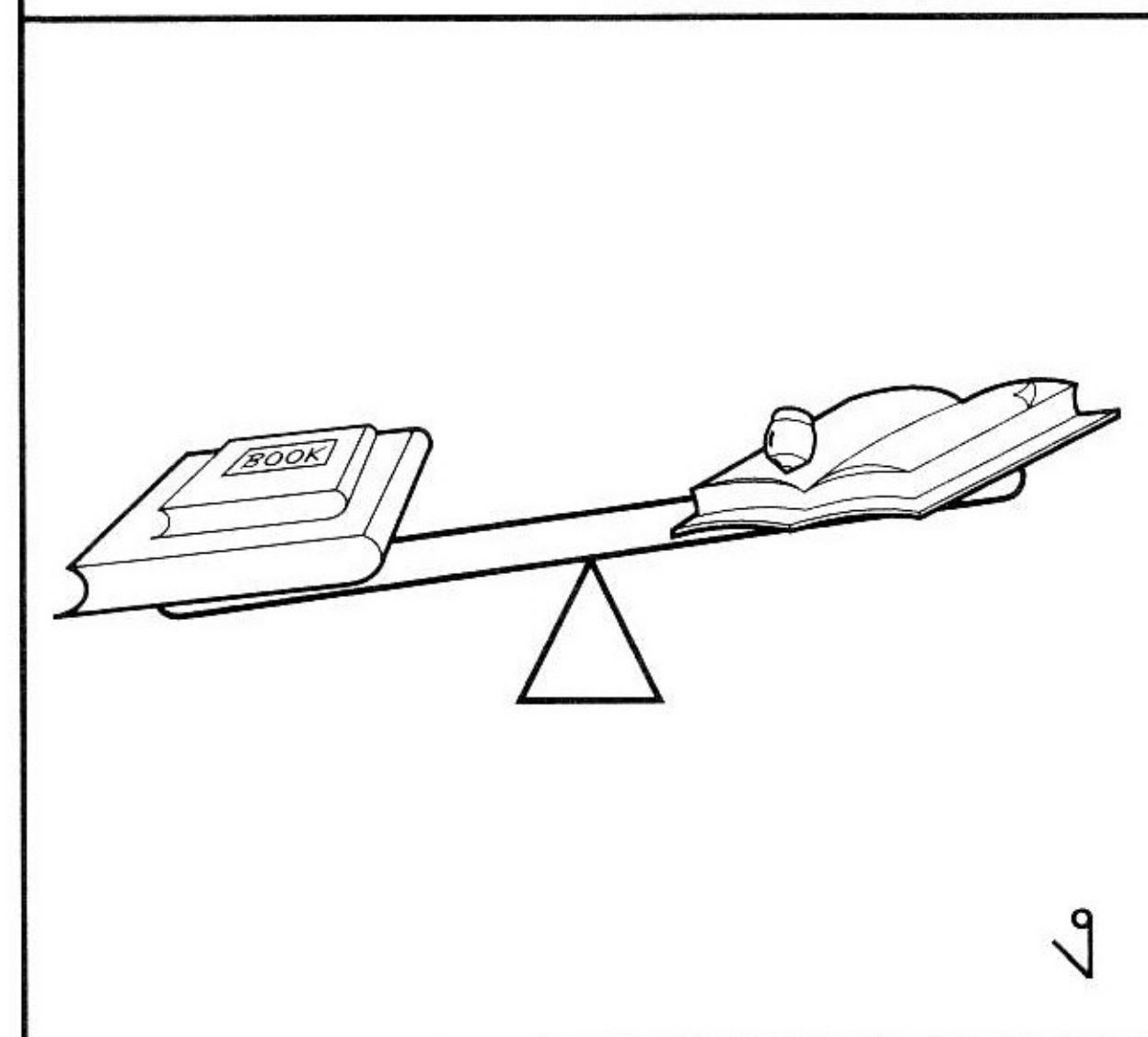
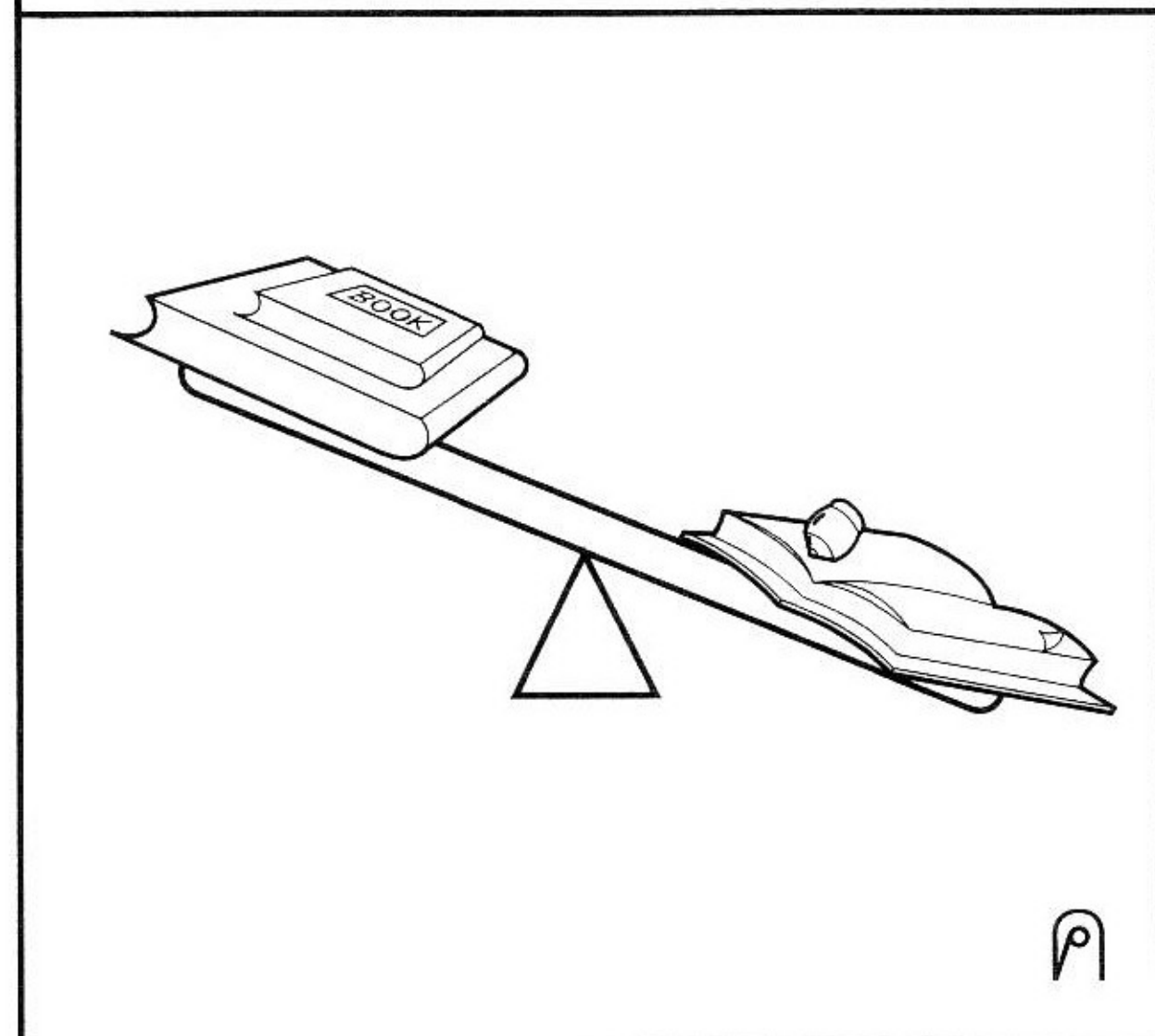
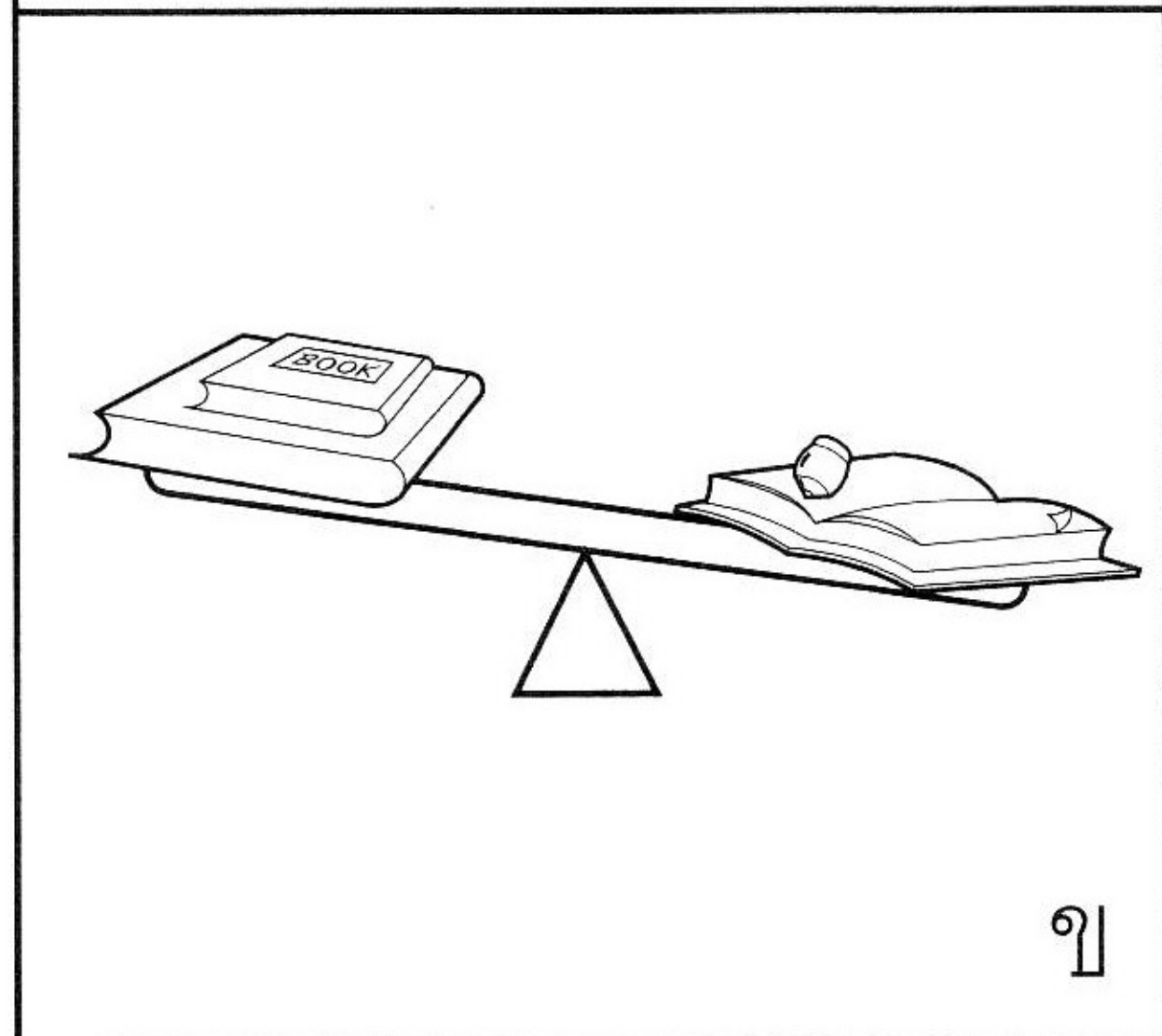
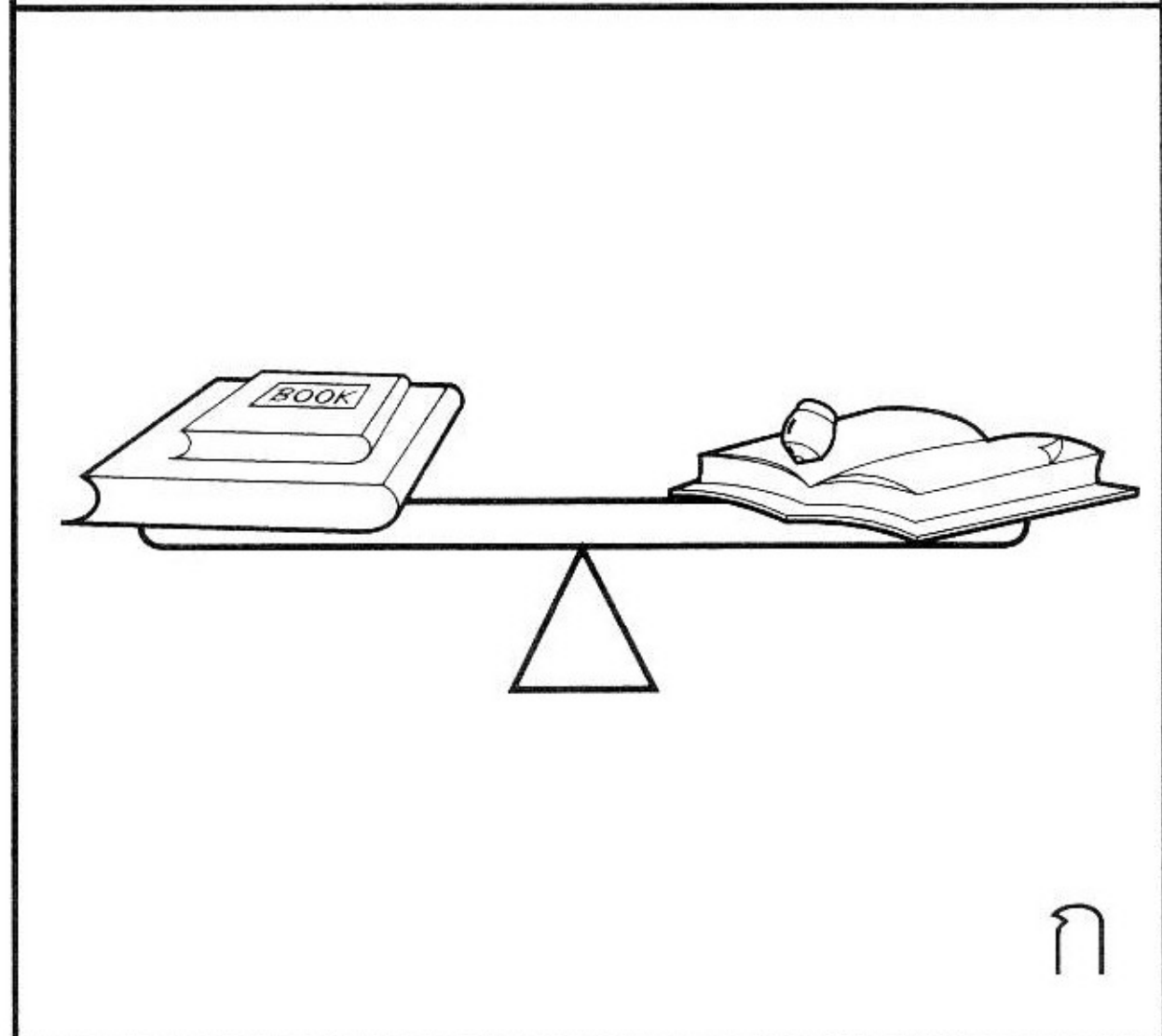
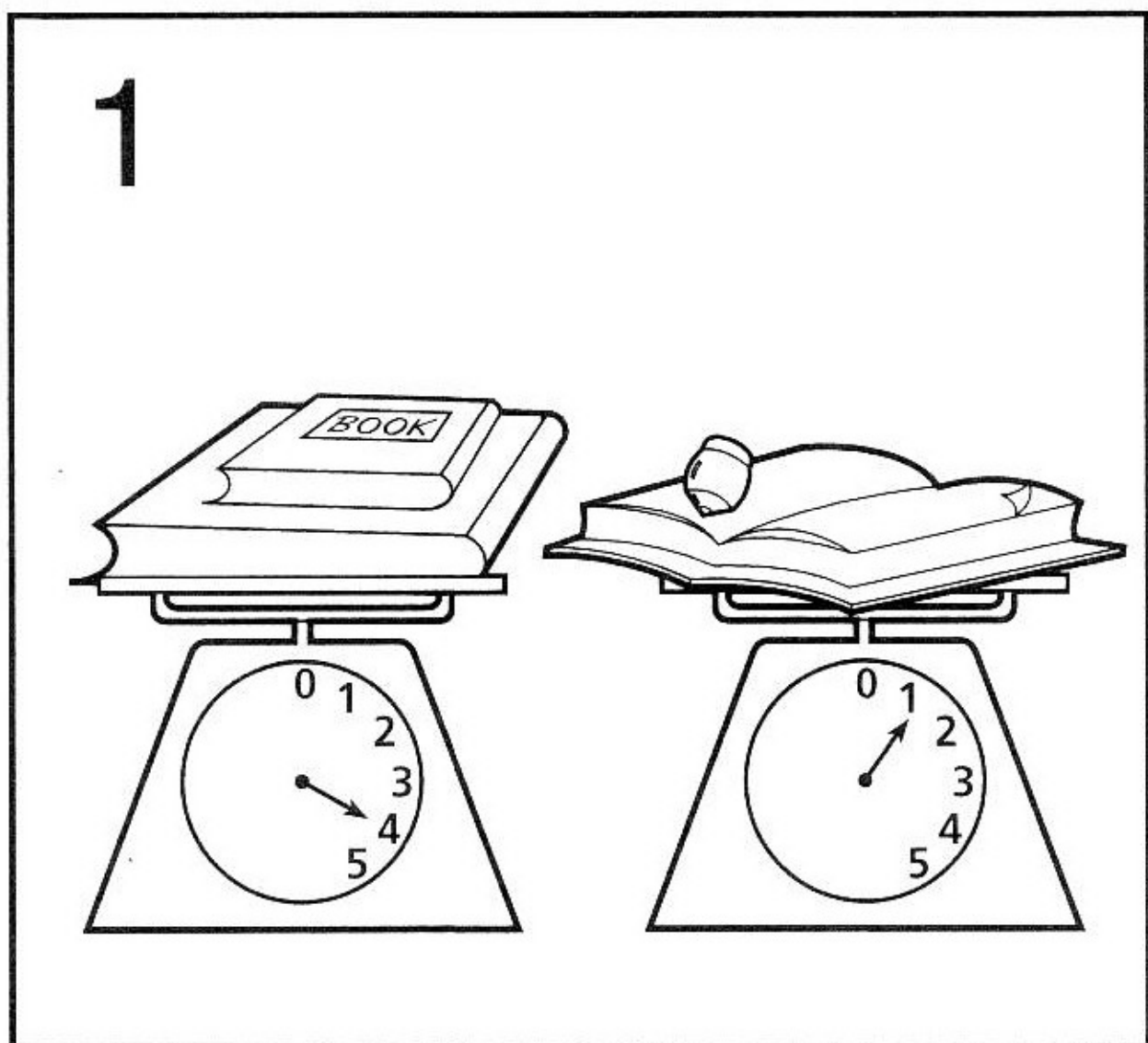

4

5 กิโลกรัม

5 กิโลกรัม

5

11 10 9 8 7 6 5 4 3 2 1 0

11 10 9 8 7 6 5 4 3 2 1 0

6

ก

ก

ก

ข

ข

ข

ค

ค

ค

ง

ง

ง

7

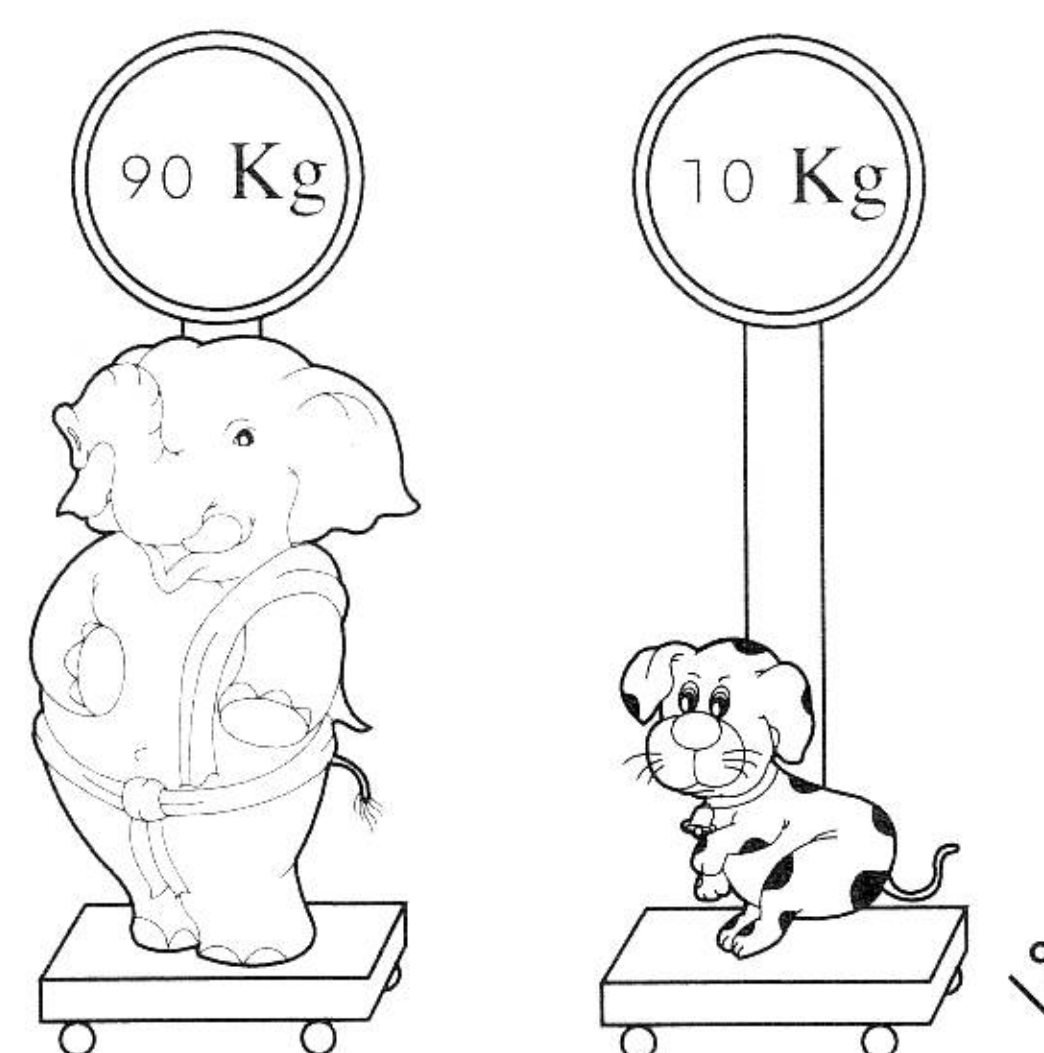
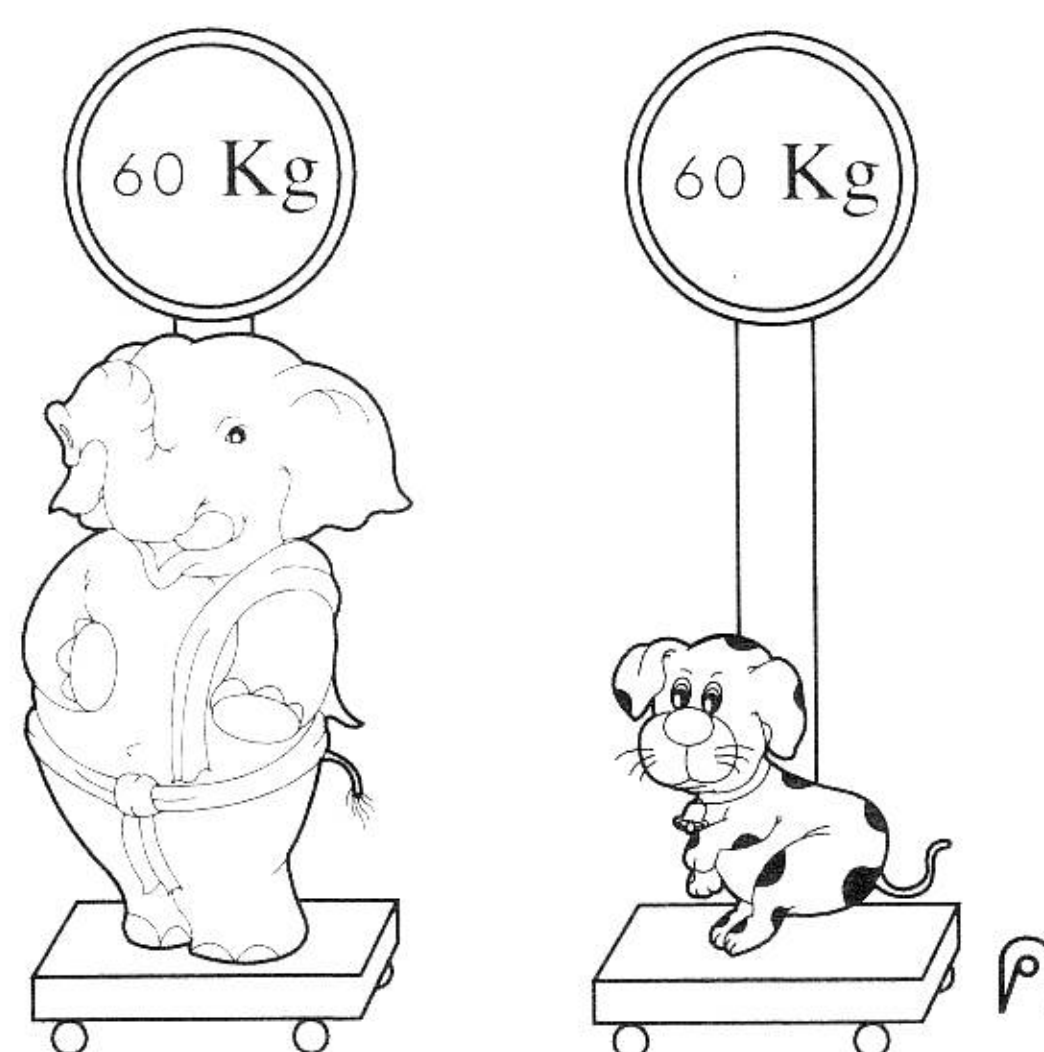
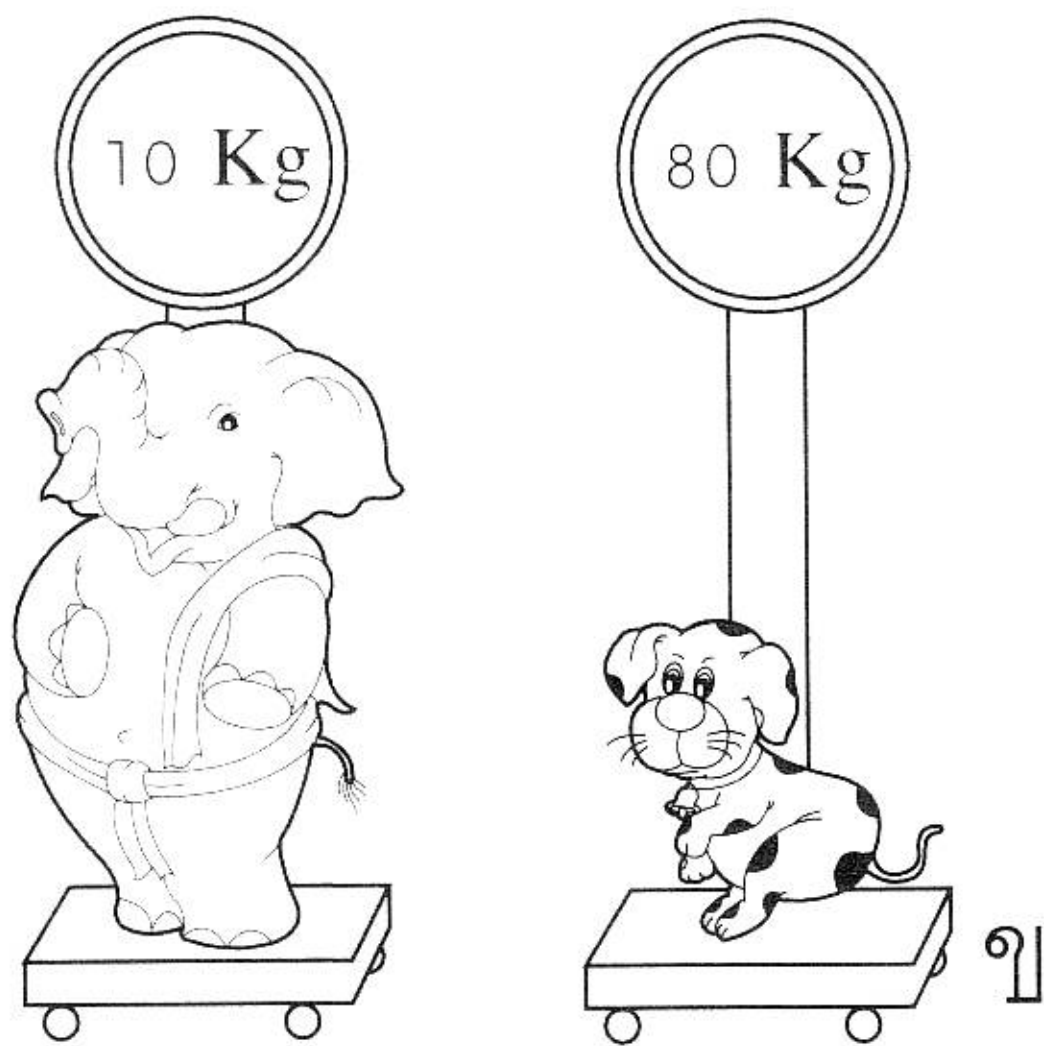
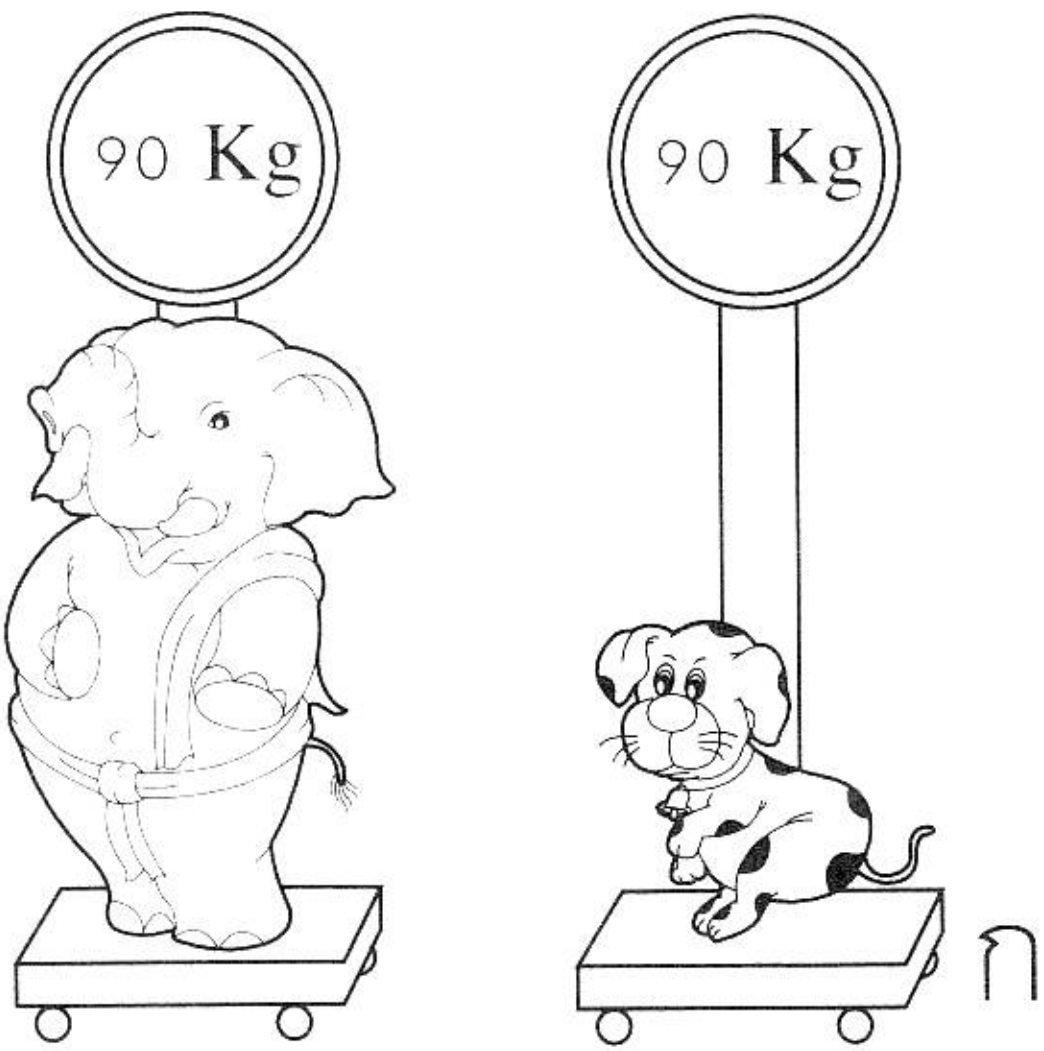
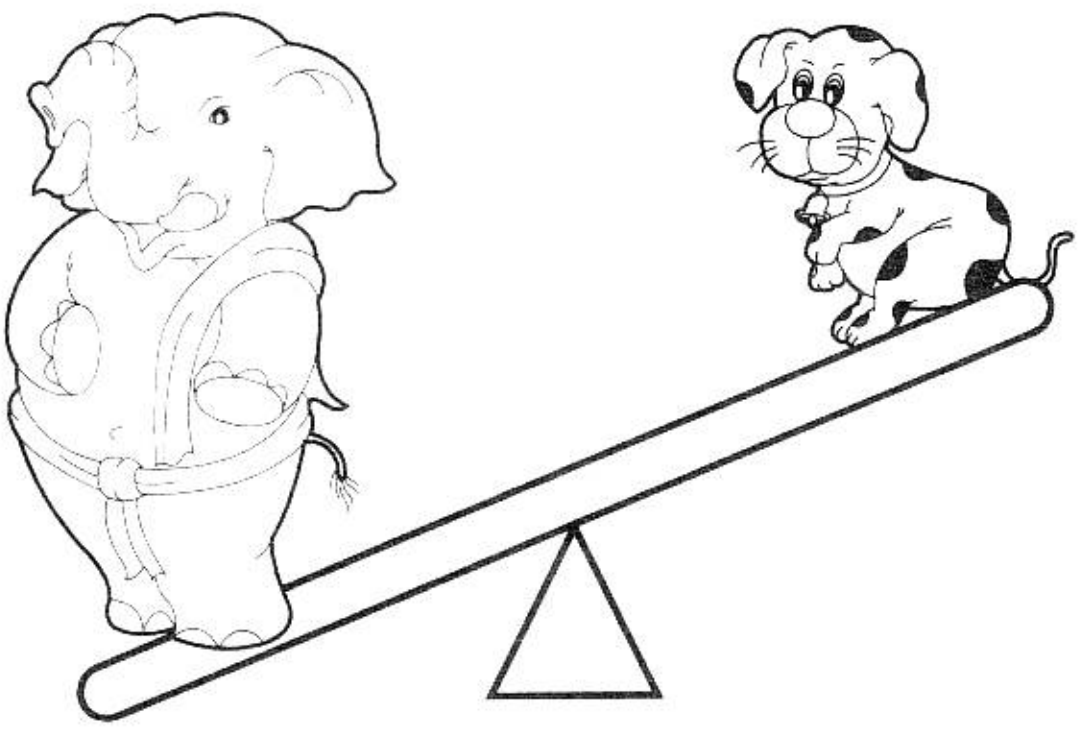

8

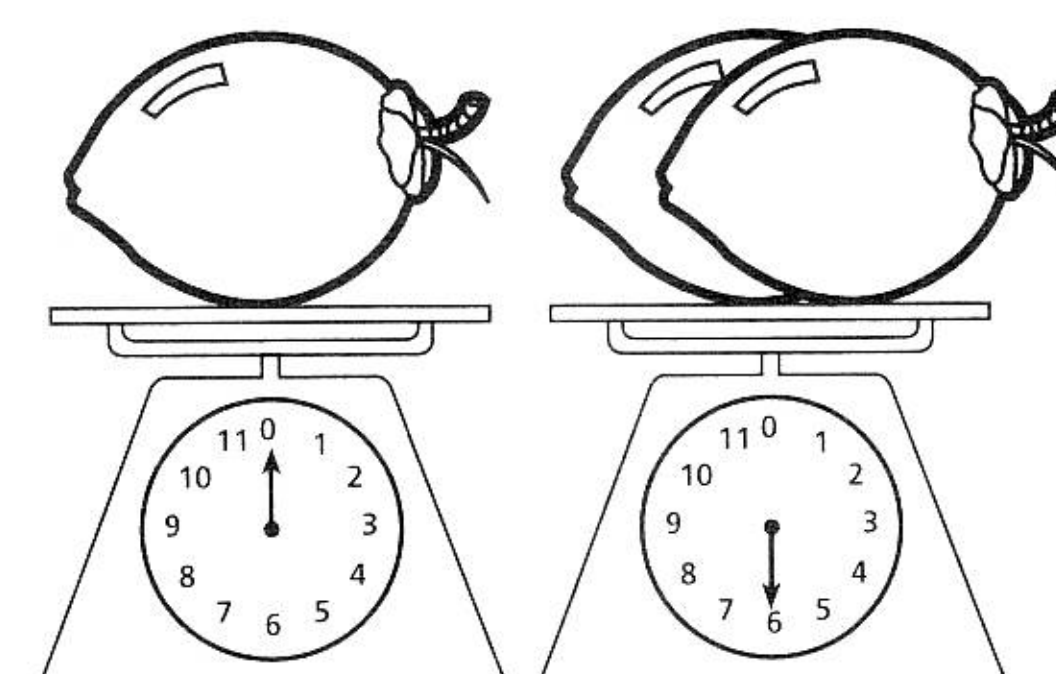
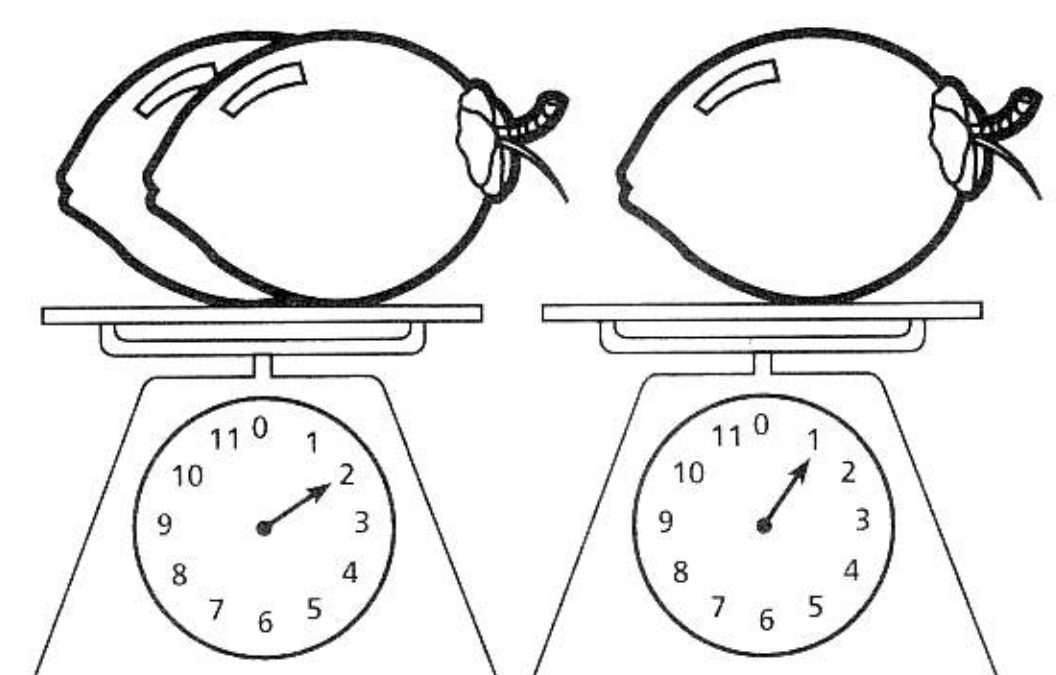
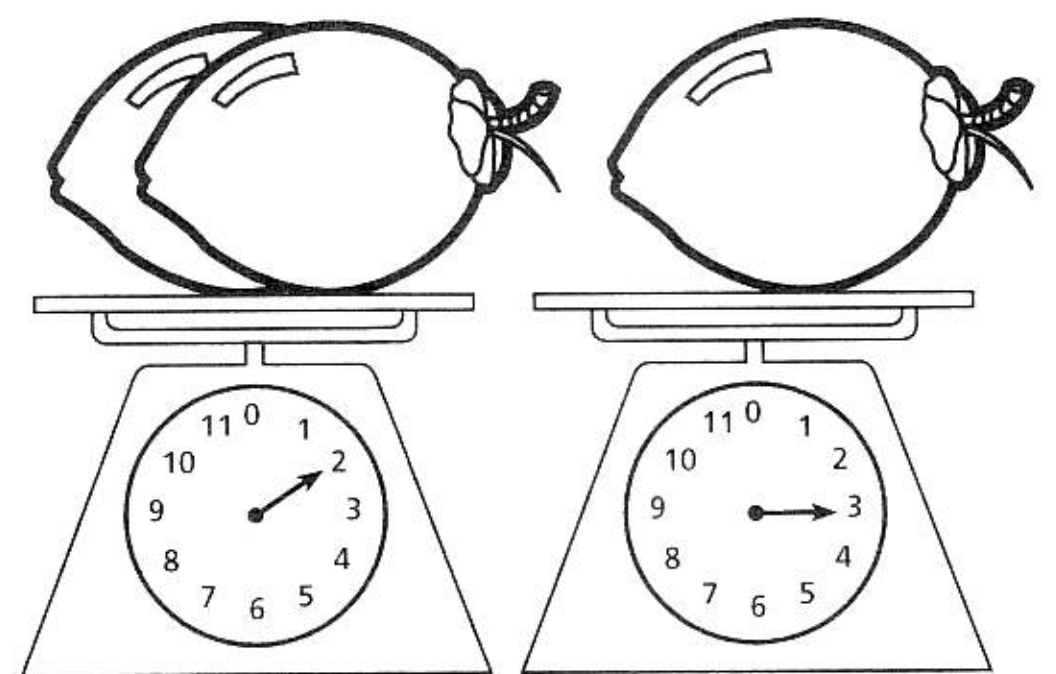
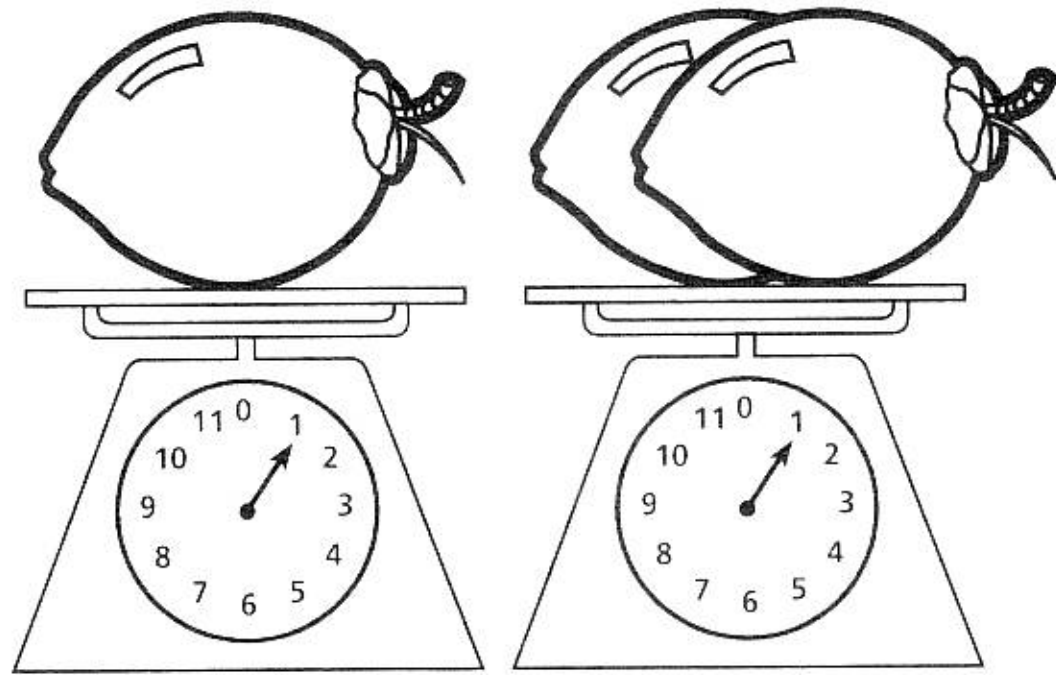

9

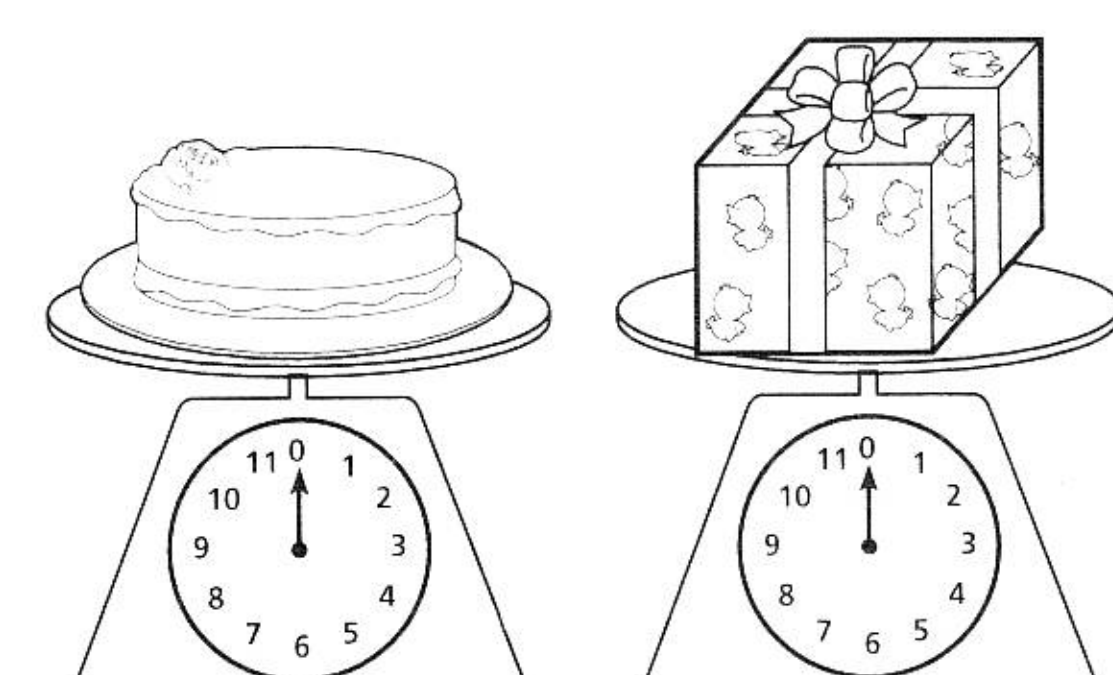
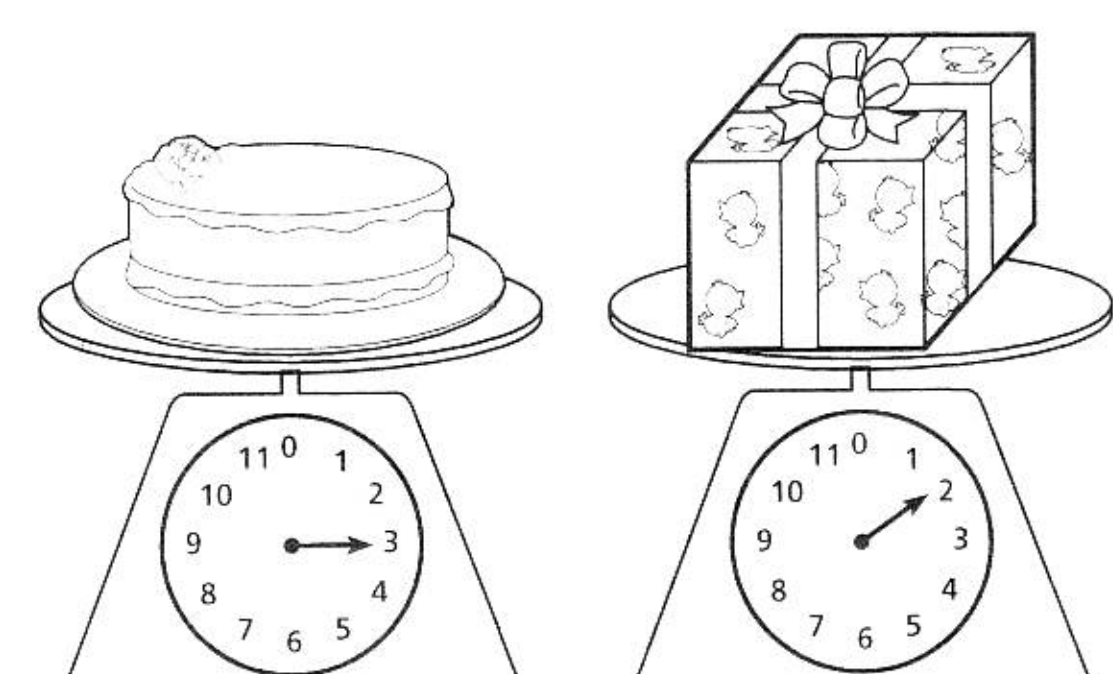
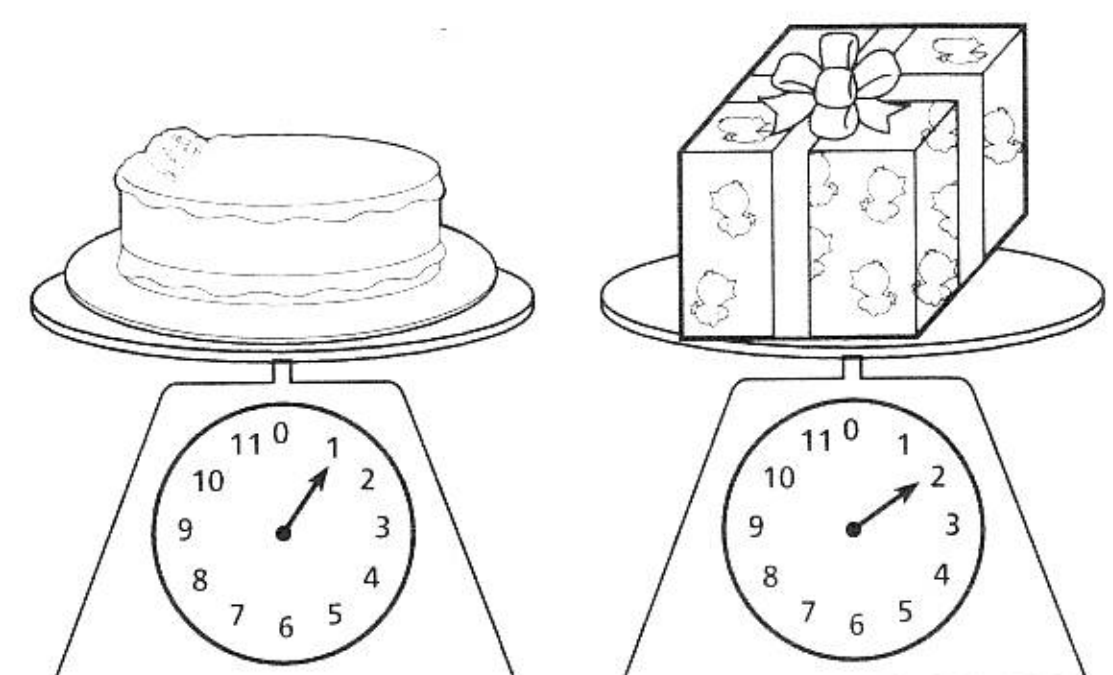
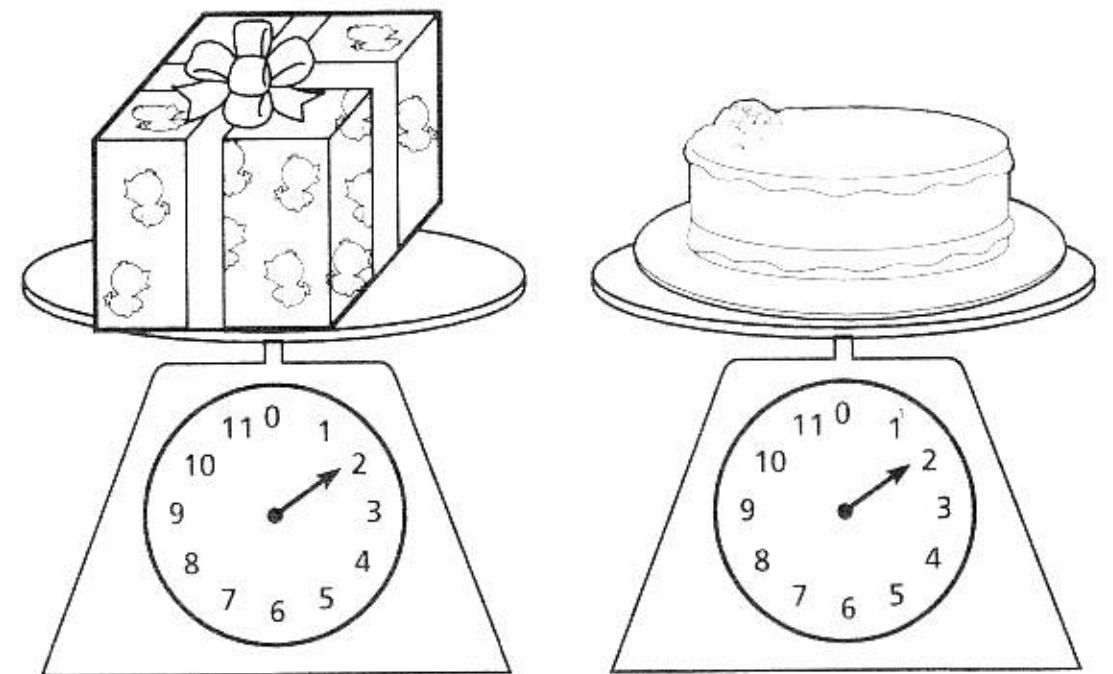
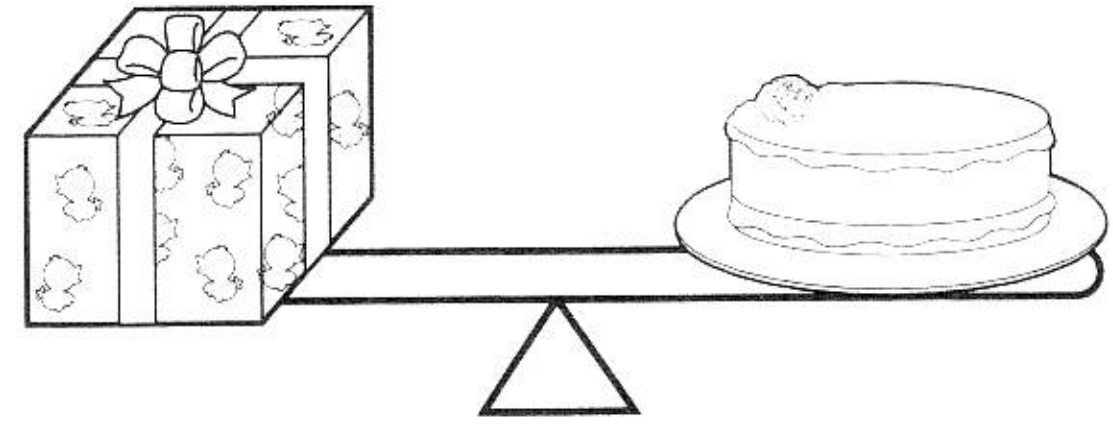

10

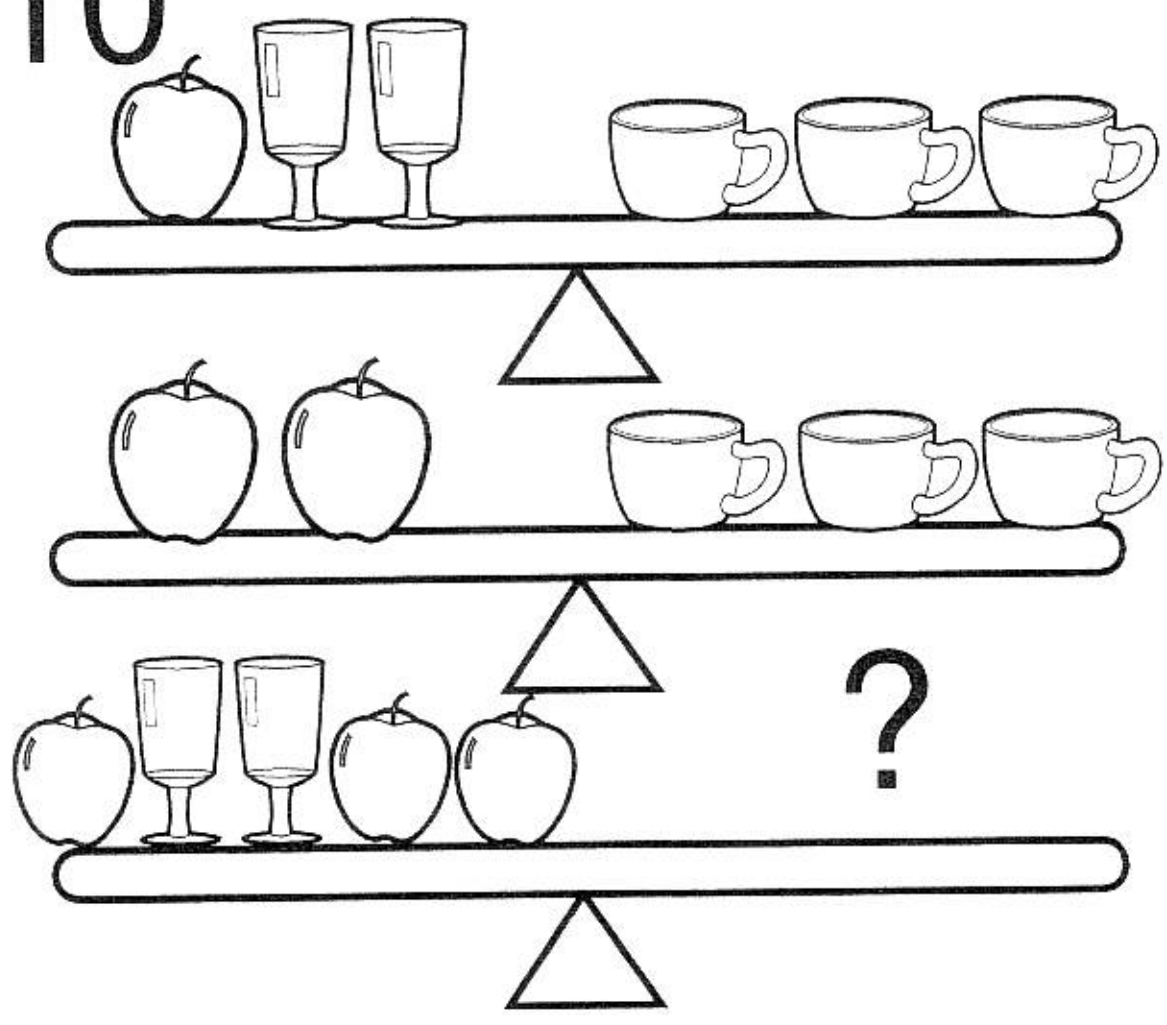

၈



၅



၆

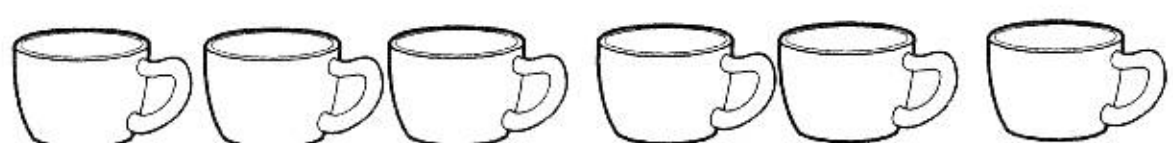

၆

11

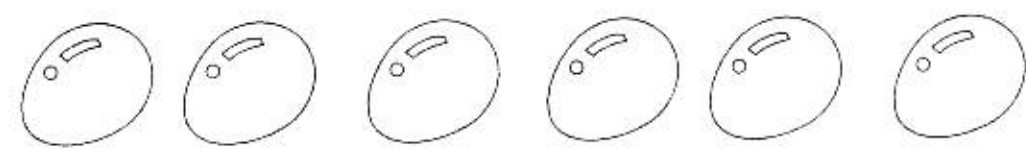
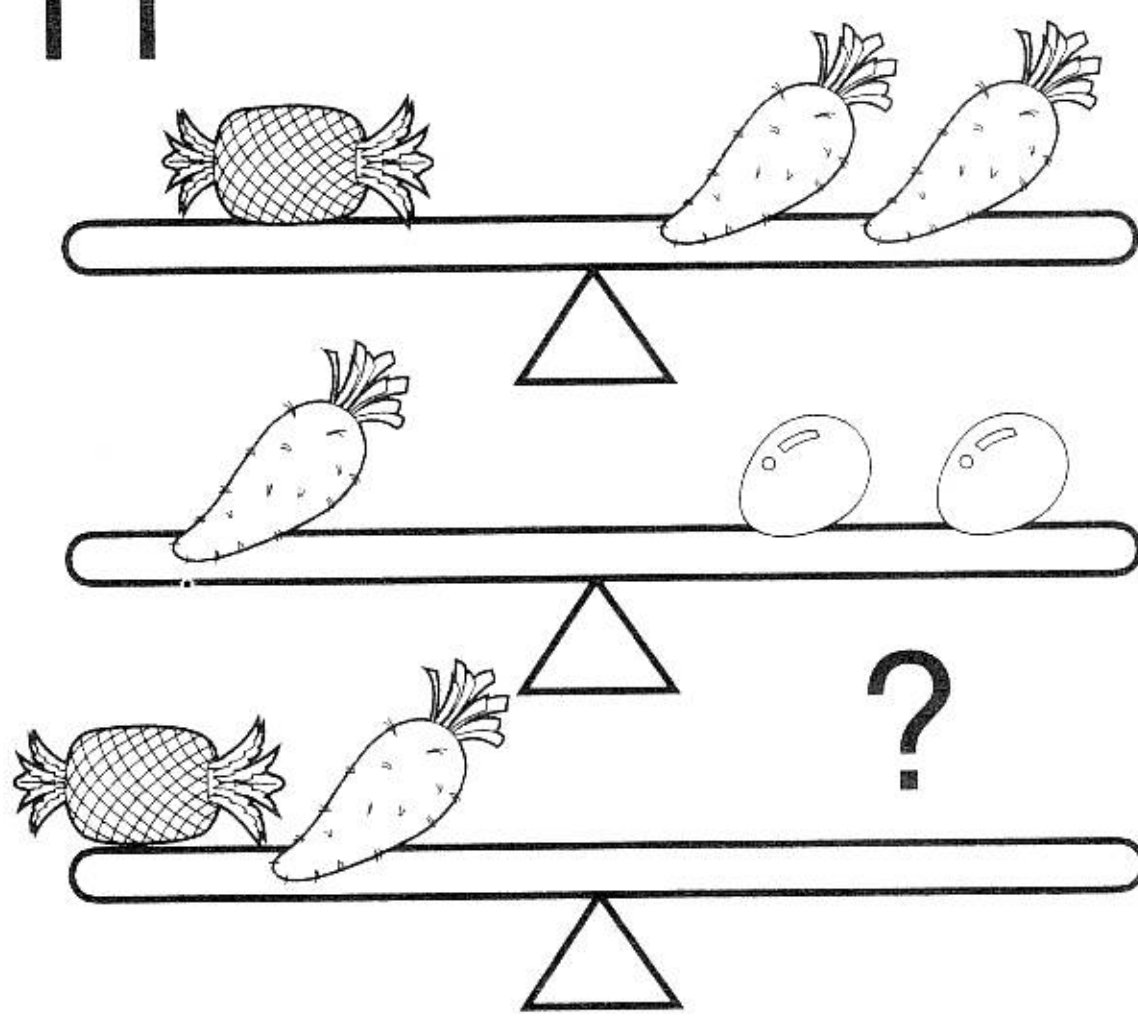

၈



၅

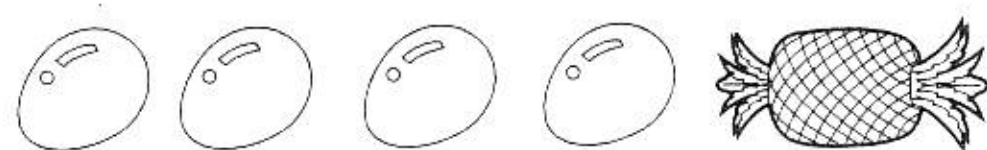

၆

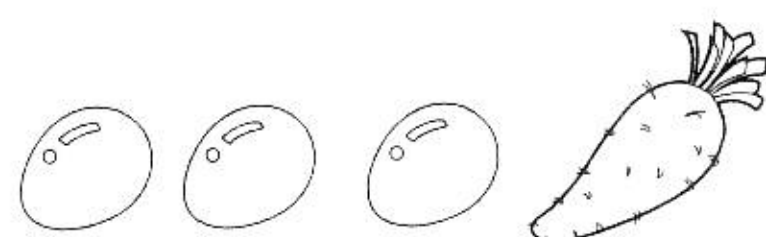

၆

12

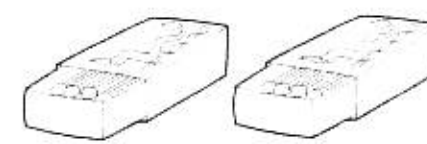
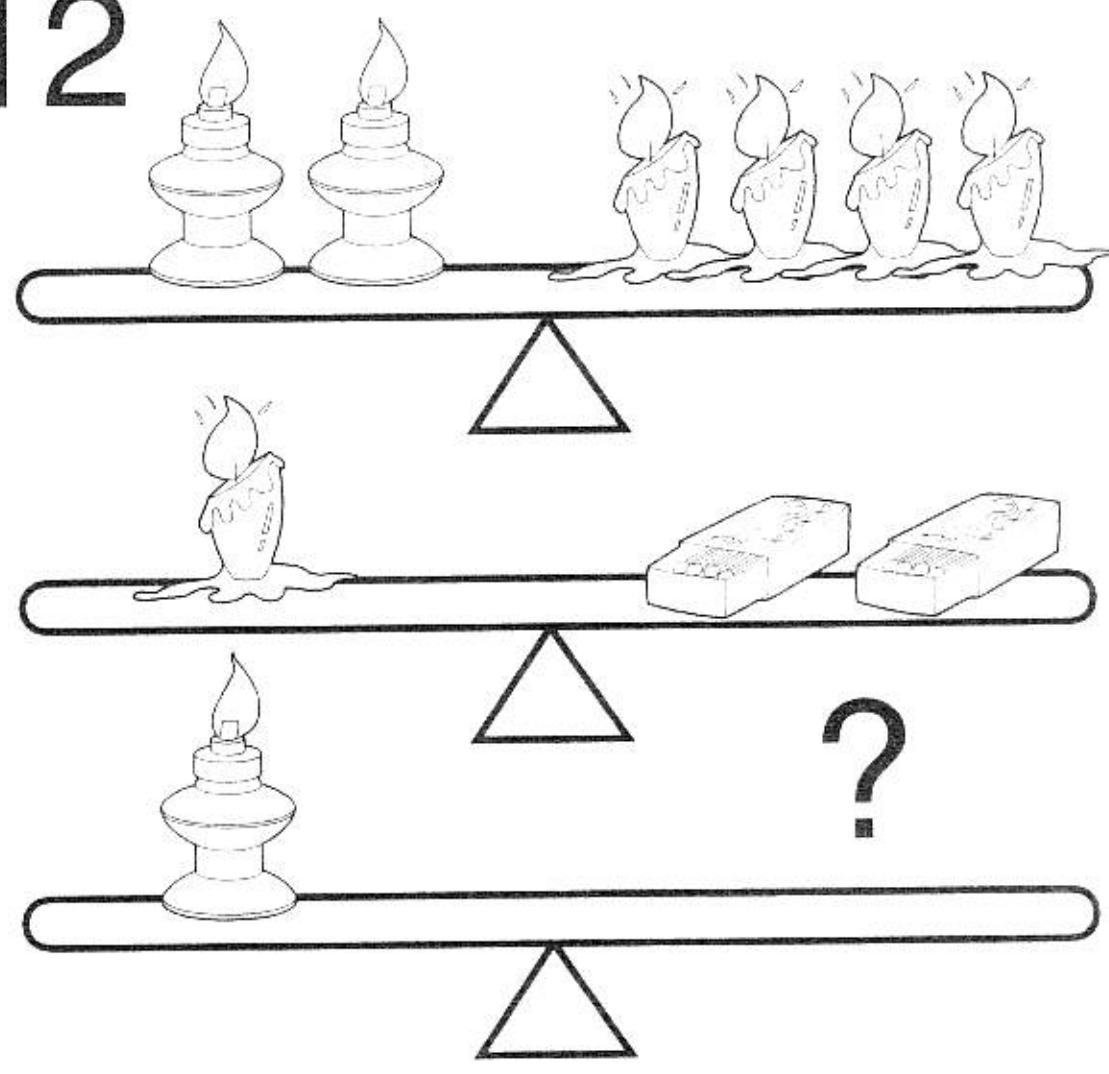

၈



၅

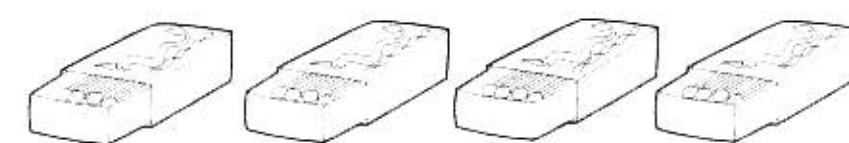

၆



၆

13

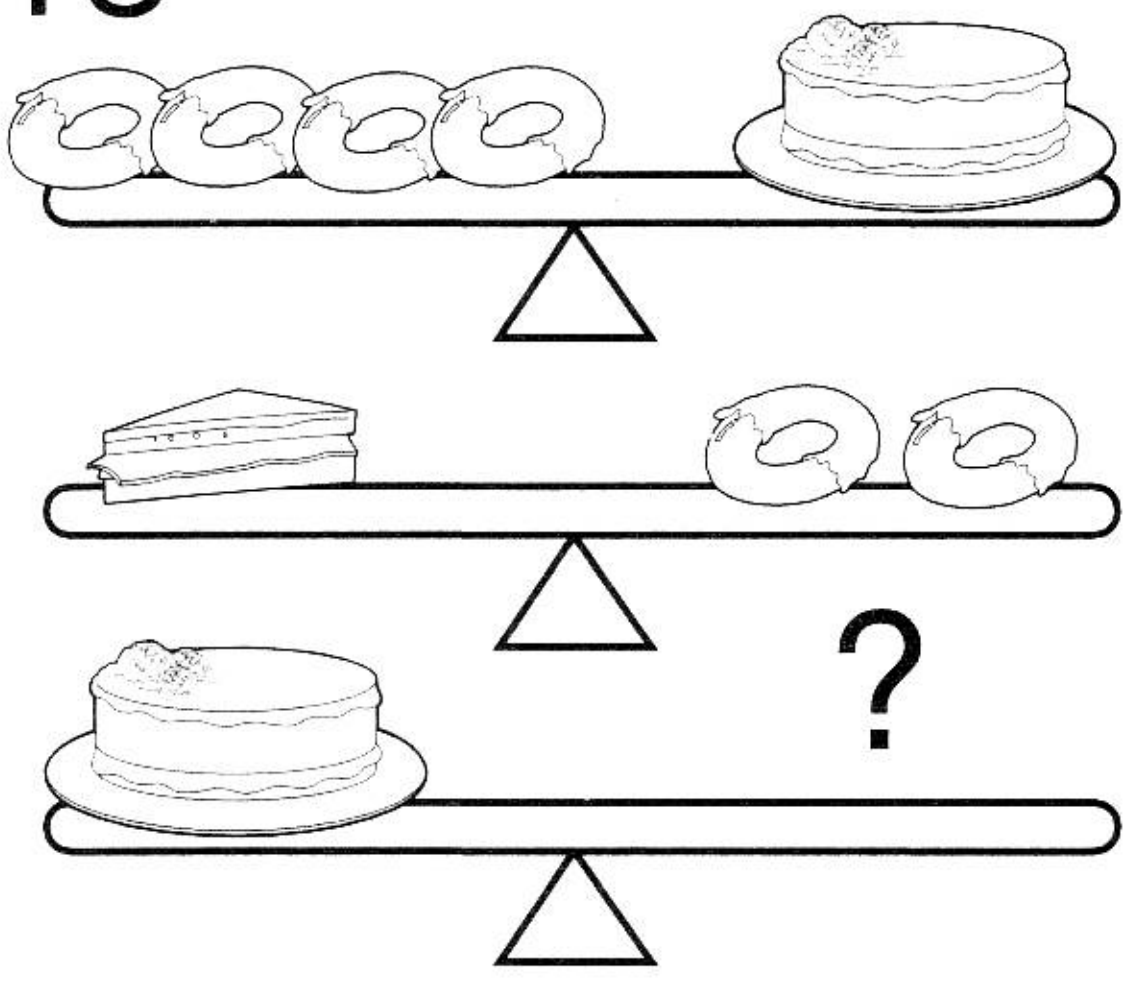

ဂ

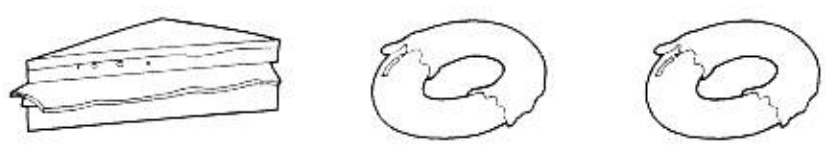

ဈ

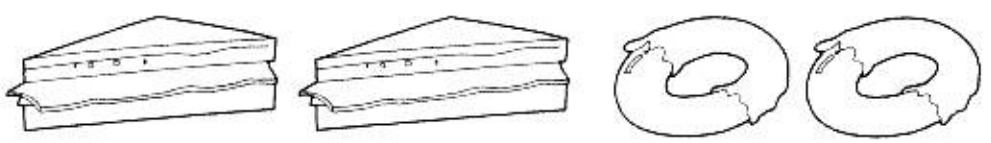

ဃ

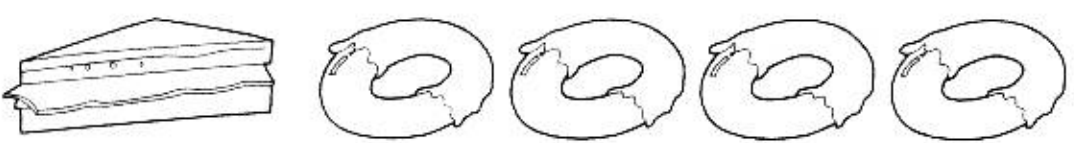

၇

14

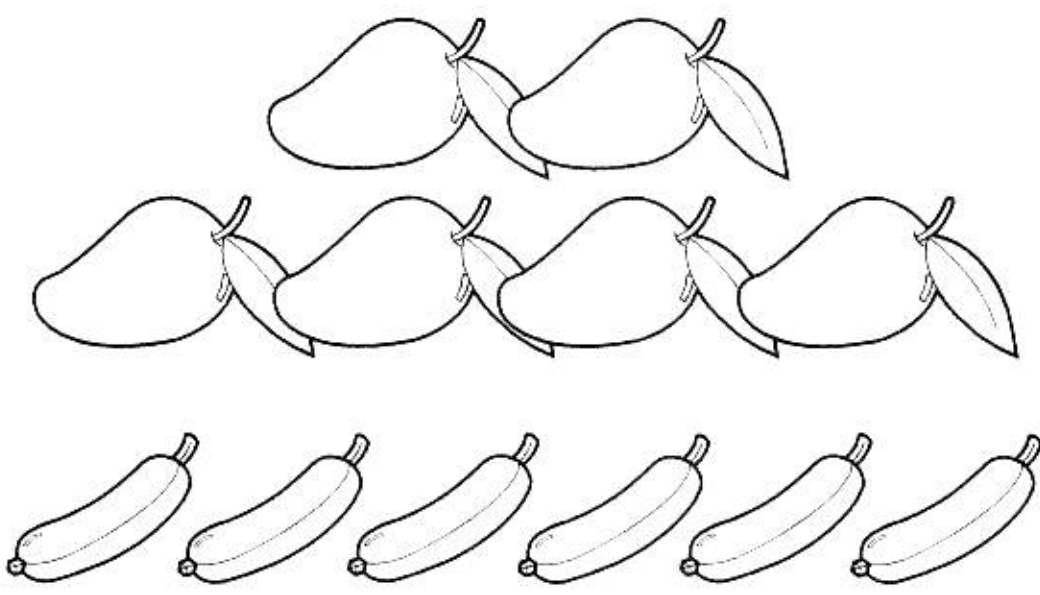
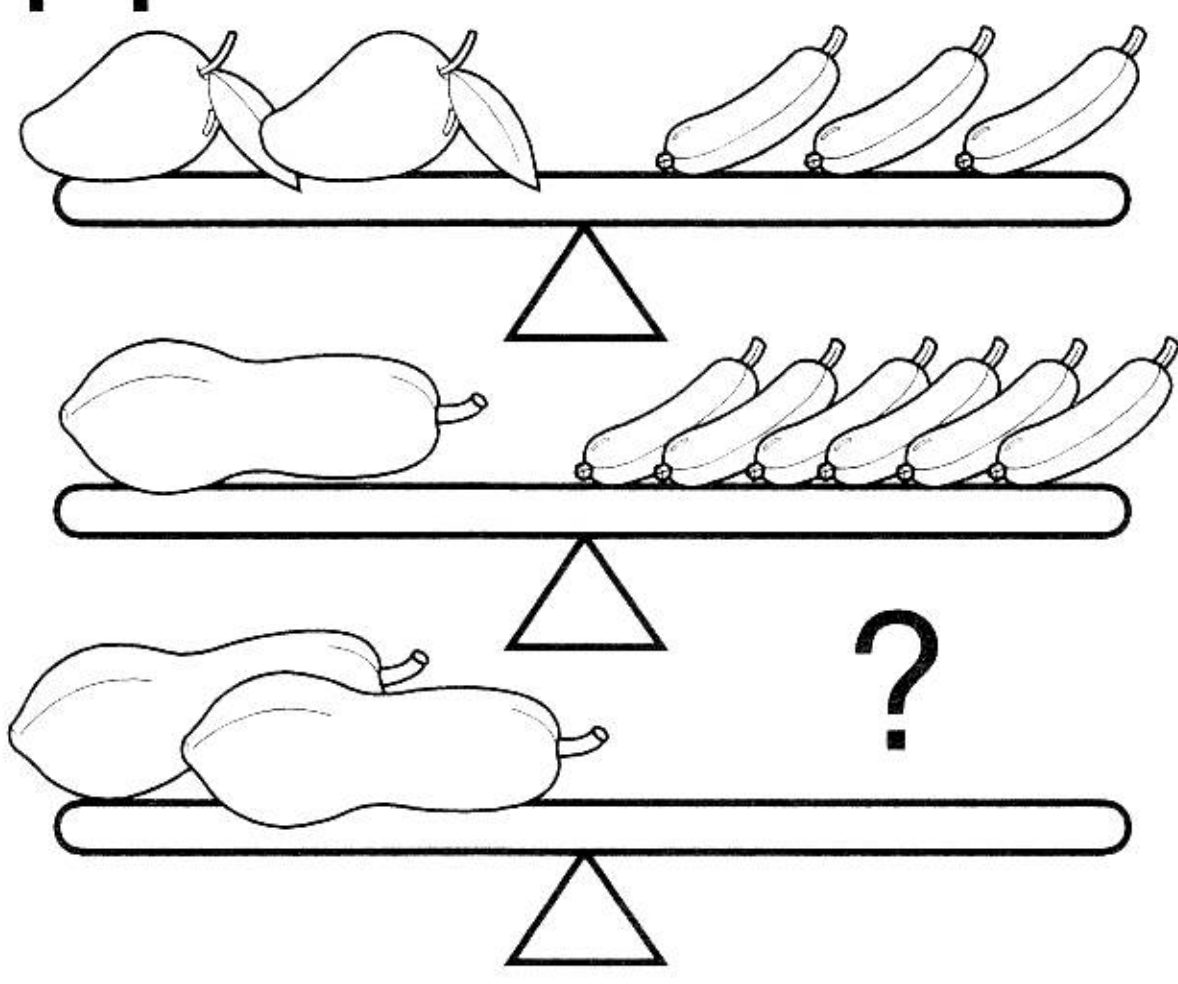

ဂ

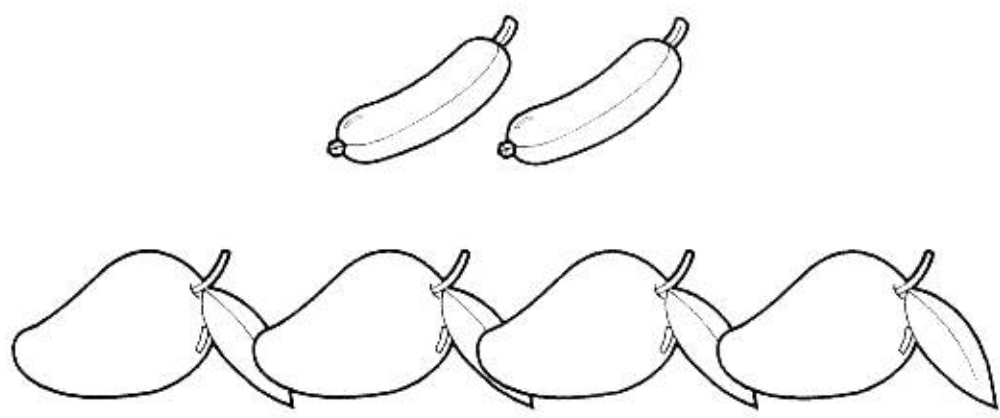

ဈ

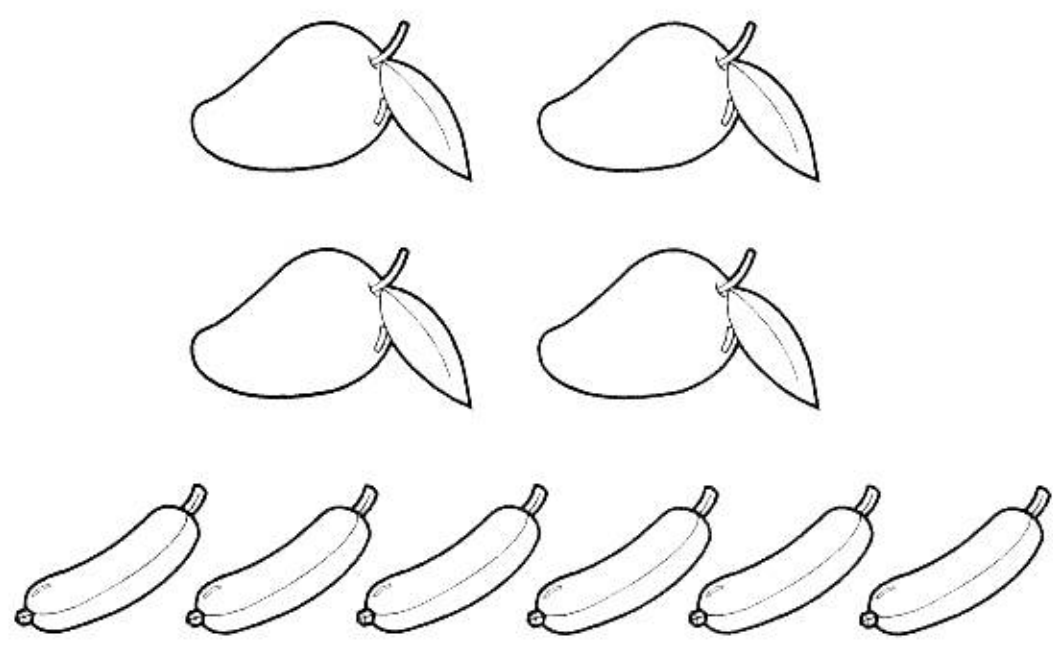

ဃ

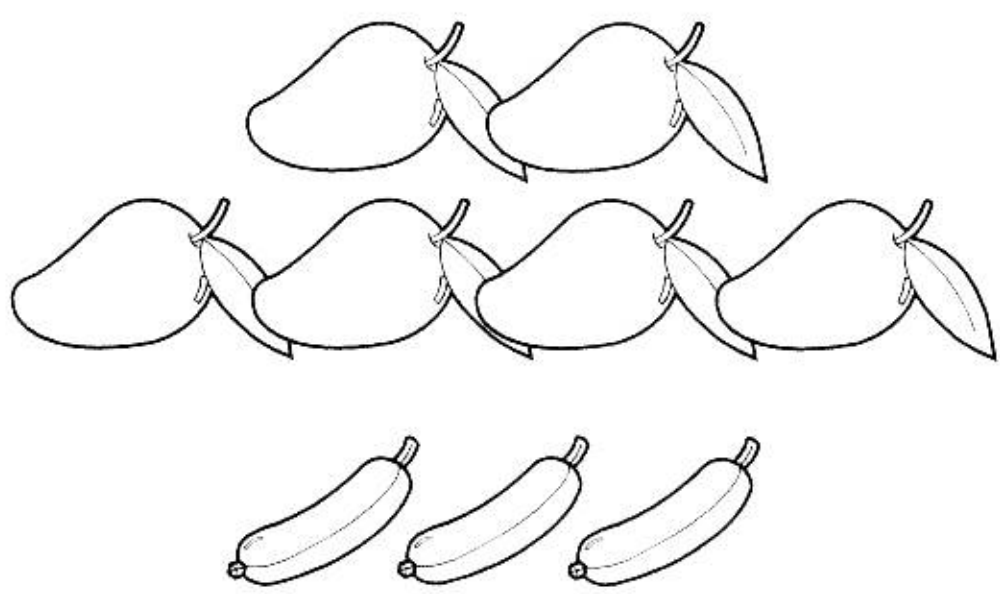

၇

15

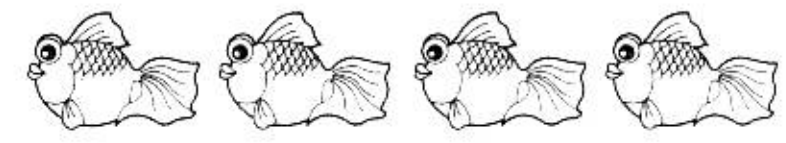
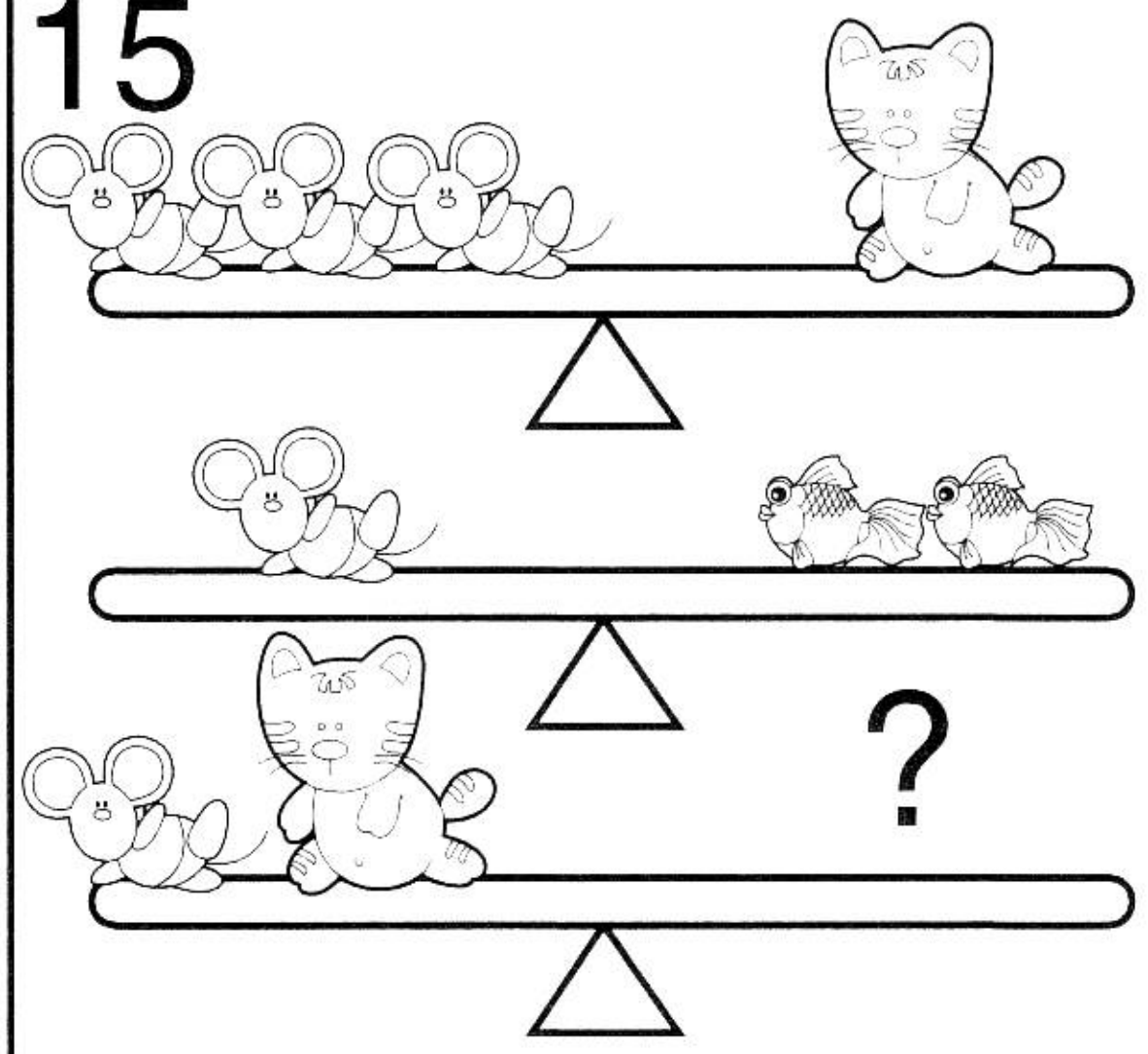

ဂ



ဈ

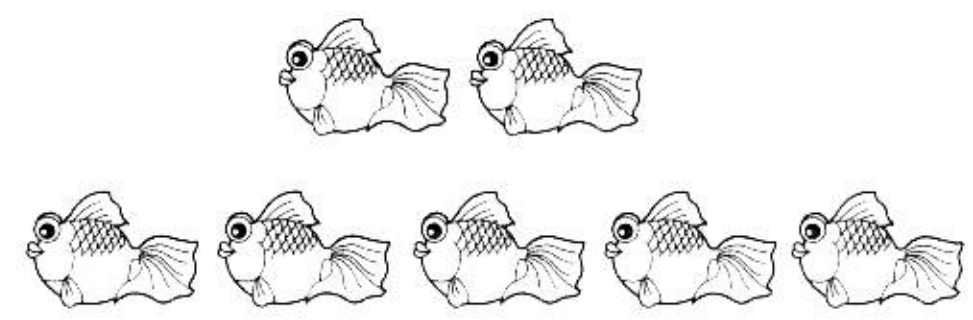

ဃ

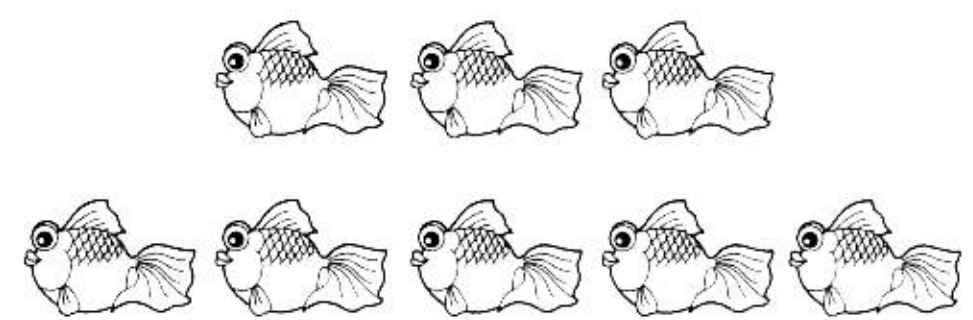

၇

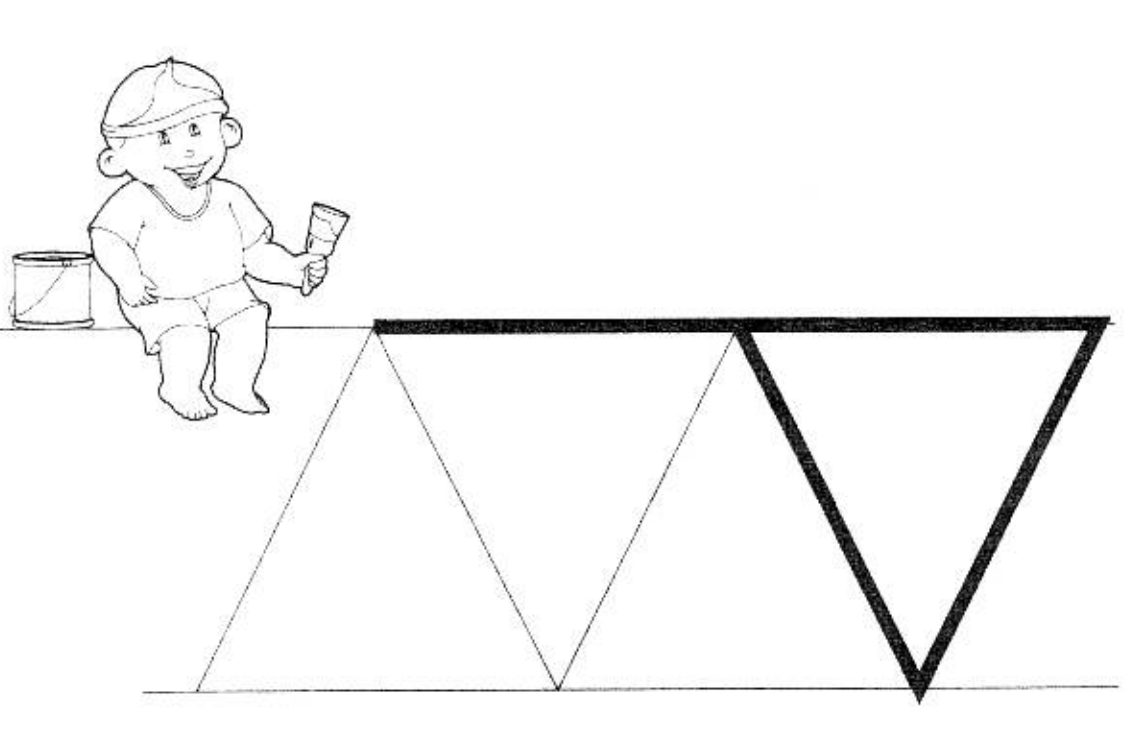
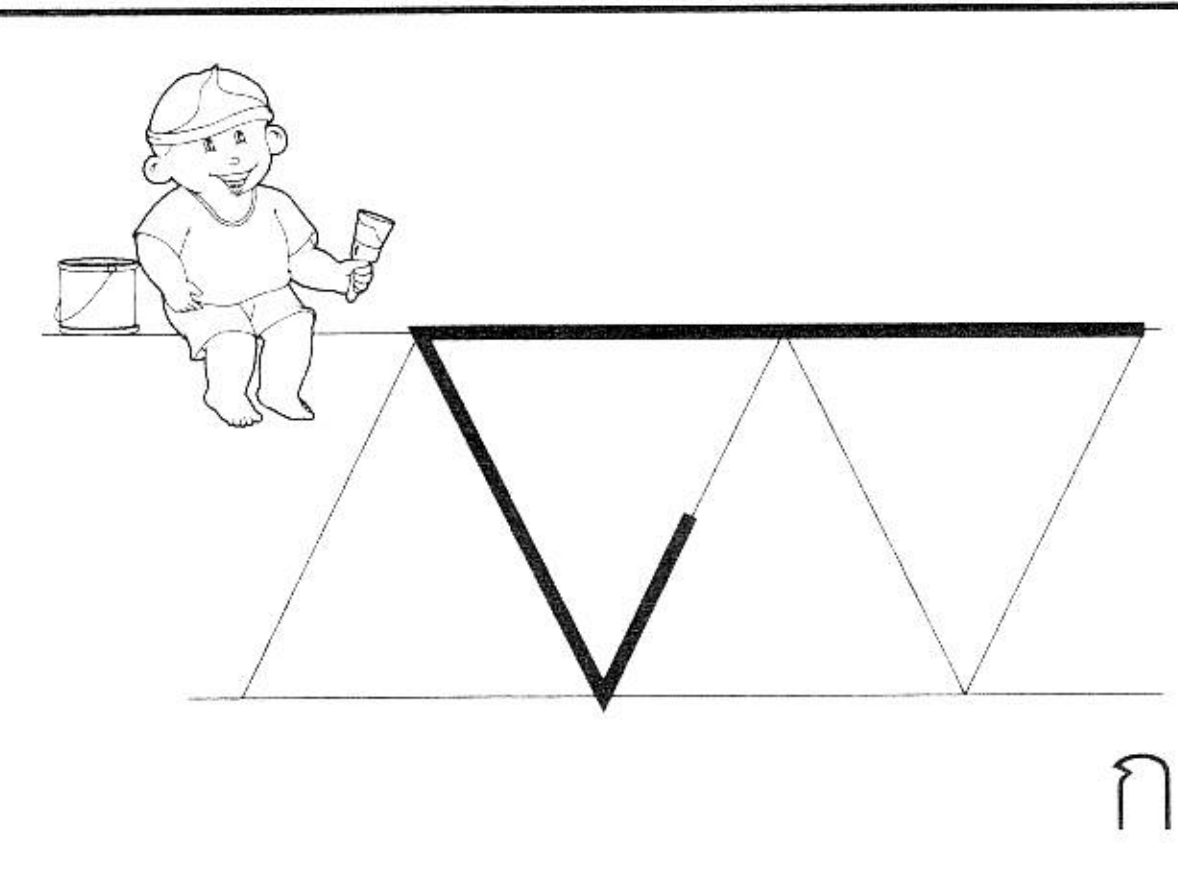
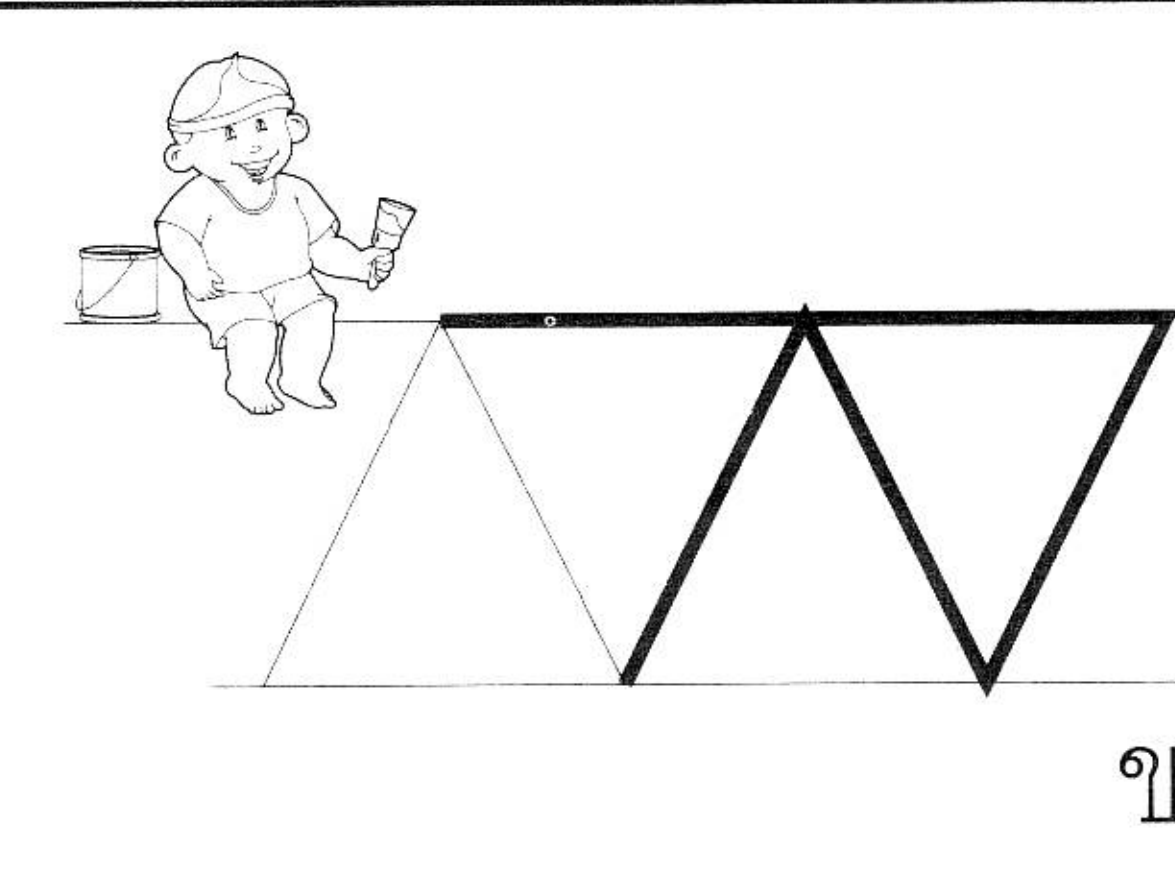
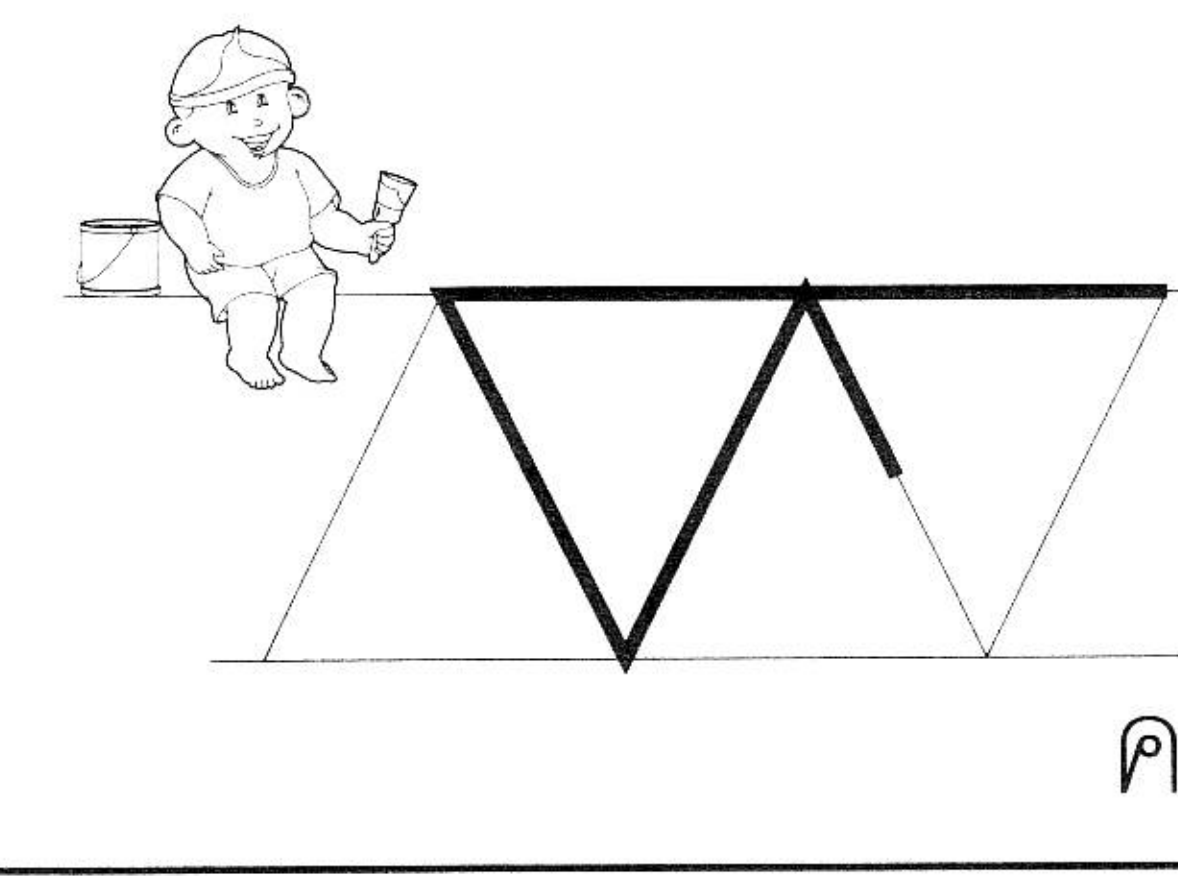
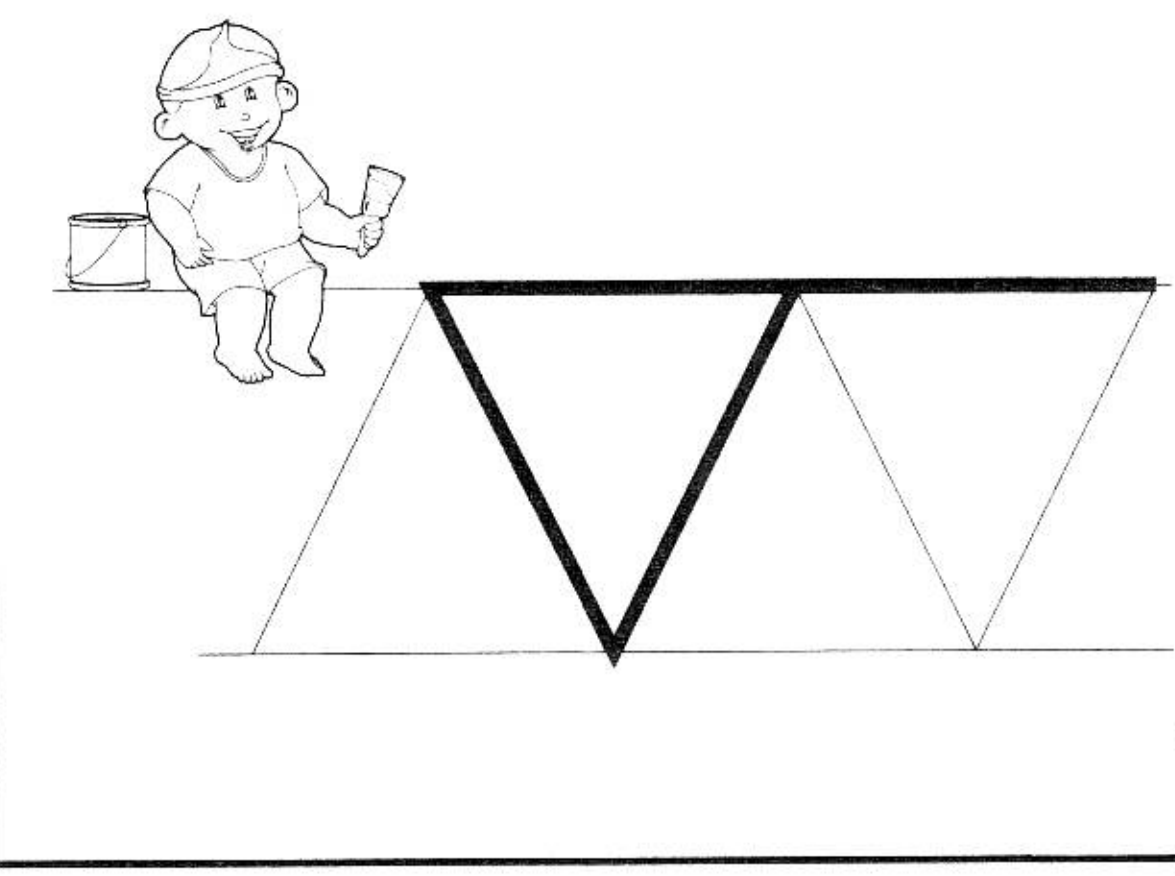

**4** คนงานในภาพโตทาสีราว สะพานได้ความยาวเท่ากับ ภาพแรก

ก ข  
ค ง

**5** คนงานกำลังเลื่อยไม้เป็น 4 ชิ้น ไม้ที่เลื่อยแล้วต่อได้ มีความยาวเท่ากับไม้ ในภาพแรก

ก ข  
ค ง

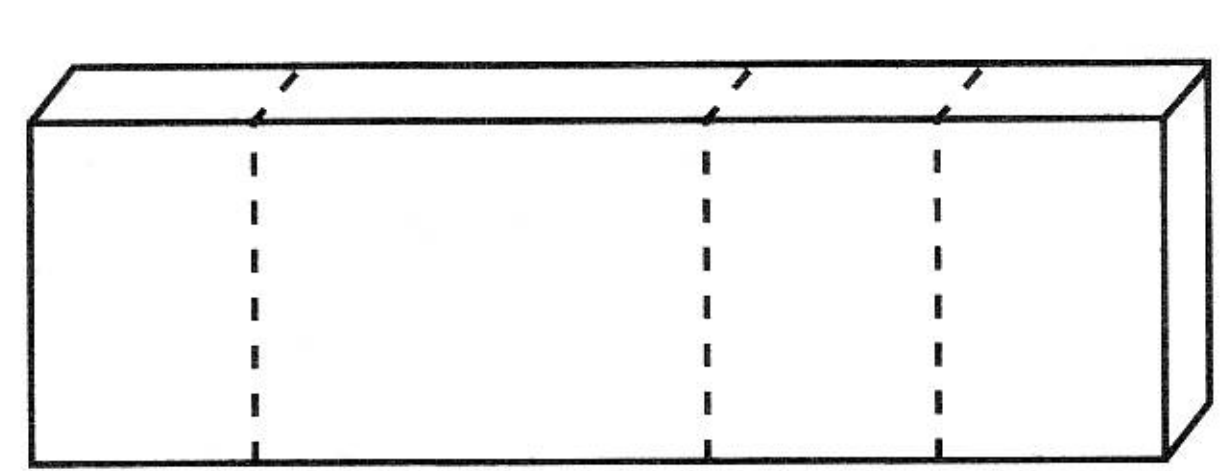
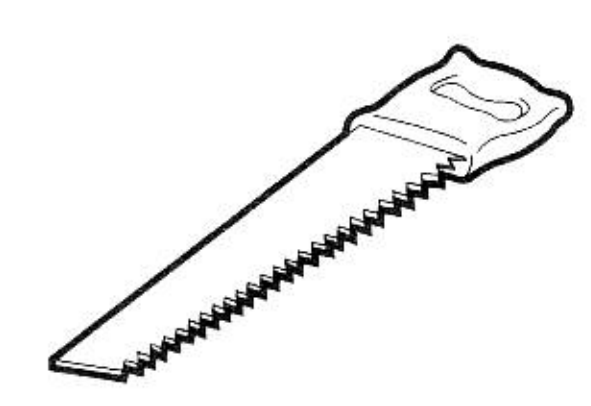
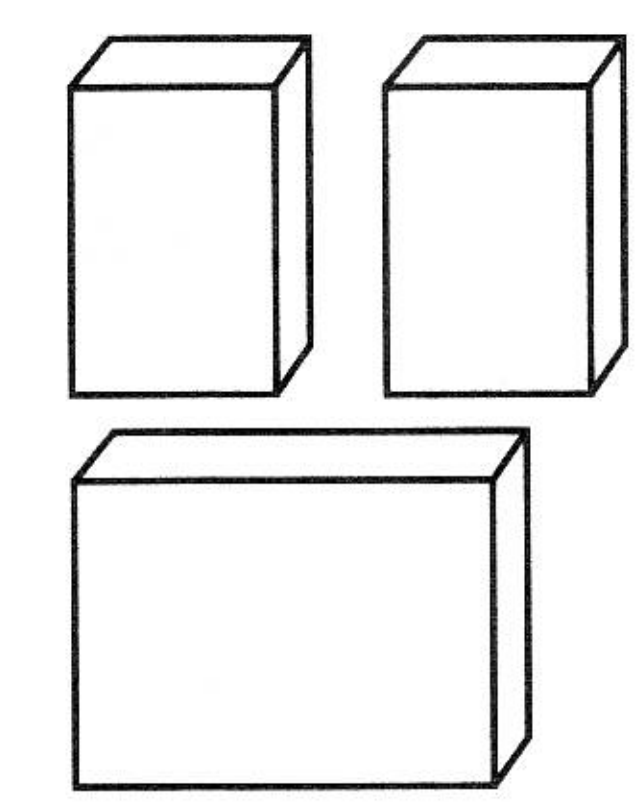
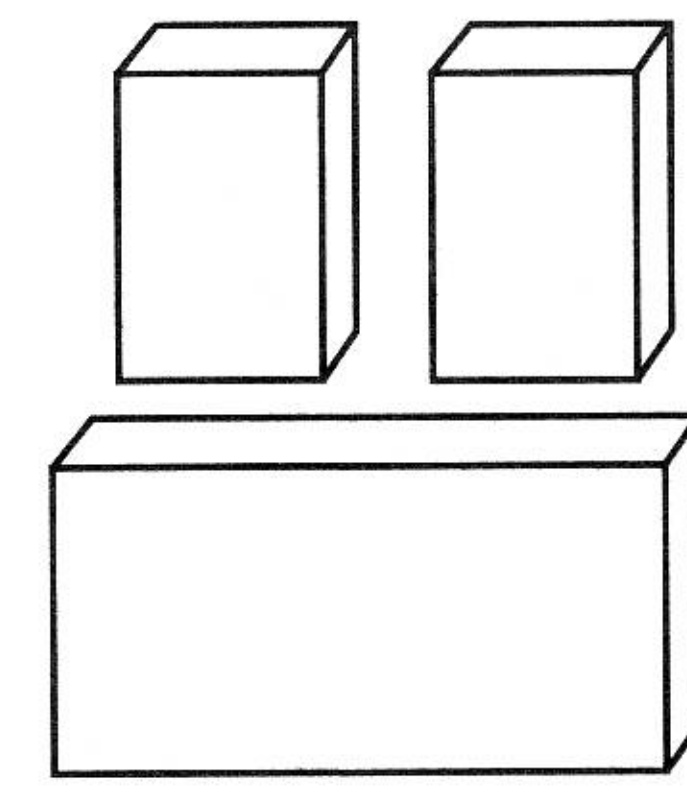
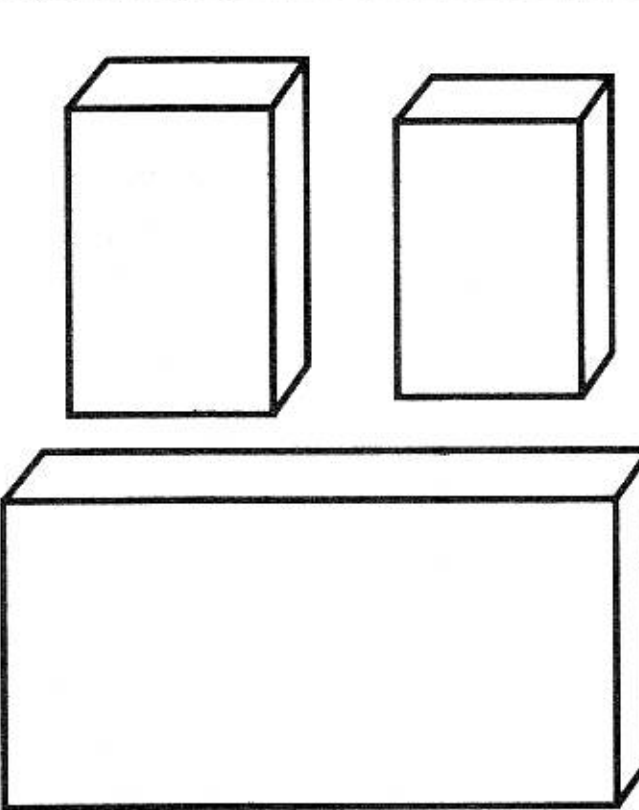
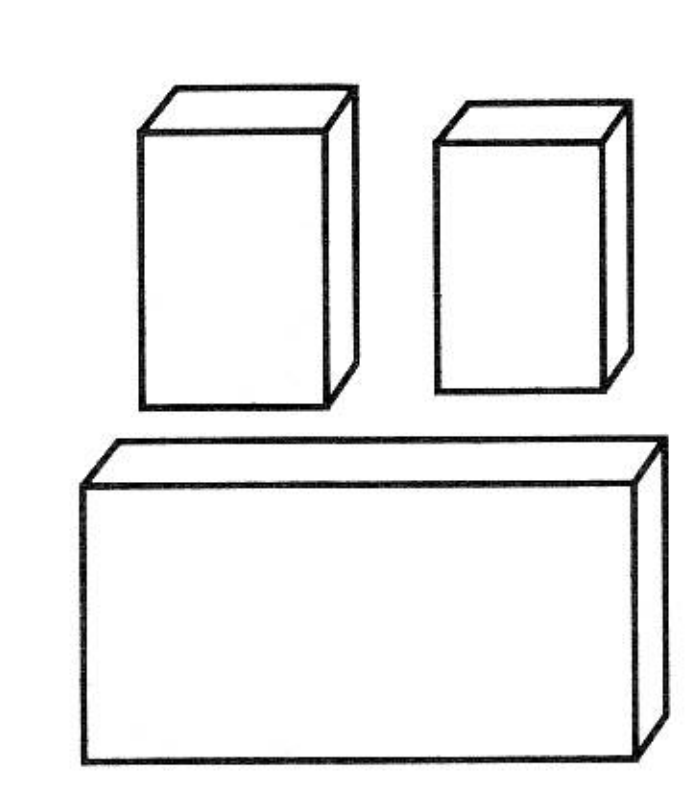
**6** ให้หาผ้าที่มีความยาว เพียงพอที่จะทำม่าน ให้หน้าต่าง 3 บานนี้



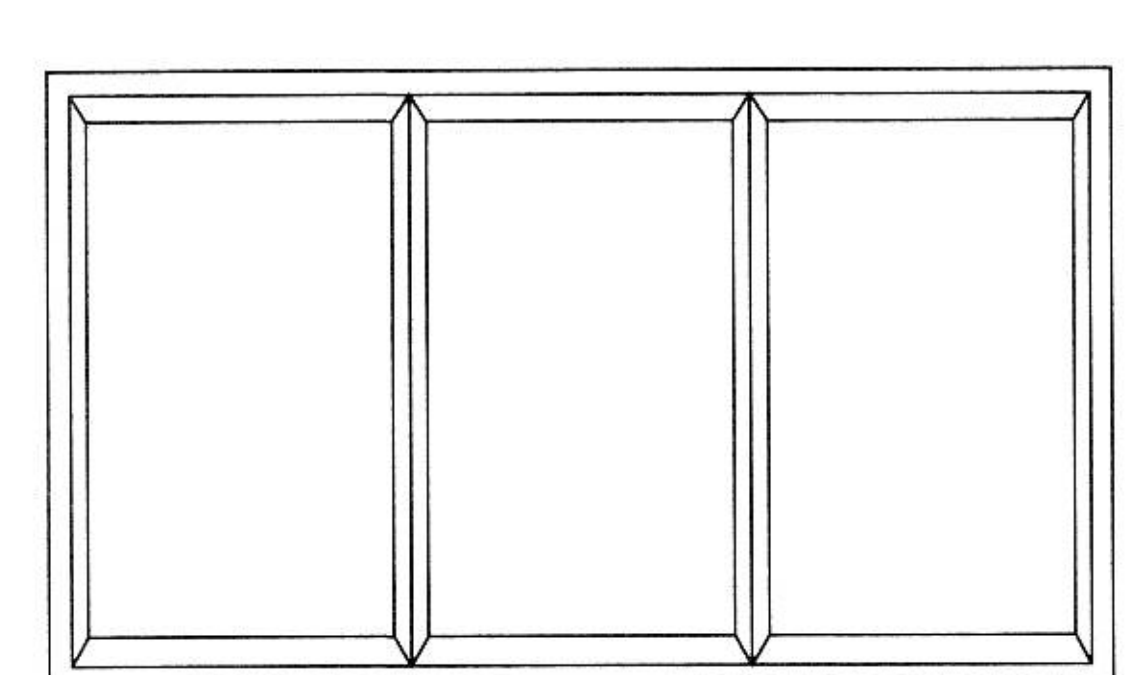
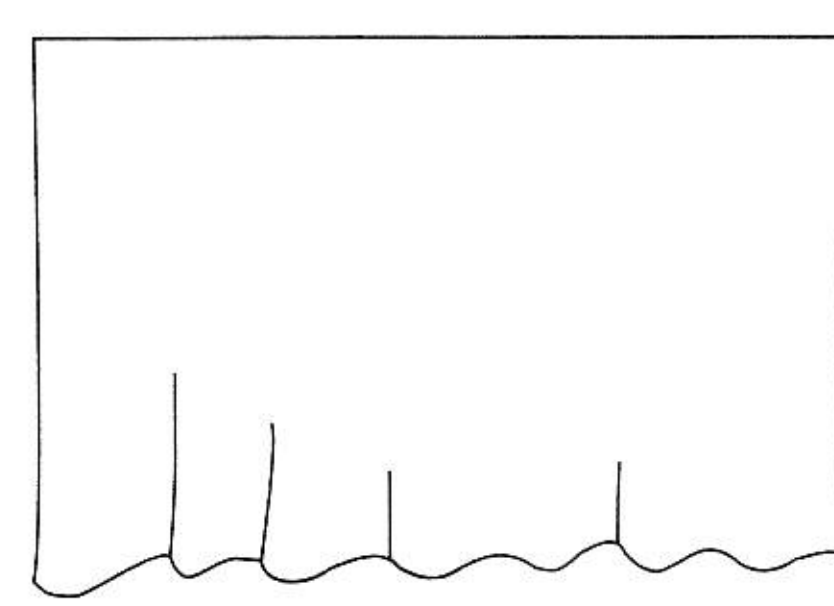
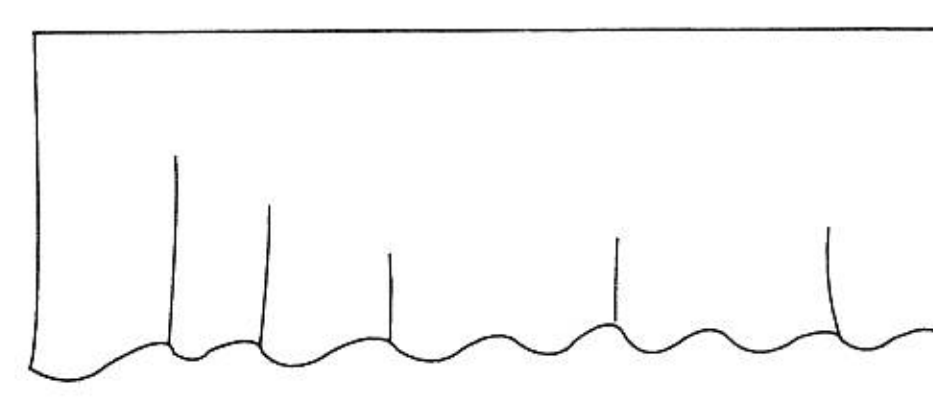
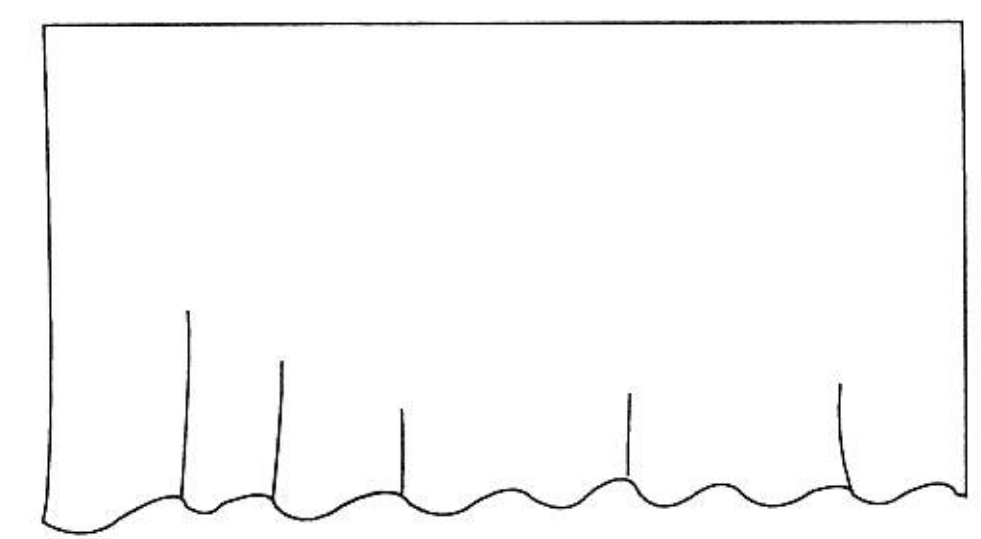
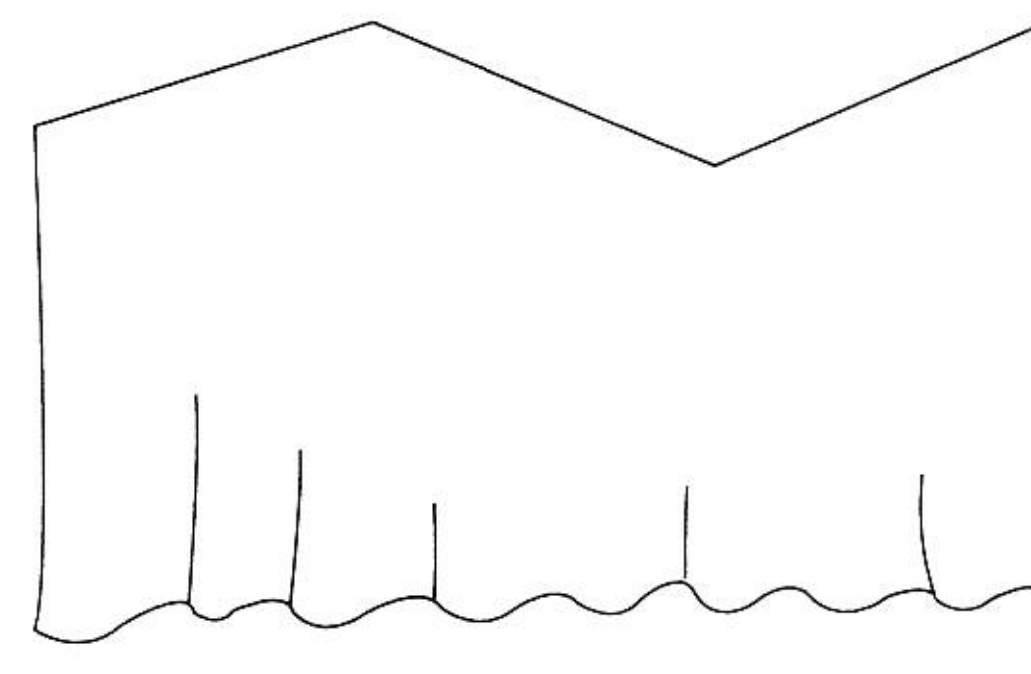



ก ข  
ค ง

7 สร้อยเส้นใดมีความยาว  
รวมแล้วเท่ากับสร้อย  
ในภาพแรก

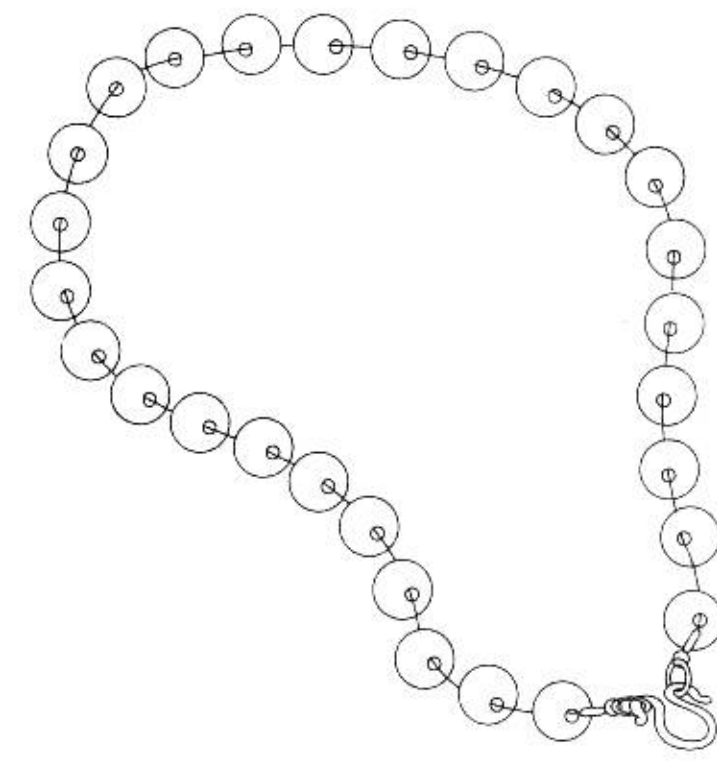

ก



ข

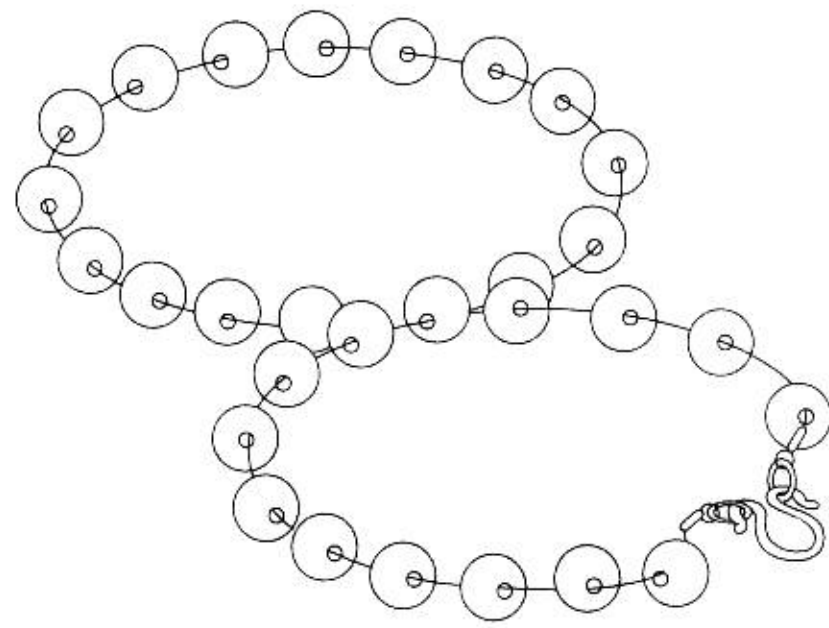

ค

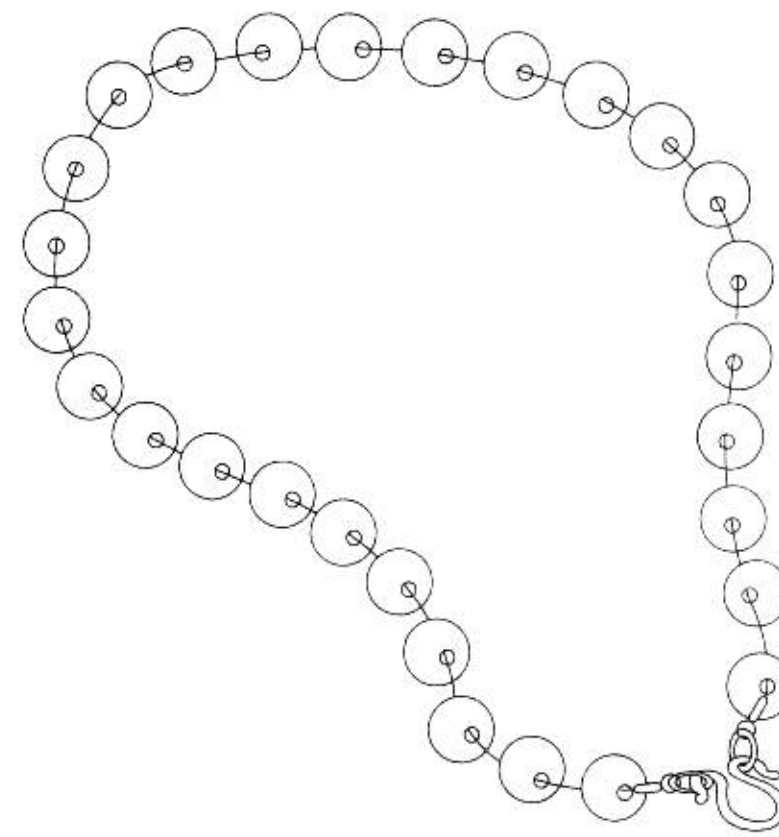

ง

8 เชือกเส้นใดมีความยาว  
พอที่จะนำมาขดทับ  
ภาพแรกได้พอดี

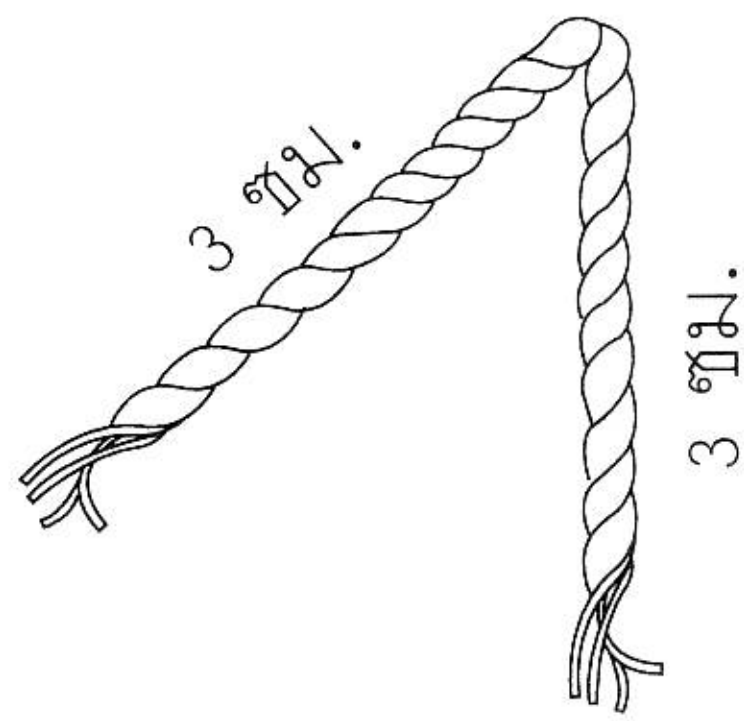
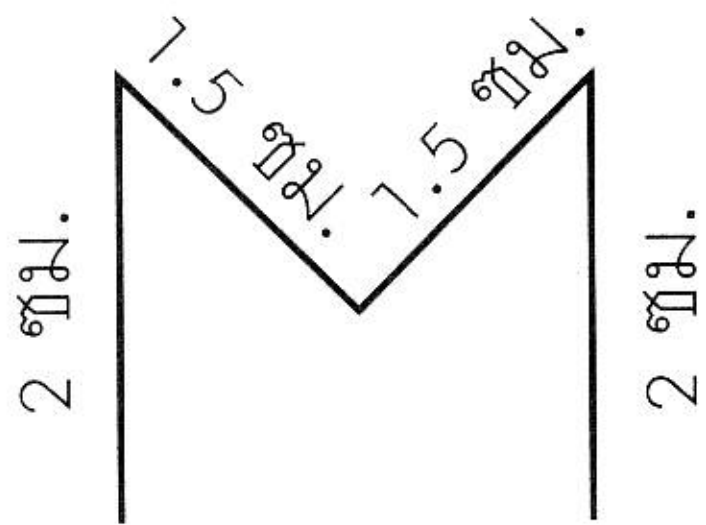

ก

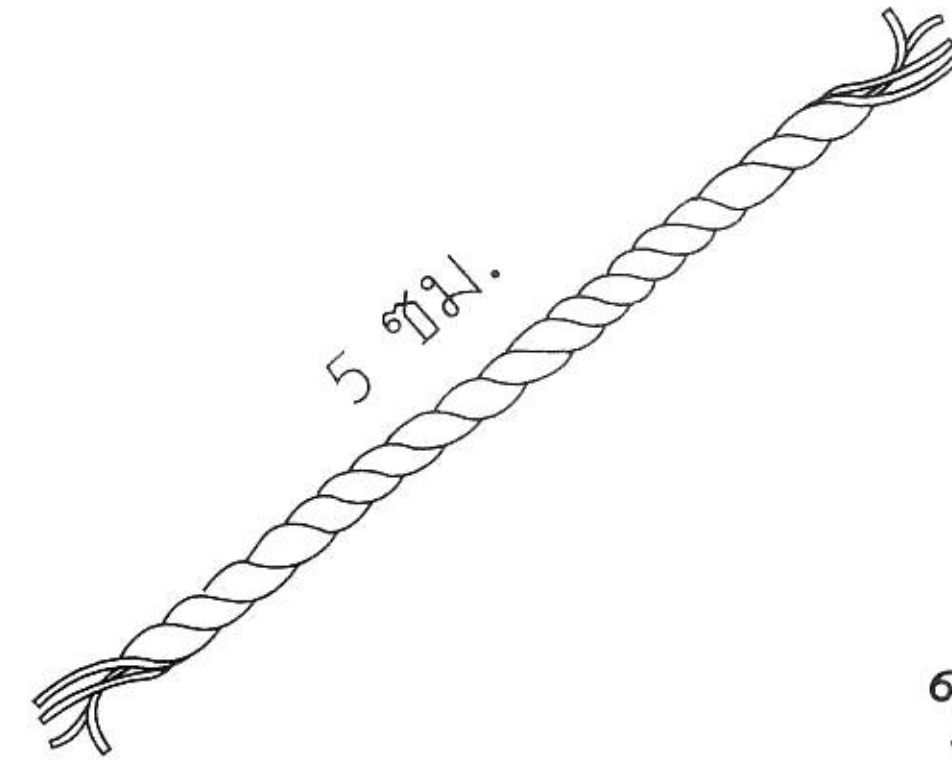

ข

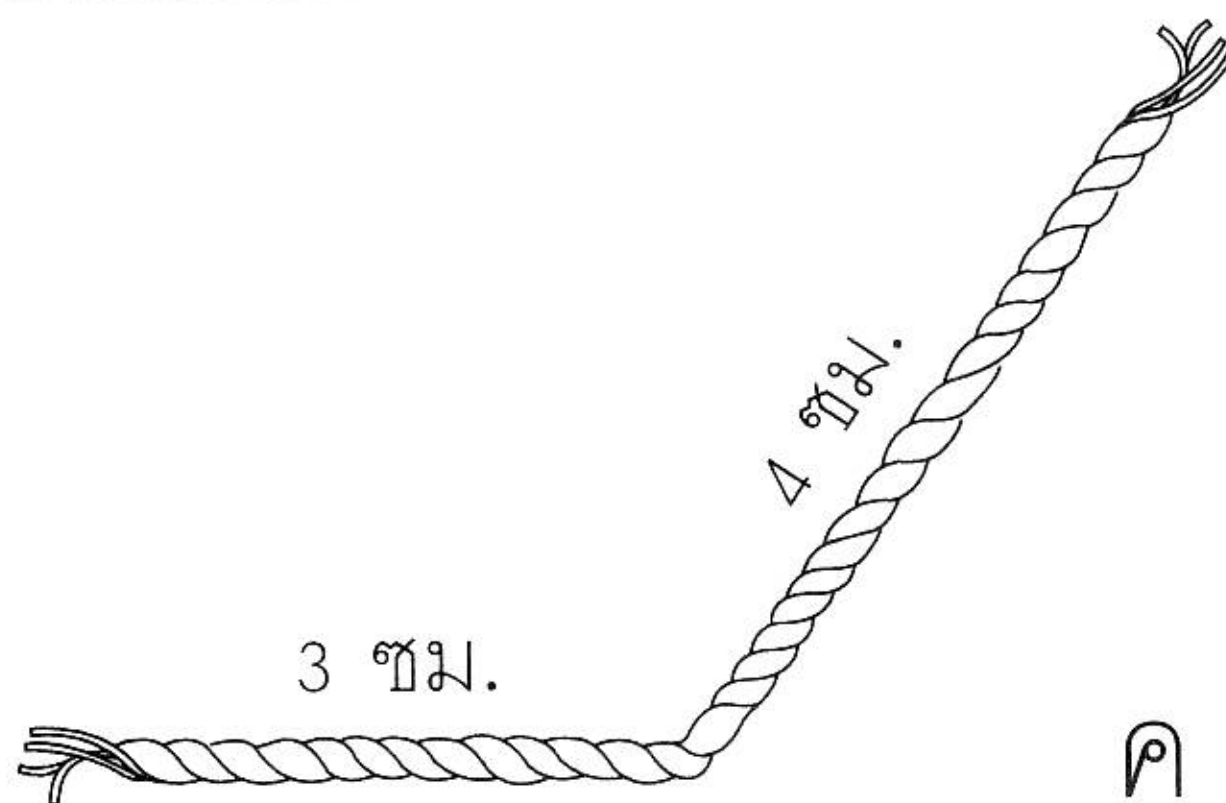

ค

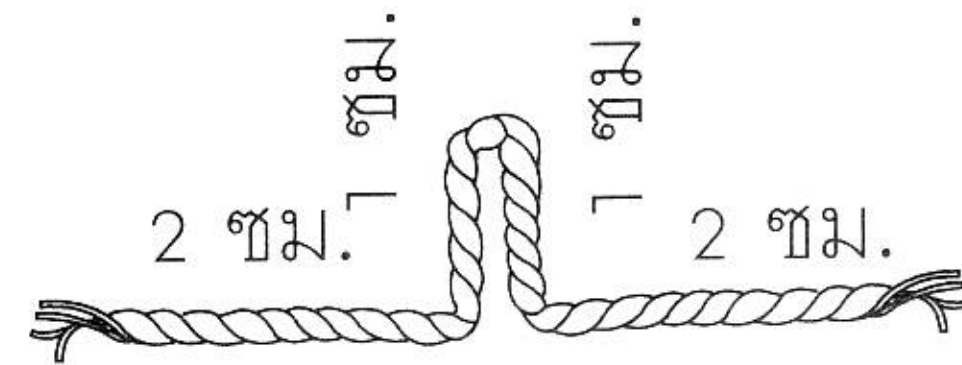

ง

9 กล่องใบใดที่มีความกว้างและ  
ความยาวพอที่จะใส่ขนมปัง  
แถวนี้ได้

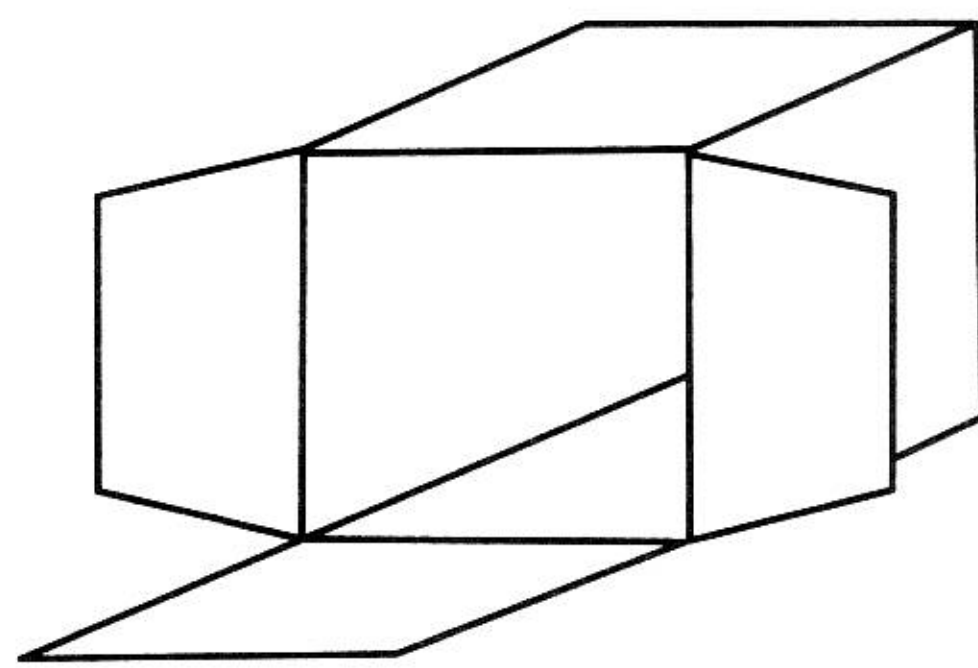
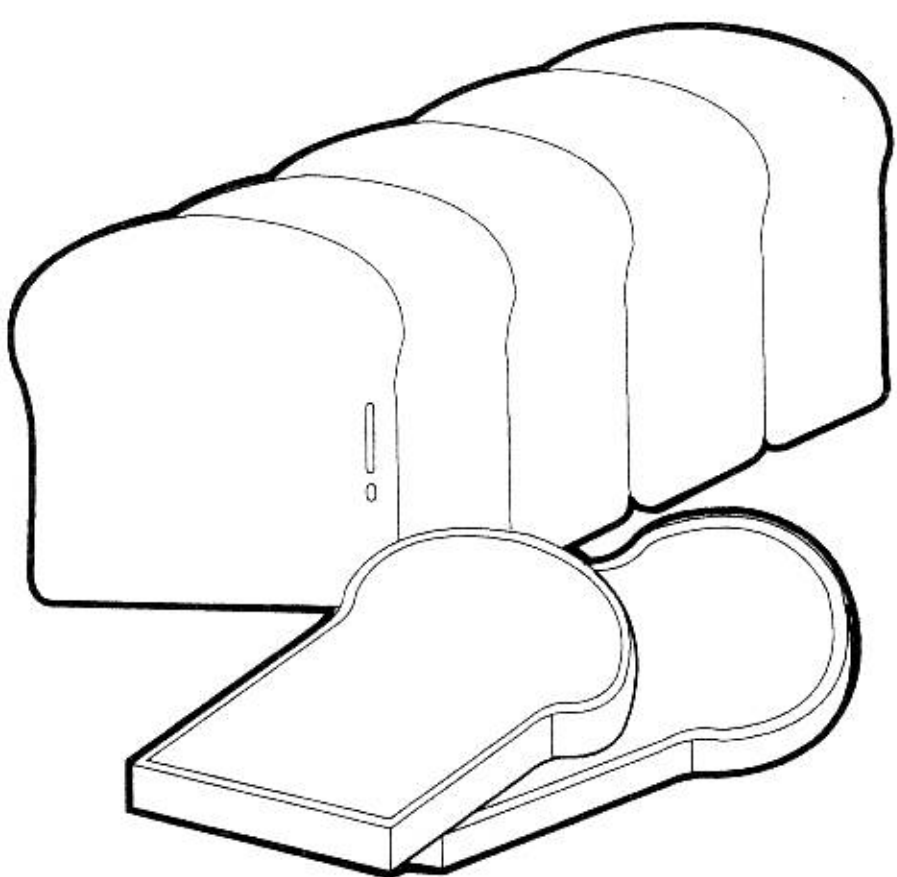

ก

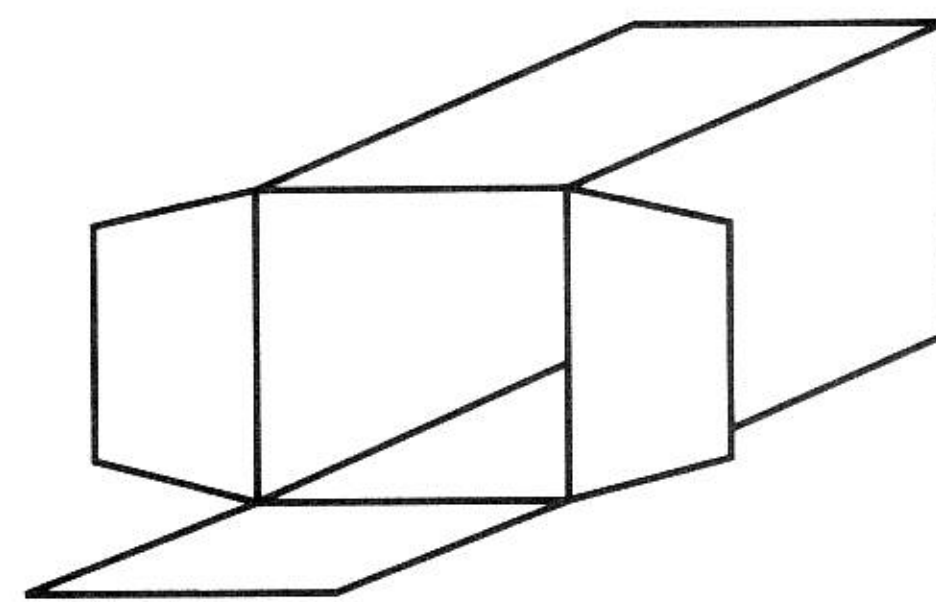

ข

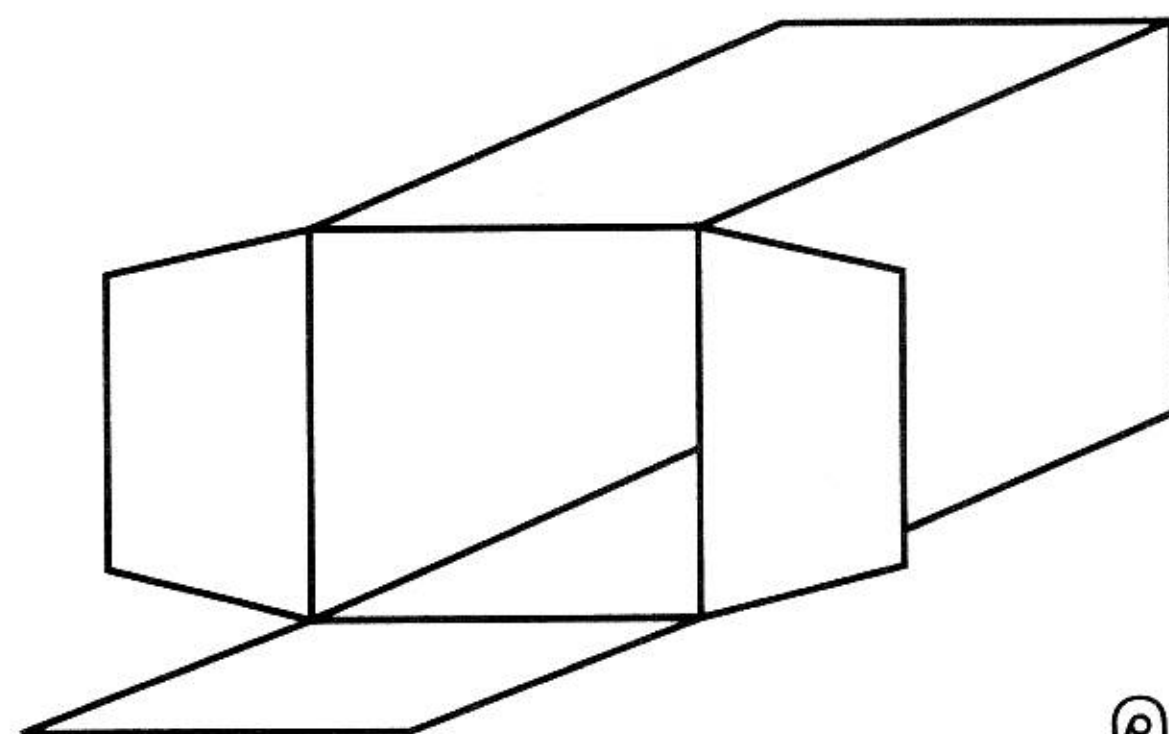

ค

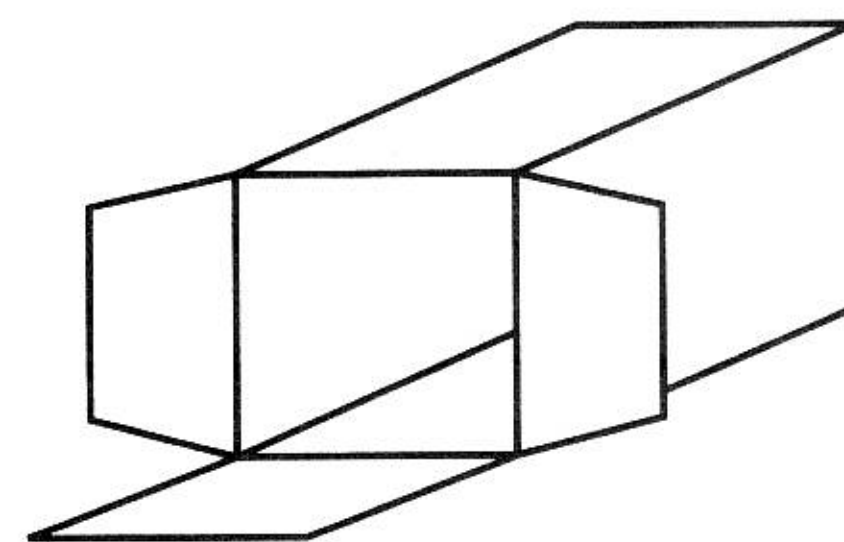

ง

10 ดินสอในภาพใดที่นำมา  
ต่อกันแล้วมีความยาว  
เท่ากับดินสอในภาพแรก

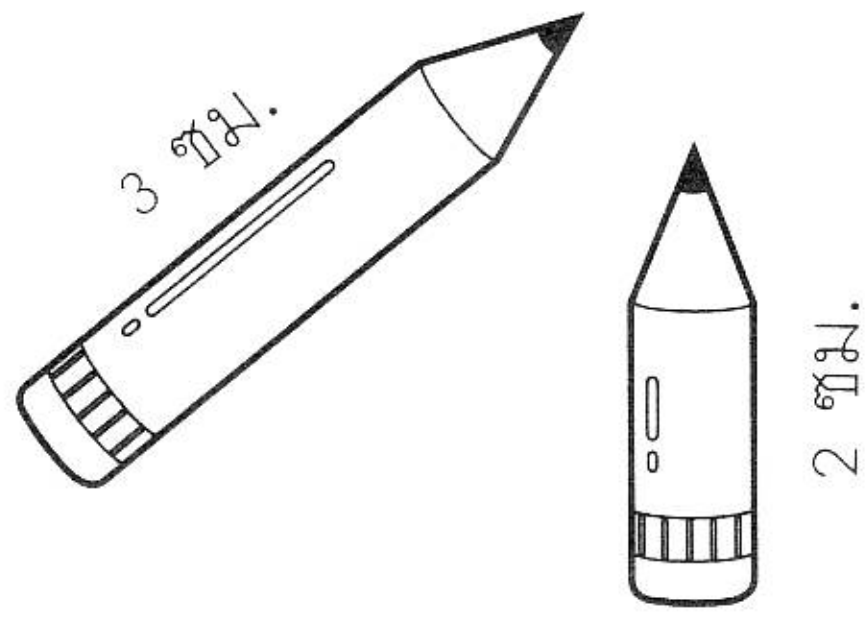
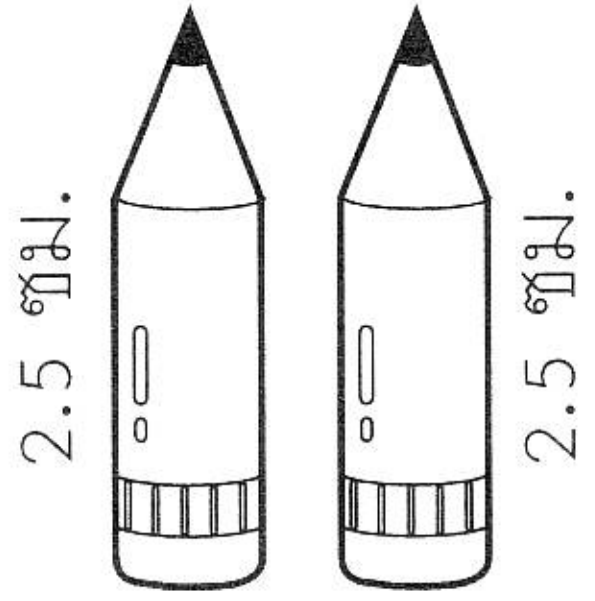

ก

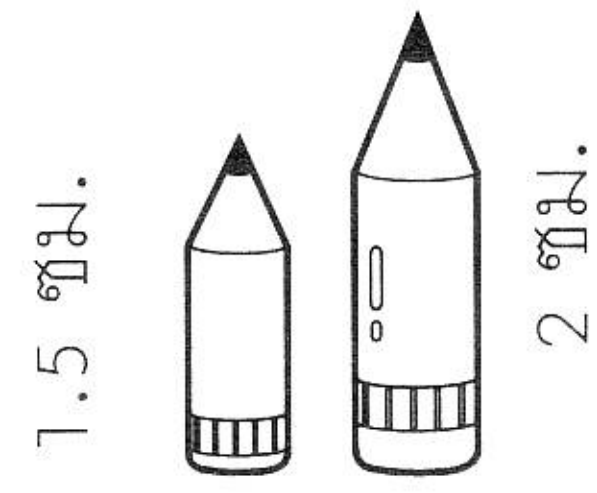

ข

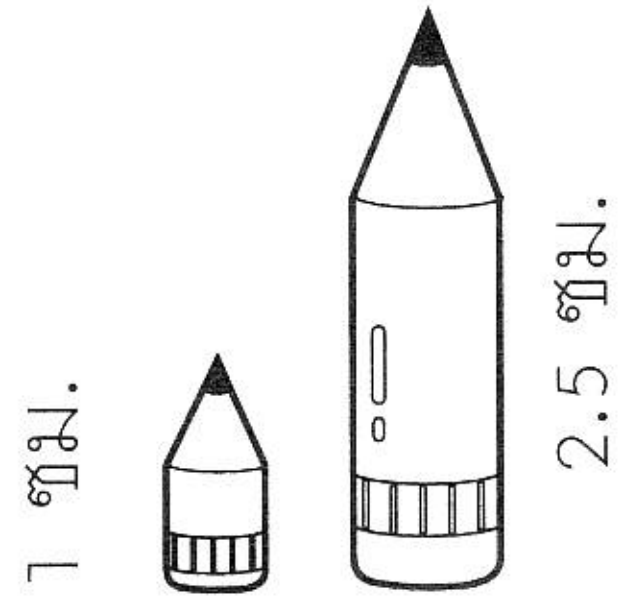

ค

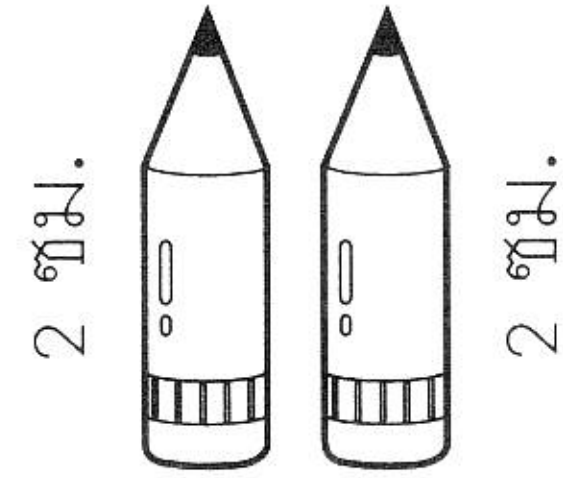

ง

11 ใครที่วิ่งได้ระยะทางเท่ากัน

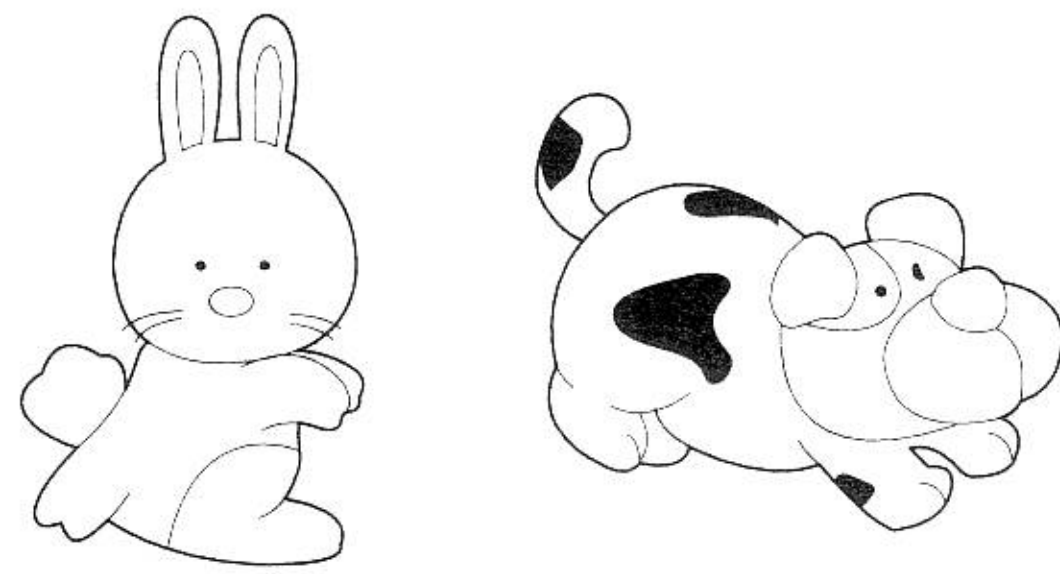
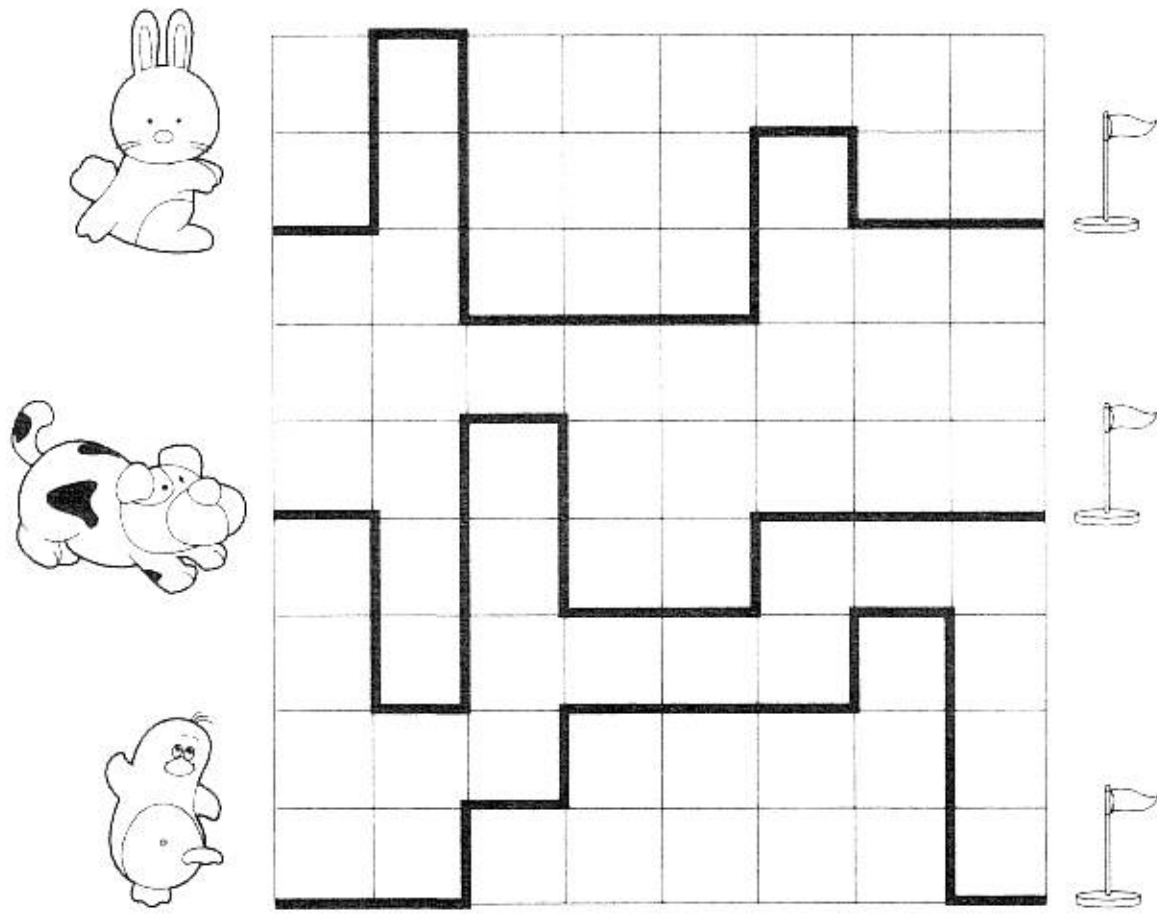

ก

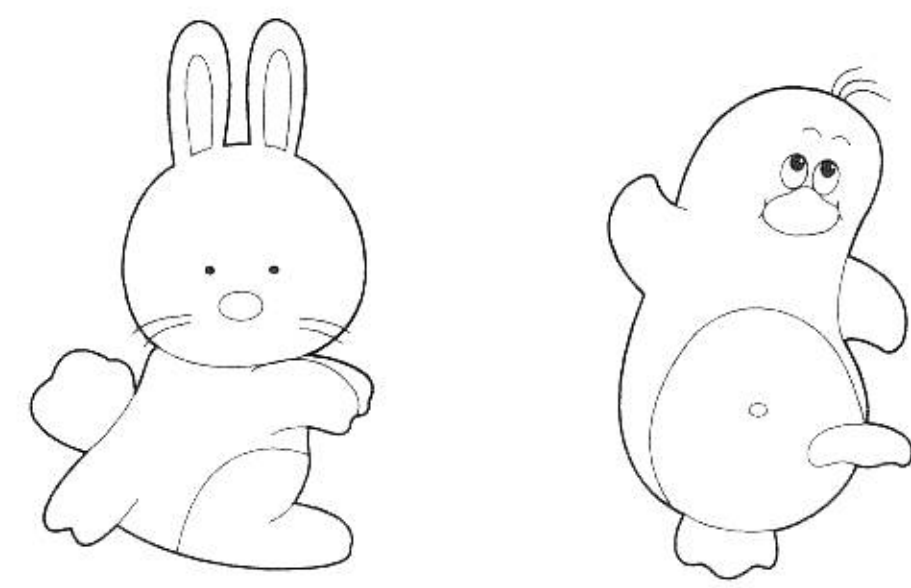

ข

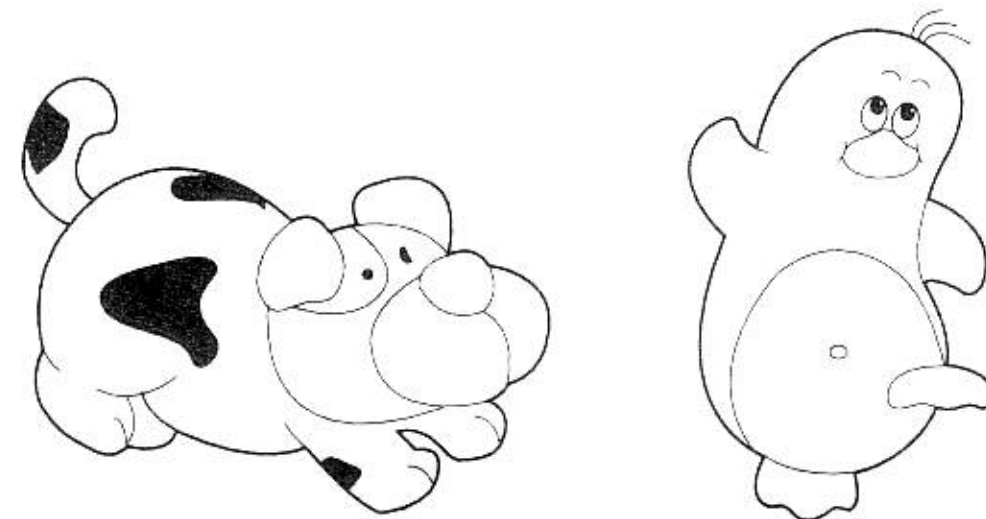

ค

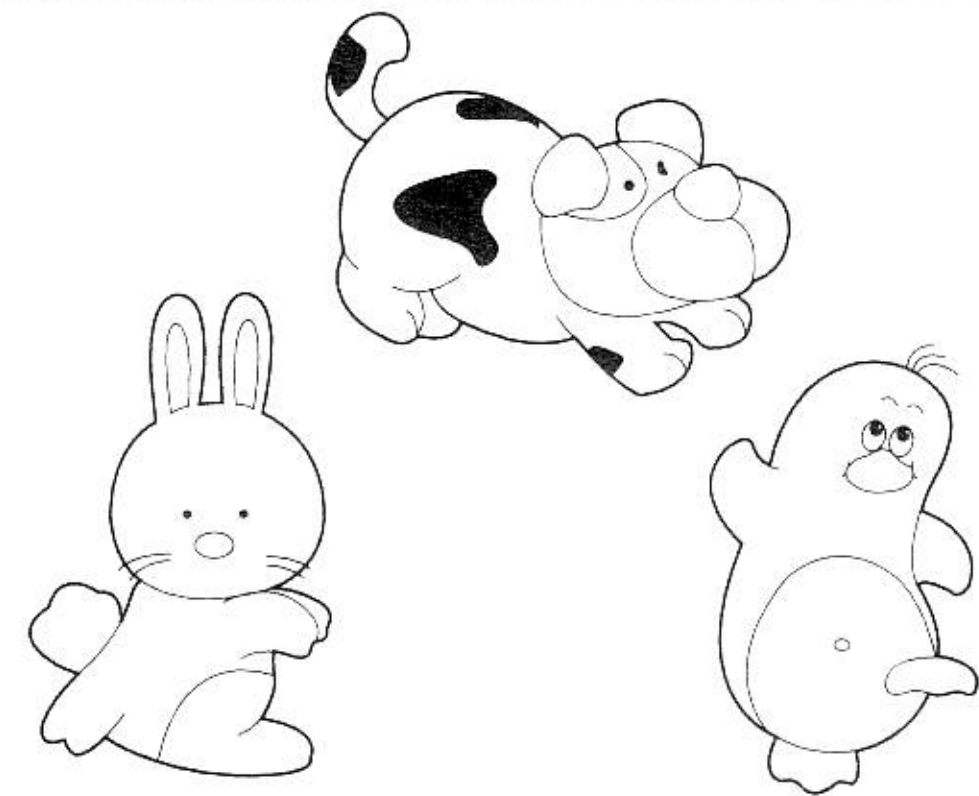

ง

12 ภาพใดพายเรือได้ระยะทาง  
เท่ากับภาพแรก

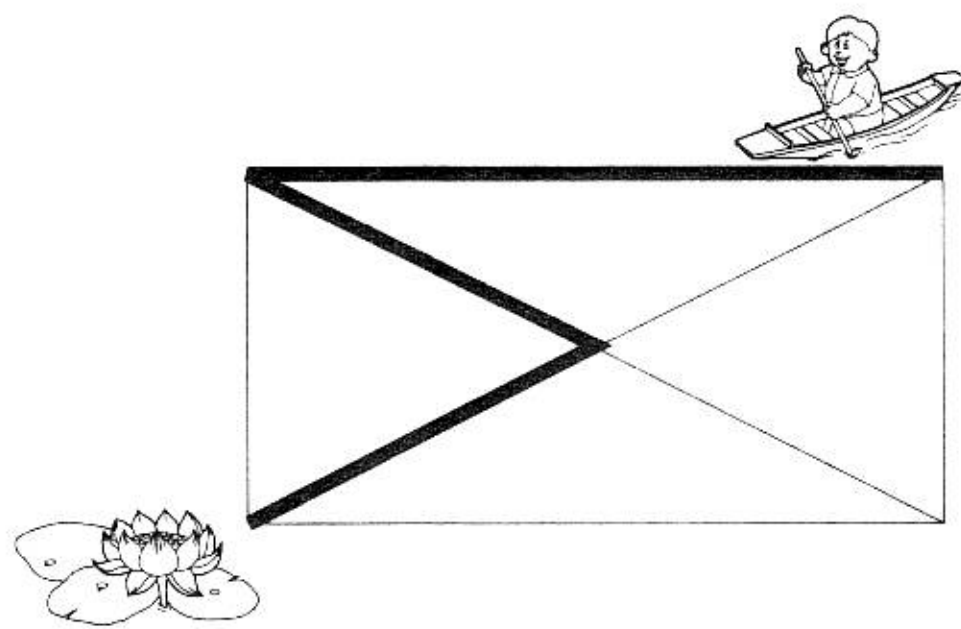
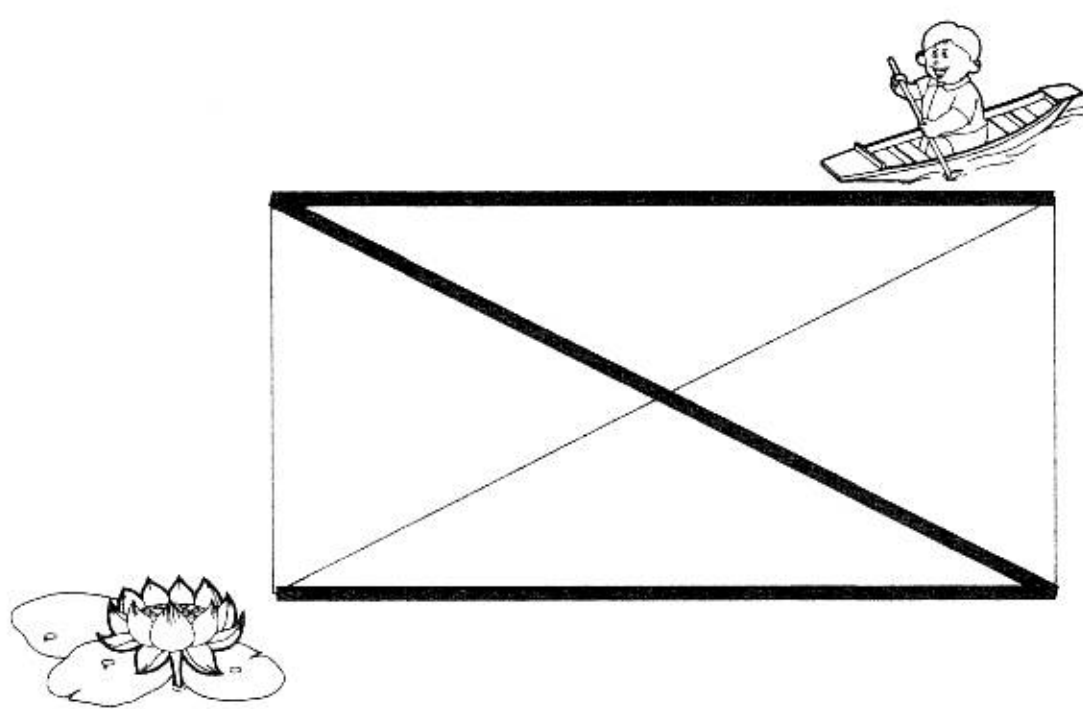

ก

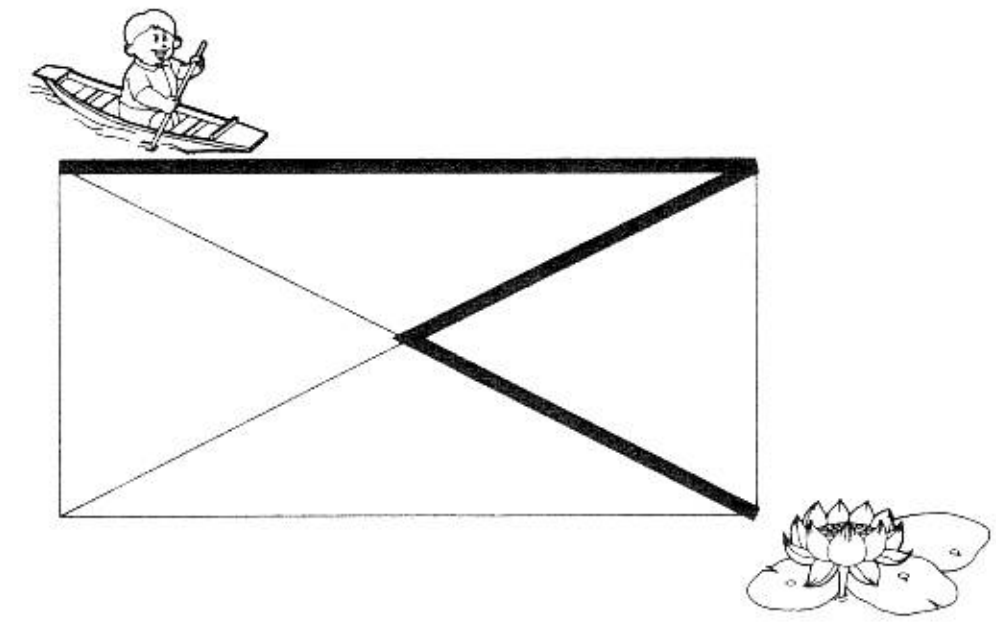

ข

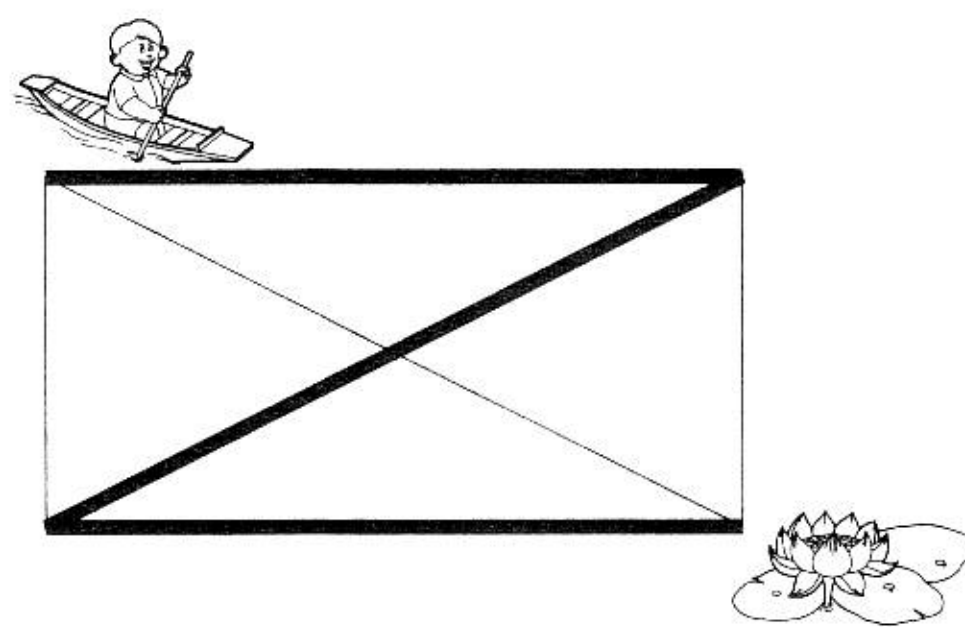

ค

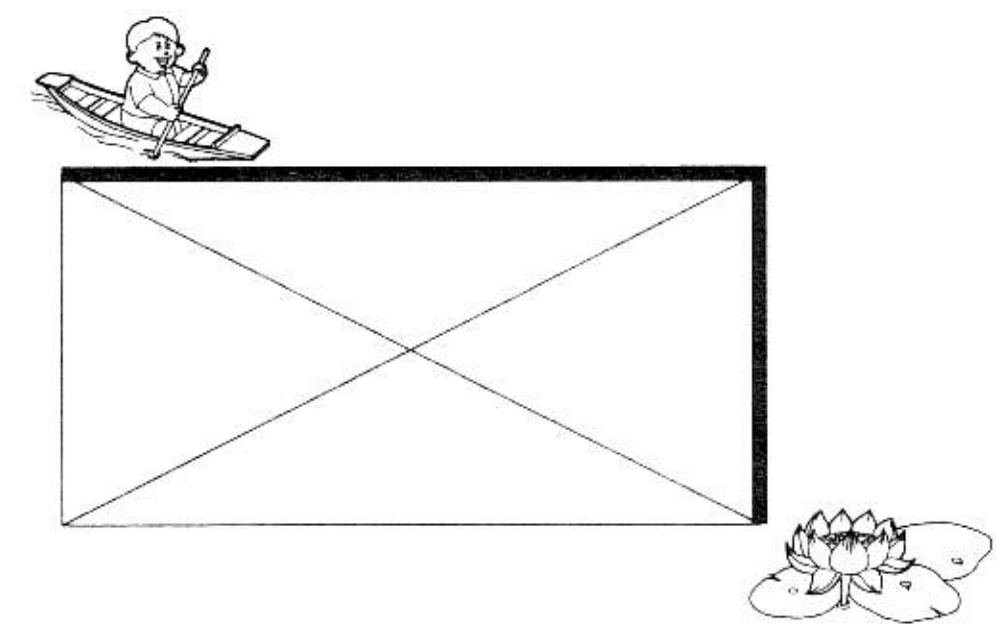

ง

13 กบตัวโตกระโดดขึ้นเนิน  
ได้ระยะทางเท่ากับกบ  
ในภาพแรก

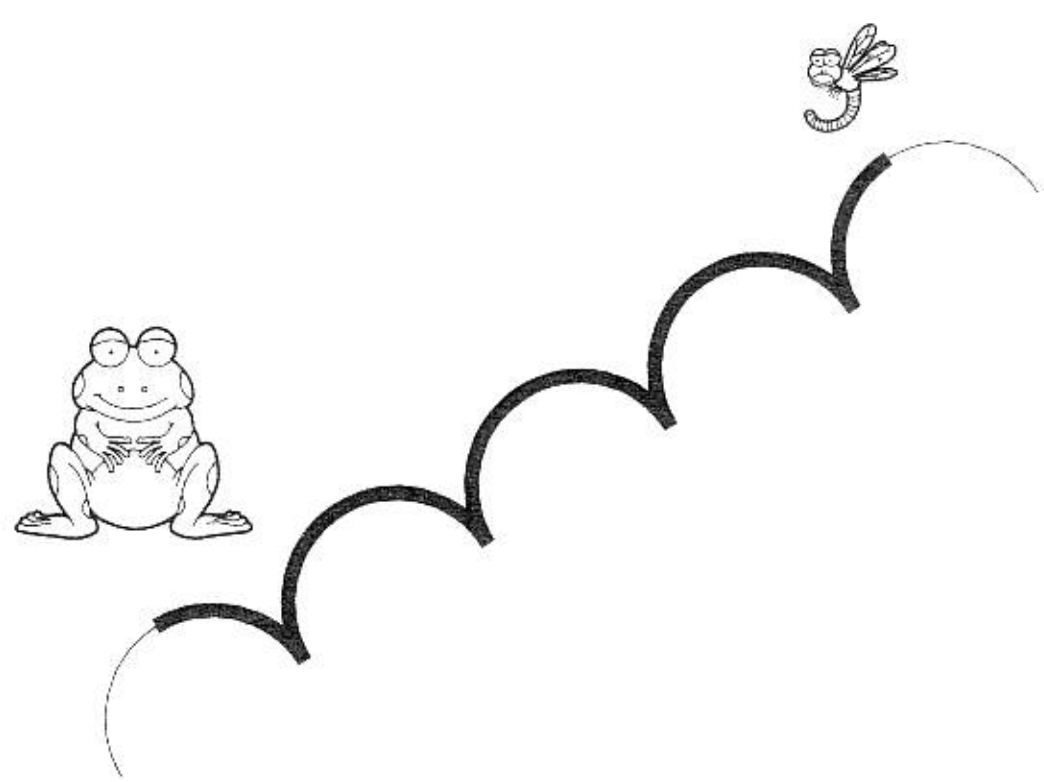
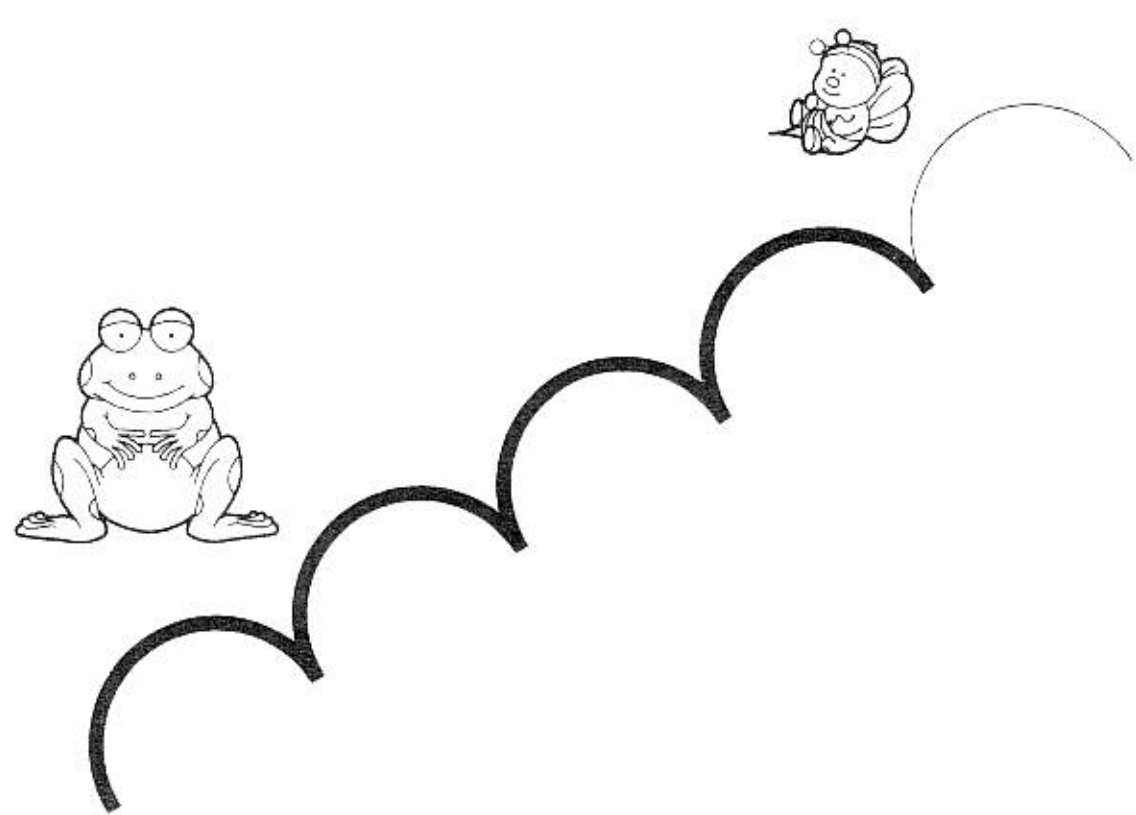

ก

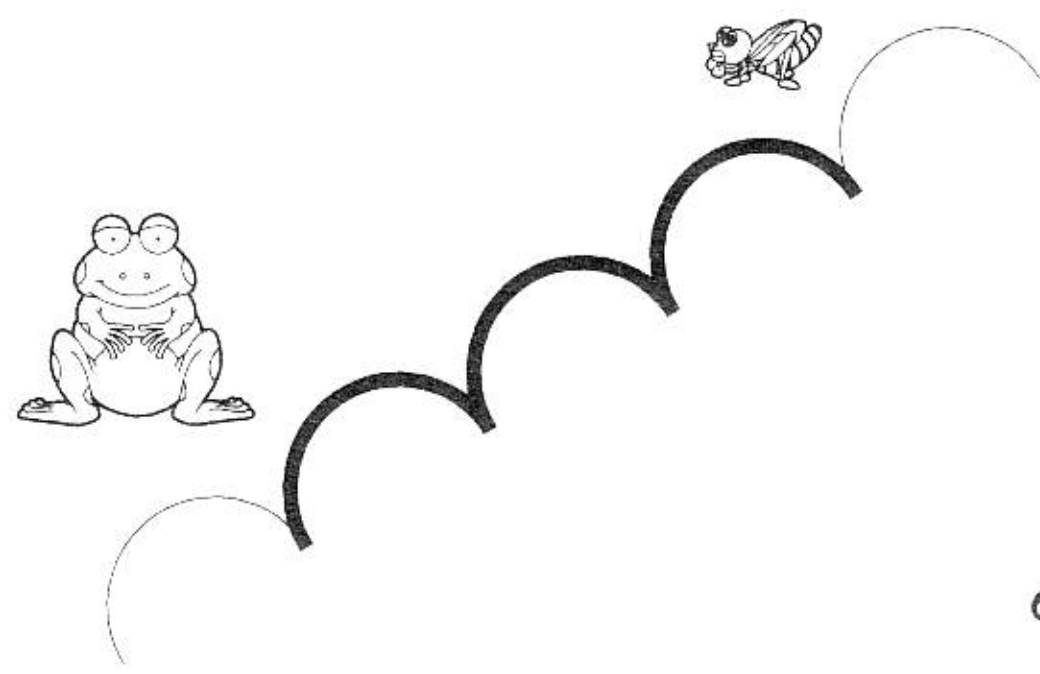

ข

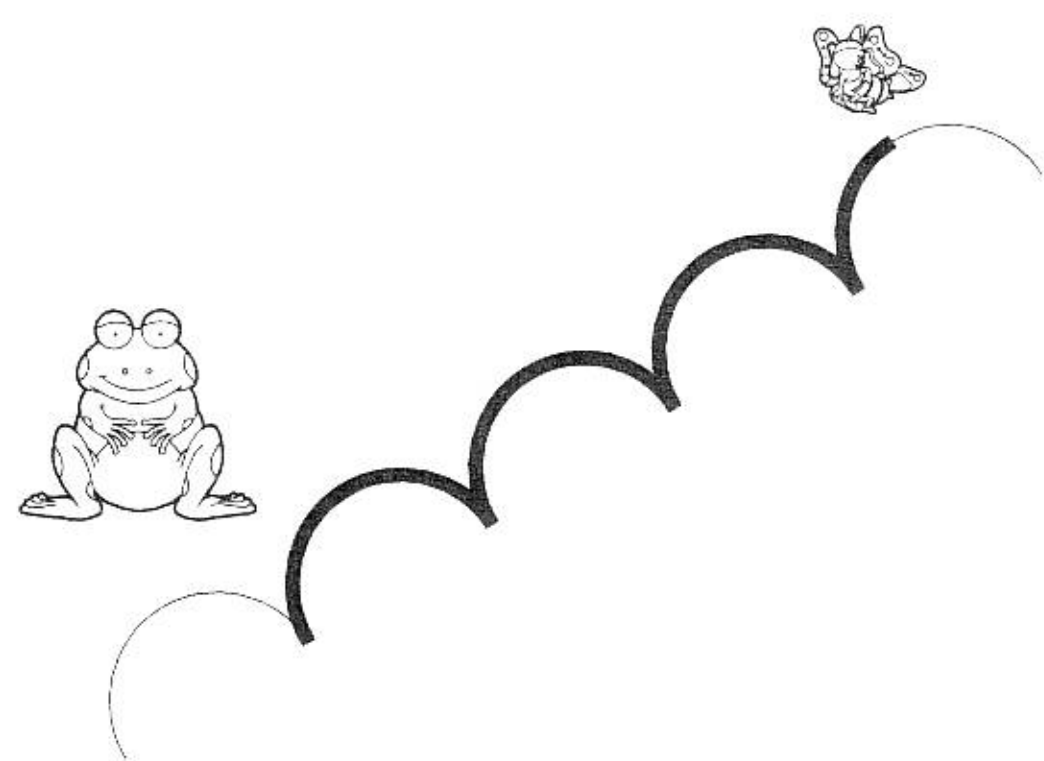

ค

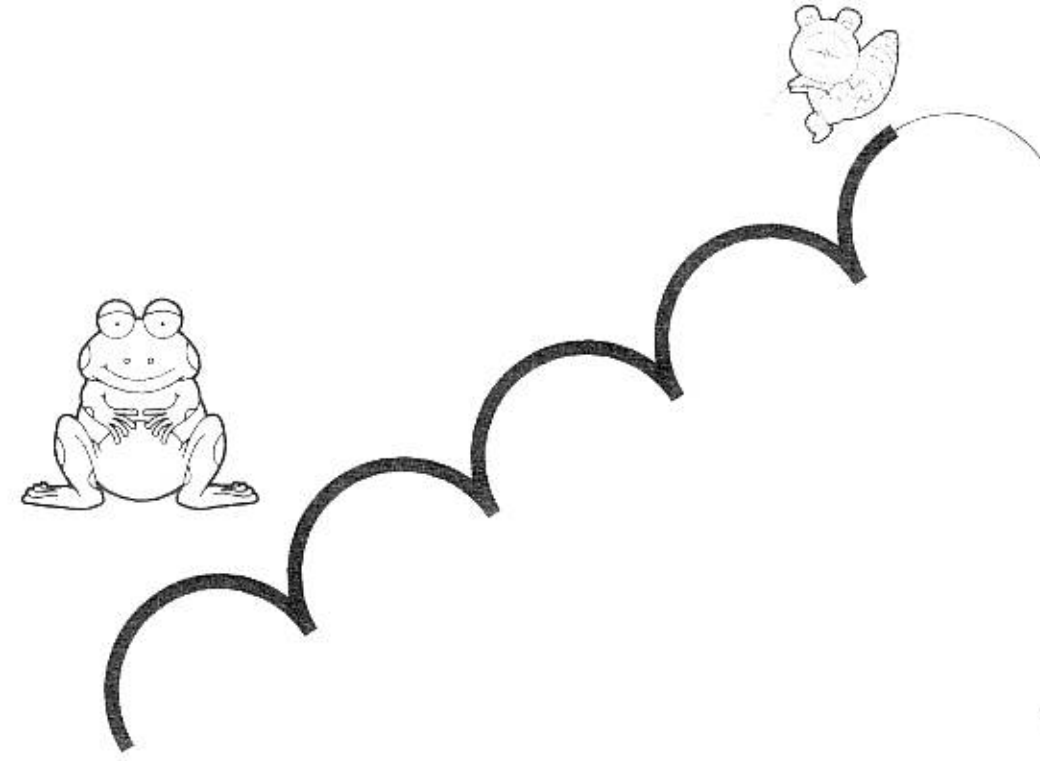

ง

14 เครื่องบินในภาพใดบินได้  
ระยะทางยาวเท่ากับ  
เครื่องบินในภาพแรก

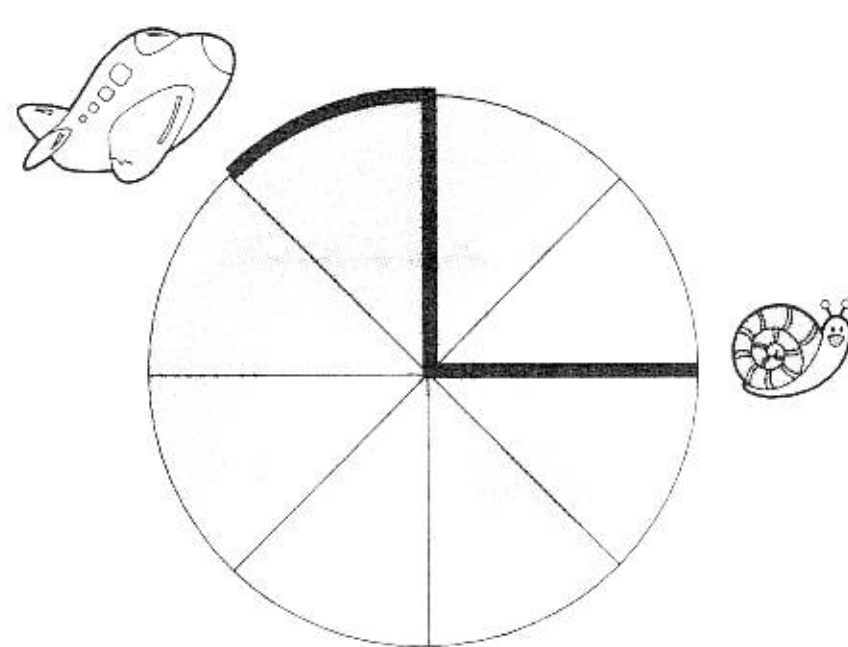
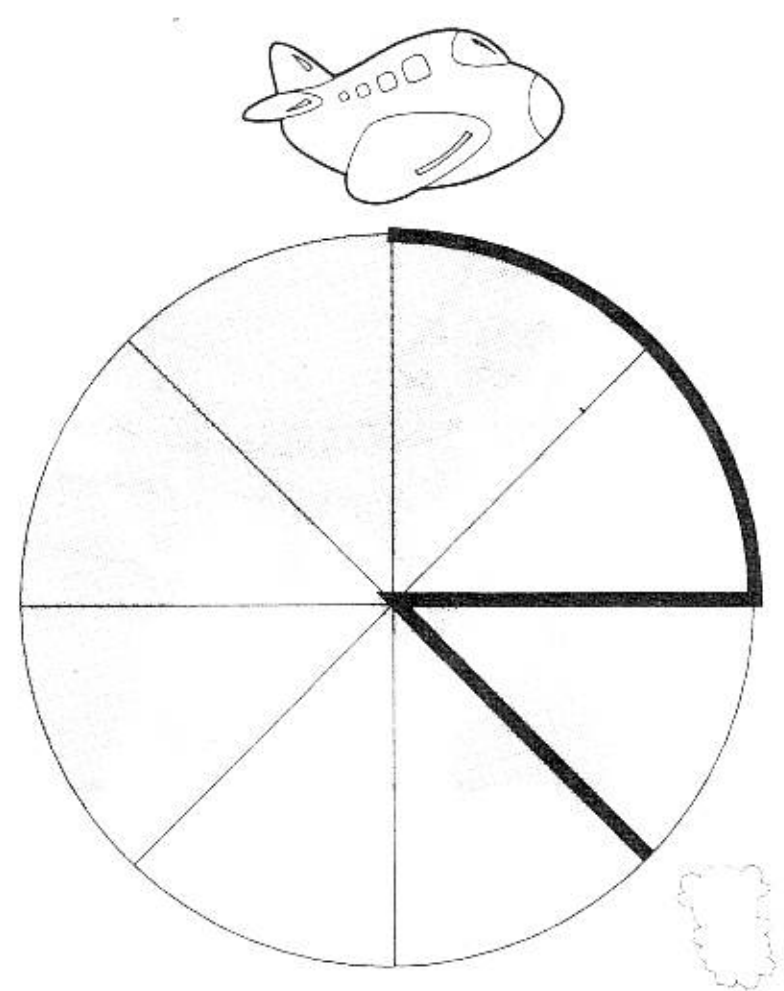

ก

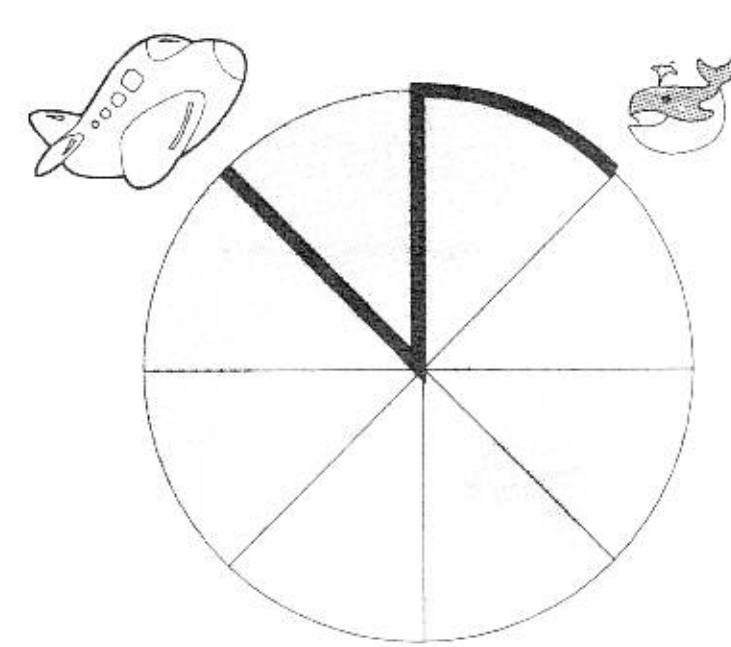

ข

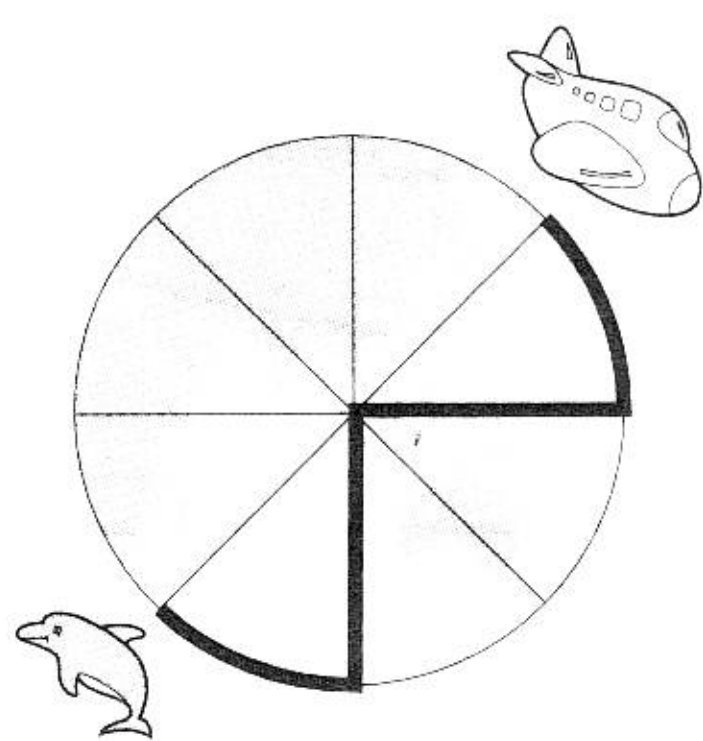

ค

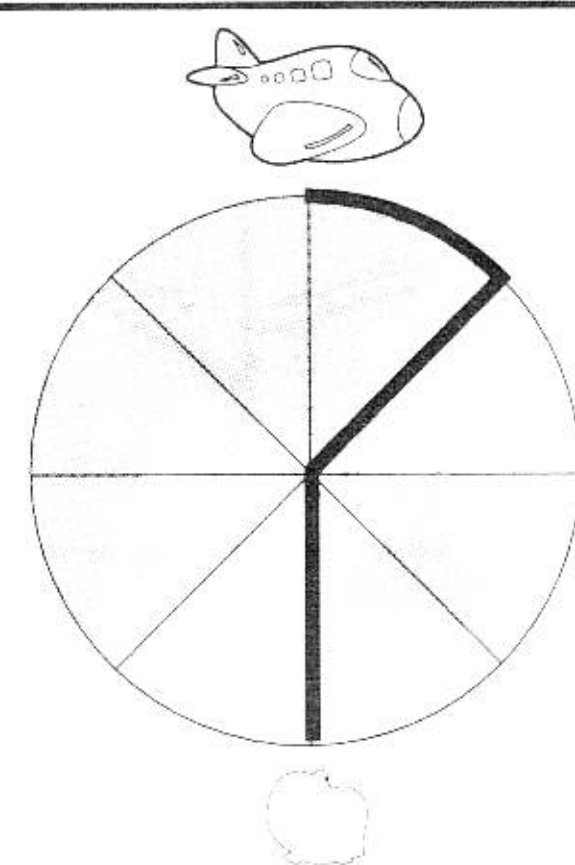

ง

15 ที่คั่นหนังสือในภาพใด  
เมื่อนำมาต่อกันแล้วจะมี  
ความยาวเท่ากับภาพแรก

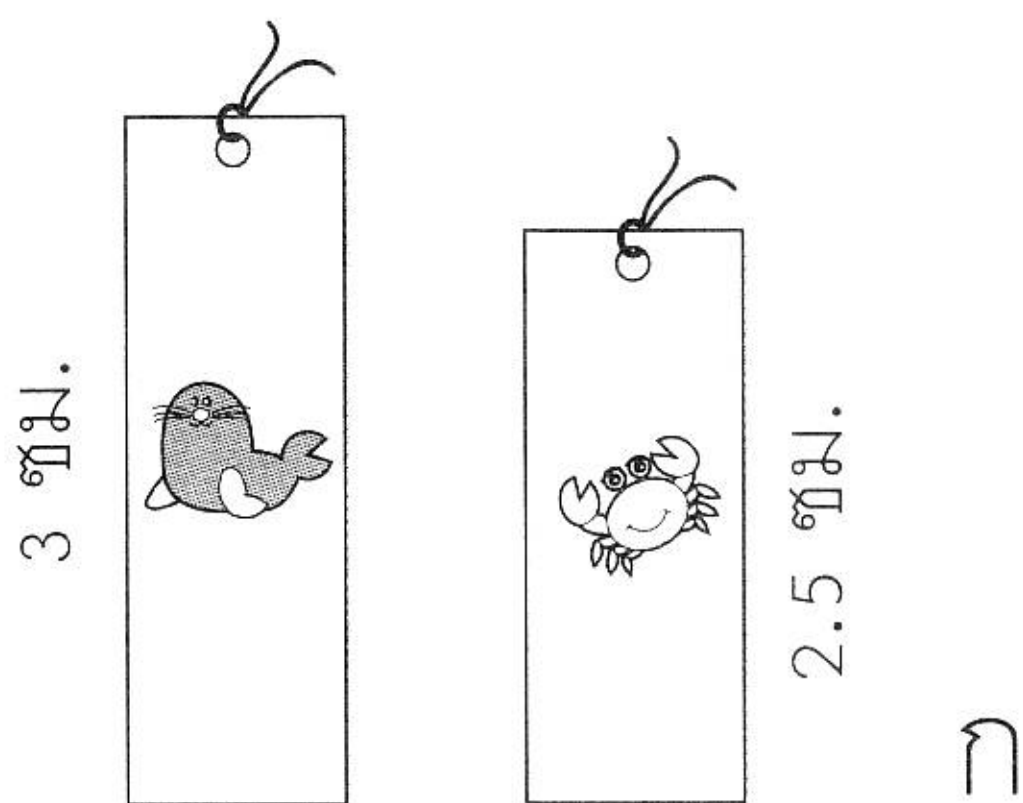
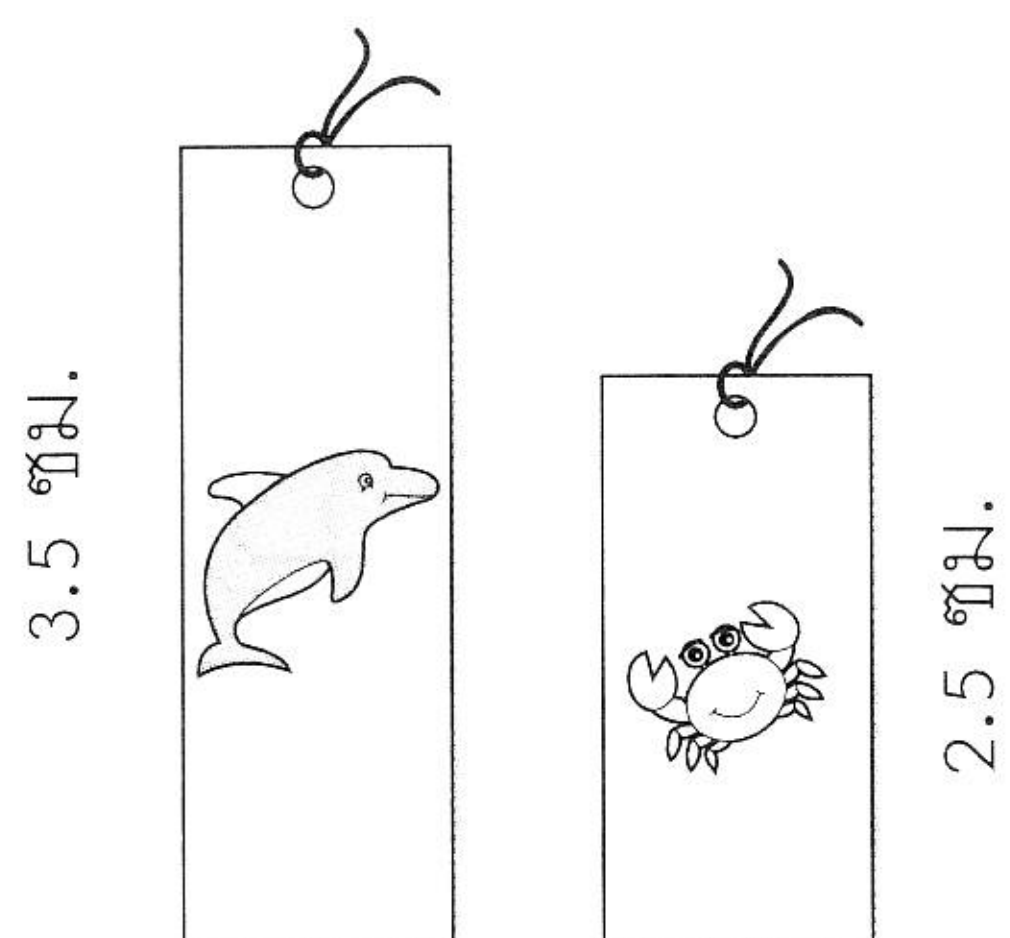

ก

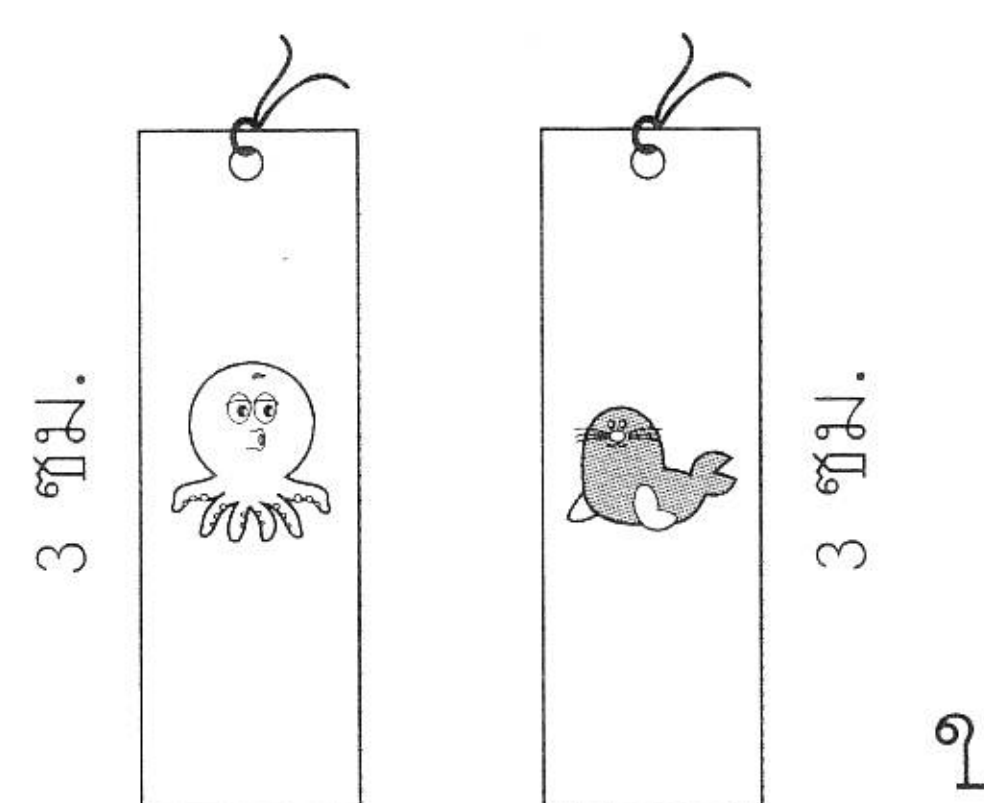

ข

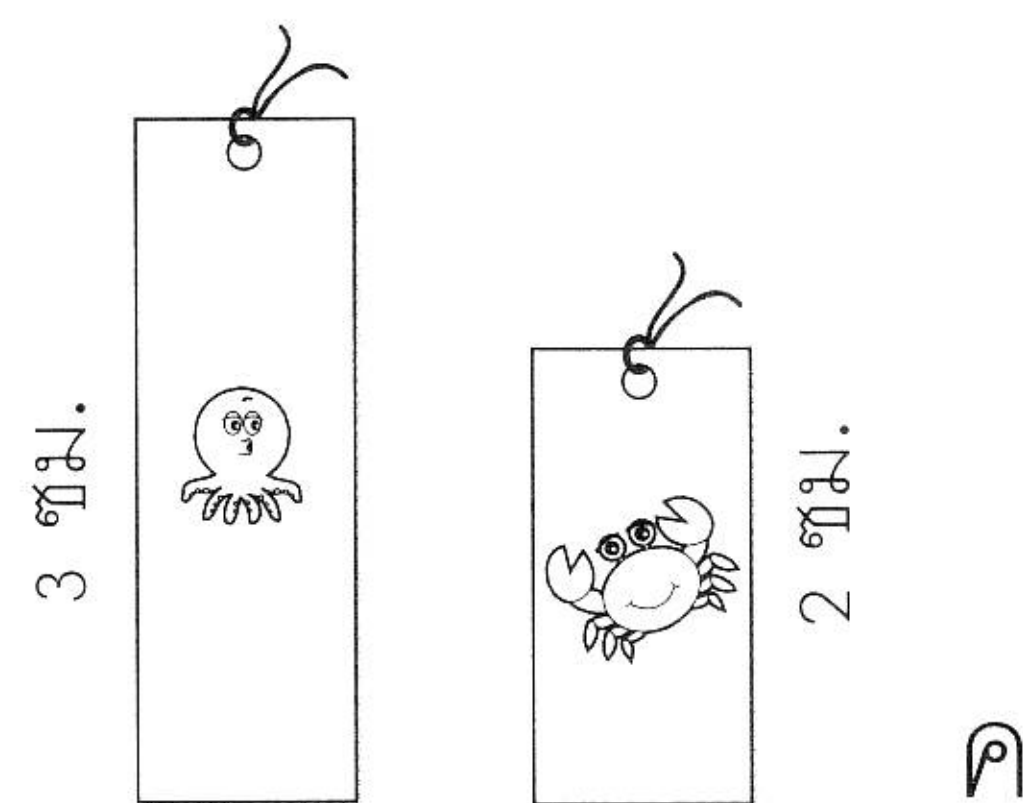

ค

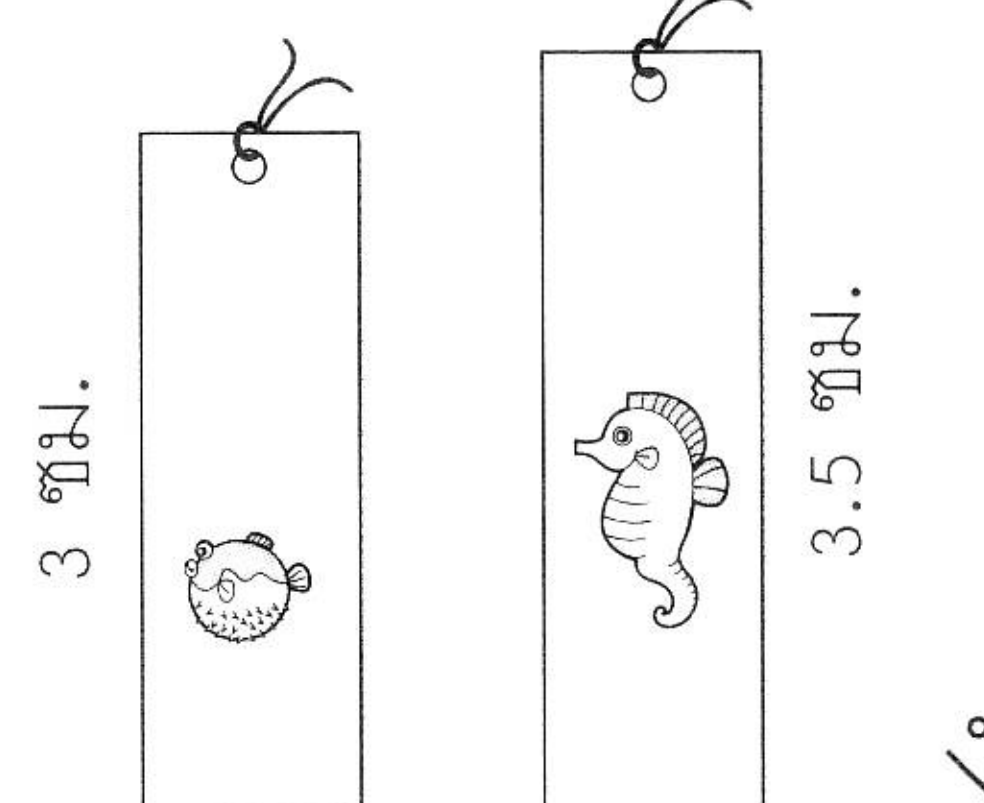

ง

จงขีด ✓ ข้อที่มีพื้นที่ว่างเท่ากับภาพแรก

1 พื้นที่ว่างในชั้นวางรองเท้าใด  
เท่ากับภาพแรก

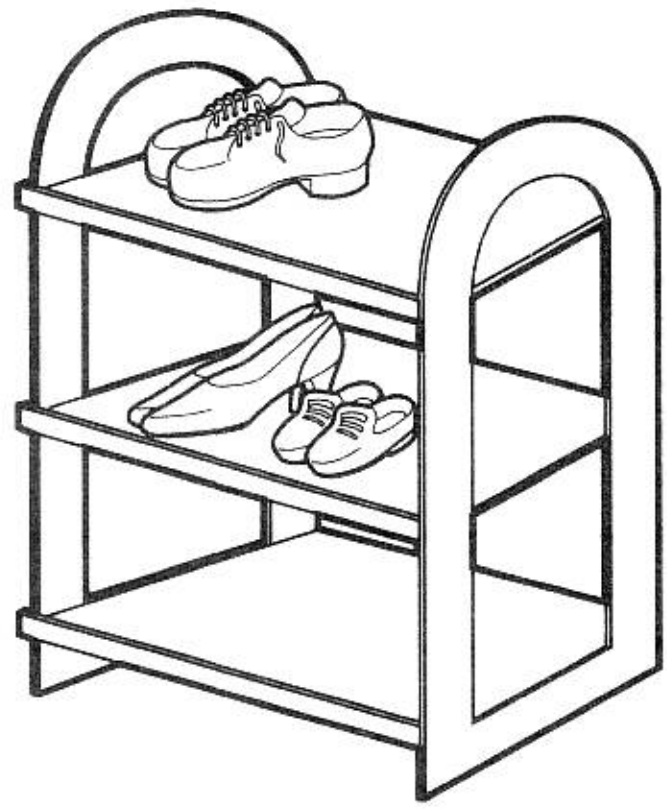
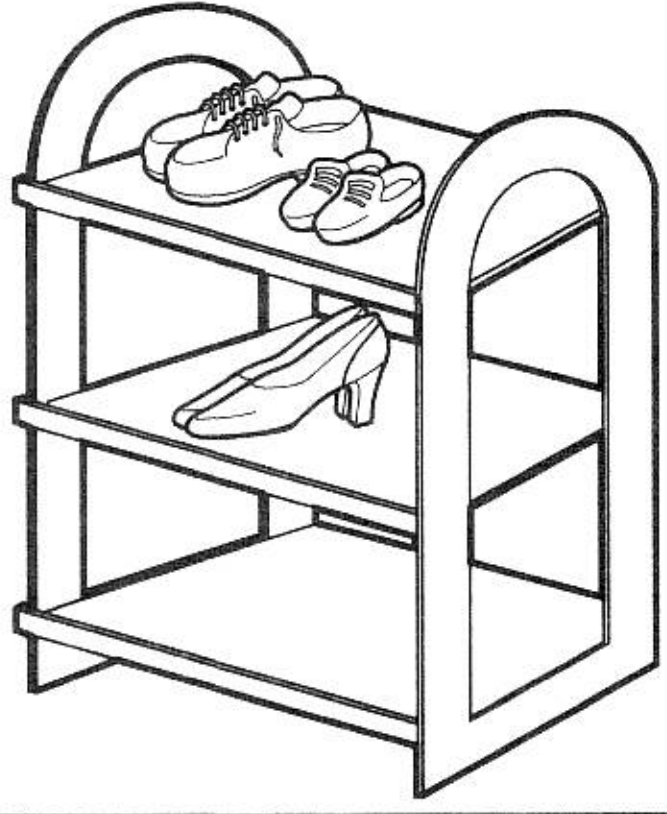

ก

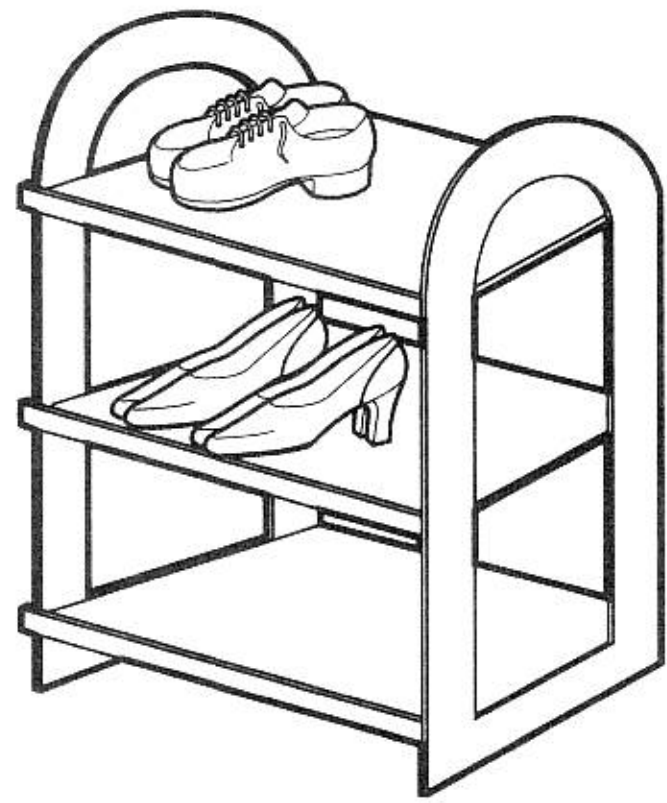

ข

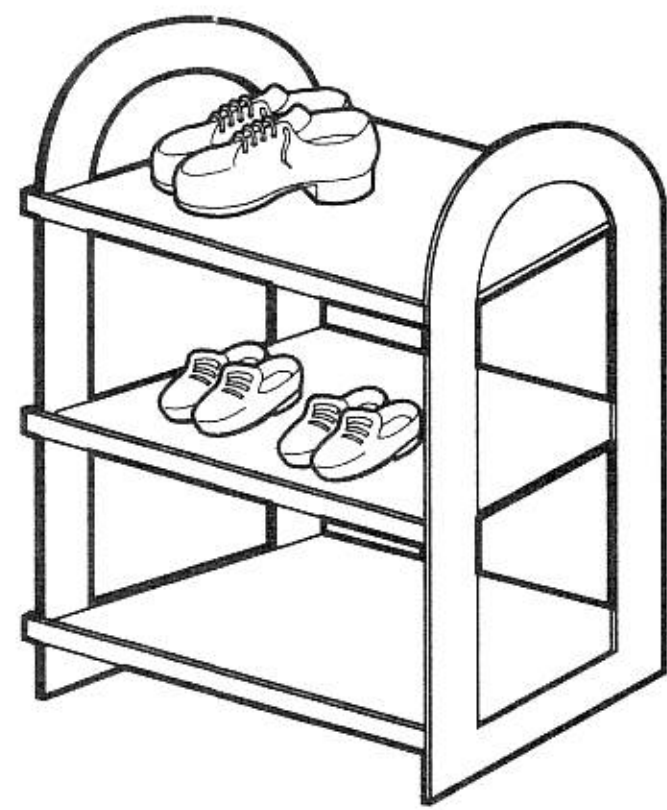

ค

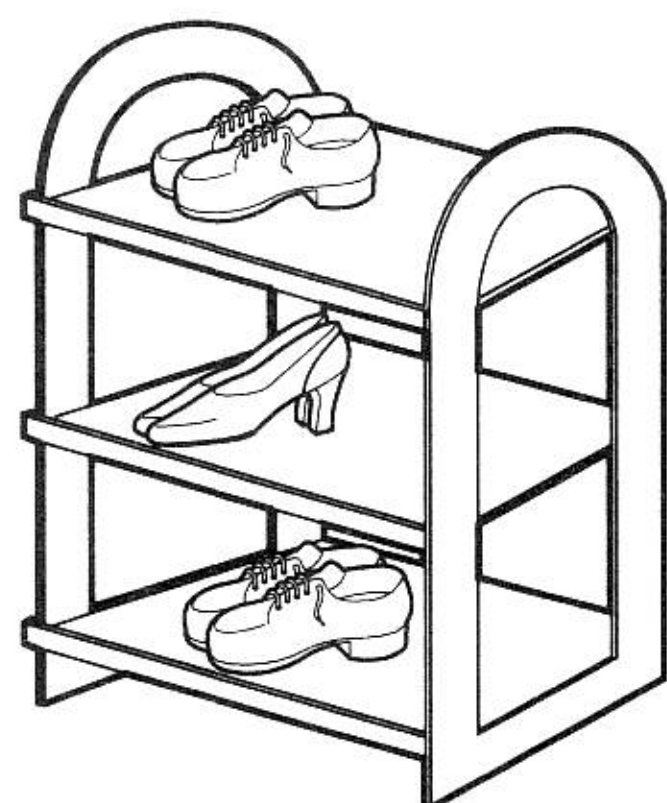

ง

2 พื้นที่ว่างในกล่องใส่ของใด  
เท่ากับภาพแรก

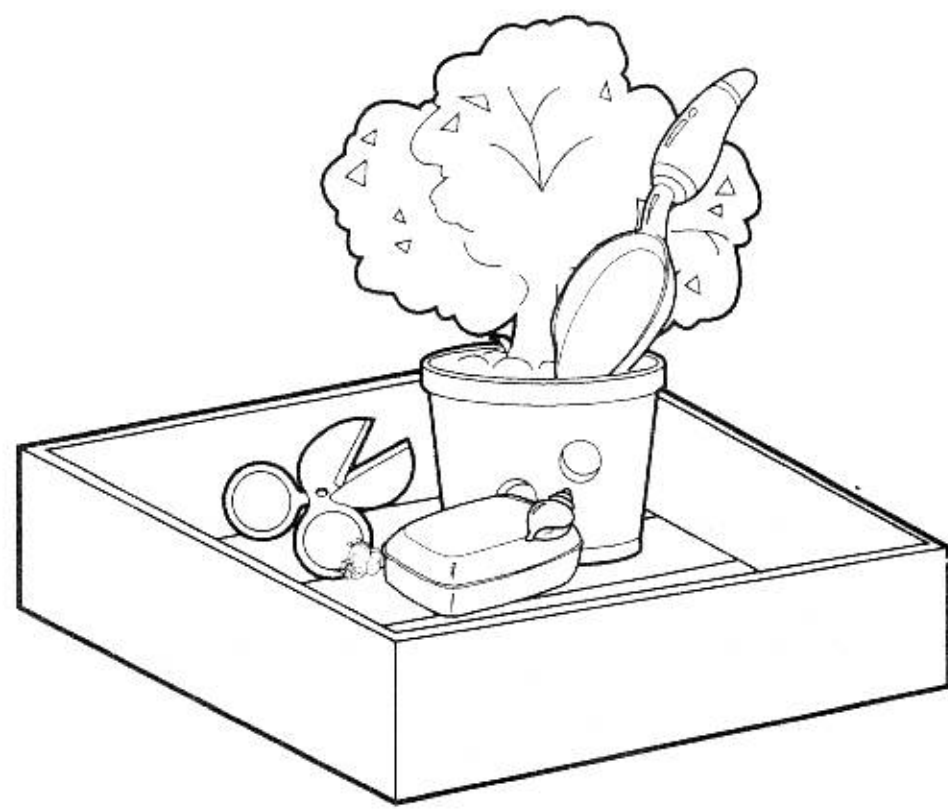
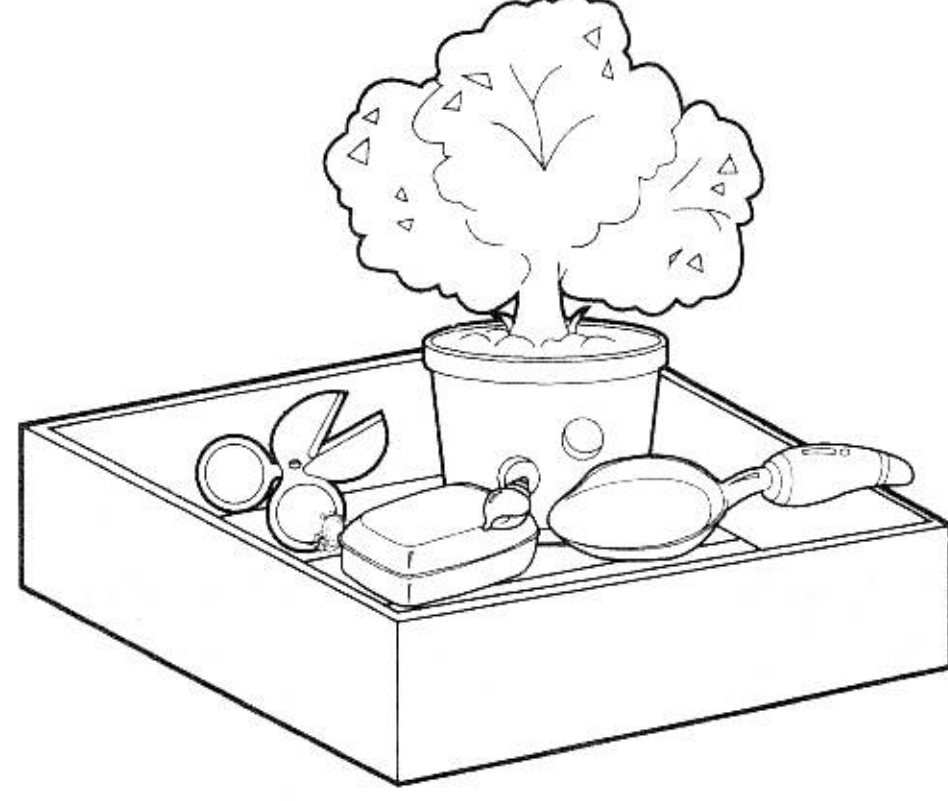

ก

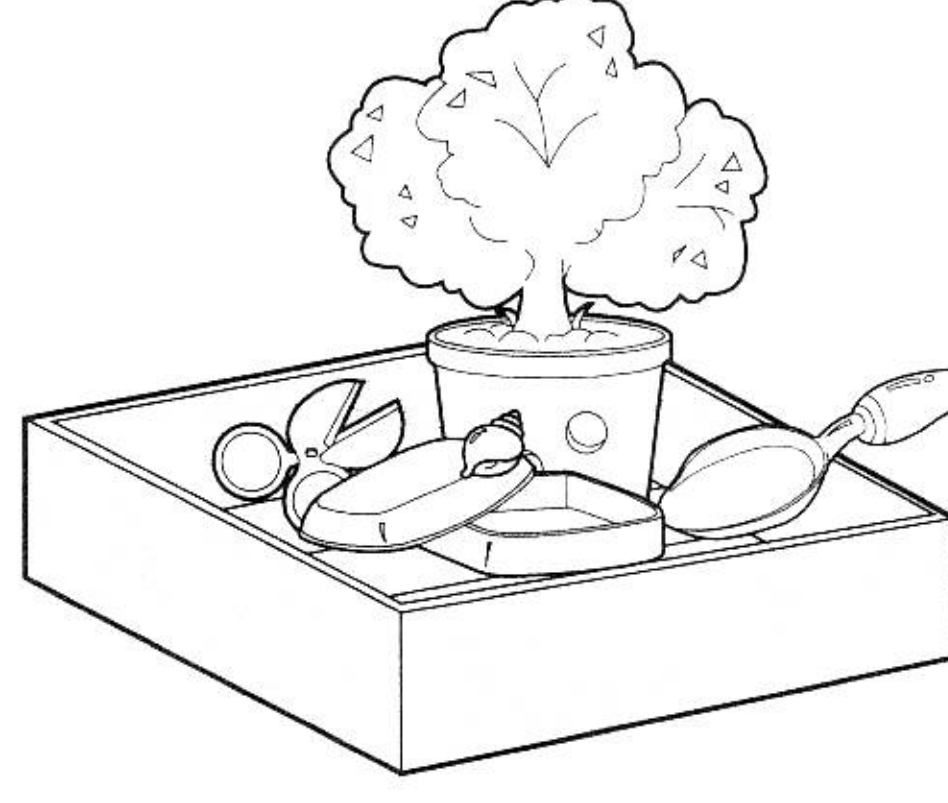

ข

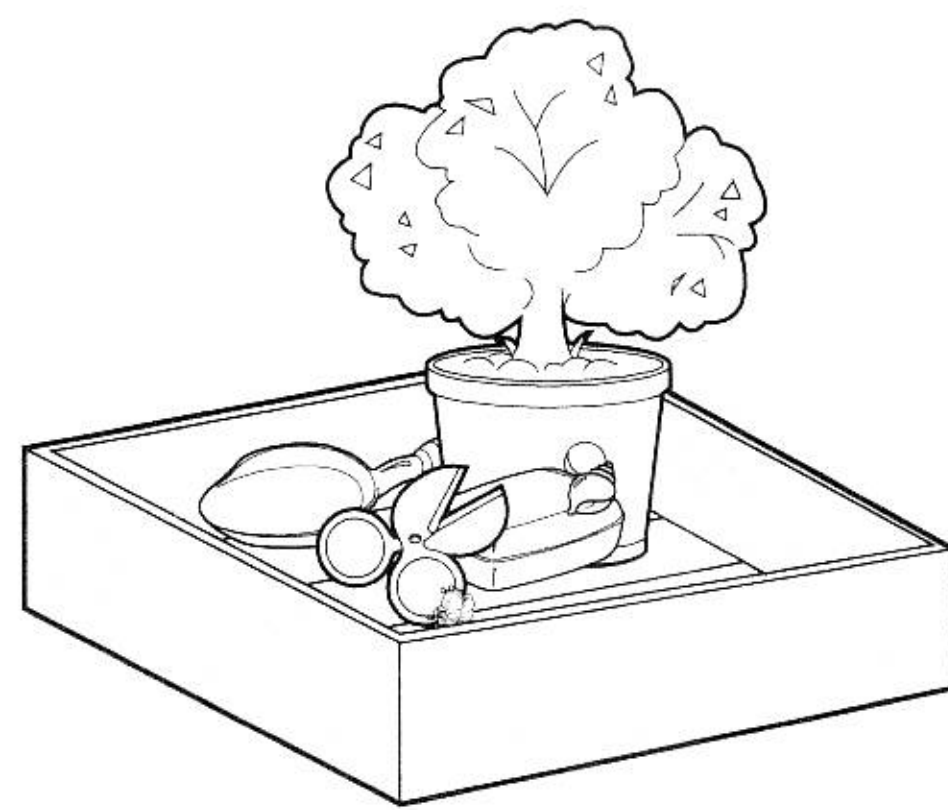

ค

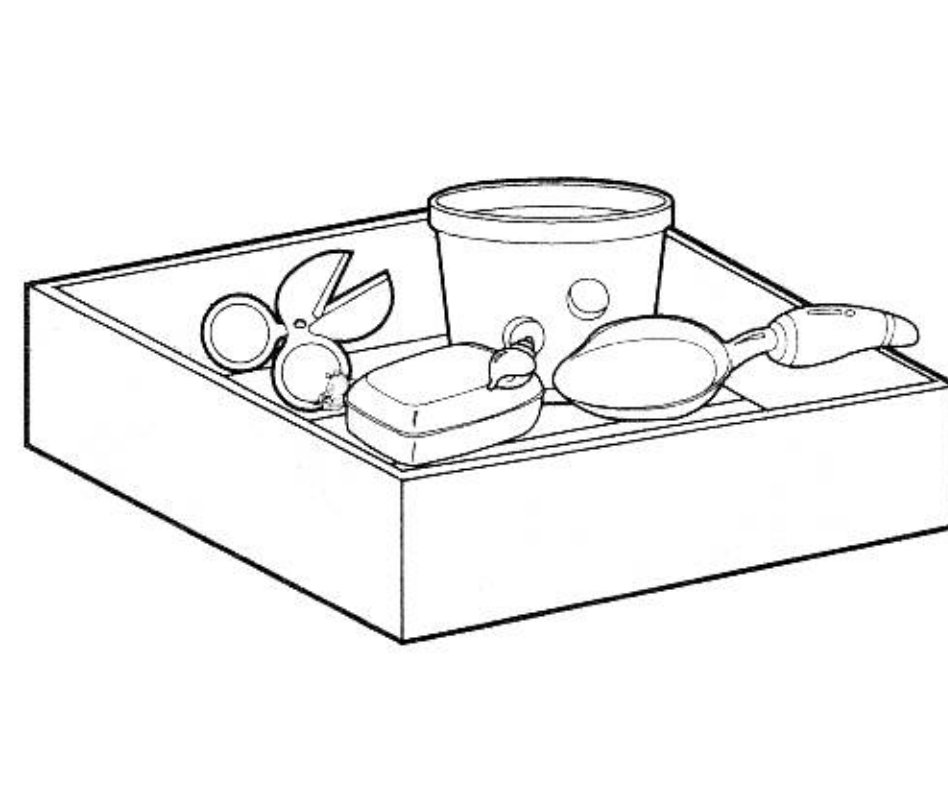

ง

3 พื้นที่ว่างในถาดใบใด  
เท่ากับภาพแรก



ก



ข



ค



ง

4 พื้นที่ว่างบนเสื่อผืนโต  
ที่เท่ากับภาพแรก

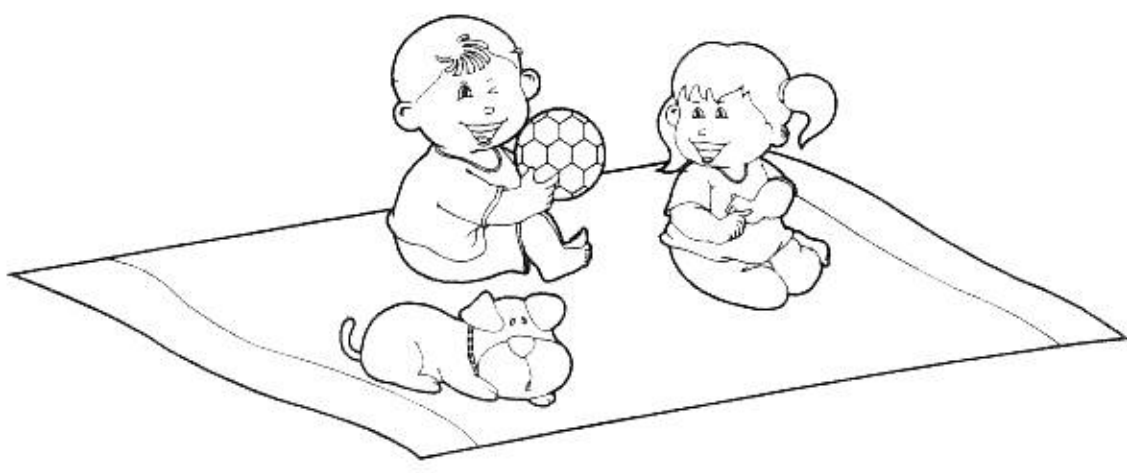
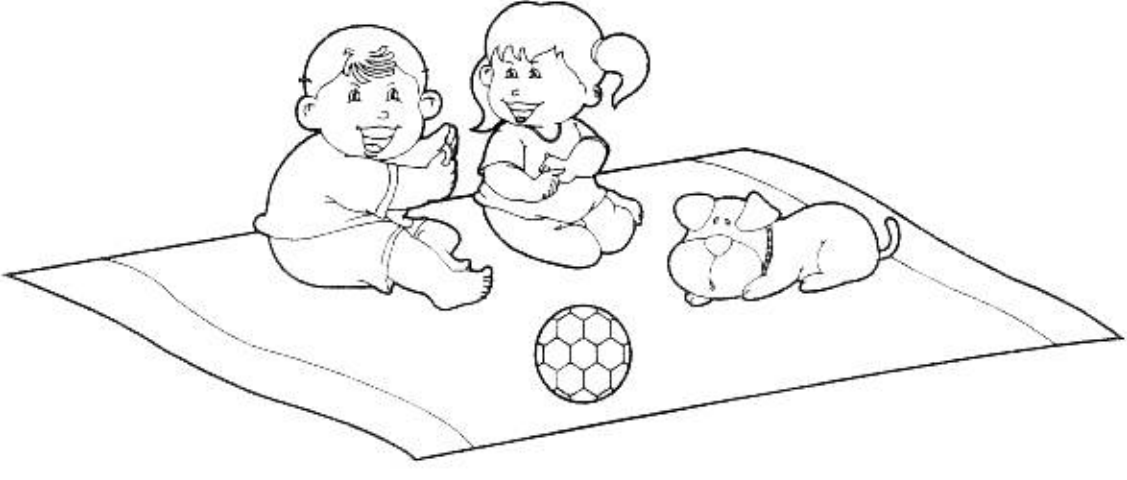

ก

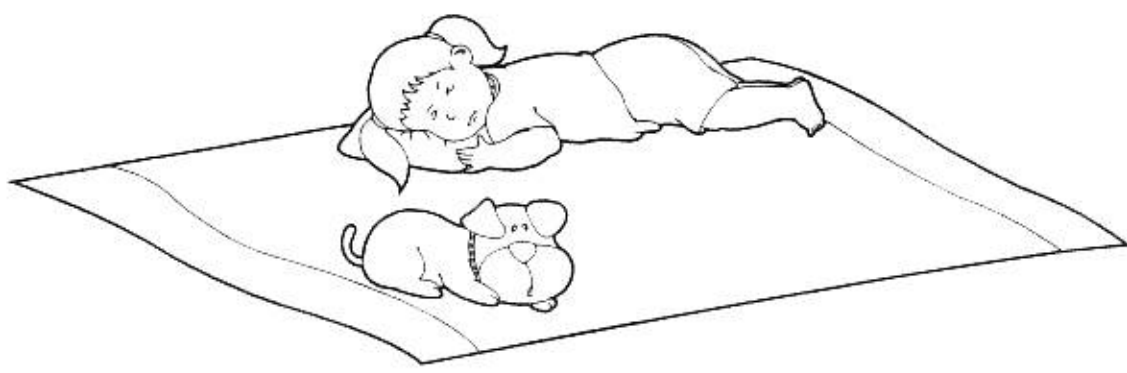

ข

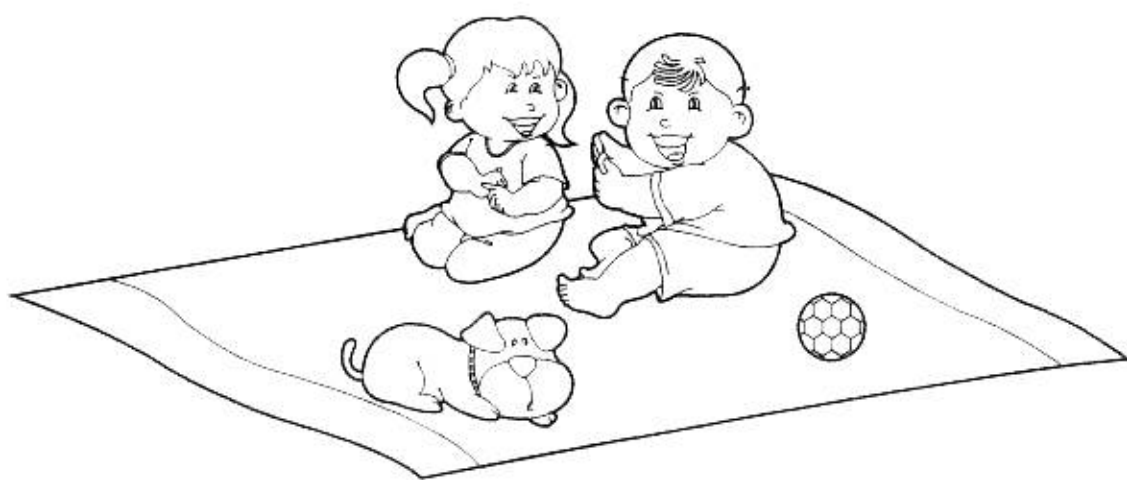

ค

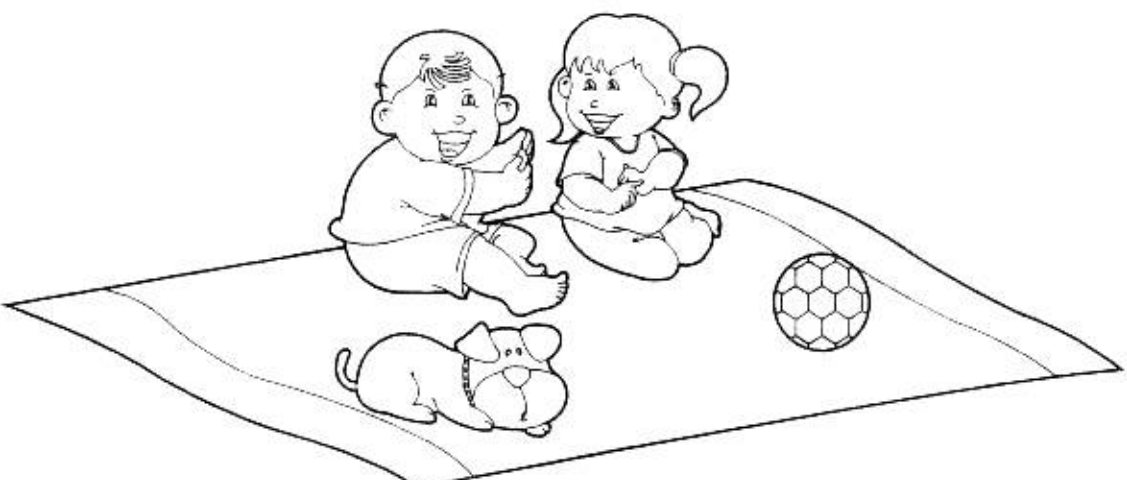

ง

5 พื้นที่ว่างในตู้ใส่เครื่องเขียน  
โตที่เท่ากับภาพแรก

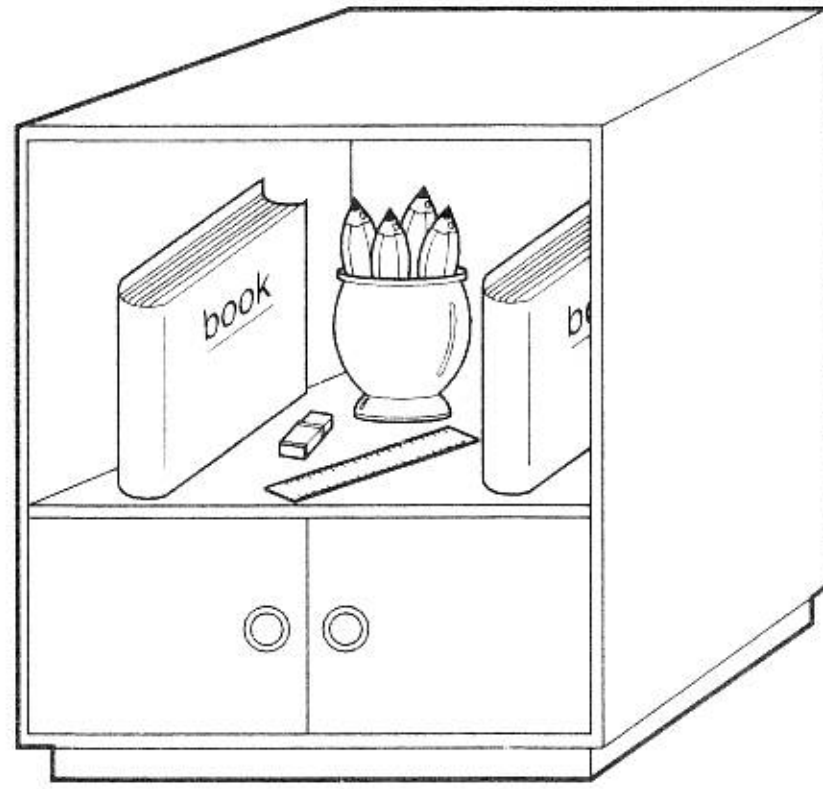
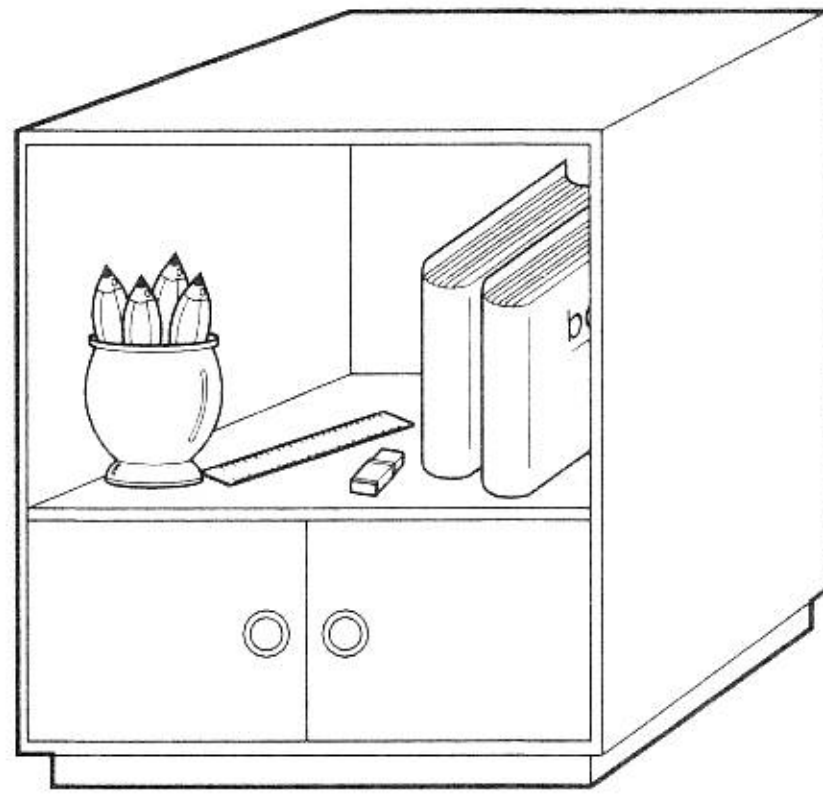

ก

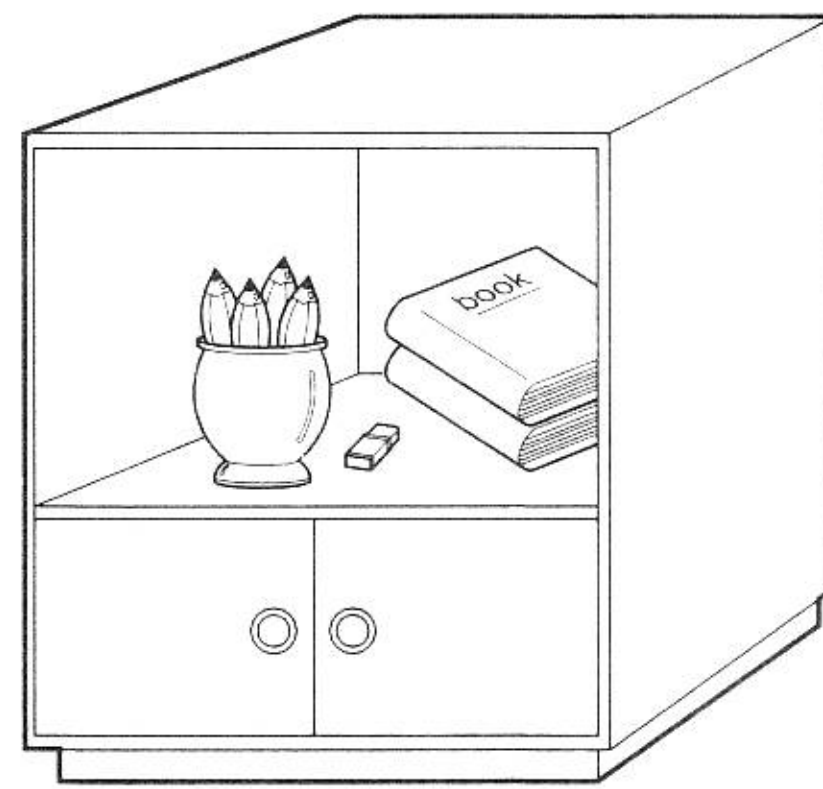

ข

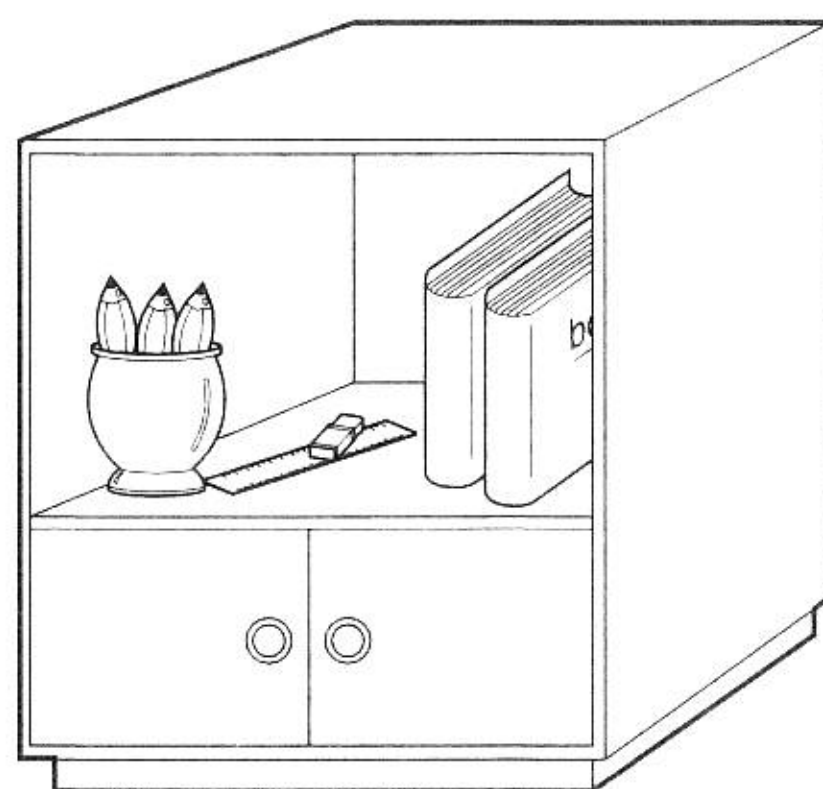

ค

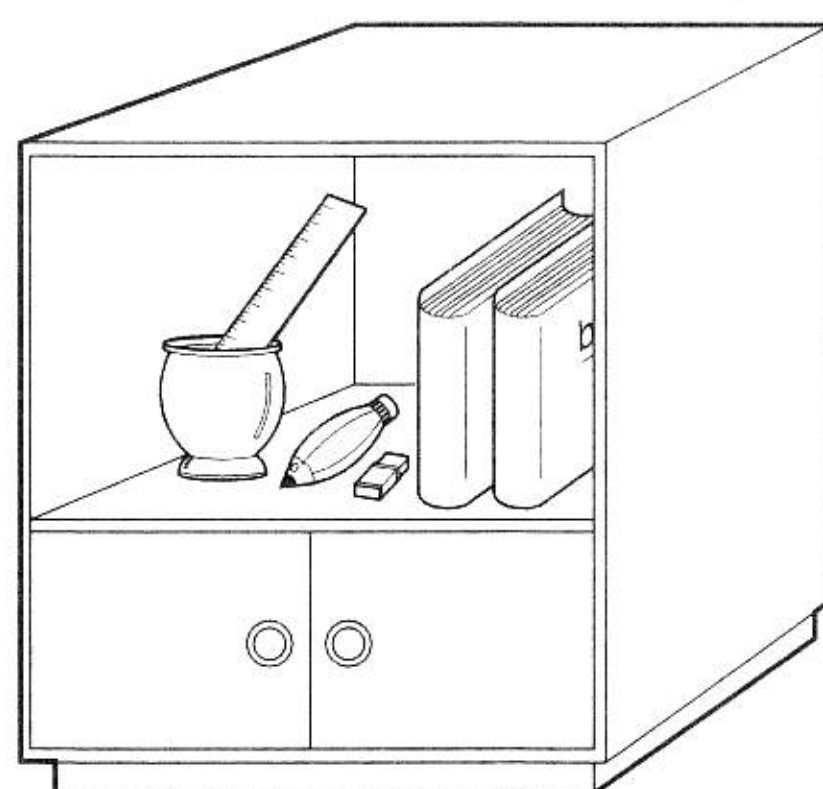

ง

6 พื้นที่ว่างในตู้เสื้อผ้าโต  
เท่ากับภาพแรก

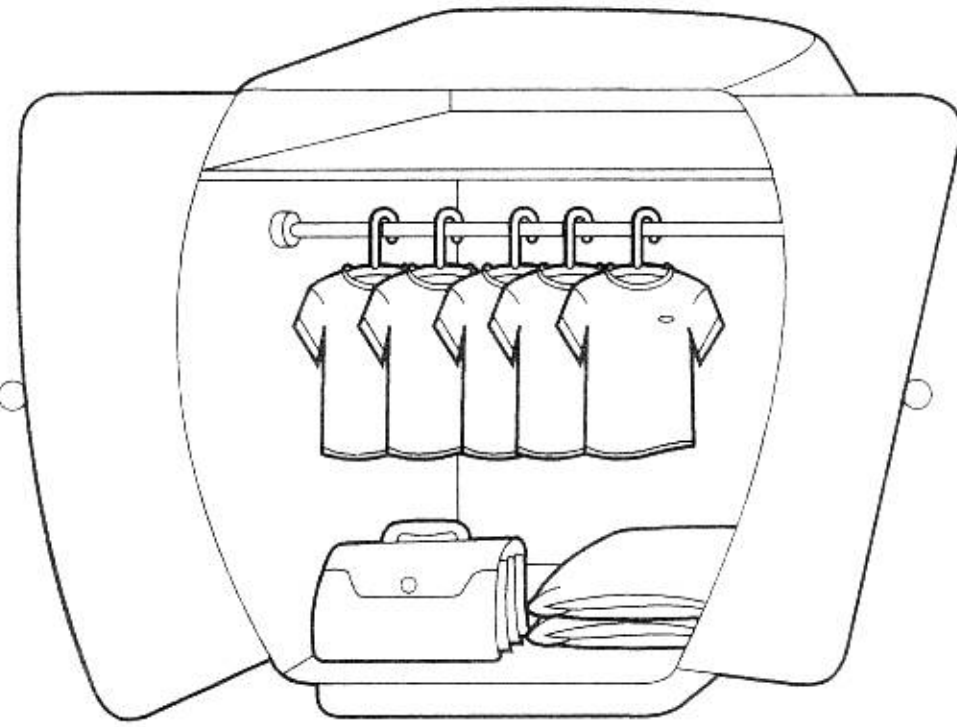
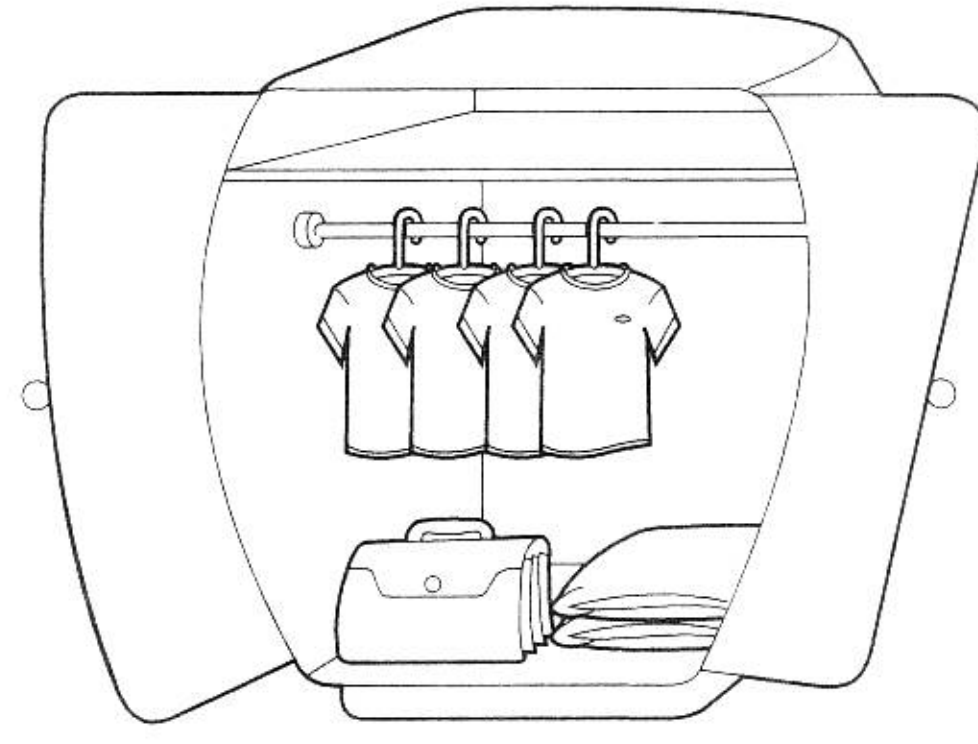

ก

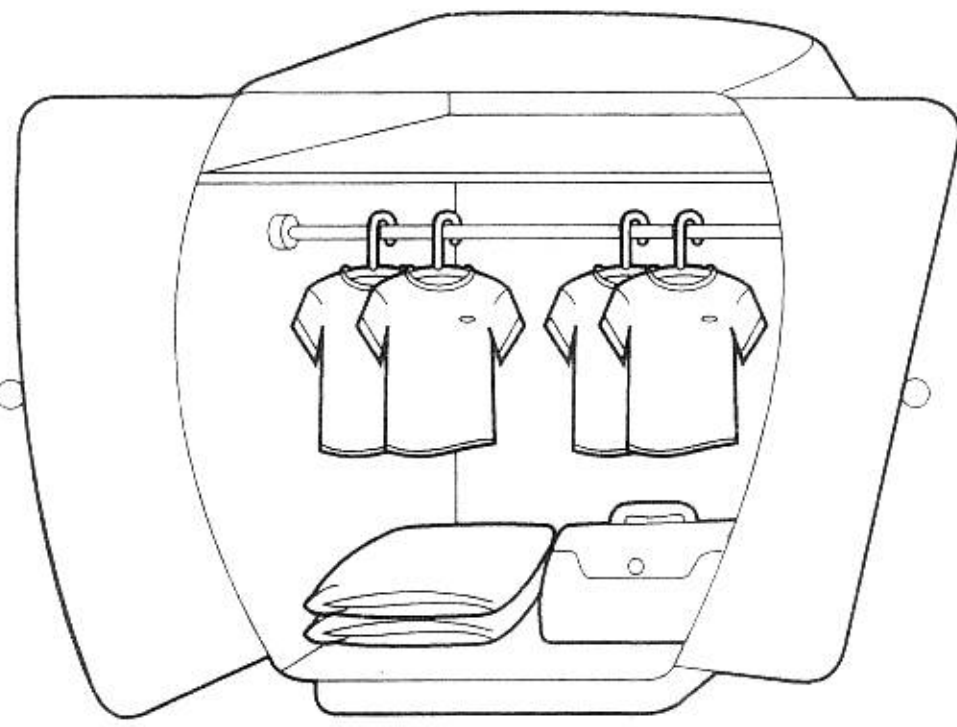

ข

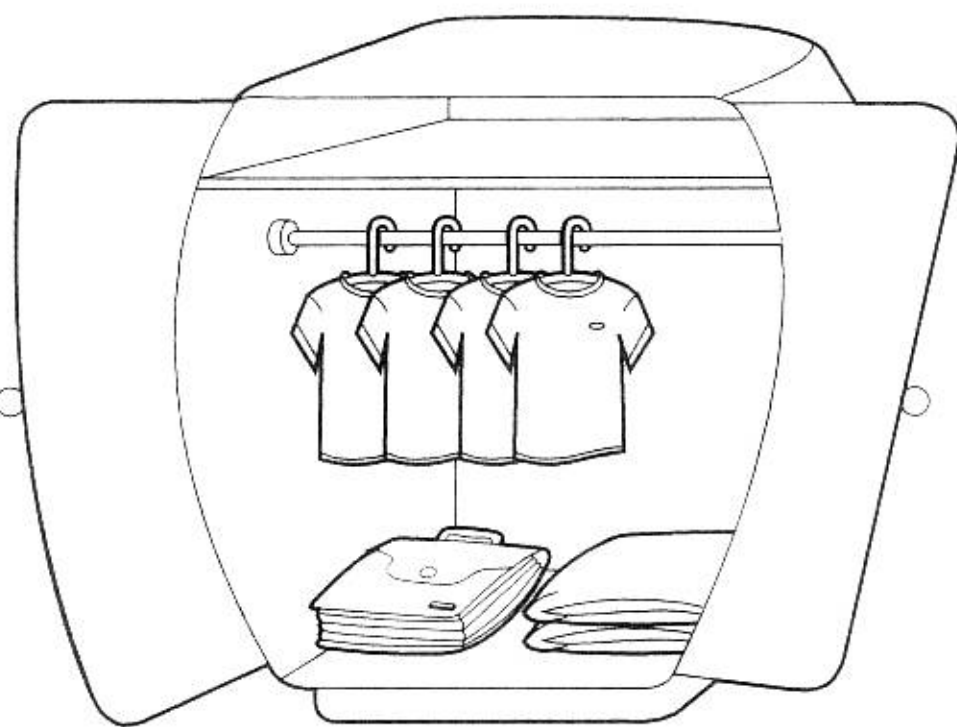

ค

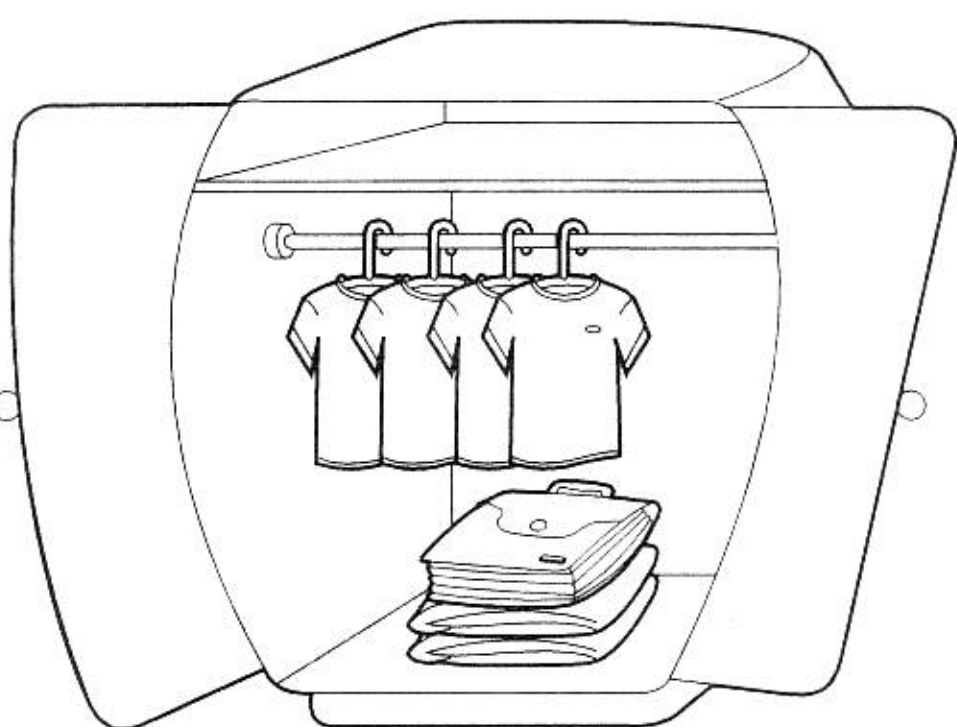

ง

7 ภาพใดที่มีพื้นที่ที่ยังไม่ได้  
ระบายสีเท่ากับภาพแรก

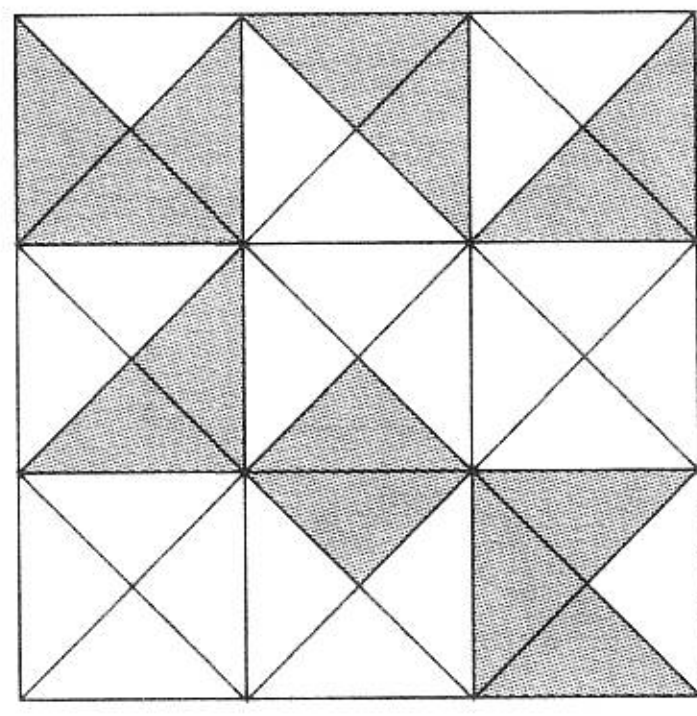
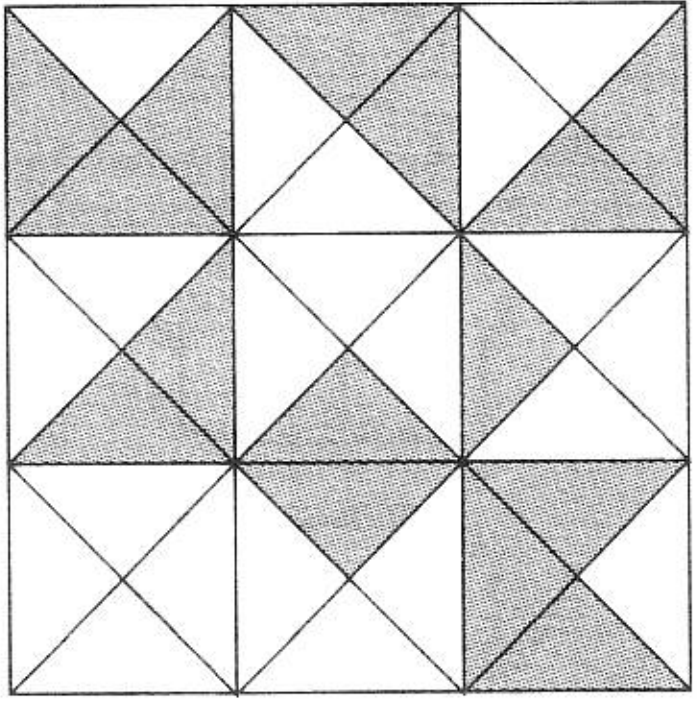

ก

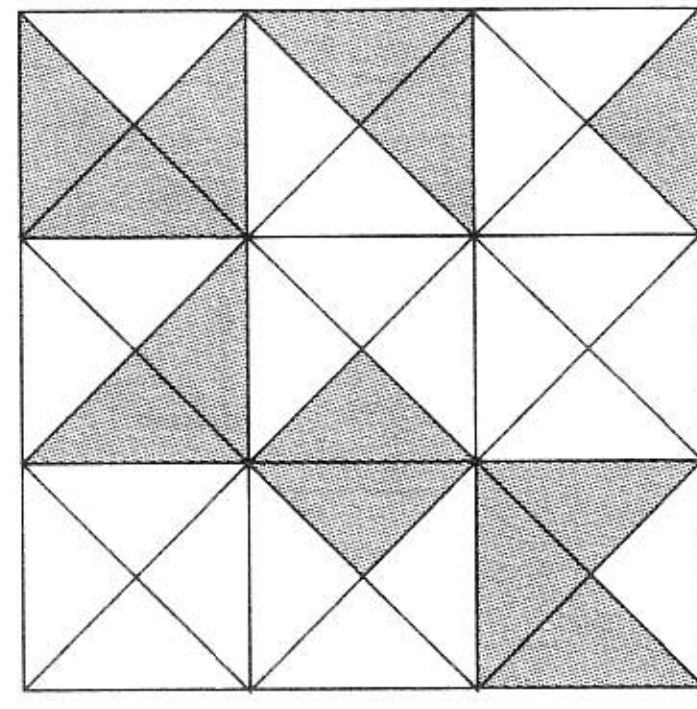

ข

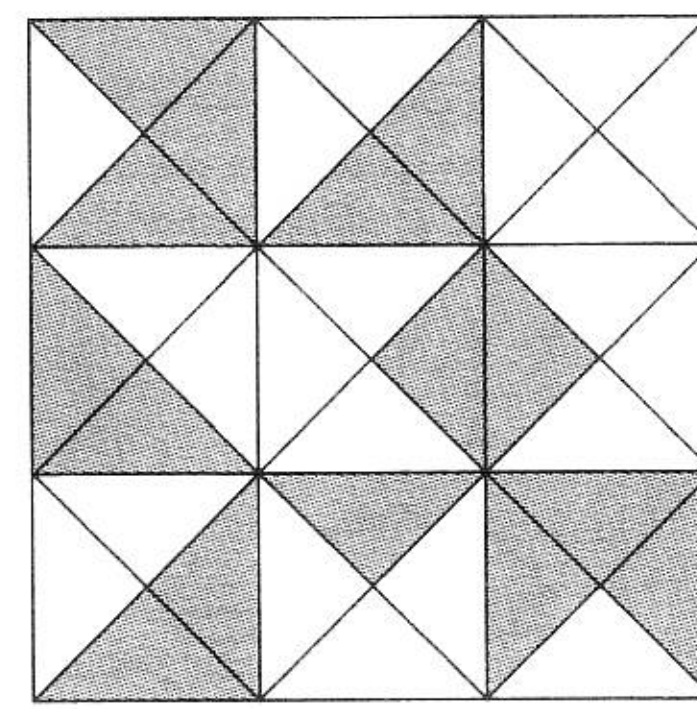

ค

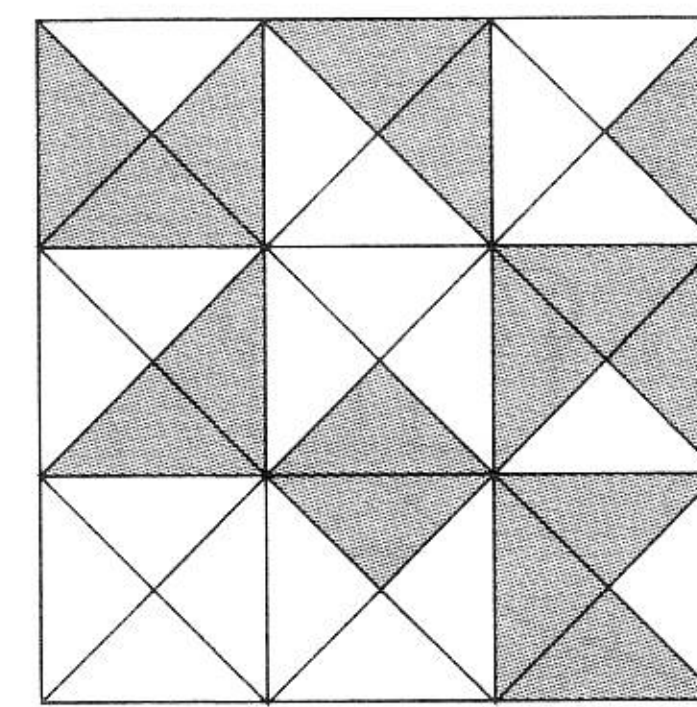

ง

8 พื้นที่ว่างบนโต๊ะภาพใด  
เท่ากับภาพแรก

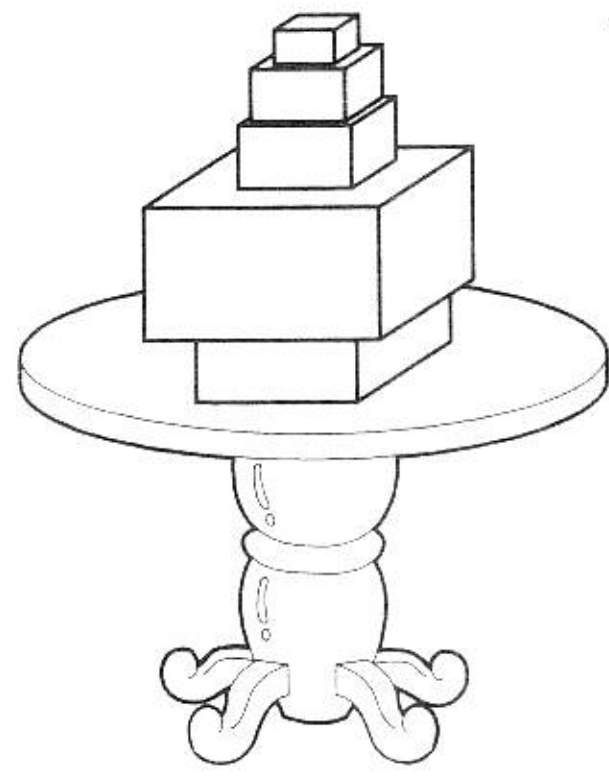
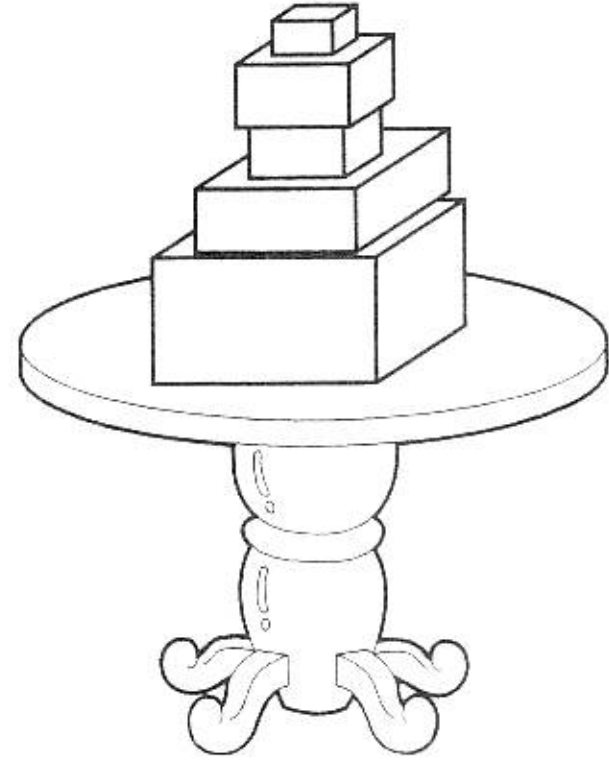

ก

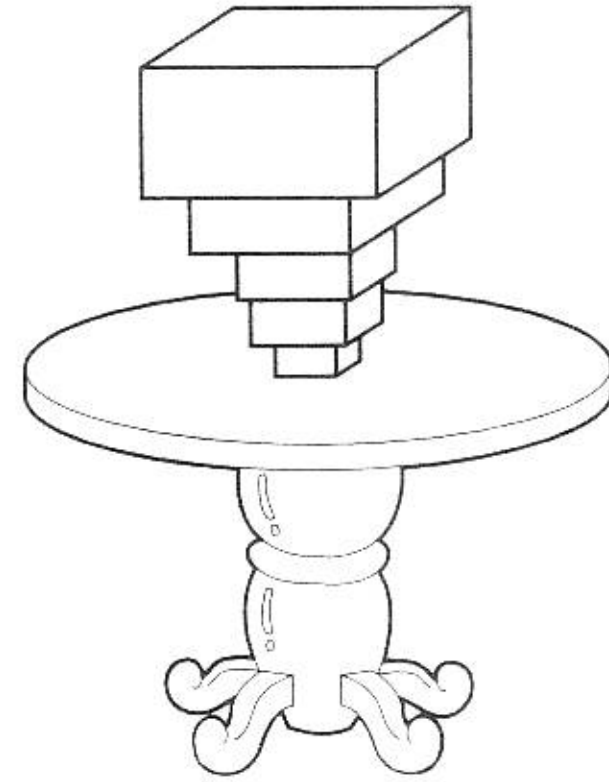

ข

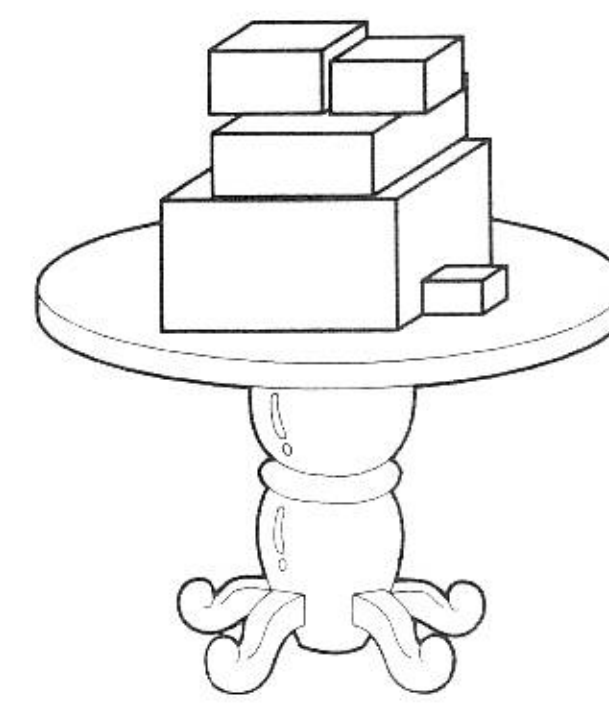

ค



ง

9 พื้นที่ที่ยังไม่ได้ระบายสี  
ภาพใดที่เท่ากับภาพแรก

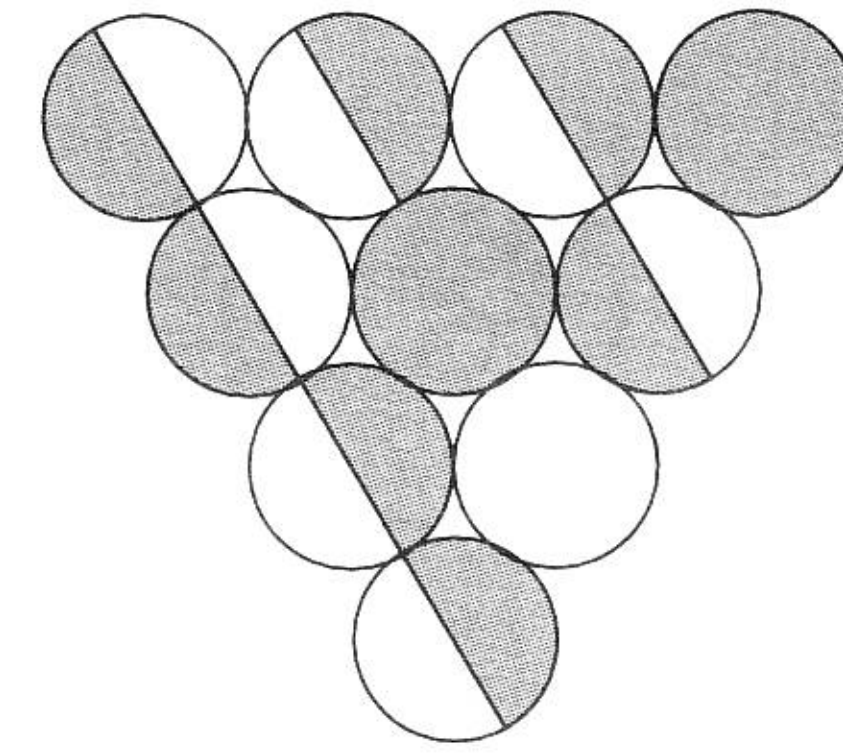
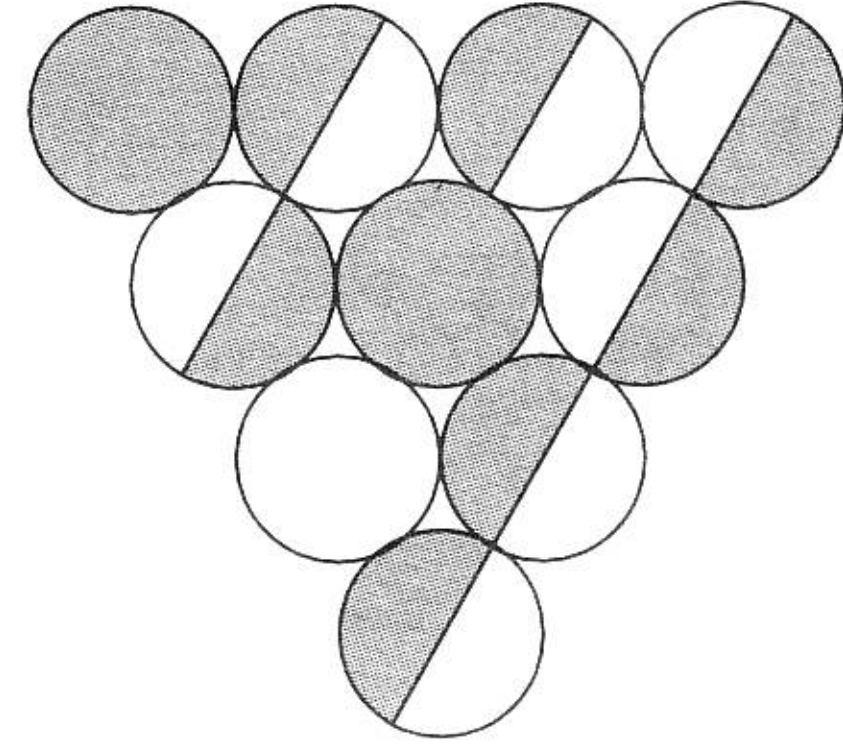

ก

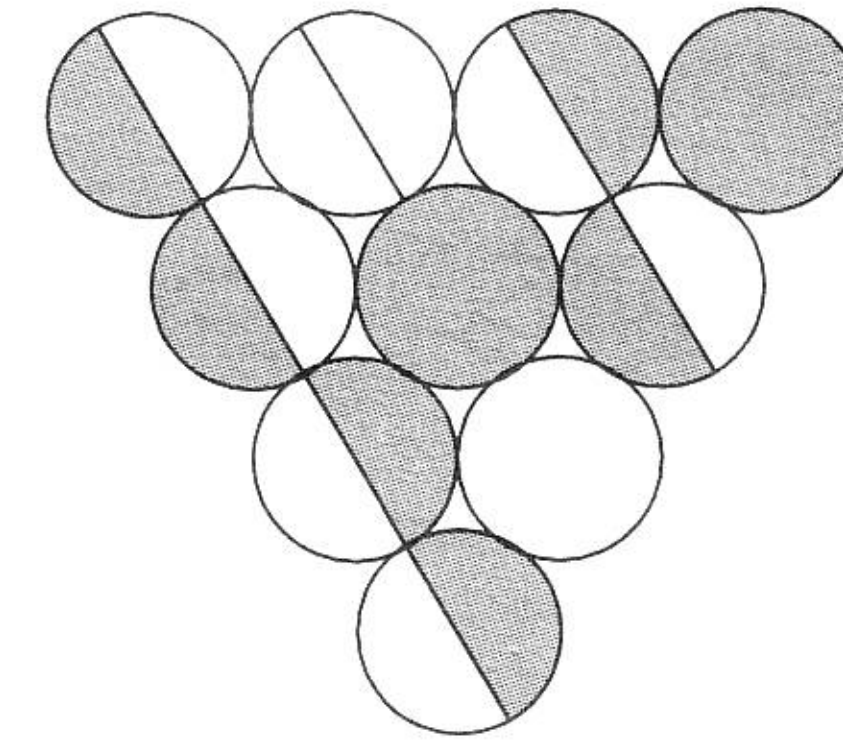

ข

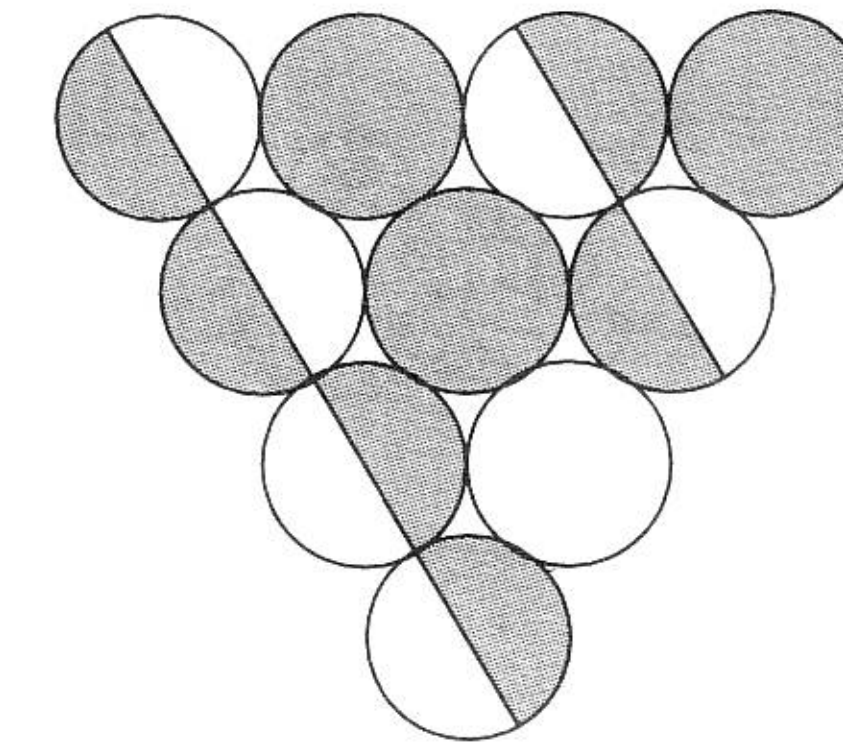

ค

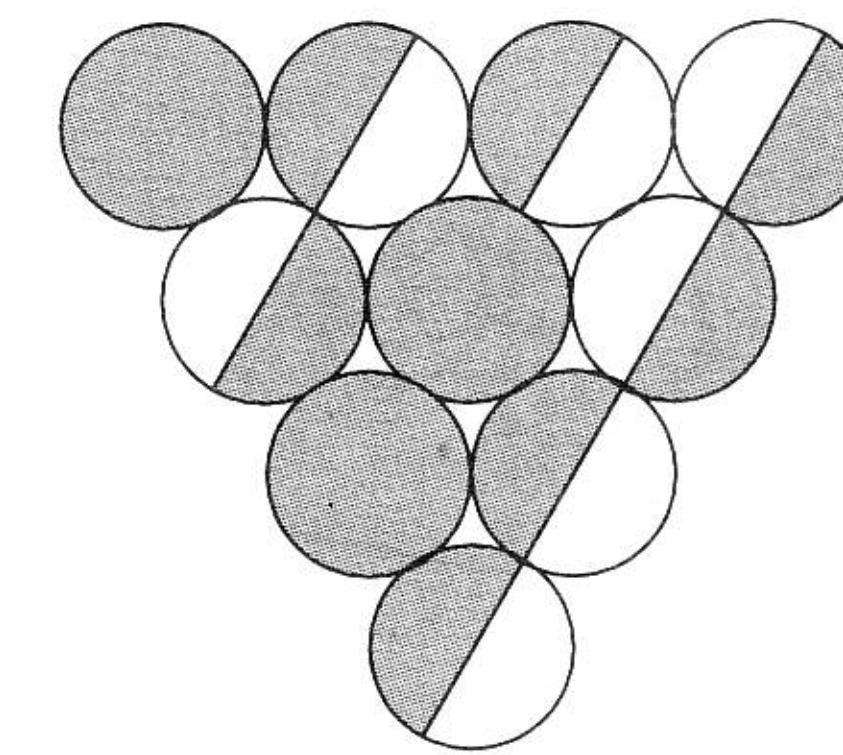

ง

10 ภาพใดที่มีพื้นที่ว่าง  
บนม้านั่งที่เท่ากับภาพแรก

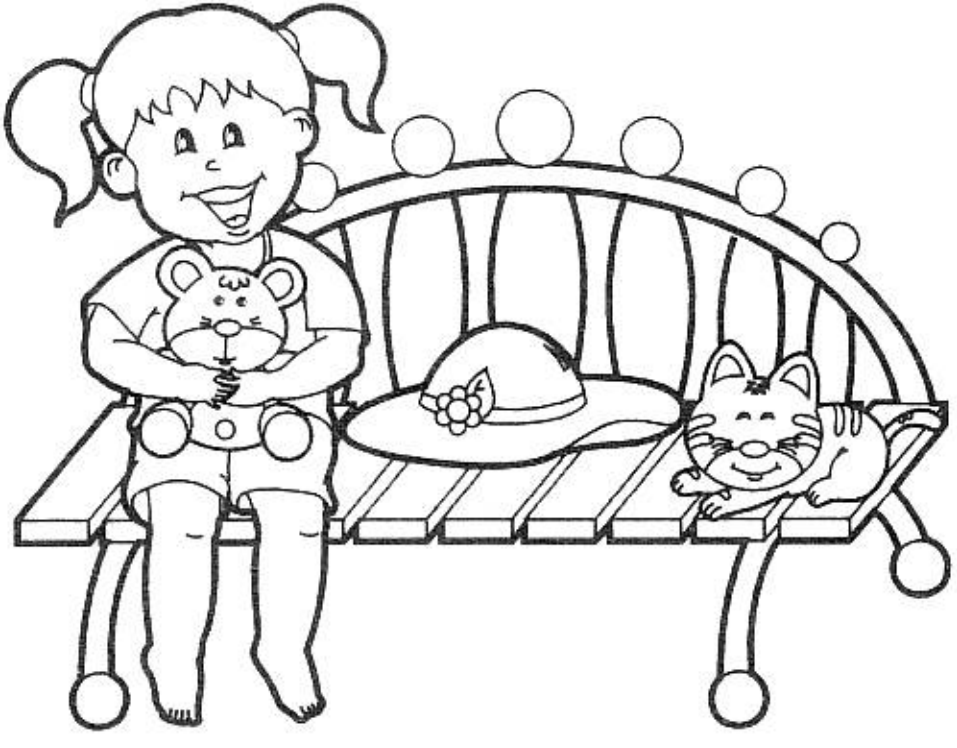

ก



ข

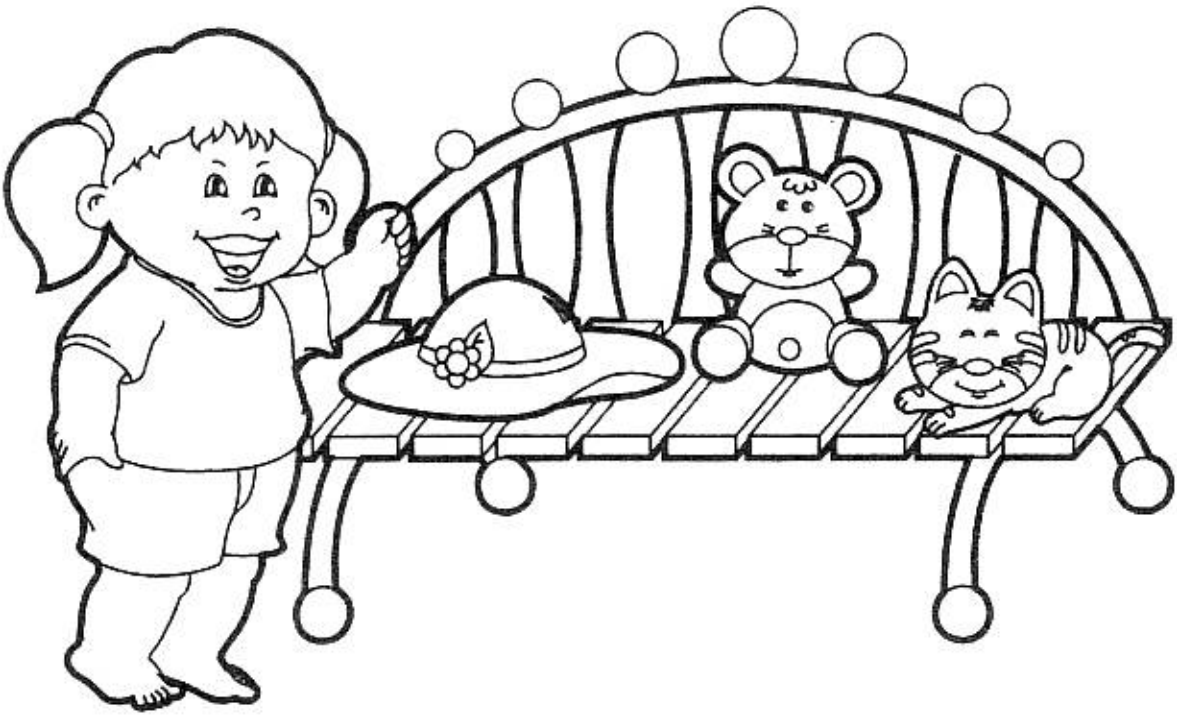

ค

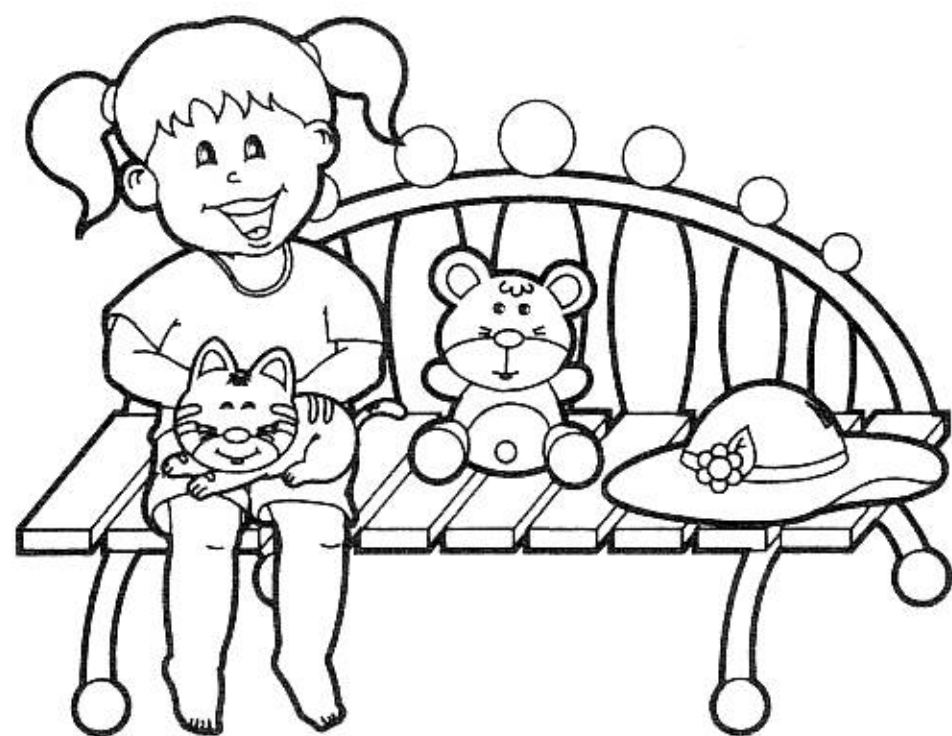

ง

11 ภาพใดที่มีพื้นที่ว่าง  
บนรถเข็นที่เท่ากับภาพแรก

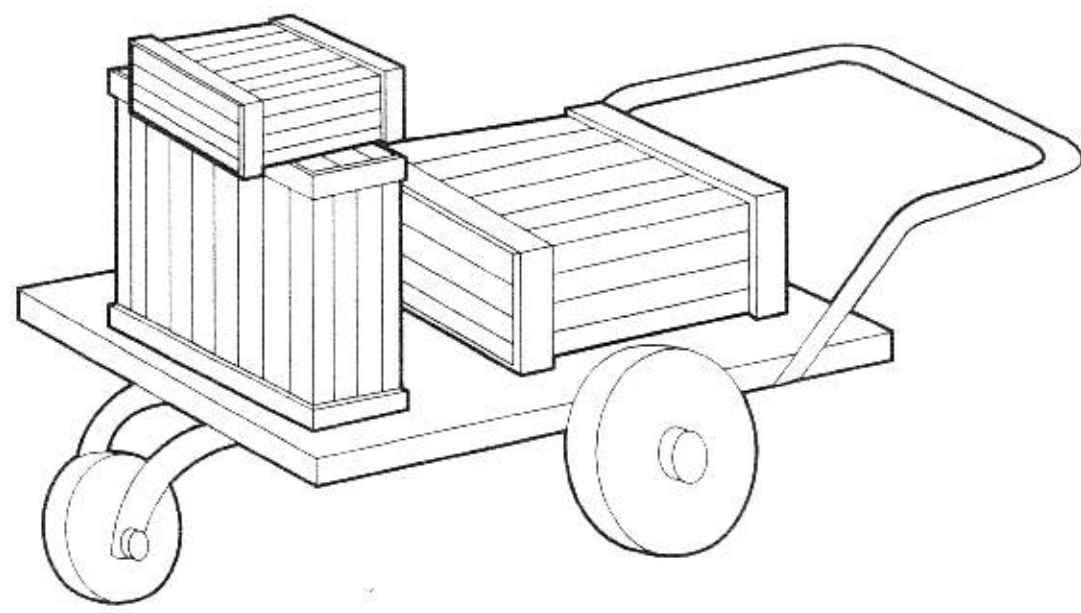
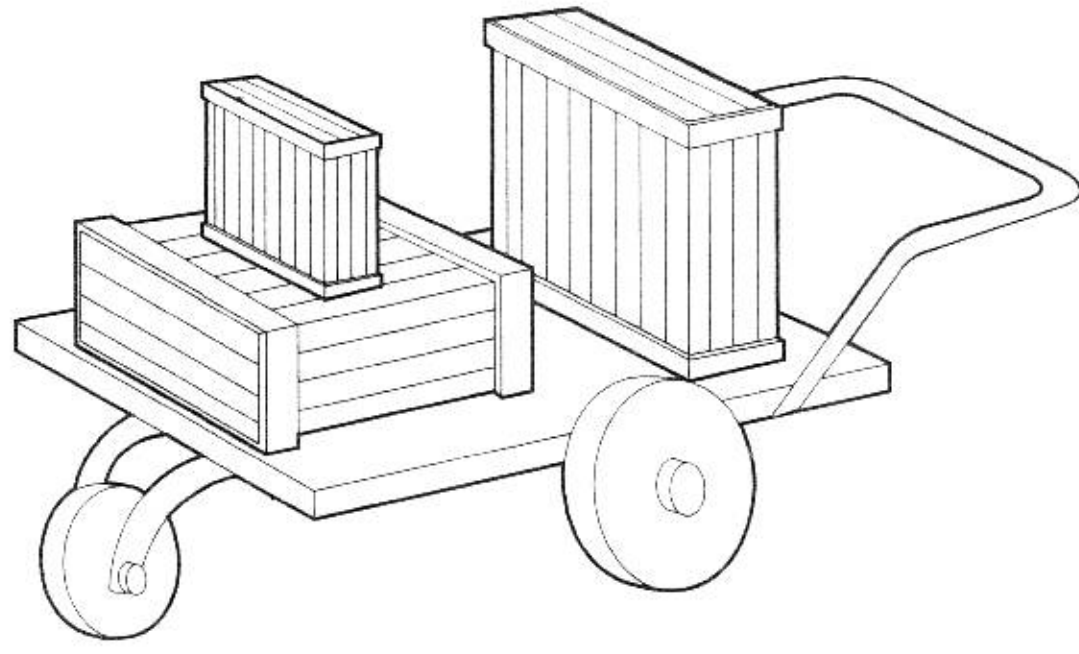

ก

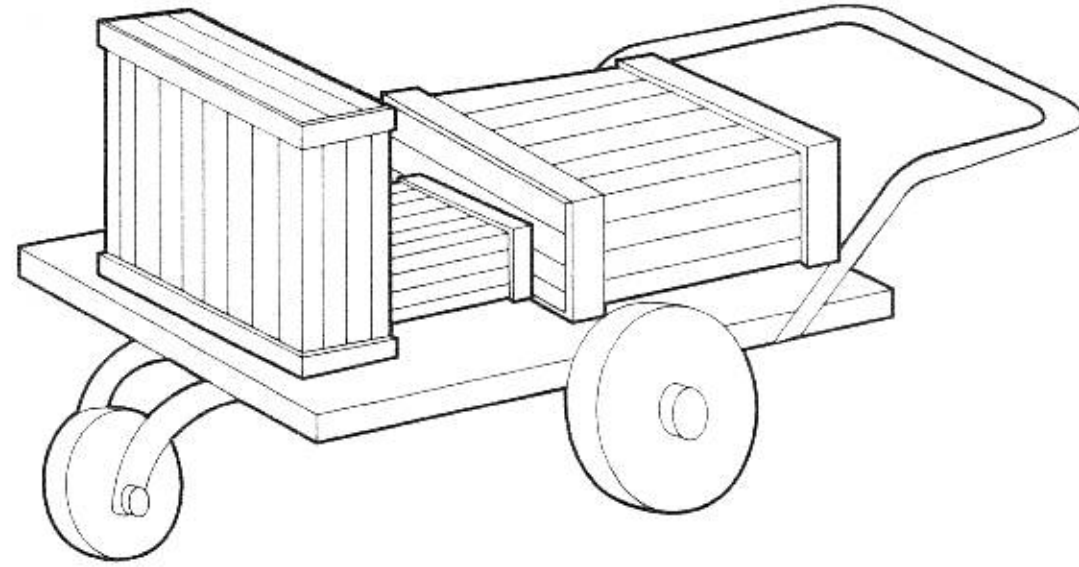

ข

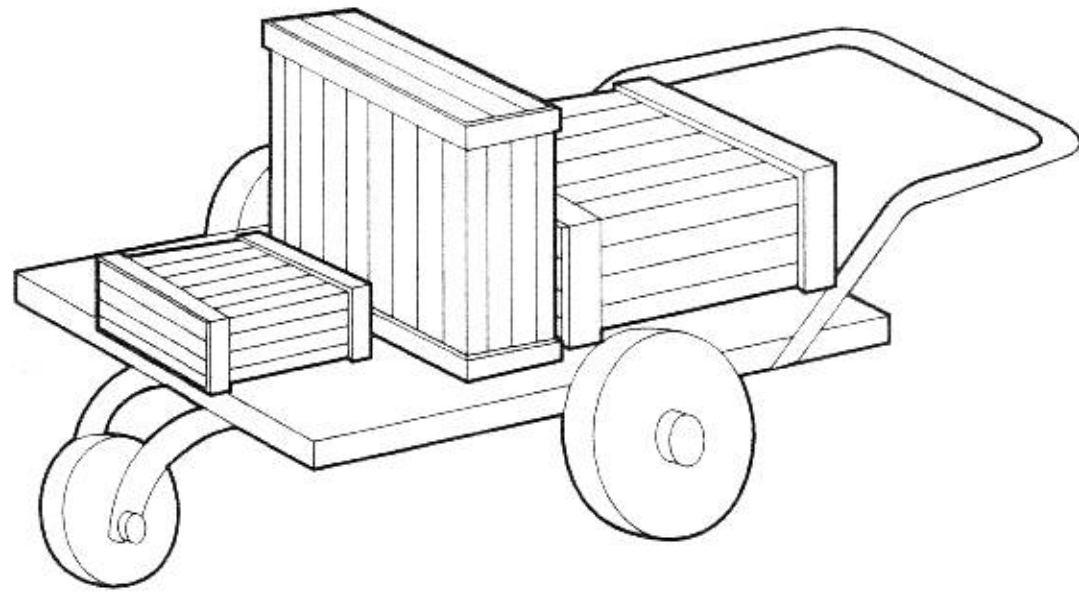

ค

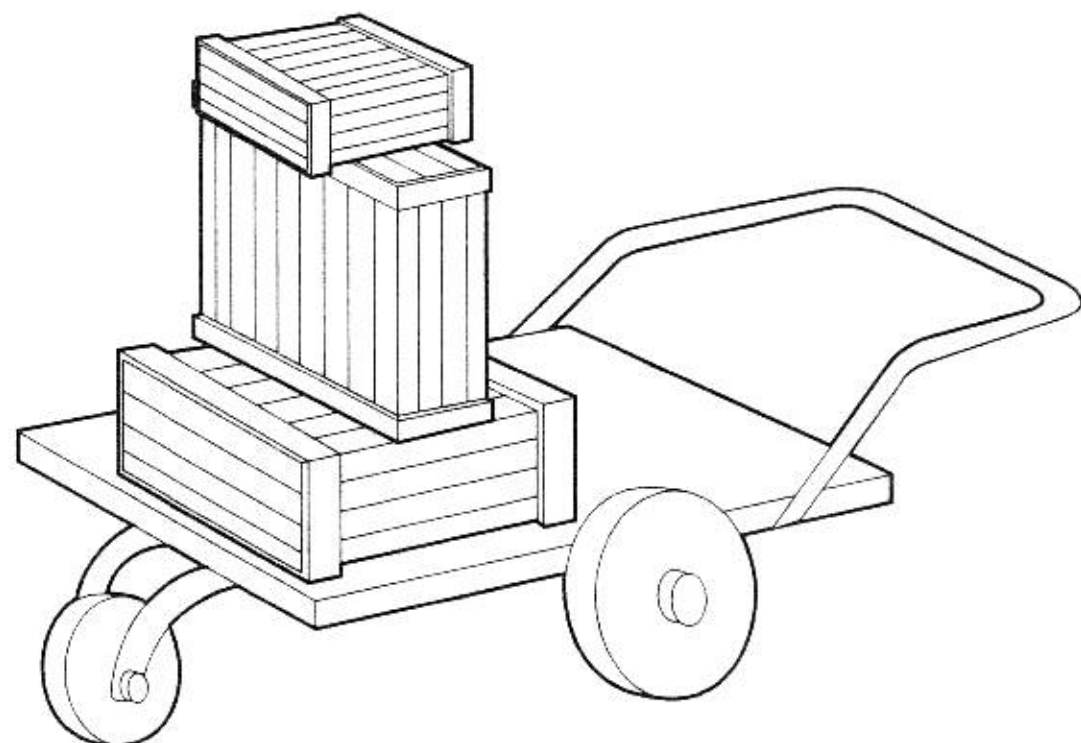

ง

12 พื้นที่ว่างบนเตียงใด  
ที่เท่ากับภาพแรก

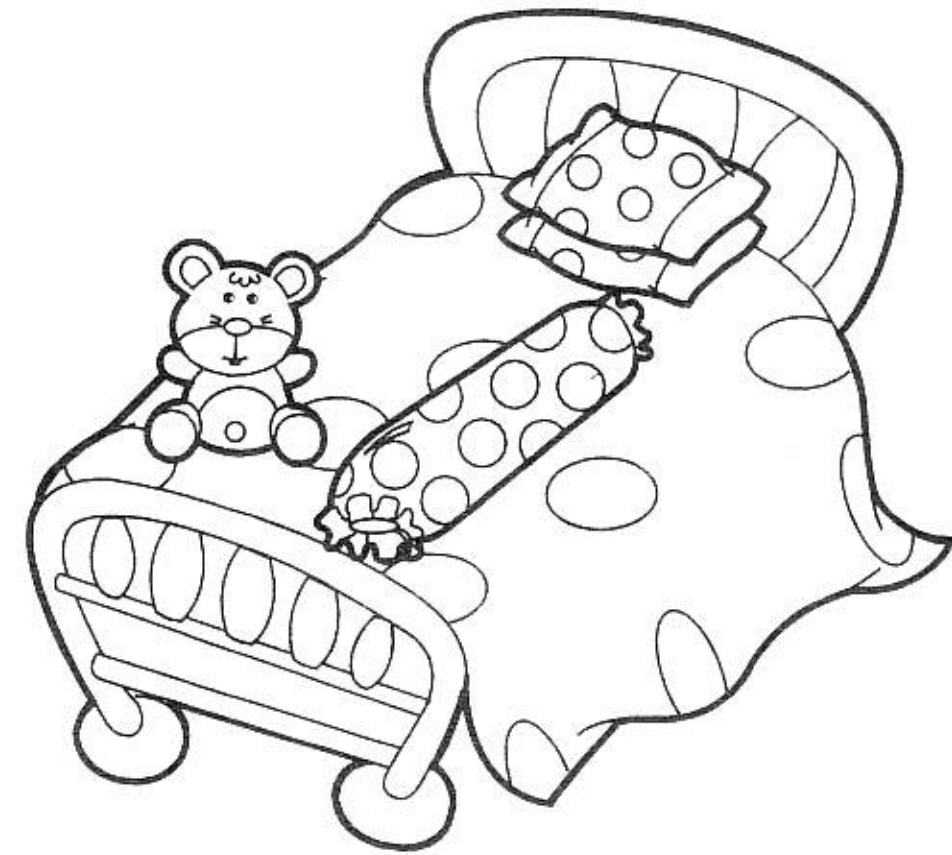

ก



ข

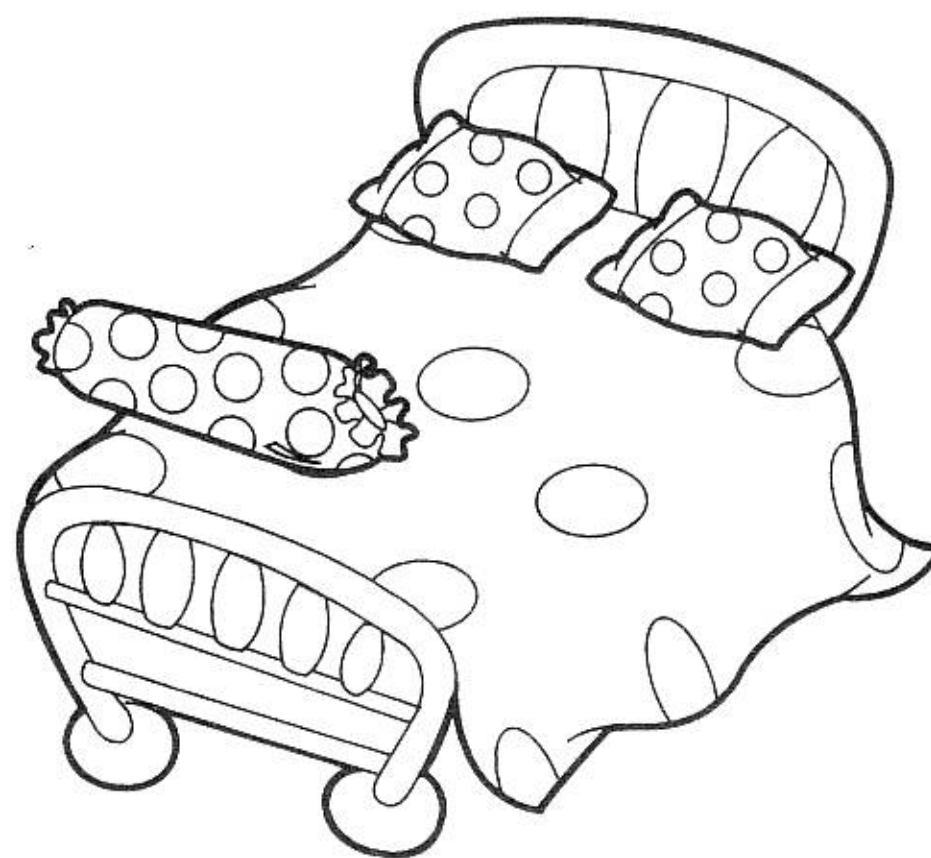

ค

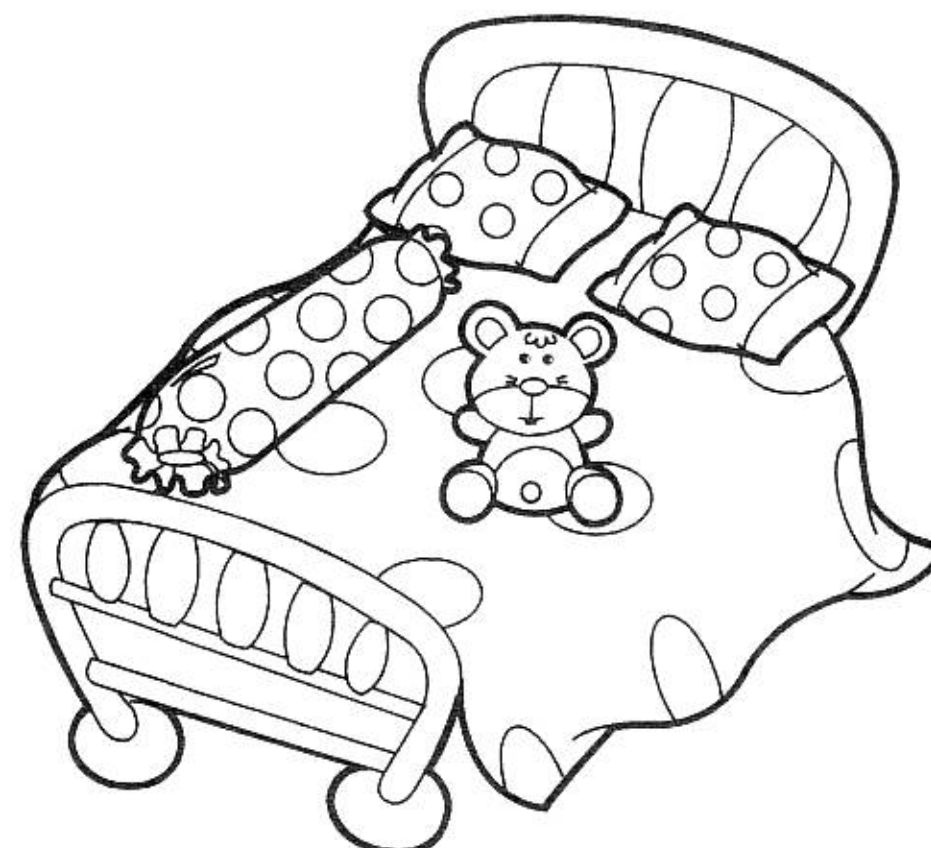

ง

13 ภาพใดมีพื้นที่ว่างบนโต๊ะทำงานเท่ากับภาพแรก

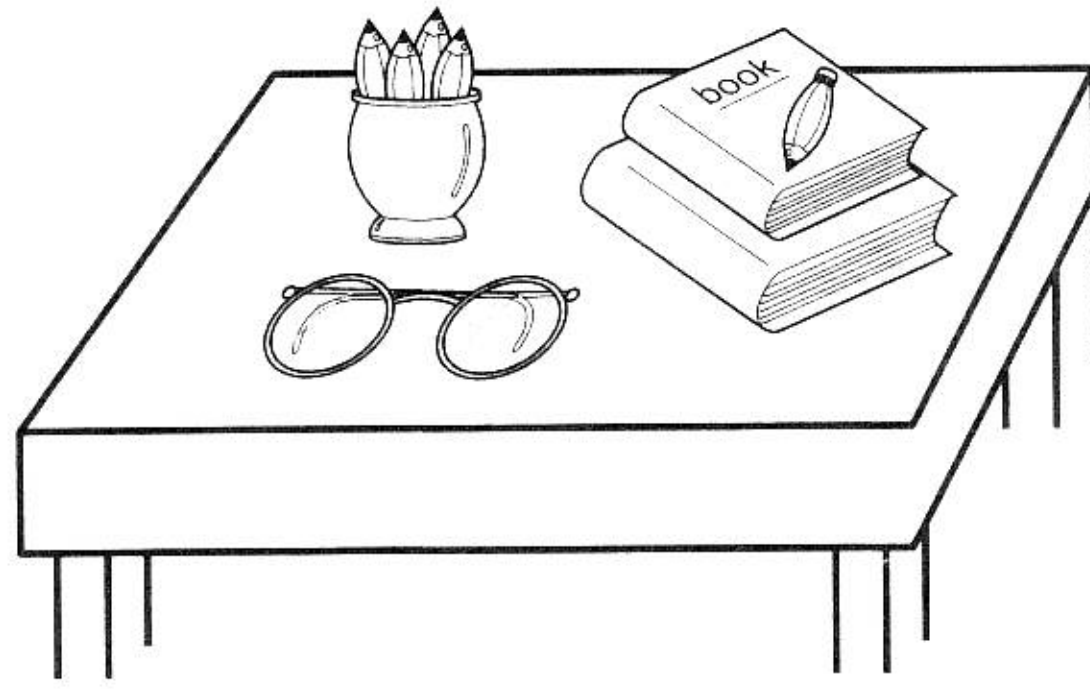
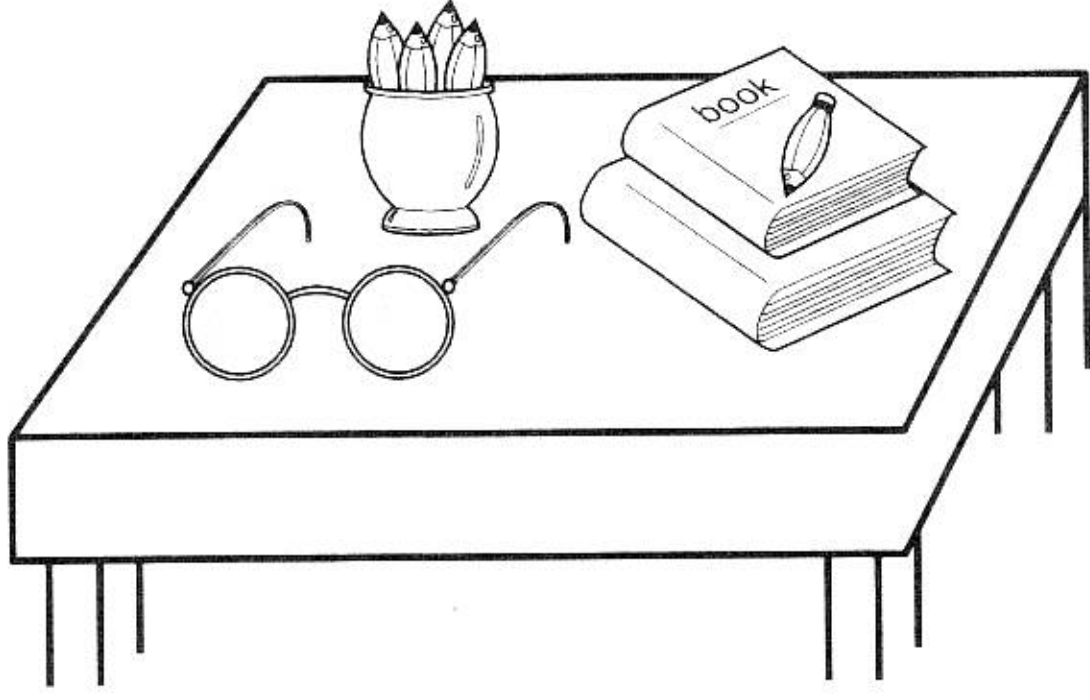

ก

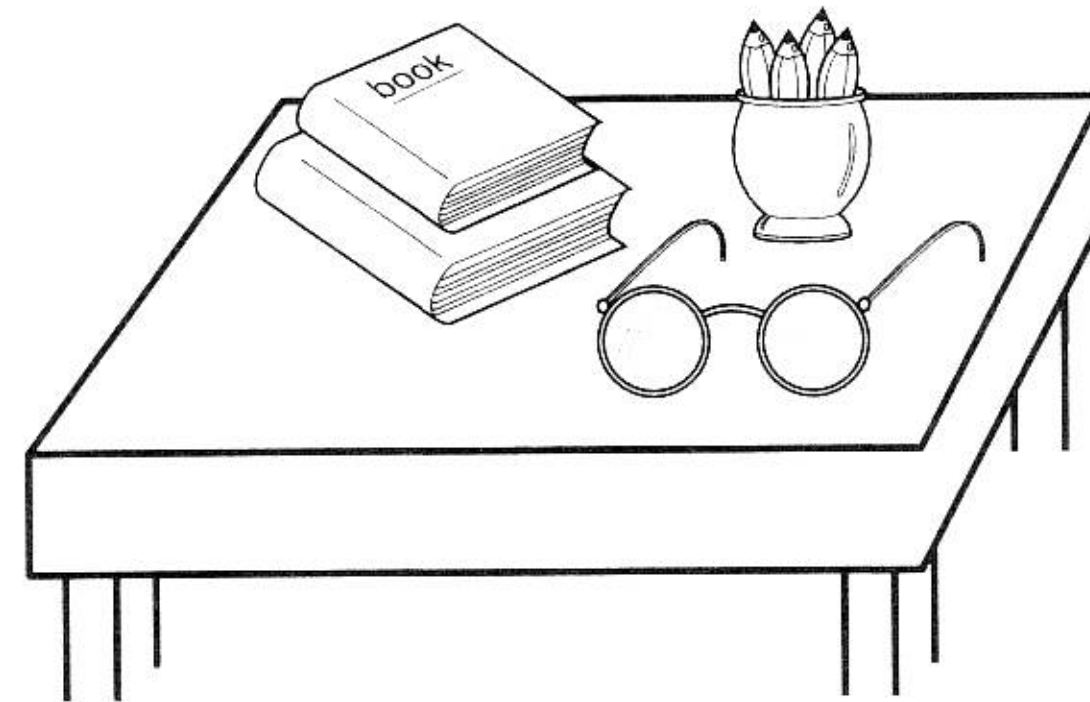

ข

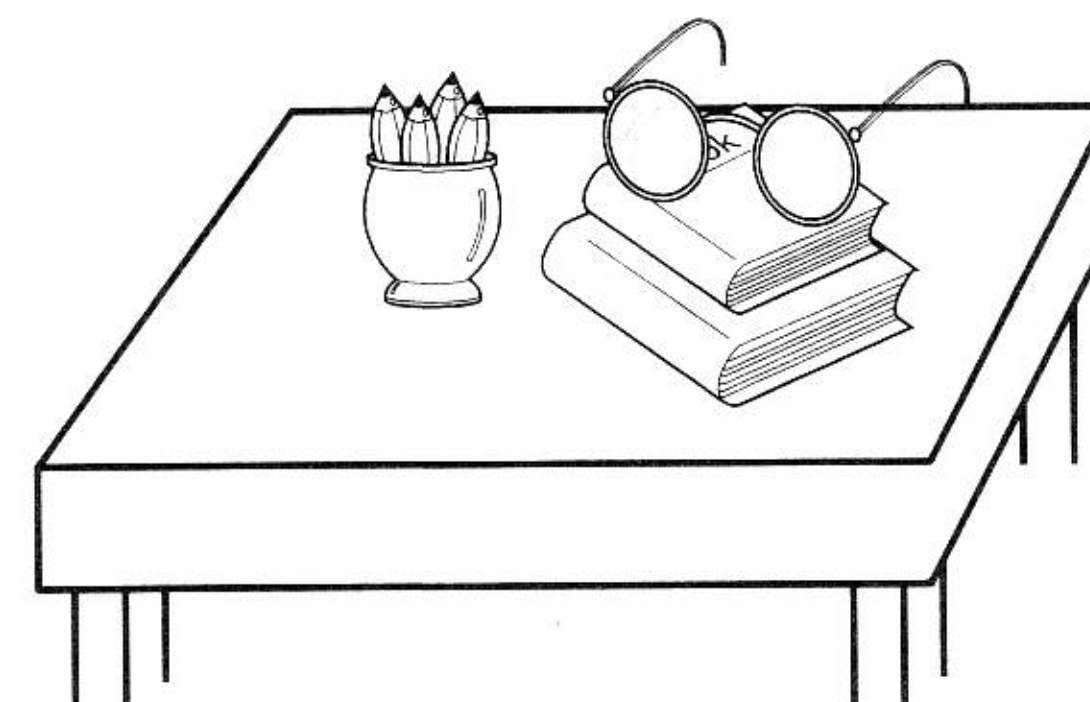

ค

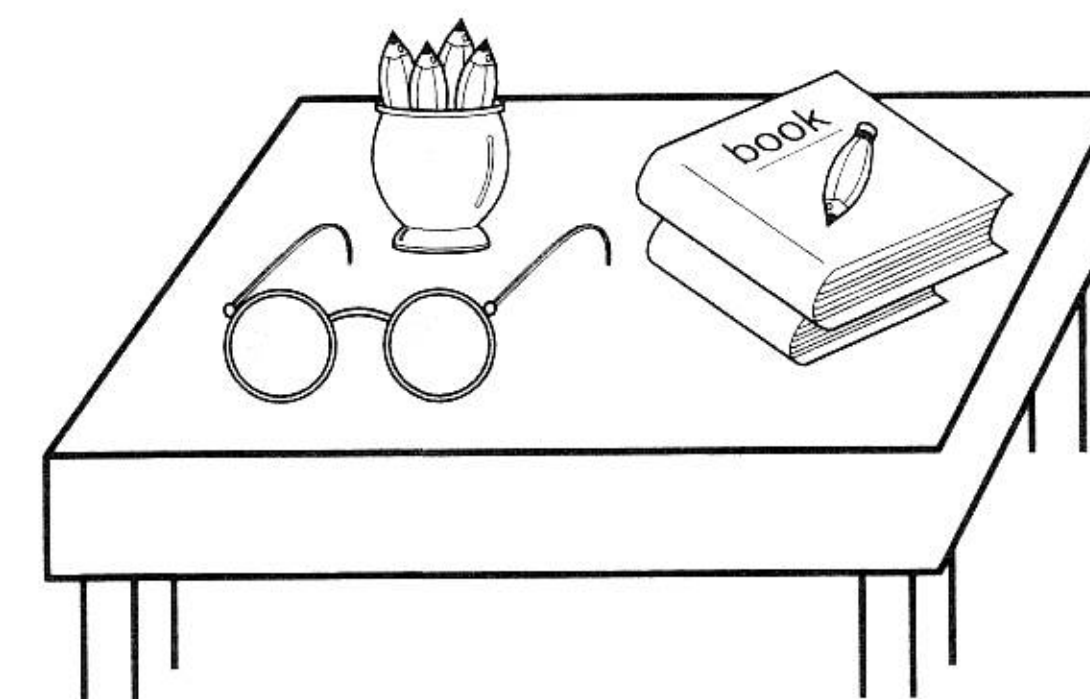

ง

14 ภาพใดมีพื้นที่ว่างในตู้เย็นเท่ากับภาพแรก

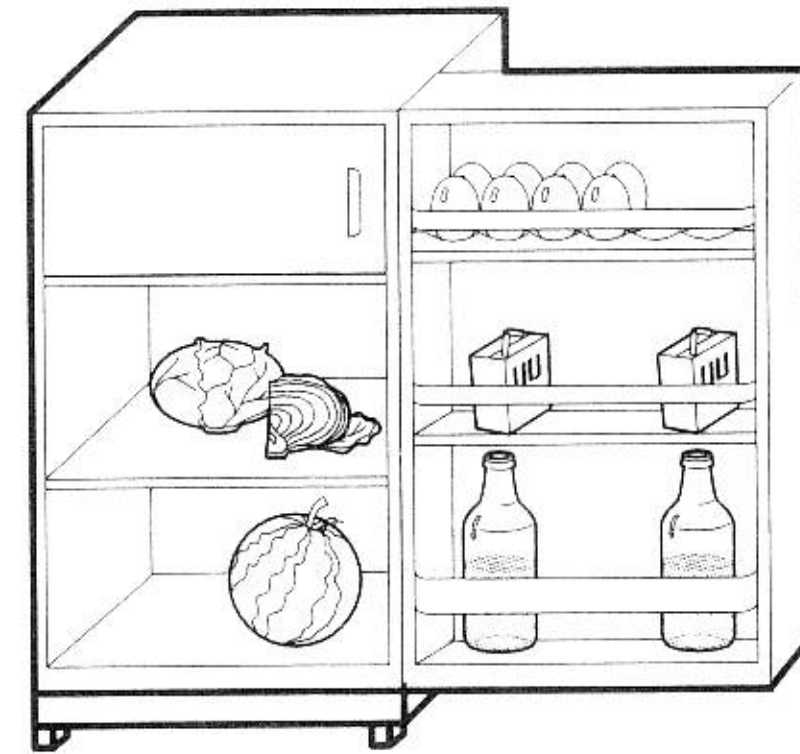
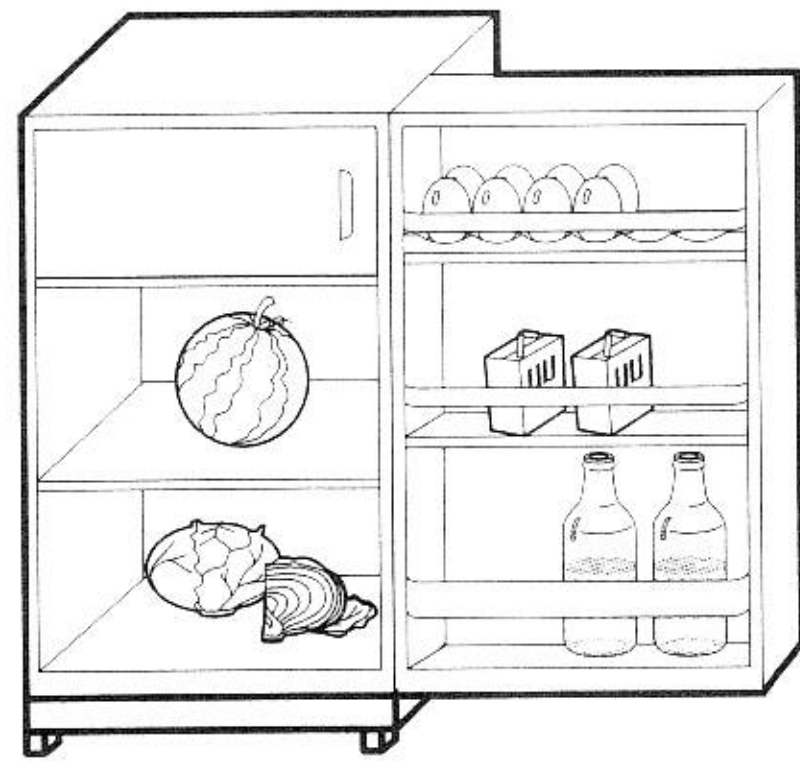

ก

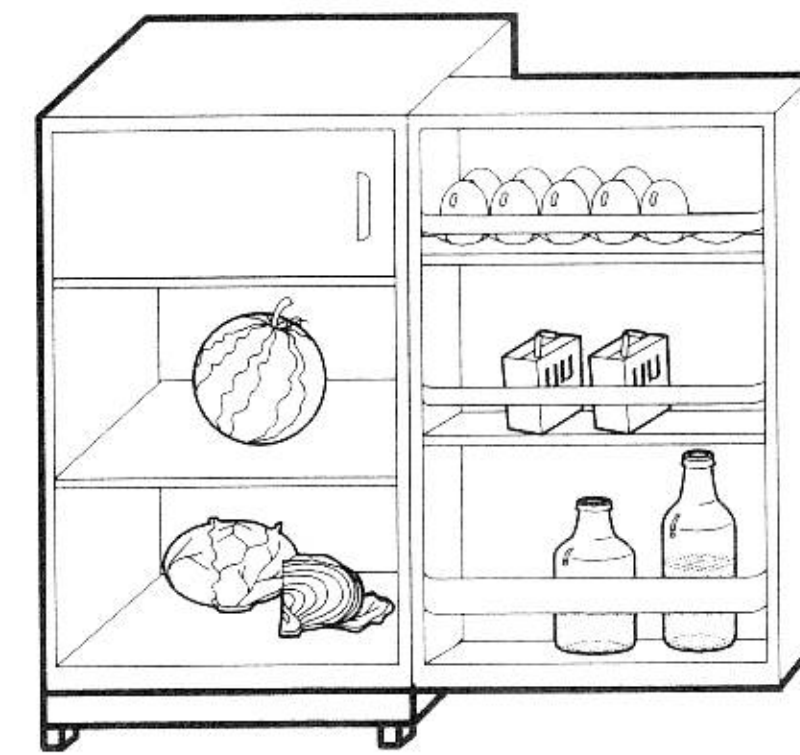

ข

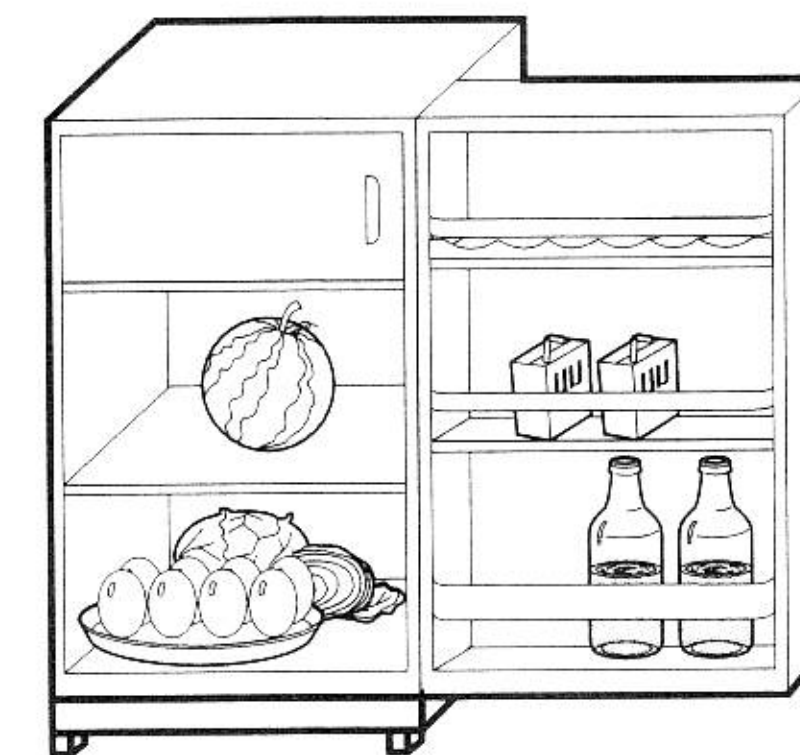

ค

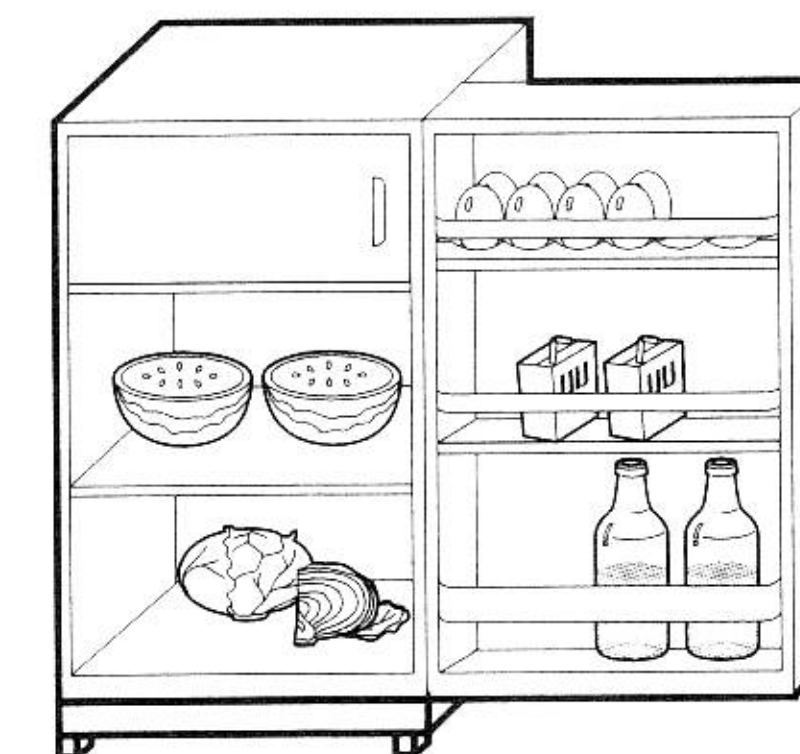

ง

15 ภาพใดมีพื้นที่ว่างบนเรือเท่ากับภาพแรก

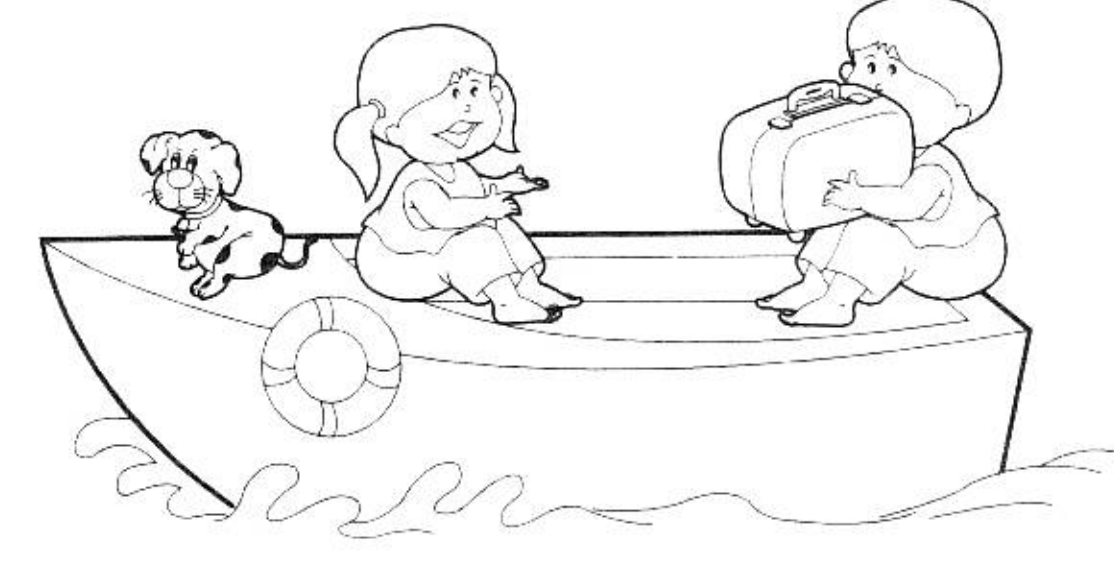
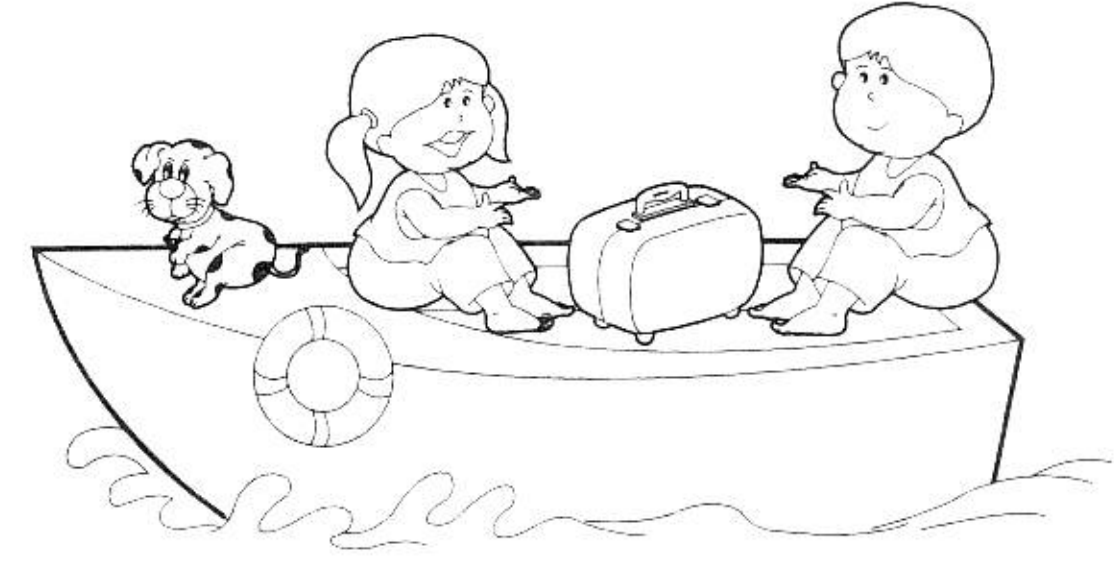

ก



ข

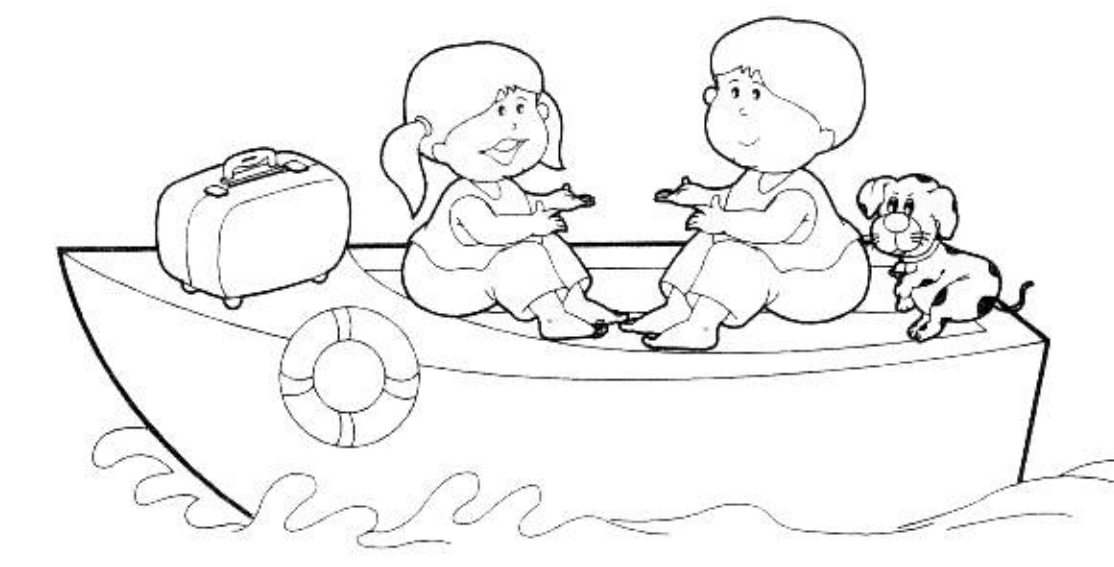

ค

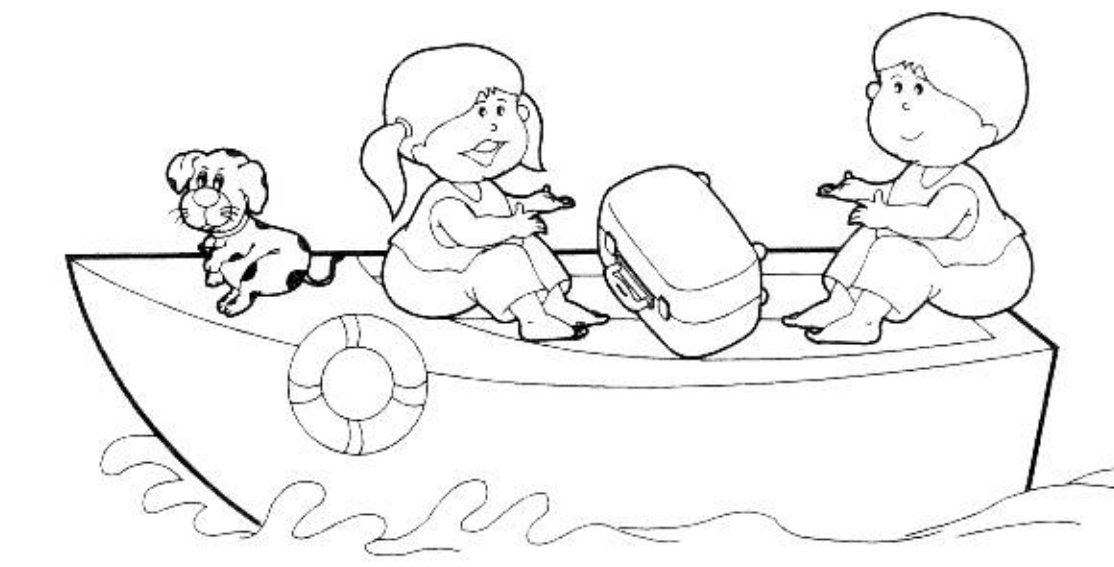

ง

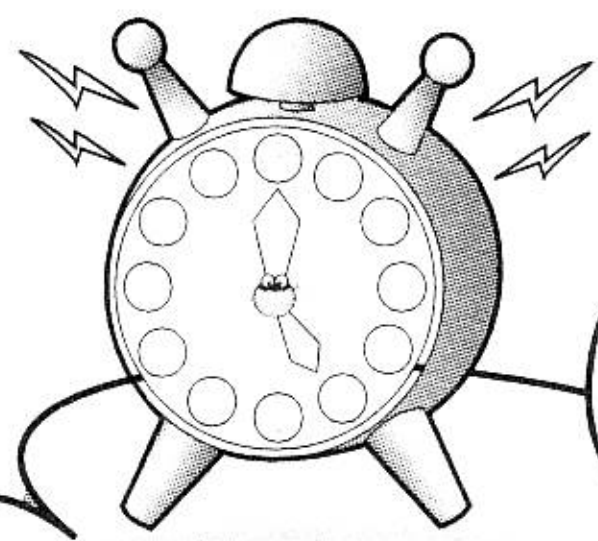

# ตอนที่ 5

## ความรู้เรื่องเวลา และนาฬิกา

- การอ่านเวลาจากนาฬิกา

12 ข้อ

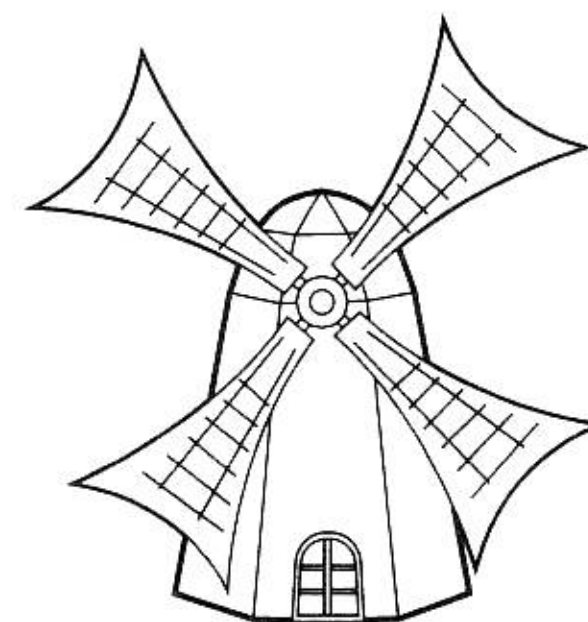

จงขีด ✓ ข้อที่นาฬิกา บอกเวลาตามภาพที่กำหนดในช่องแรก

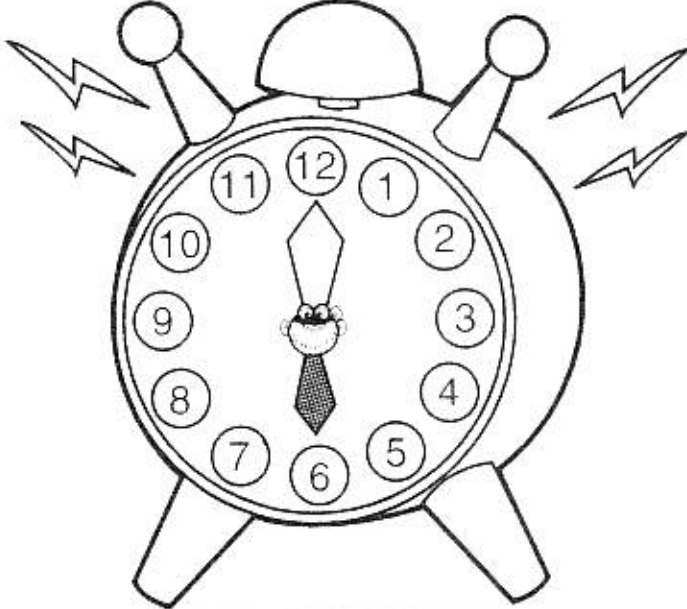
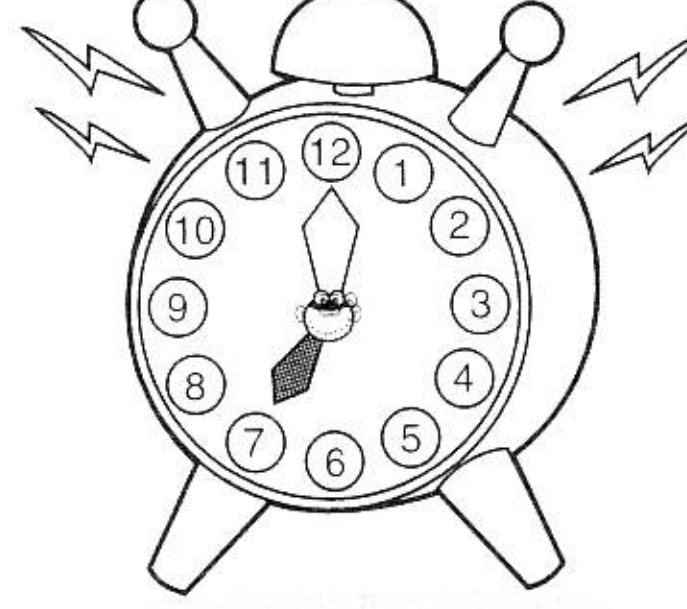
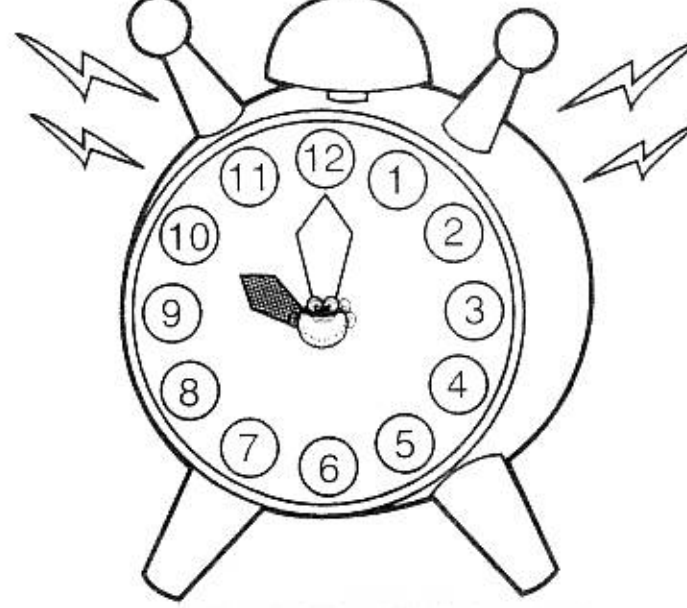
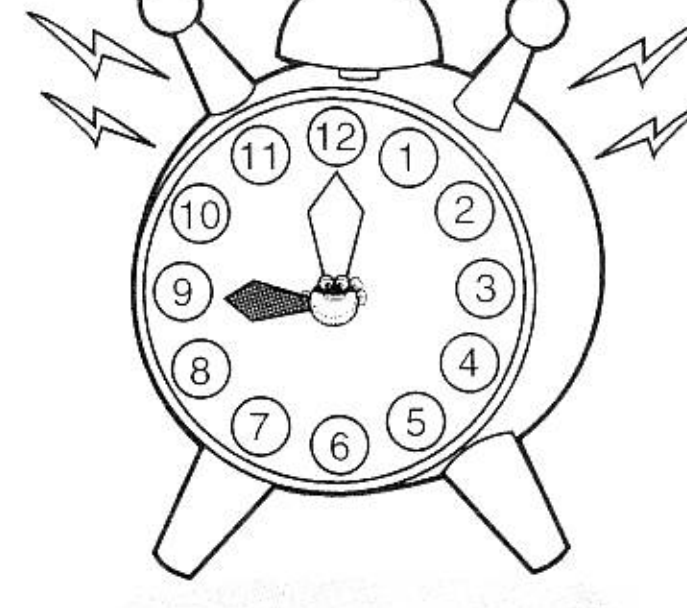
<b>1</b> เราควรตื่นนอนเวลาใด 	 ก	 ข
	 ค	 ง

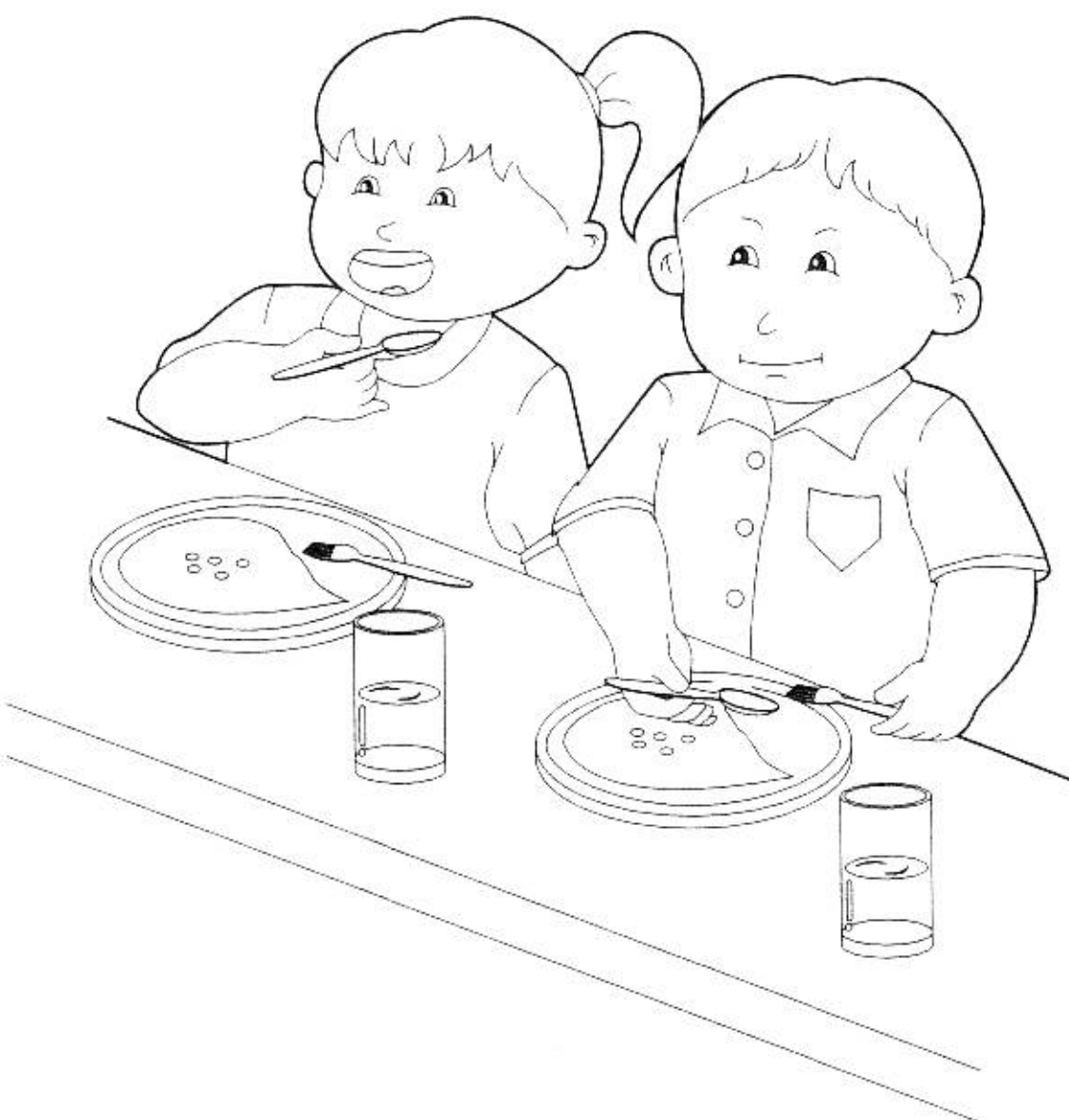
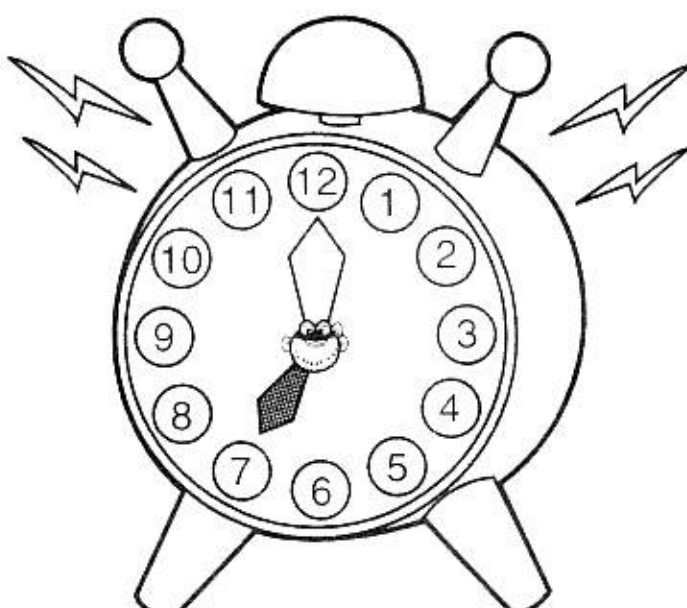
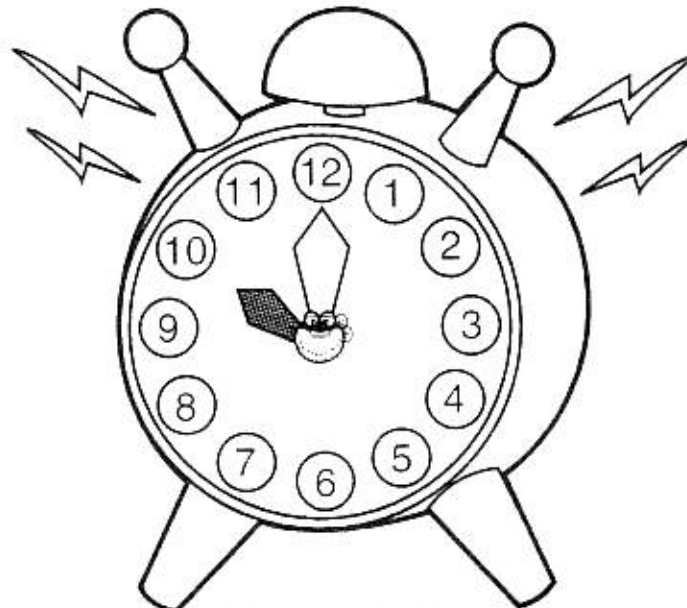
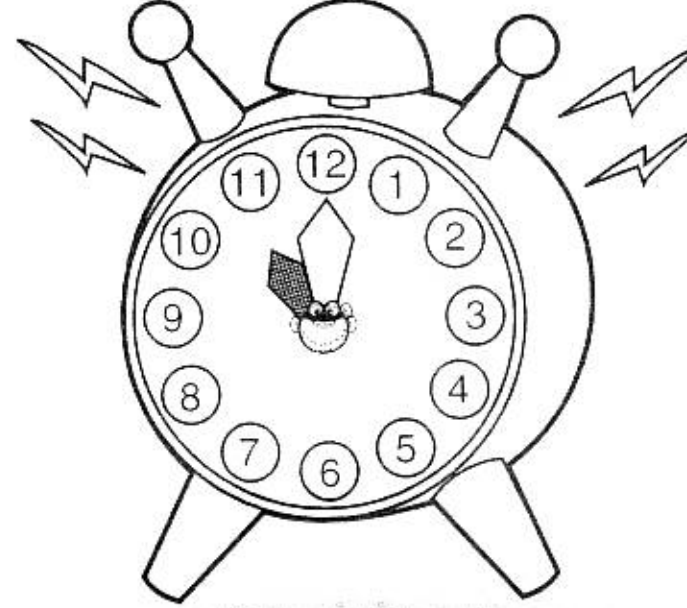
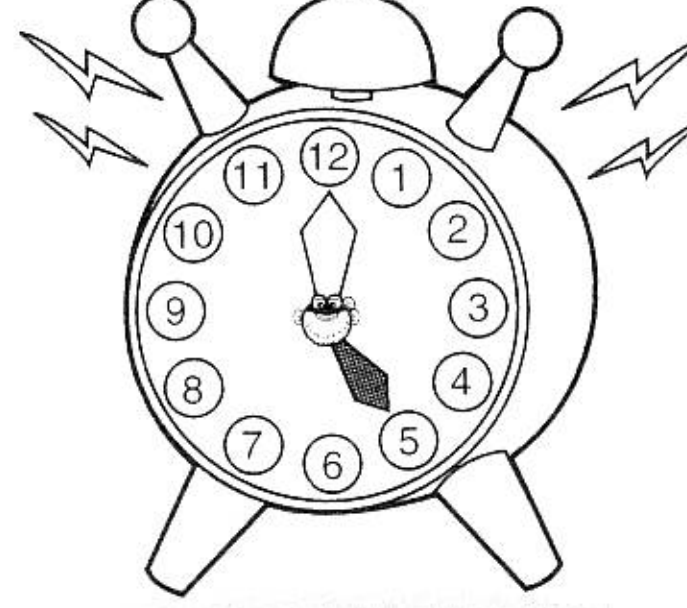
<b>2</b> นักเรียนรับประทานอาหารเช้าที่โรงเรียนเวลาใด 	 ก	 ข
	 ค	 ง

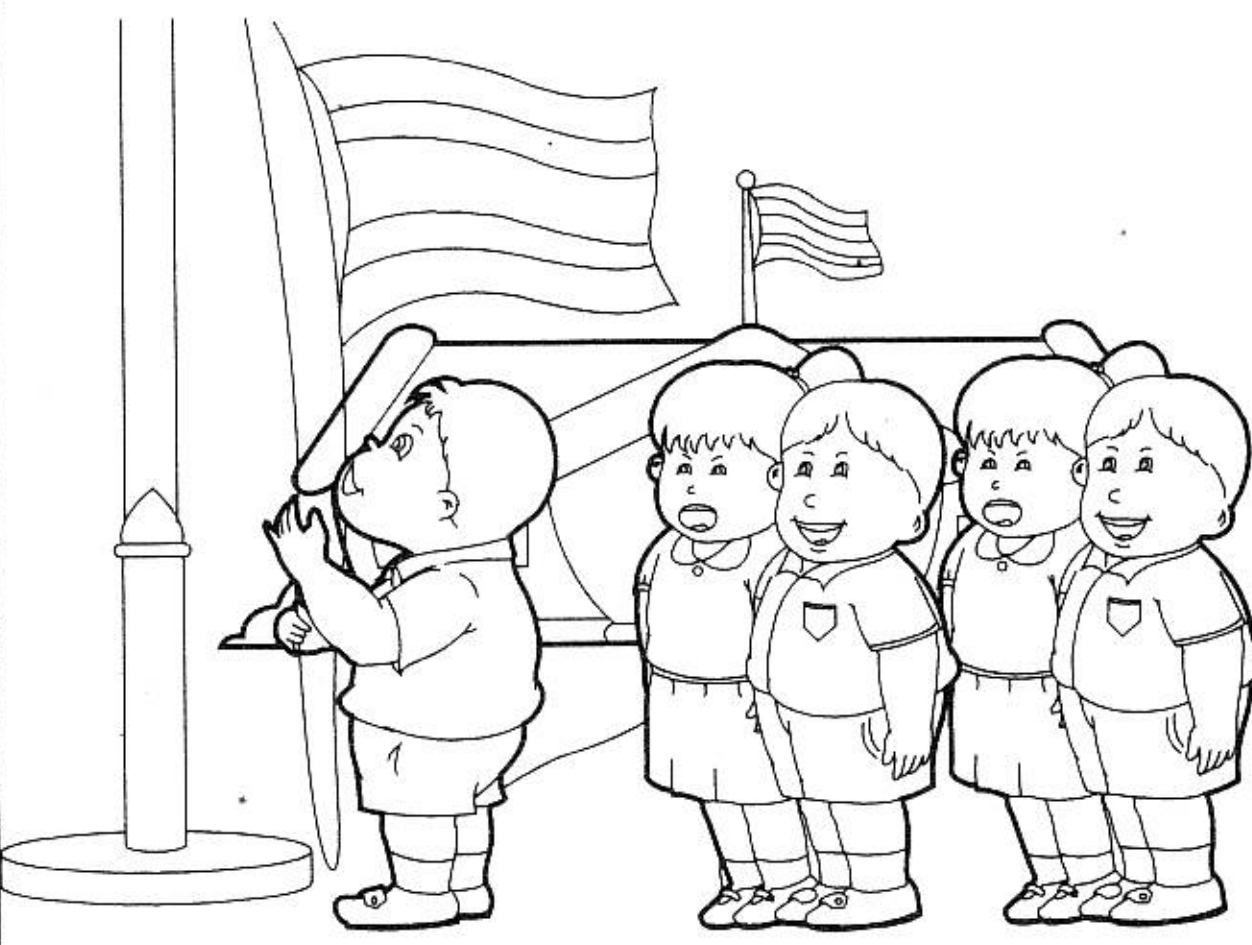
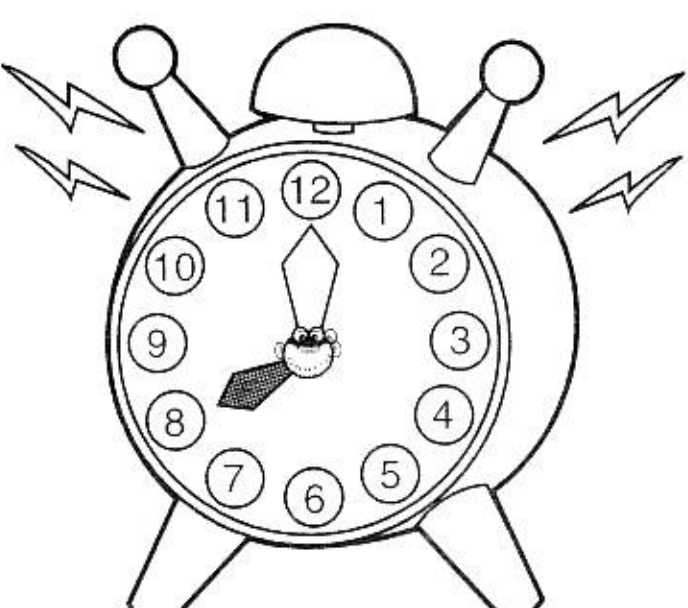
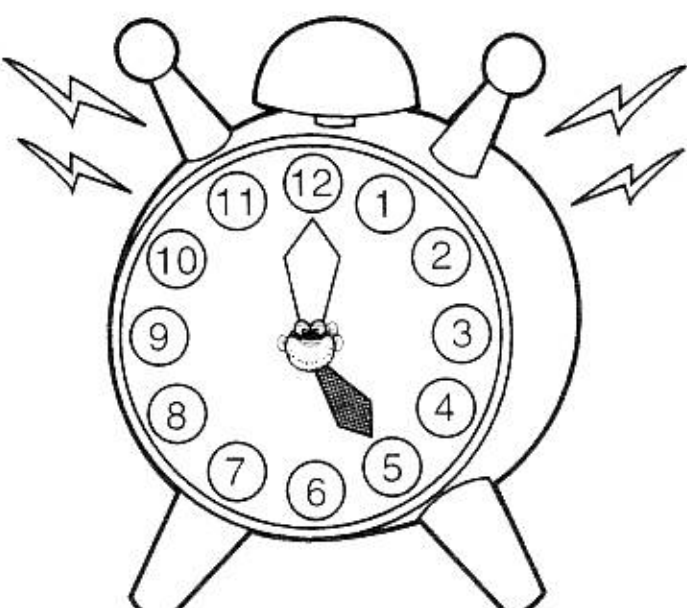
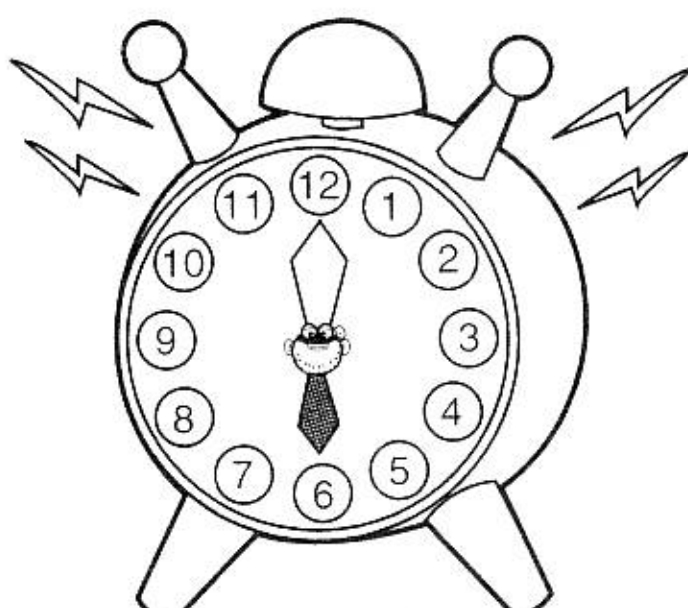
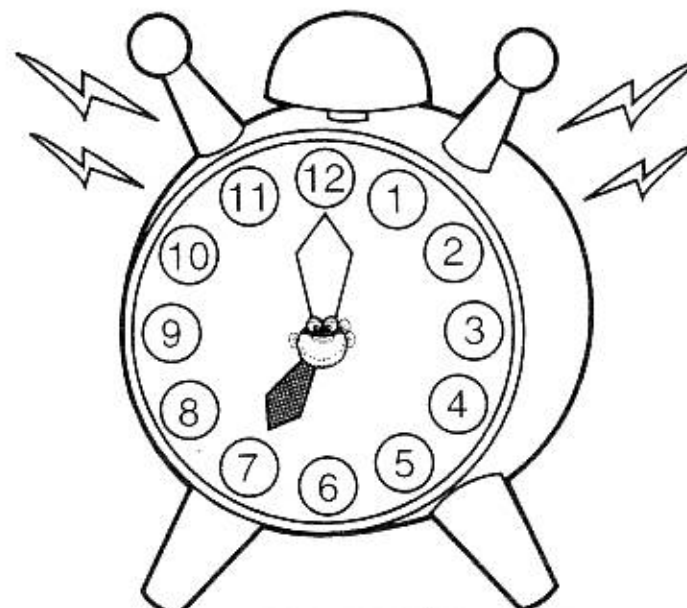
<b>3</b> นักเรียนเคารพธงชาติตอนเช้าเวลาใด 	 ก	 ข
	 ค	 ง

4

นักเรียนนอนกลางวัน  
ที่โรงเรียนในเวลาใด

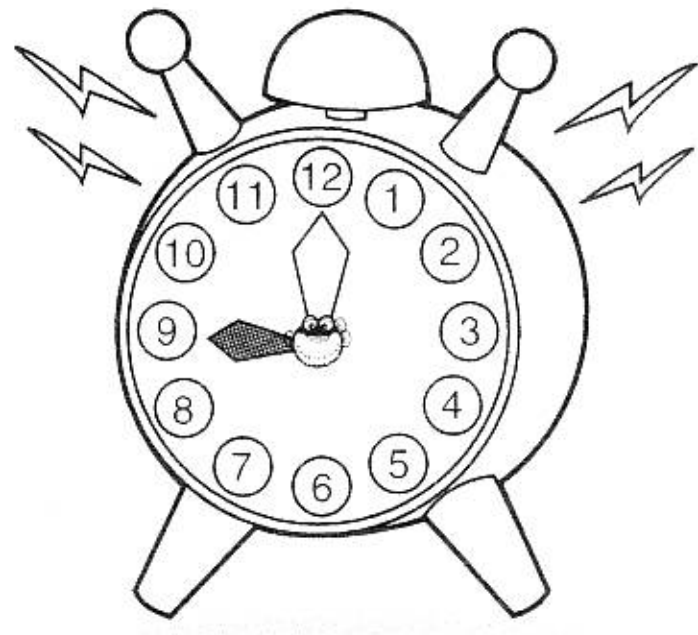

ก

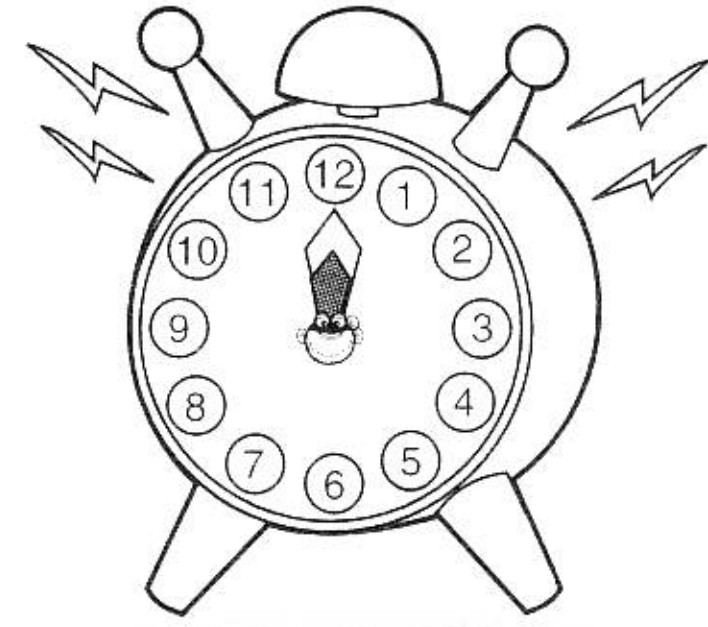

ข

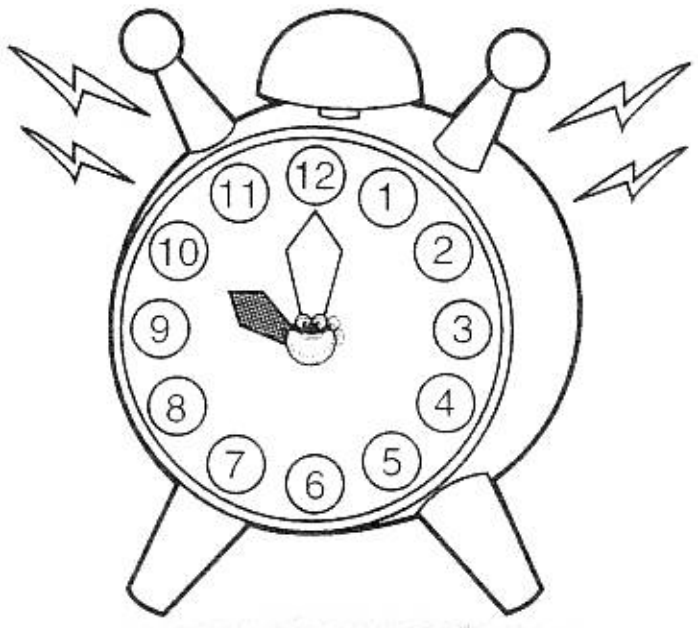

ค



ง

5

นักเรียนรับประทาน  
อาหารเข้าเวลาใด

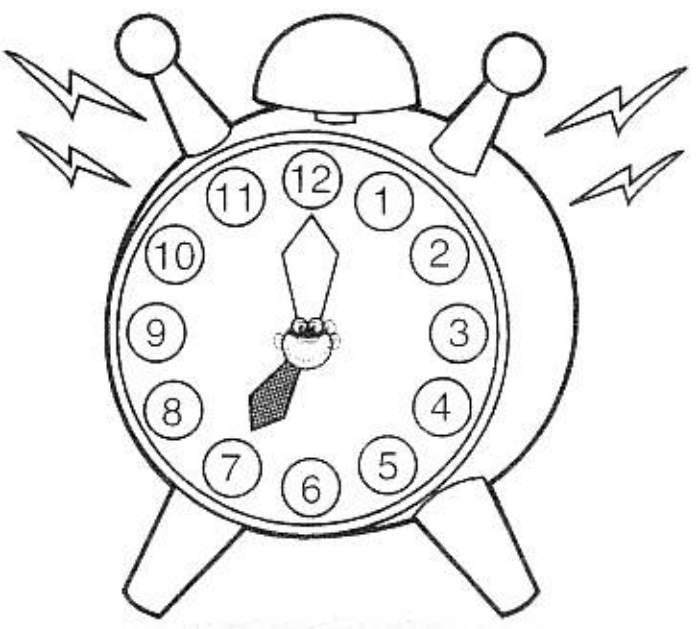

ก

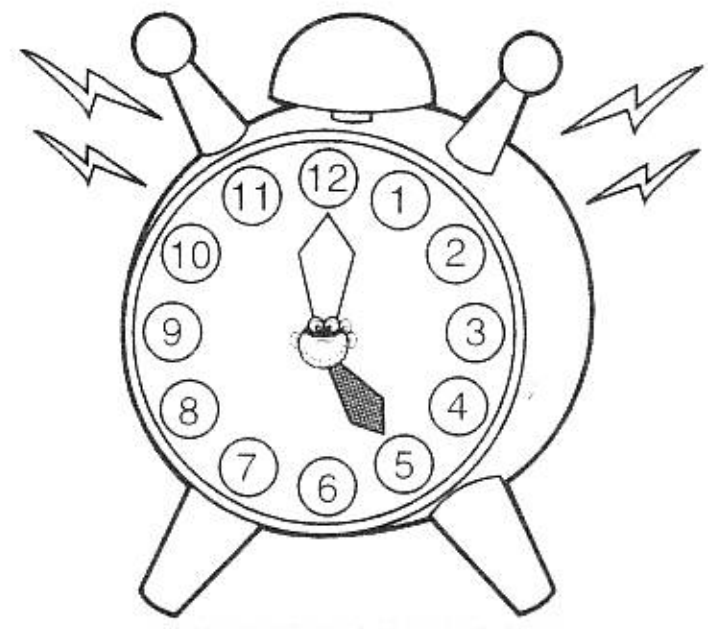

ข

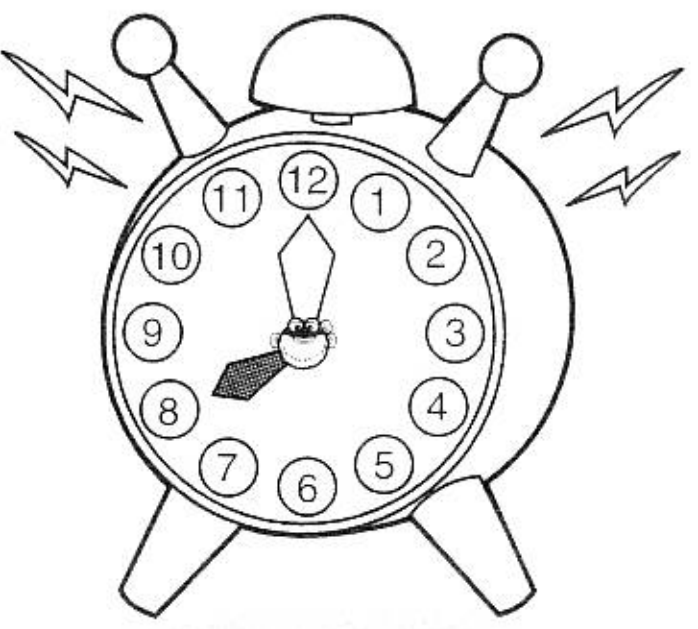

ค

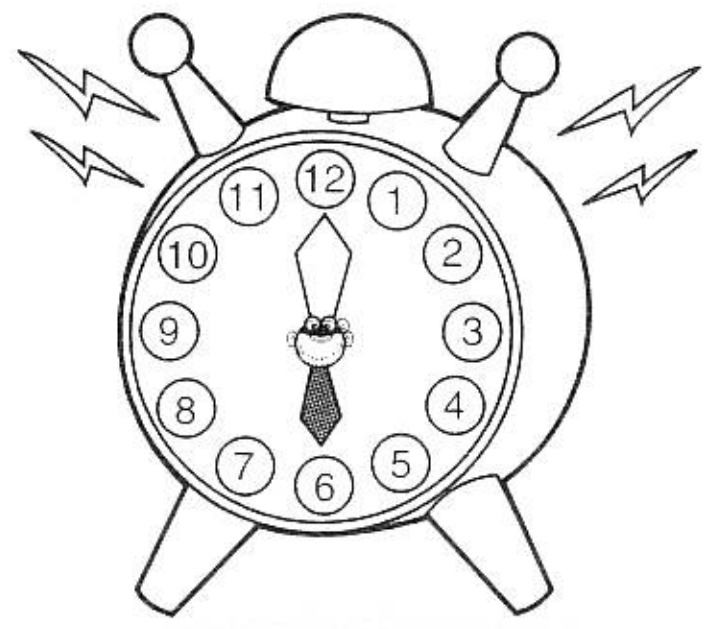

ง

6

นักเรียนเข้านอนเวลาใด

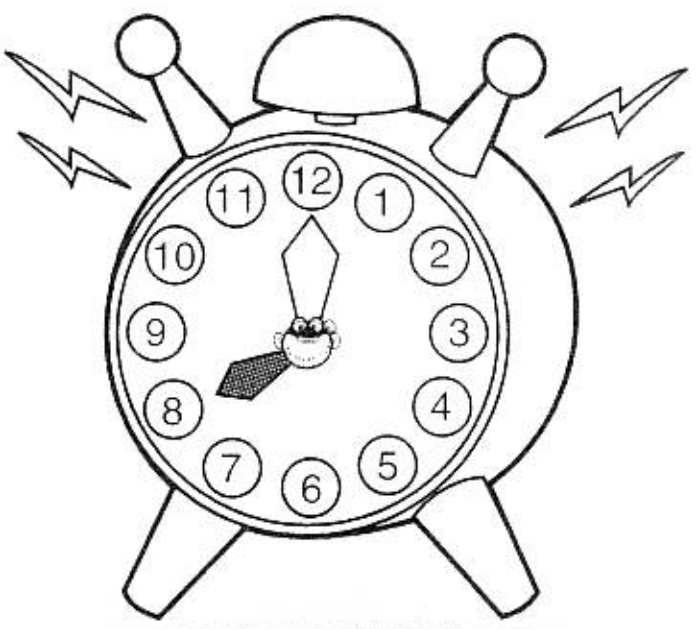

ก

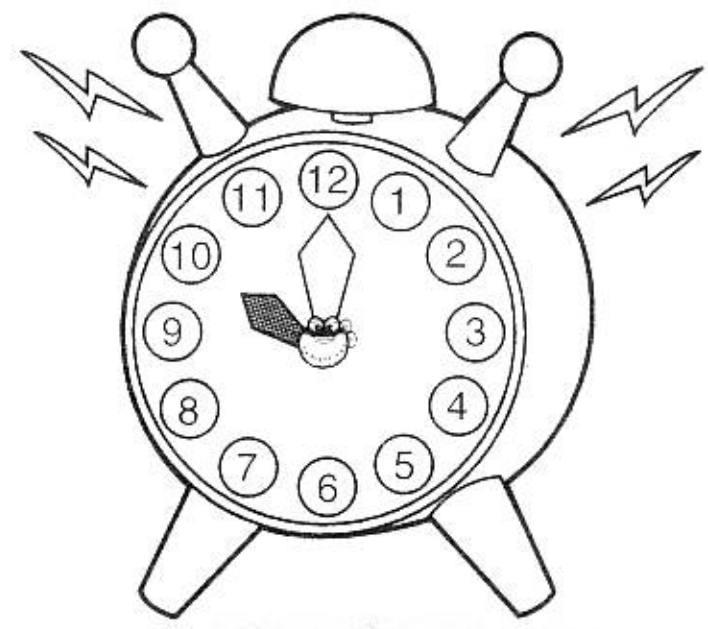

ข

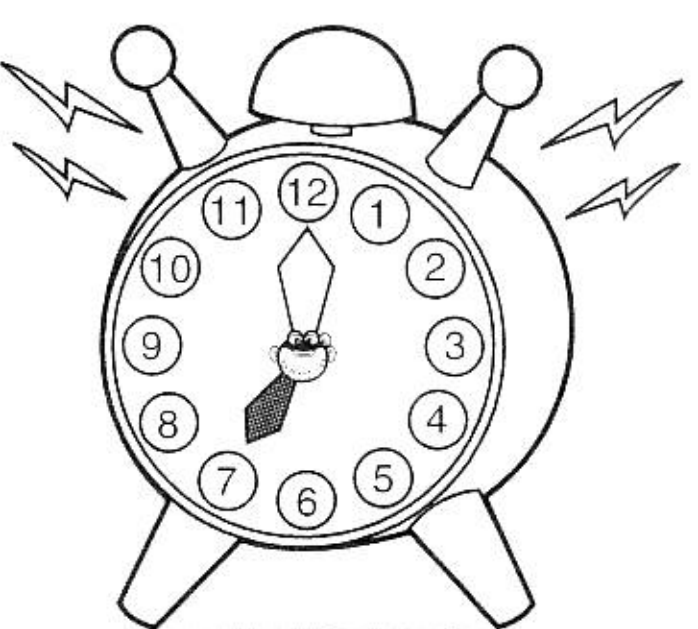

ค

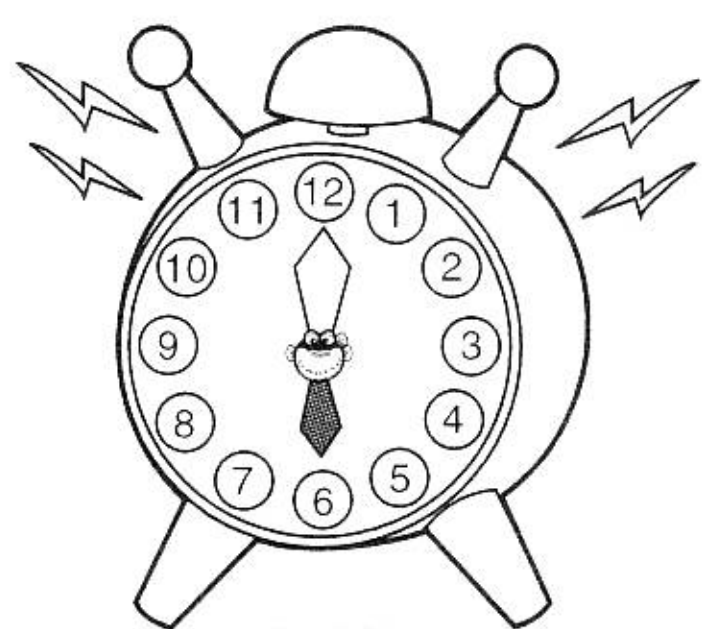

ง

7 นักเรียนดื่มนมที่โรงเรียน  
เวลาใด

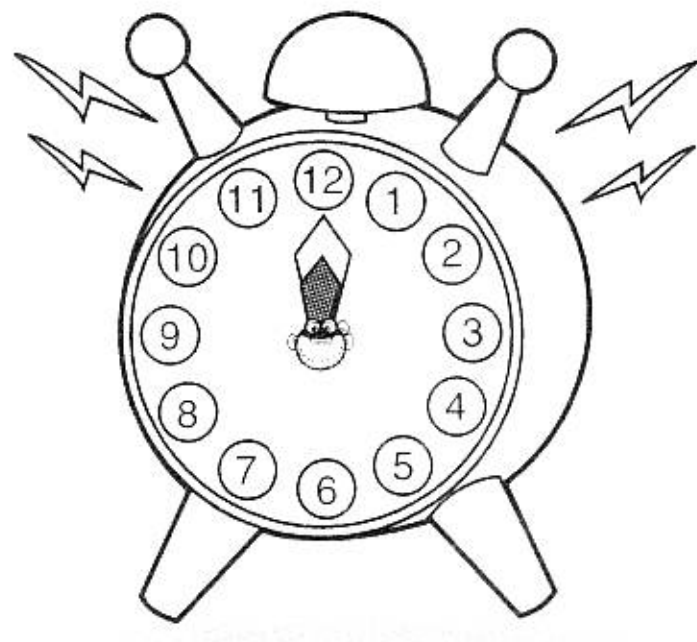

ก

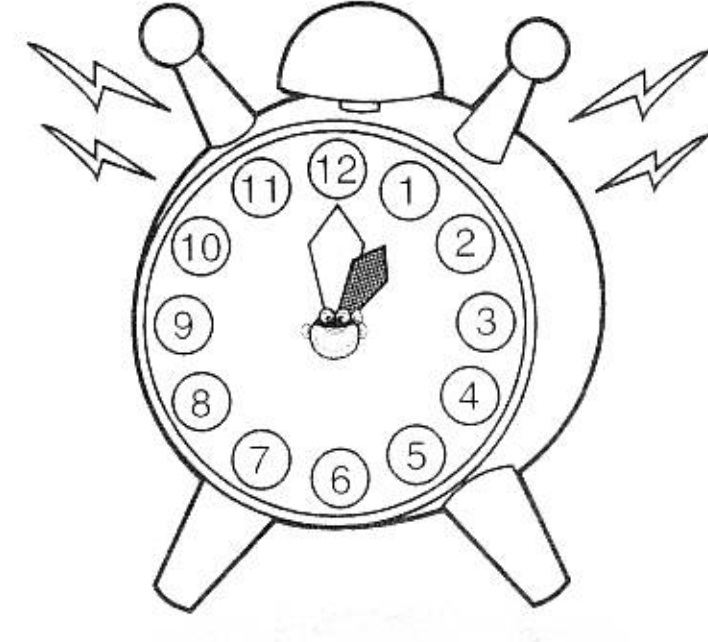

ข

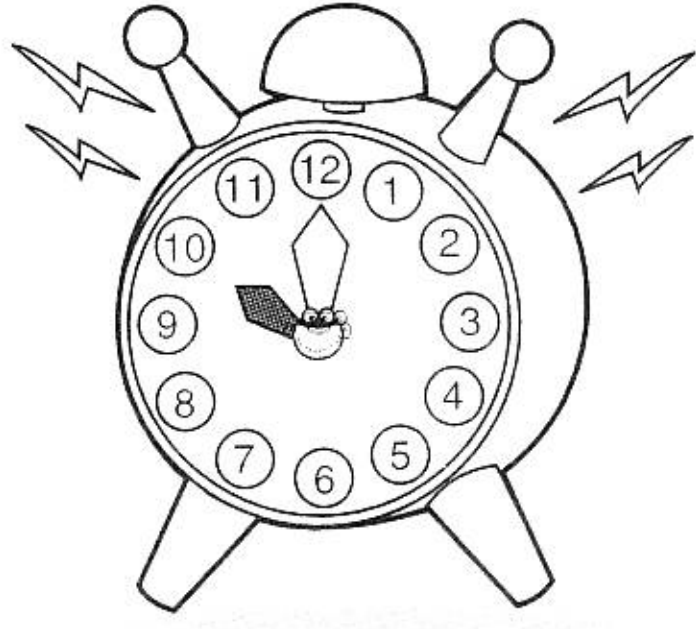

ค

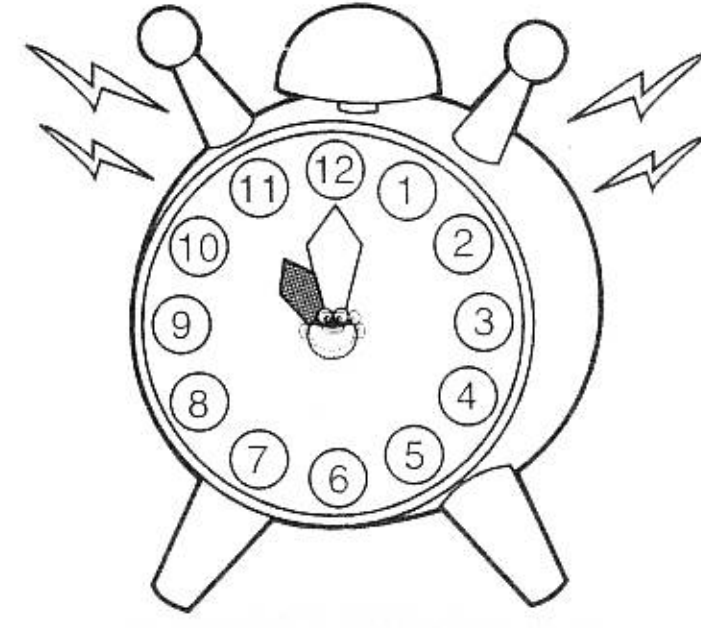

ง

8 เราเชิญธงชาติลงจากเสา  
ในตอนเย็นเวลาใด

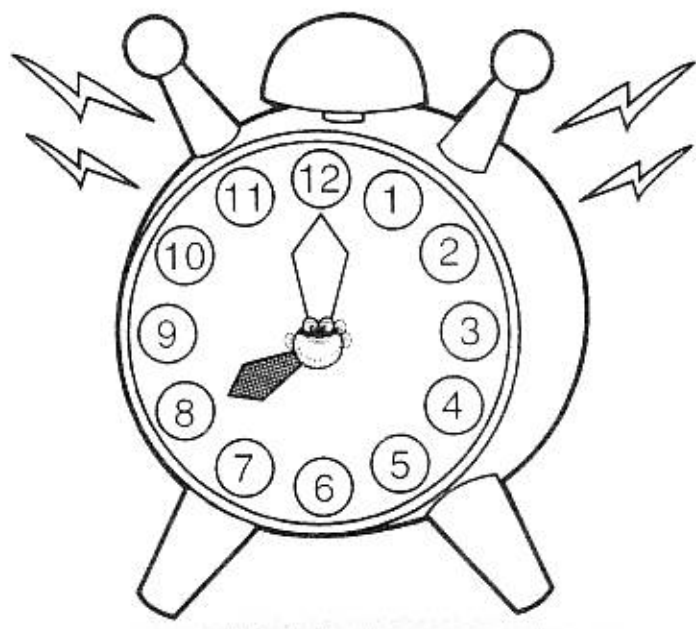

ก

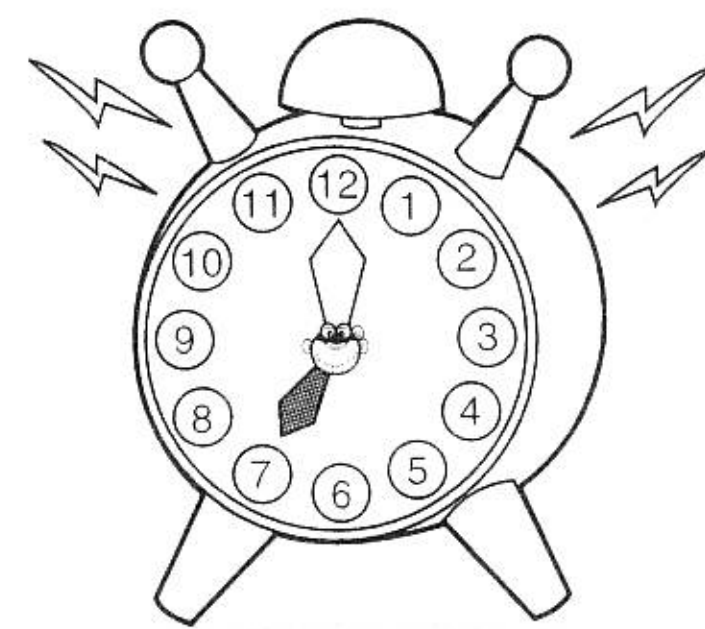

ข

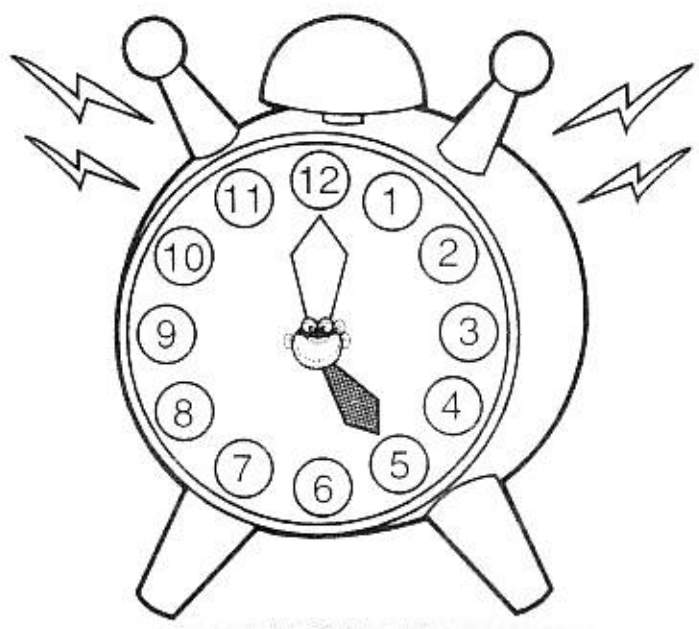

ค

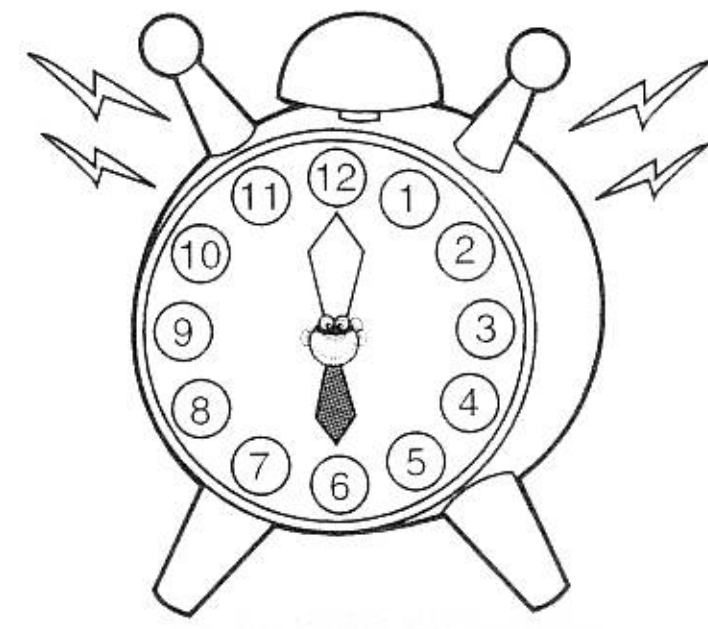

ง

9 นักเรียนทำการบ้าน  
ตอนเย็นเวลาใด

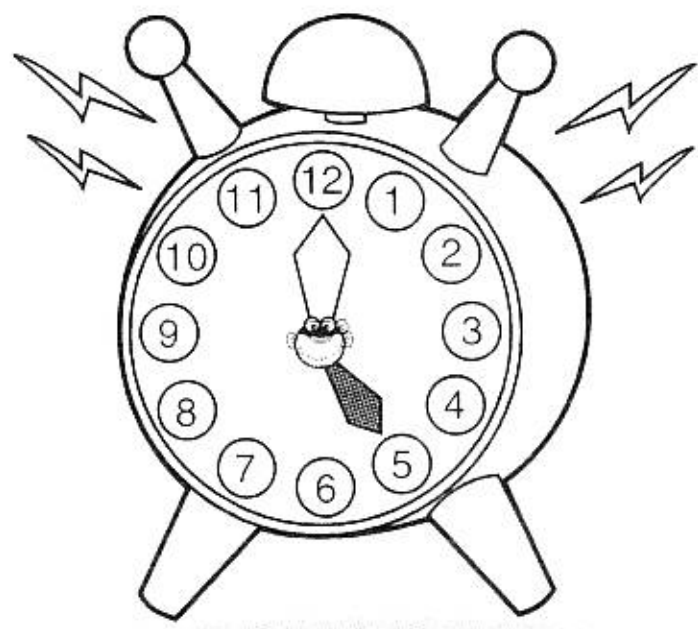

ก

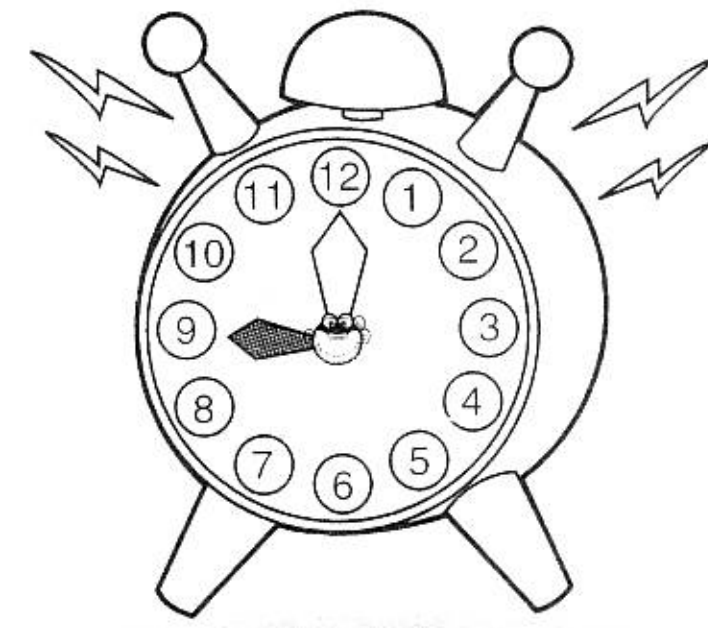

ข

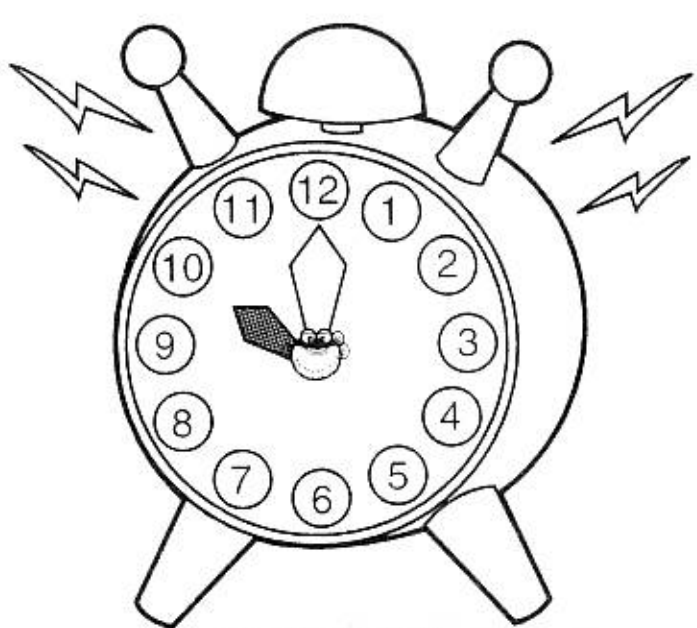

ค

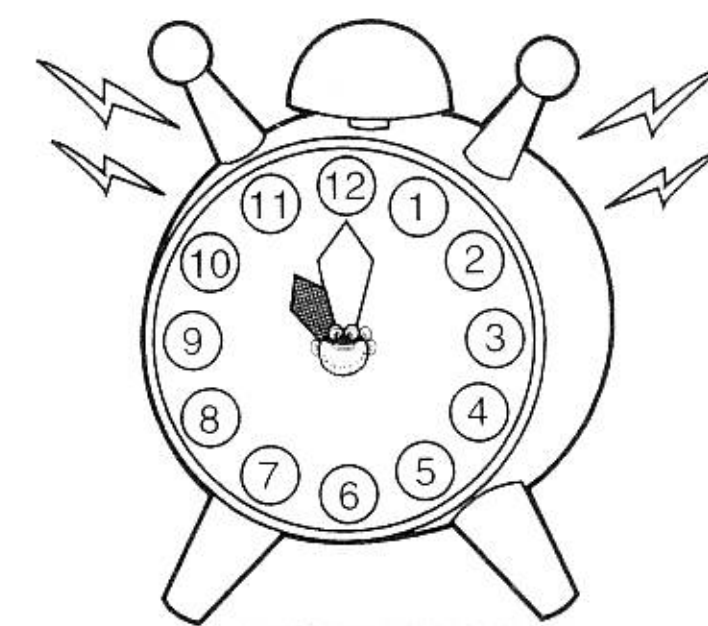

ง

10 เวลาใดที่นักเรียนไป  
โรงเรียนสาย

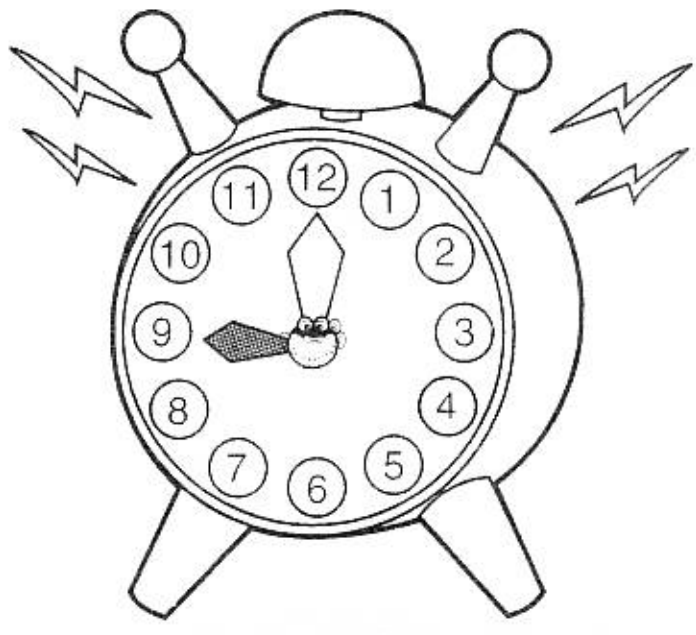
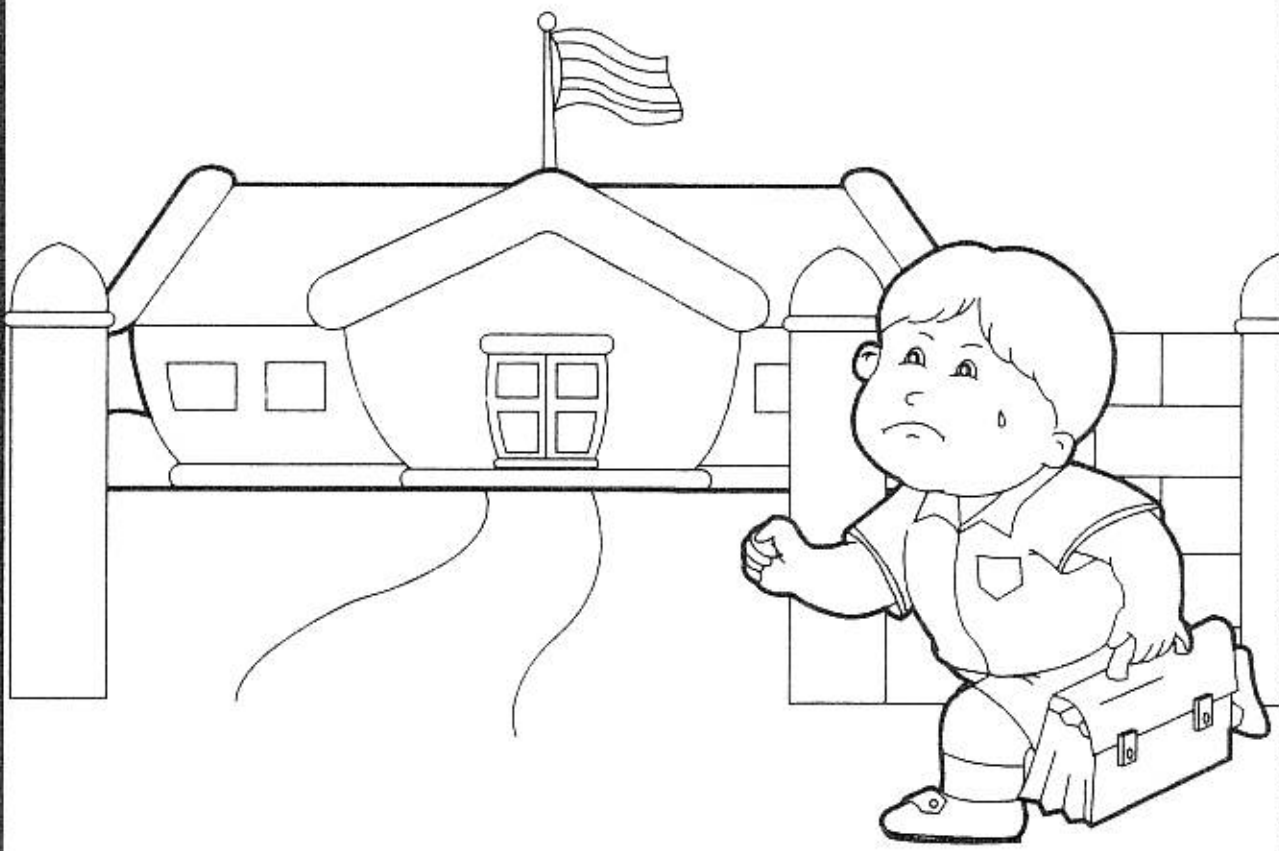

ก

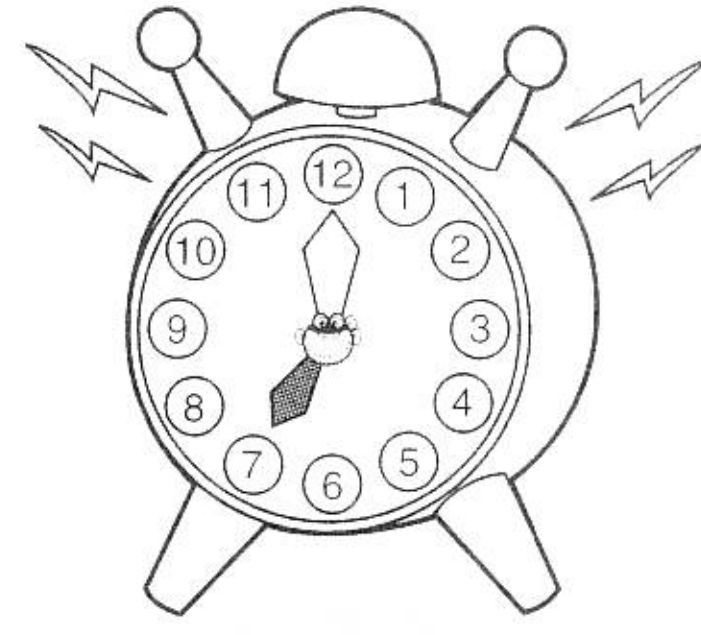

ข

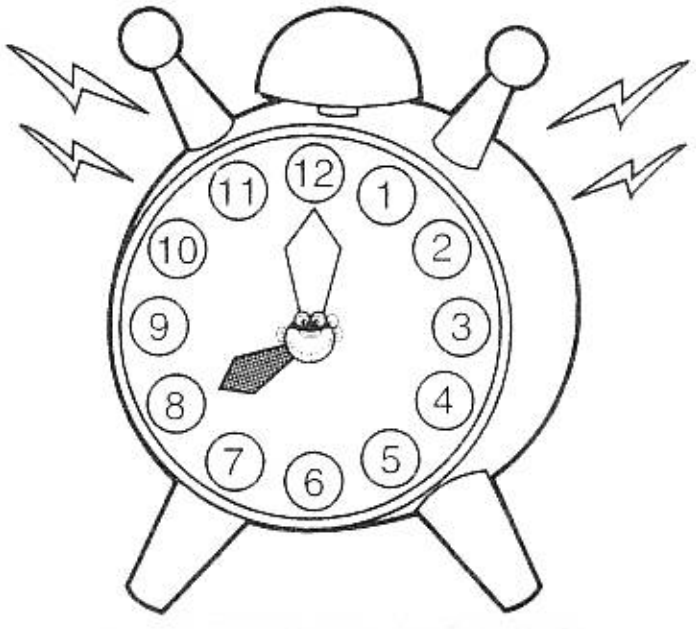

ค

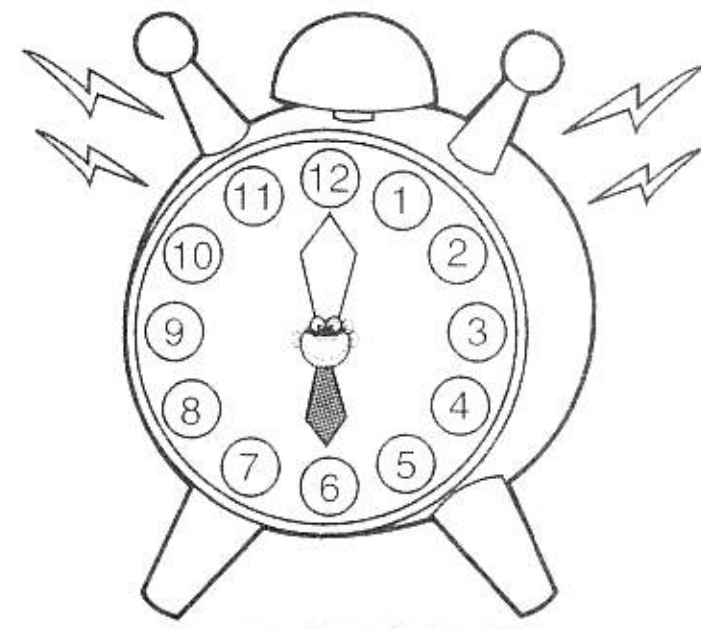

ง

11 โรงเรียนเข้าเวลาใด

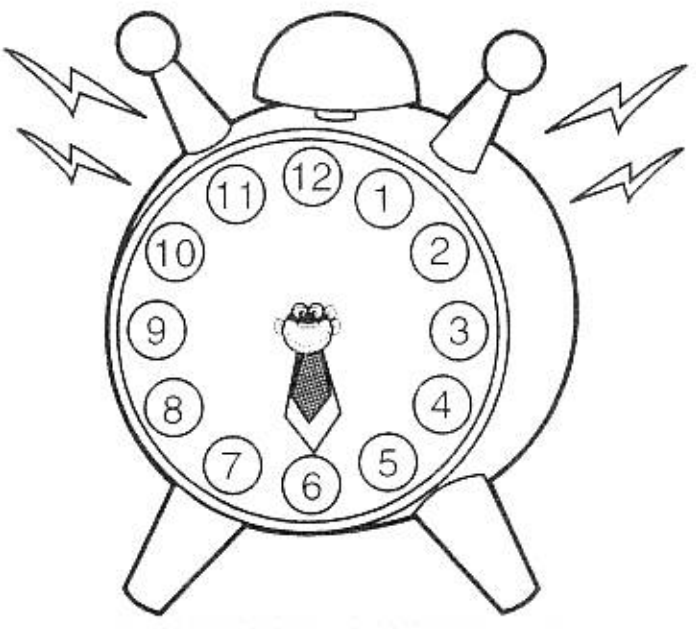
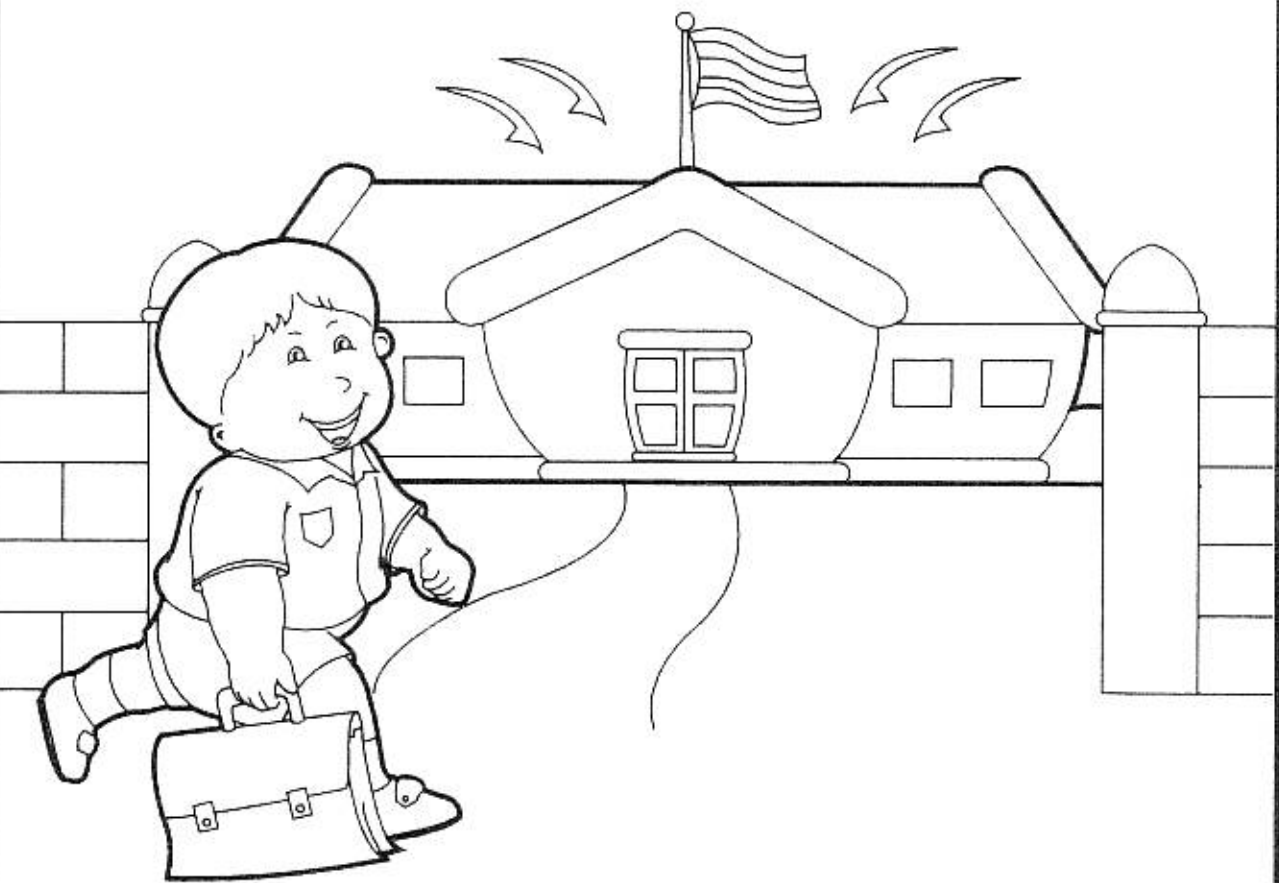

ก

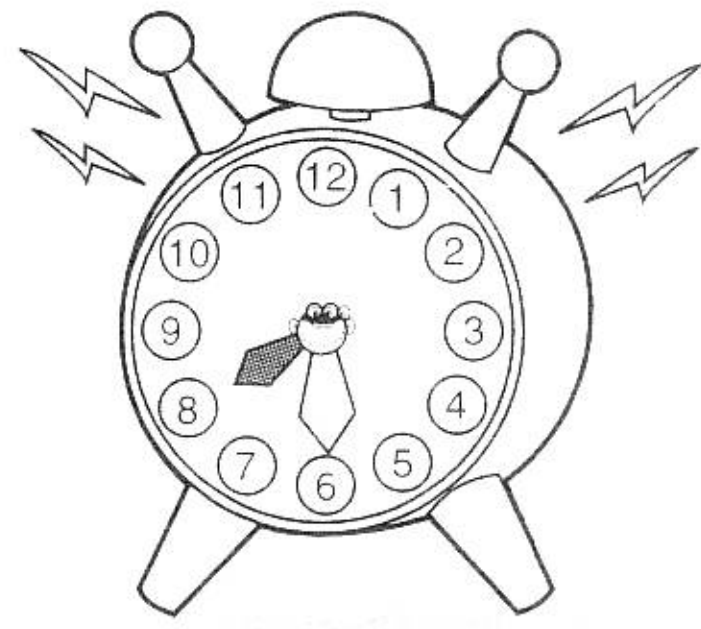

ข

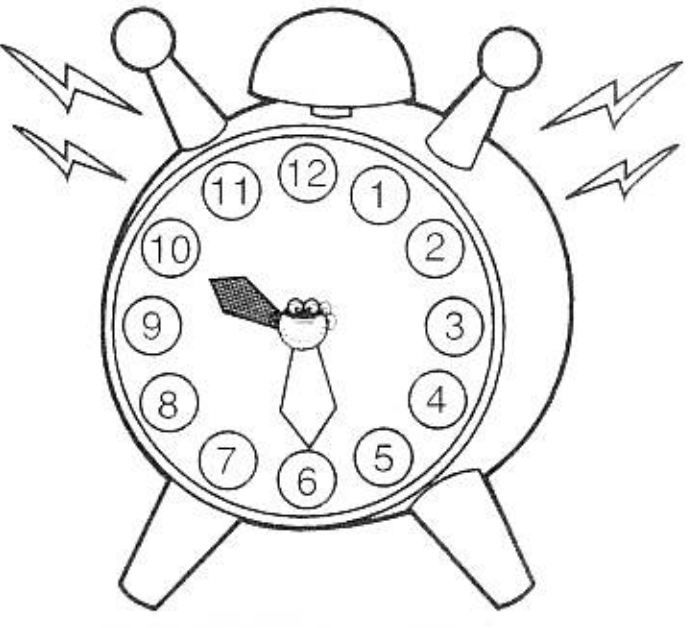

ค

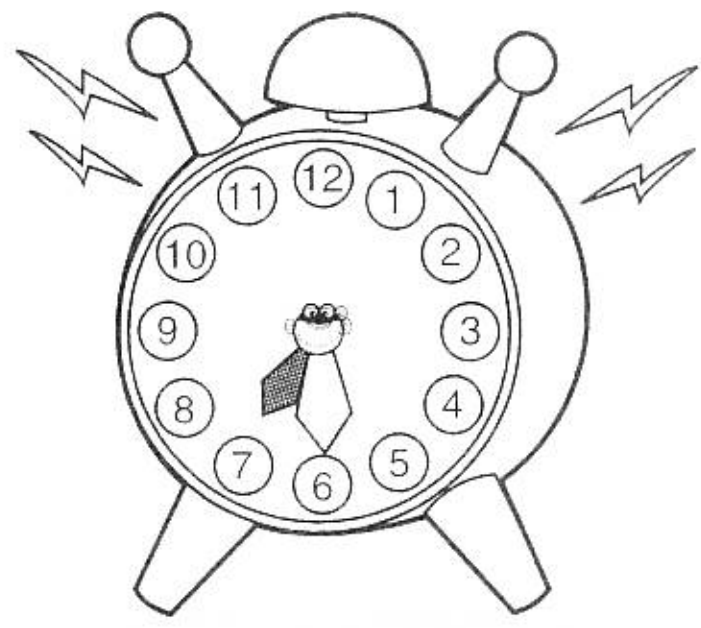

ง

12 โรงเรียนเลิกเวลาใด

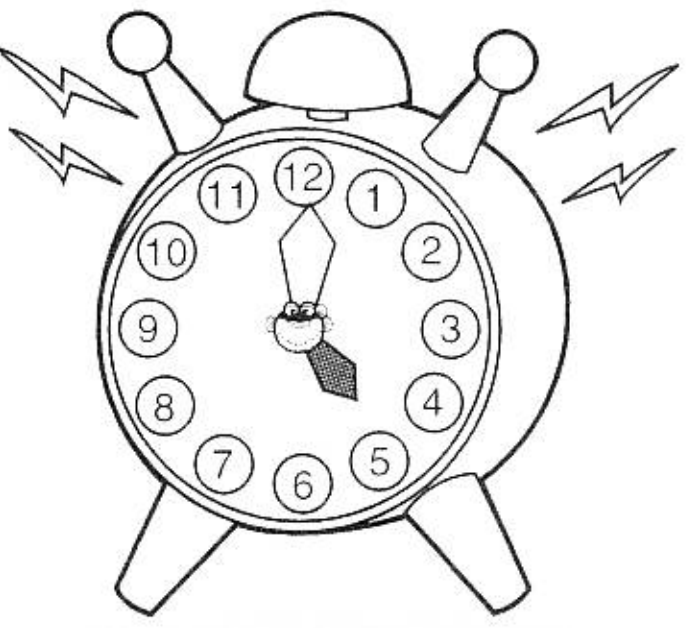
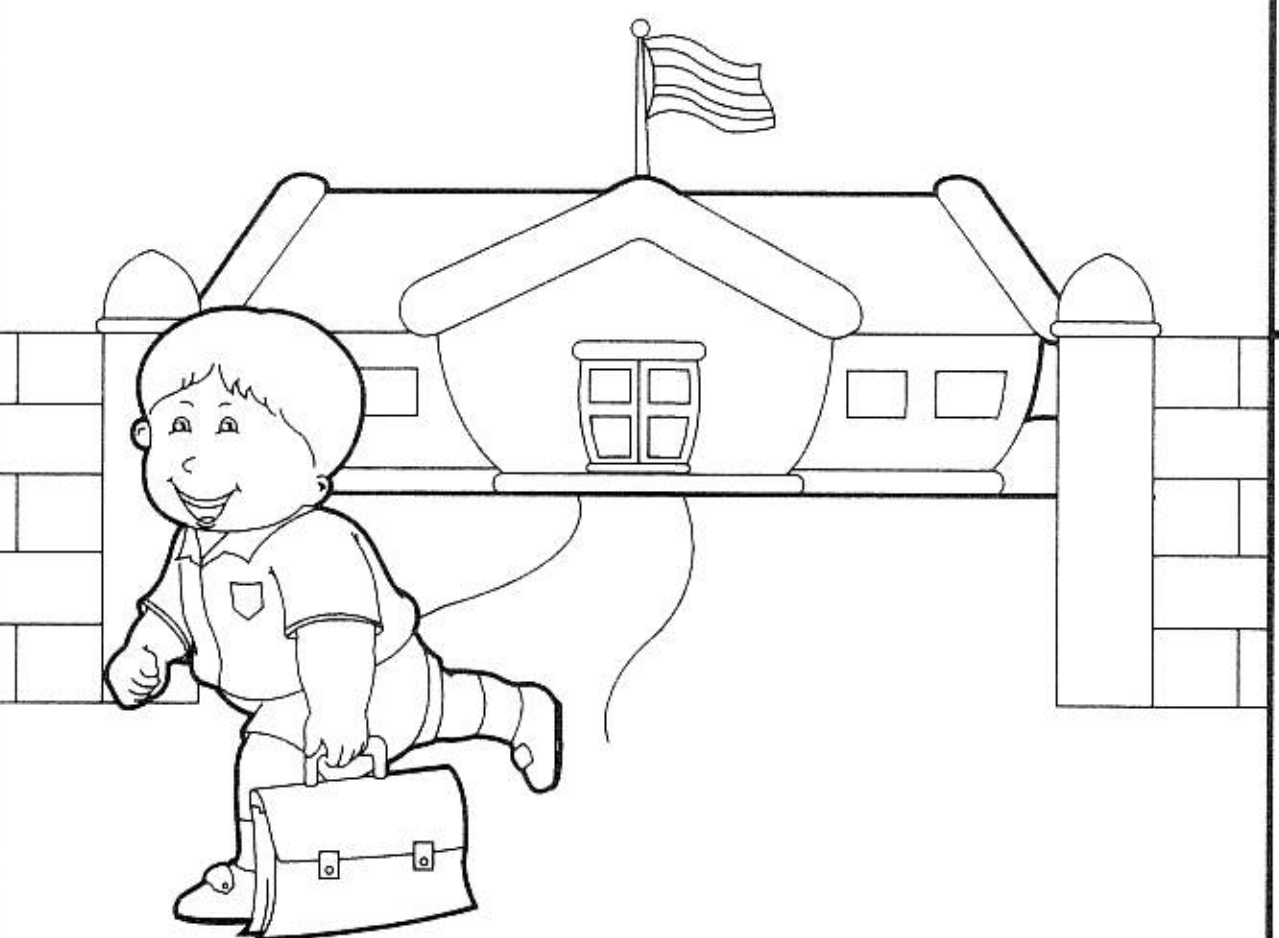

ก

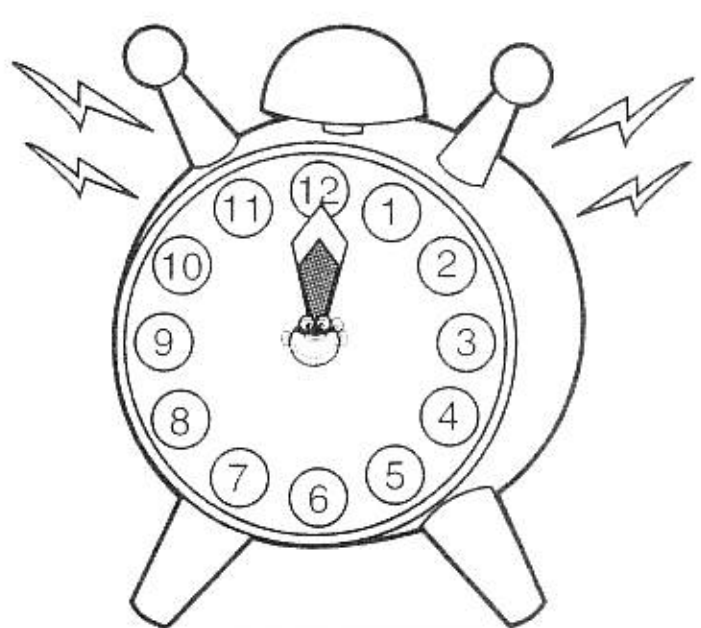

ข

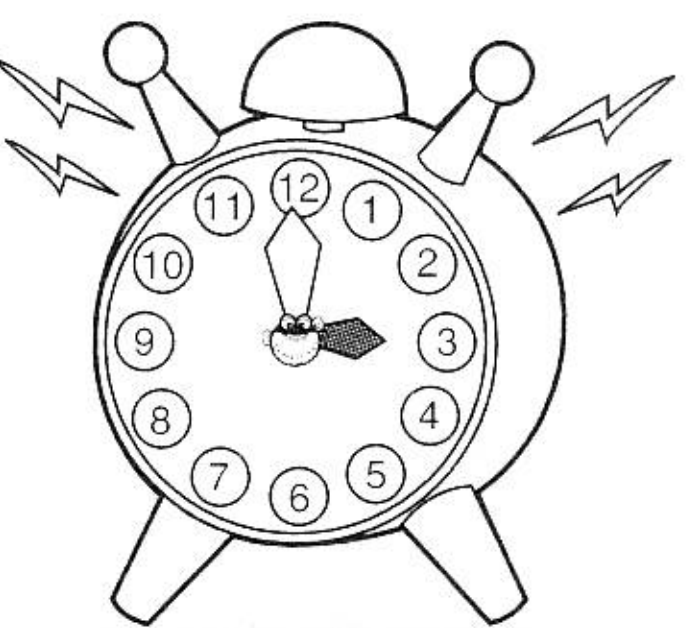

ค

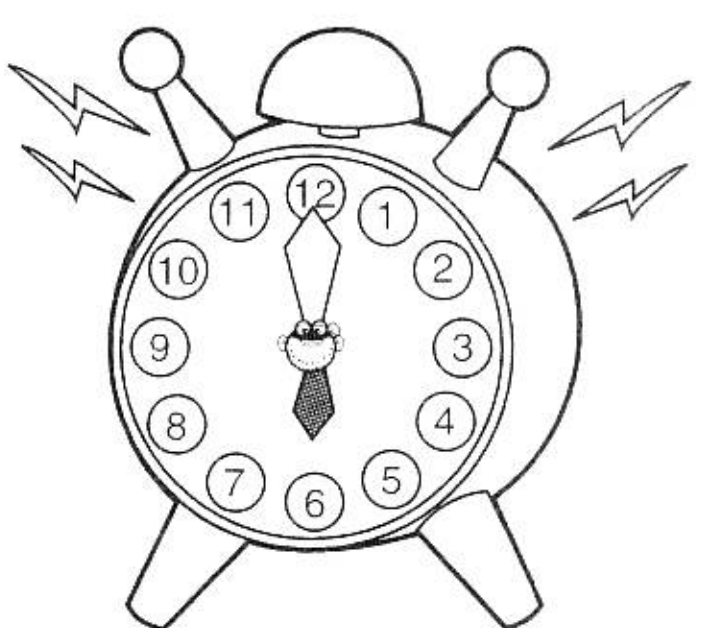

ง



## ตอนที่ 1 ความรู้ทางคณิตศาสตร์

หน้า 4

<b>จงขีด ✓ ข้อที่มีจำนวนพระอาทิตย์เท่ากับไม้บล็อก</b>					หน้า 5-8
1. ง	2. ง	3. ค	4. ค	5. ง	
6. ง	7. ข	8. ค	9. ค	10. ก	
11. ง	12. ข	13. ง	14. ค	15. ง	
16. ข	17. ข	18. ข	19. ค	20. ก	
<b>จงขีด ✓ ข้อที่มีจำนวนเท่ากับภาพในช่องแรก</b>					หน้า 9-10
1. ค	2. ข	3. ง	4. ก	5. ง	
6. ง	7. ข	8. ก	9. ข	10. ง	
<b>จง ○ ข้อที่มีจำนวนมากกว่าภาพในช่องแรก</b>					หน้า 11-12
1. ง	2. ก	3. ค	4. ข	5. ก	
6. ง	7. ค	8. ข	9. ค	10. ข	
<b>จงขีด ✓ ข้อที่มีจำนวนน้อยกว่าภาพในช่องแรก</b>					หน้า 13-14
1. ข	2. ก	3. ค	4. ง	5. ก	
6. ก	7. ข	8. ค	9. ง	10. ง	
<b>จงขีด X ข้อที่มีจำนวนใกล้เคียงกับภาพแรกในช่องแรก</b>					หน้า 15-16
1. ง	2. ก	3. ข	4. ข	5. ค	
6. ข	7. ง	8. ก	9. ง	10. ข	
<b>อ่านคำถามแต่ละข้อให้นักเรียนฟังแล้วให้ ✓ ทับข้อที่ถูกต้อง</b>					หน้า 17-26
1. ค	2. ก	3. ค	4. ง	5. ข	
6. ก	7. ค	8. ข	9. ค	10. ง	
11. ก	12. ข	13. ง	14. ค	15. ก	
16. ข	17. ง	18. ข	19. ก	20. ง	
21. ข	22. ก	23. ค	24. ข	25. ง	
26. ข	27. ก	28. ข	29. ค	30. ค	
<b>จมนับจำนวนกล่องสีขาวยที่สัมผัสกับกล่องสีเทาแล้ว X ข้อที่ถูกต้อง</b>					หน้า 27-31
1. ง	2. ง	3. ข	4. ค	5. ข	
6. ค	7. ง	8. ง	9. ค	10. ก	
11. ข	12. ก	13. ข	14. ข	15. ก	
16. ค	17. ค	18. ข	19. ง	20. ก	

จงขีด ✓ ข้อที่มีสัตว์ตรงกับจำนวนรอยเท้าในช่องแรก

หน้า 32-36

- |       |       |       |       |       |
|-------|-------|-------|-------|-------|
| 1. ข  | 2. ง  | 3. ก  | 4. ข  | 5. ก  |
| 6. ค  | 7. ง  | 8. ง  | 9. ก  | 10. ข |
| 11. ง | 12. ค | 13. ก | 14. ง | 15. ข |

## ตอนที่ 2 การจัดลำดับภาพต่อเนื่อง

หน้า 37

จงขีด ✓ ข้อที่มีภาพต่อเนื่องที่นำมาเติมในช่องว่างได้

หน้า 38-42

- |       |       |       |       |       |
|-------|-------|-------|-------|-------|
| 1. ข  | 2. ค  | 3. ง  | 4. ข  | 5. ก  |
| 6. ง  | 7. ค  | 8. ก  | 9. ข  | 10. ง |
| 11. ค | 12. ก | 13. ง | 14. ข | 15. ก |
| 16. ค | 17. ง | 18. ข | 19. ค | 20. ก |

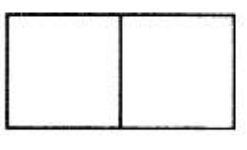
จงเติมจุด ในรูป  ให้ถูกต้อง

หน้า 43-47

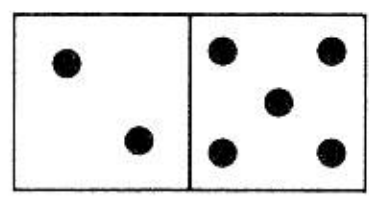
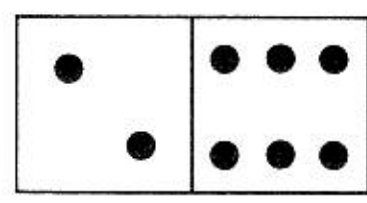
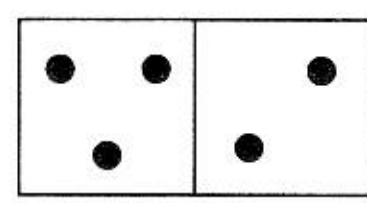
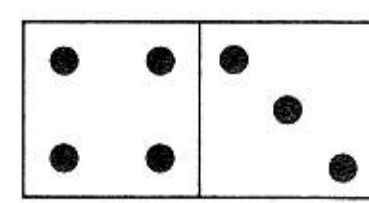
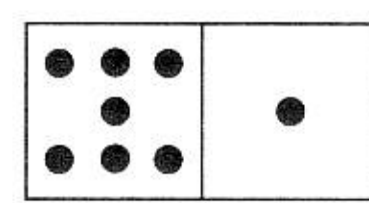
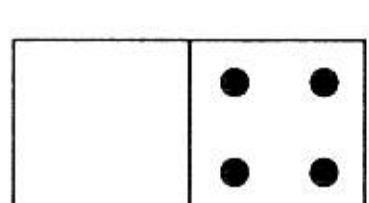
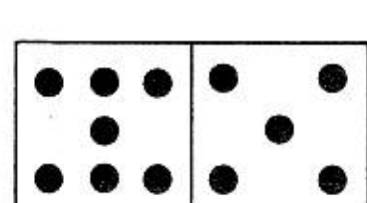
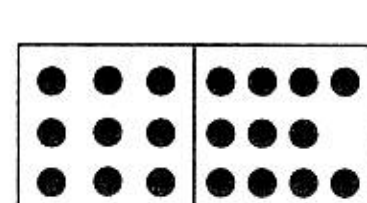
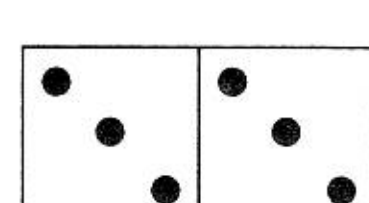
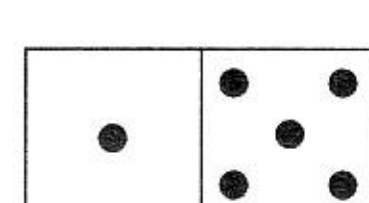
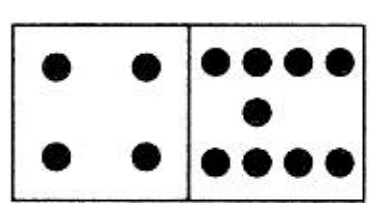
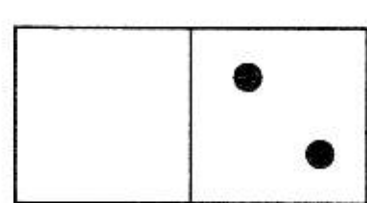
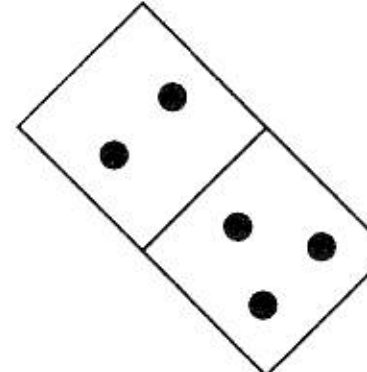
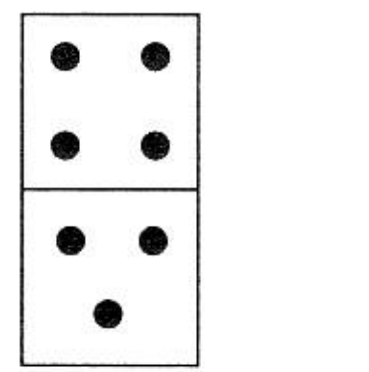
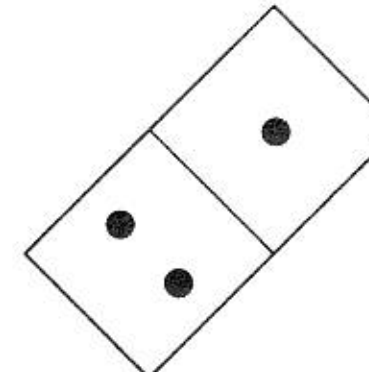
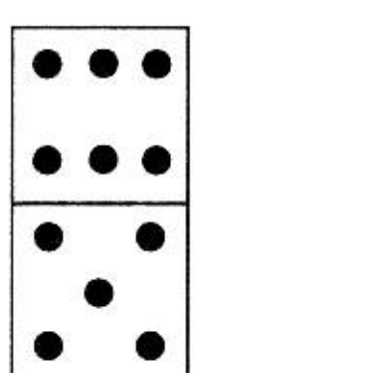
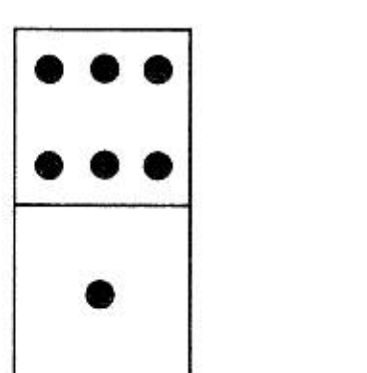
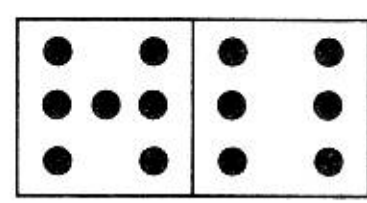
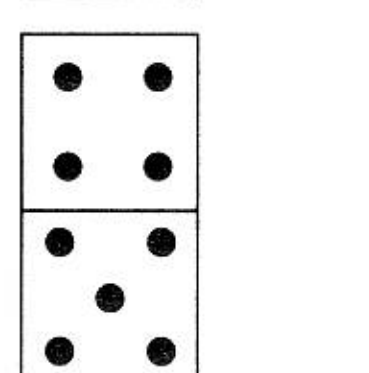
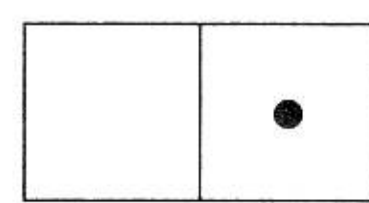
- |   |   |  |   |   |
|---|---|--|---|---|
| 1.   | 2.   | 3.   | 4.   | 5.   |
| 6.   | 7.   | 8.   | 9.   | 10.  |
| 11.  | 12.  | 13.  | 14.  | 15.  |
| 16.  | 17.  | 18.  | 19.  | 20.  |

## ตอนที่ 3 การหาภาพที่สมบูรณ์

หน้า 48

จง X ข้อที่มีชิ้นส่วนที่นำมาเติมภาพที่กำหนดได้พอดี

หน้า 49-58

- |       |       |       |       |       |
|-------|-------|-------|-------|-------|
| 1. ค  | 2. ง  | 3. ค  | 4. ง  | 5. ก  |
| 6. ข  | 7. ก  | 8. ก  | 9. ค  | 10. ข |
| 11. ง | 12. ข | 13. ง | 14. ก | 15. ข |
| 16. ค | 17. ก | 18. ก | 19. ง | 20. ก |

จงขีด ✓ ข้อที่เป็นรูปเต็มของภาพแรกเมื่อกางกระดาษออก

หน้า 59-62

- |       |       |       |       |       |
|-------|-------|-------|-------|-------|
| 1. ค  | 2. ง  | 3. ก  | 4. ค  | 5. ข  |
| 6. ก  | 7. ค  | 8. ข  | 9. ก  | 10. ง |
| 11. ก | 12. ค | 13. ข | 14. ก | 15. ง |
| 16. ข | 17. ก | 18. ง | 19. ก | 20. ก |

จงขีด ✓ ข้อที่พับแล้วได้กล่องเหมือนภาพในช่องแรก

หน้า 63-67

- |       |       |       |       |       |
|-------|-------|-------|-------|-------|
| 1. ก  | 2. ข  | 3. ค  | 4. ง  | 5. ข  |
| 6. ค  | 7. ก  | 8. ง  | 9. ค  | 10. ก |
| 11. ค | 12. ง | 13. ข | 14. ก | 15. ง |

#### ตอนที่ 4 การเปรียบเทียบ ปริมาณ น้ำหนัก ระยะทาง พื้นที่ว่าง

หน้า 68

จงหาความสัมพันธ์ของปริมาณน้ำที่กำหนดในภาพแรกโดย ✓ หน้าข้อ

หน้า 69-73

- |       |       |       |       |       |
|-------|-------|-------|-------|-------|
| 1. ก  | 2. ข  | 3. ก  | 4. ข  | 5. ค  |
| 6. ค  | 7. ง  | 8. ข  | 9. ก  | 10. ข |
| 11. ง | 12. ค | 13. ข | 14. ข | 15. ง |

จงขีด ✓ ข้อที่มีน้ำหนักสัมพันธ์กับภาพในช่องแรก

หน้า 74-78

- |       |       |       |       |       |
|-------|-------|-------|-------|-------|
| 1. ง  | 2. ก  | 3. ข  | 4. ค  | 5. ก  |
| 6. ข  | 7. ง  | 8. ค  | 9. ก  | 10. ง |
| 11. ก | 12. ค | 13. ข | 14. ค | 15. ง |

จงขีด ✓ ข้อที่มีระยะทางยาวเท่ากับภาพในช่องแรก

หน้า 79-83

- |       |       |       |       |       |
|-------|-------|-------|-------|-------|
| 1. ค  | 2. ข  | 3. ก  | 4. ง  | 5. ข  |
| 6. ก  | 7. ค  | 8. ค  | 9. ค  | 10. ก |
| 11. ก | 12. ค | 13. ก | 14. ค | 15. ข |

จงขีด ✓ ข้อที่มีพื้นที่ว่างเท่ากับภาพแรก

หน้า 84-88

- |       |       |       |       |       |
|-------|-------|-------|-------|-------|
| 1. ก  | 2. ง  | 3. ค  | 4. ง  | 5. ก  |
| 6. ข  | 7. ค  | 8. ง  | 9. ก  | 10. ข |
| 11. ก | 12. ง | 13. ข | 14. ก | 15. ค |

#### ตอนที่ 5 ความรู้เรื่องเวลา และนาฬิกา

หน้า 89

จงขีด ✓ ข้อที่นาฬิกาบอกเวลาตามภาพที่กำหนดในช่องแรก

หน้า 90-93

- |       |       |      |      |       |
|-------|-------|------|------|-------|
| 1. ก  | 2. ค  | 3. ก | 4. ข | 5. ก  |
| 6. ก  | 7. ค  | 8. ง | 9. ก | 10. ก |
| 11. ข | 12. ค |      |      |       |

