

เล่ม 1

ตัวลูกเตรียมสอบ

คู่มือเตรียมสอบเข้า ป.1 โรงเรียนในเครือสาธิต
ใช้เป็นแนวข้อสอบเข้าโรงเรียนในเครือคาทอลิก

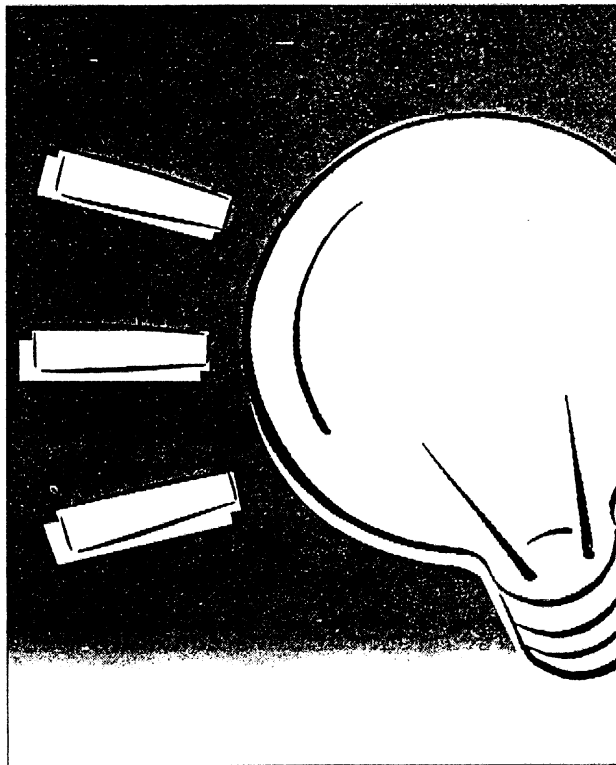

จัดทำโดย
สำนักพิมพ์ พาสพับลิชชิ่ง

PASS
PUBLISHING

ชื่อ..... นามสกุล

สารบัญ

	หน้า
ตอนที่ 1 ความรู้ทางคณิตศาสตร์	4
จงขีด ✓ ข้อที่มีจำนวนพระอาทิตย์เท่ากับไม้บล็อก	5-8
จงขีด ✓ ข้อที่มีจำนวนเท่ากับภาพในช่องแรก	9-10
จง ○ ข้อที่มีจำนวนมากกว่าภาพในช่องแรก	11-12
จงขีด ✓ ข้อที่มีจำนวนน้อยกว่าภาพในช่องแรก	13-14
จง X ข้อที่มีจำนวนใกล้เคียงกับภาพในช่องแรก	15-16
อ่านคำถามแต่ละข้อให้นักเรียนฟังแล้วให้ ✓ ทับข้อที่ถูกต้อง	17-26
จงนับจำนวนกล่องสีขาวที่สัมผัสกับกล่องสีเทาแล้ว X ข้อที่ถูกต้อง	27-31
จงขีด ✓ ข้อที่มีสัตว์ตรงกับจำนวนรอยเท้าในช่องแรก	32-36
ตอนที่ 2 การจัดลำดับภาพต่อเนื่อง	37
จงขีด ✓ ข้อที่มีภาพต่อเนื่องที่นำมาเติมในช่องว่างได้	38-42
จงเติมจุดใน <input type="checkbox"/> <input type="checkbox"/> ให้ถูกต้อง	43-47
ตอนที่ 3 การหาภาพที่สมบูรณ์	48
จง X ข้อที่มีชิ้นส่วนที่นำมาเติมภาพที่กำหนดได้พอดี	49-58
จงขีด ✓ ข้อที่เป็นรูปเต็มของภาพแรกเมื่อกางกระดาษออก	59-62
จงขีด ✓ ข้อที่พับแล้วได้กล่องเหมือนภาพในช่องแรก	63-67
ตอนที่ 4 การเปรียบเทียบ ปริมาณ น้ำหนัก ระยะทาง พื้นที่ว่าง	68
จงหาความสัมพันธ์ของปริมาณน้ำที่กำหนด ในภาพแรกโดย ✓ หน้าข้อ	69-73
จงขีด ✓ ข้อที่น้ำหนักสัมพันธ์กับภาพในช่องแรก	74-78
จงขีด ✓ ข้อที่มีระยะทางยาวเท่ากับภาพในช่องแรก	79-83
จงขีด ✓ ข้อที่มีพื้นที่ว่าง เท่ากับภาพแรก	84-88
ตอนที่ 5 ความรู้เรื่องเวลาและนาฬิกา	89
จงขีด ✓ ข้อที่นาฬิกาบอกเวลาตามภาพที่กำหนด ในช่องแรก	90-93
เฉลย	94-96



6

	<p>ဂ</p>	<p>ဈ</p>	<p>င</p>	<p>ဆ</p>
--	----------	----------	----------	----------

7

	<p>ဂ</p>	<p>ဈ</p>	<p>င</p>	<p>ဆ</p>
--	----------	----------	----------	----------

8

	<p>ဂ</p>	<p>ဈ</p>	<p>င</p>	<p>ဆ</p>
--	----------	----------	----------	----------

9

	<p>ဂ</p>	<p>ဈ</p>	<p>င</p>	<p>ဆ</p>
--	----------	----------	----------	----------

10

	<p>ဂ</p>	<p>ဈ</p>	<p>င</p>	<p>ဆ</p>
--	----------	----------	----------	----------

จงขีด ✓ ข้อที่มีจำนวนพระอาทิตย์เท่ากับไม้บล็อก

1

	 ก	 ข	 ค	 ง
--	-------	-------	-------	-------

2

	 ก	 ข	 ค	 ง
--	-------	-------	-------	-------

3

	 ก	 ข	 ค	 ง
--	-------	-------	-------	-------

4

	 ก	 ข	 ค	 ง
--	-------	-------	-------	-------



5

	 ก	 ข	 ค	 ง
--	-------	-------	-------	-------

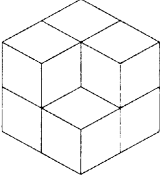
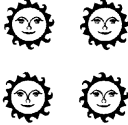
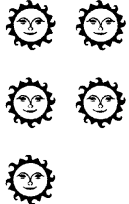
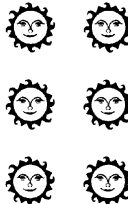
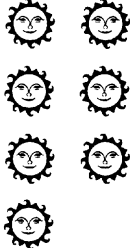

11

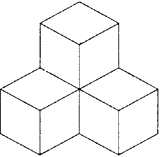
	 ဂ	 ဈ	 ခ	 ၃
---	--	--	---	--

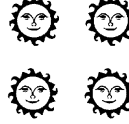
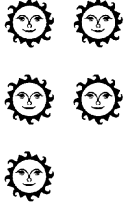
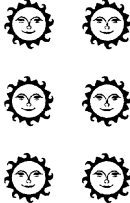
12

	 ဂ	 ဈ	 ခ	 ၃
---	--	--	---	--

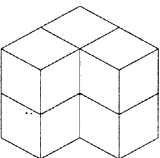
13

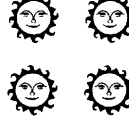
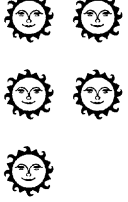
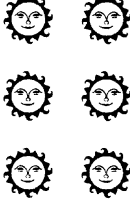
	 ဂ	 ဈ	 ခ	 ၃
---	--	--	---	--

14

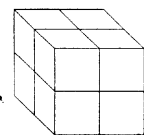
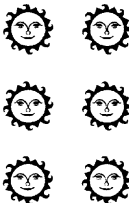
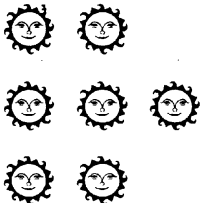
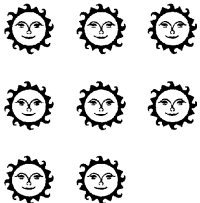
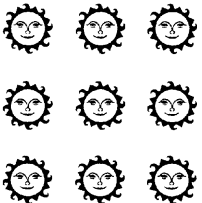
	 ဂ	 ဈ	 ခ	 ၃
---	--	--	---	--

15

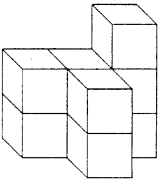
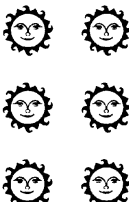
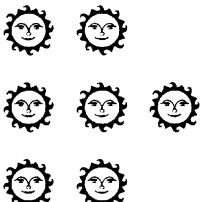
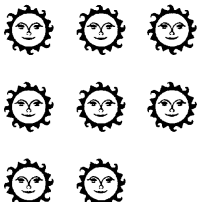
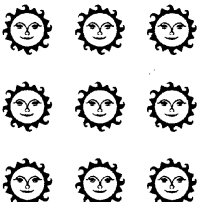
	 ဂ	 ဈ	 ခ	 ၃
---	--	--	---	--

16

	<p>ဂ</p>	<p>ဈ</p>	<p>ဃ</p>	<p>၇</p>
--	----------	----------	----------	----------

17

	<p>ဂ</p>	<p>ဈ</p>	<p>ဃ</p>	<p>၇</p>
--	----------	----------	----------	----------

18

	<p>ဂ</p>	<p>ဈ</p>	<p>ဃ</p>	<p>၇</p>
--	----------	----------	----------	----------

19

	<p>ဂ</p>	<p>ဈ</p>	<p>ဃ</p>	<p>၇</p>
--	----------	----------	----------	----------

20

	<p>ဂ</p>	<p>ဈ</p>	<p>ဃ</p>	<p>၇</p>
--	----------	----------	----------	----------

จงขีด ✓ ข้อที่มีจำนวนเท่ากับภาพในช่องแรก

1

	ก	ข	ค	ง

2

	ก	ข	ค	ง

3

	ก	ข	ค	ง

4

	ก	ข	ค	ง

5

	ก	ข	ค	ง

6

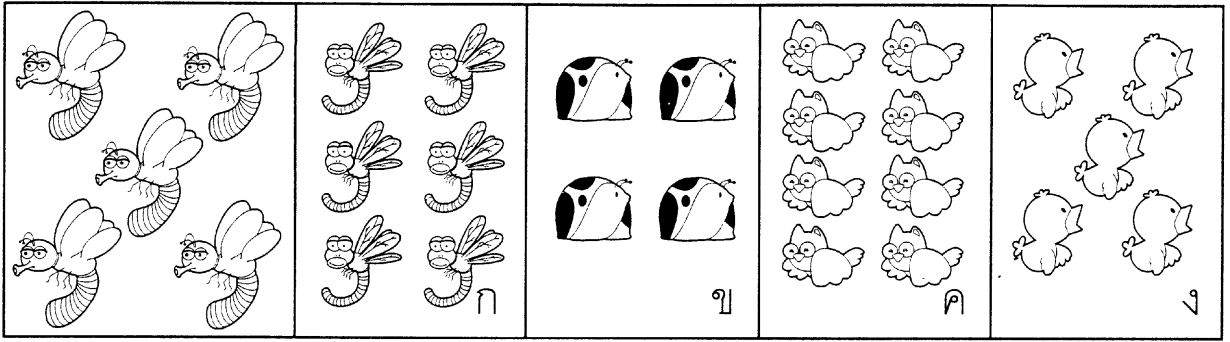

7

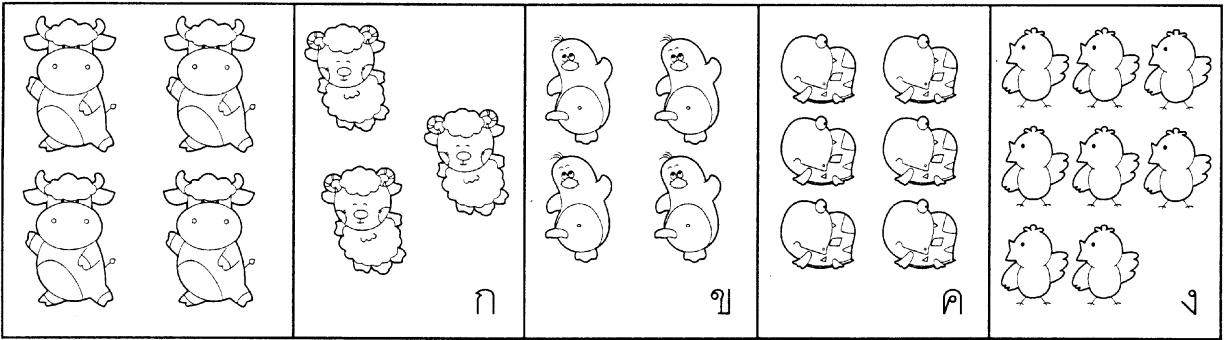

8

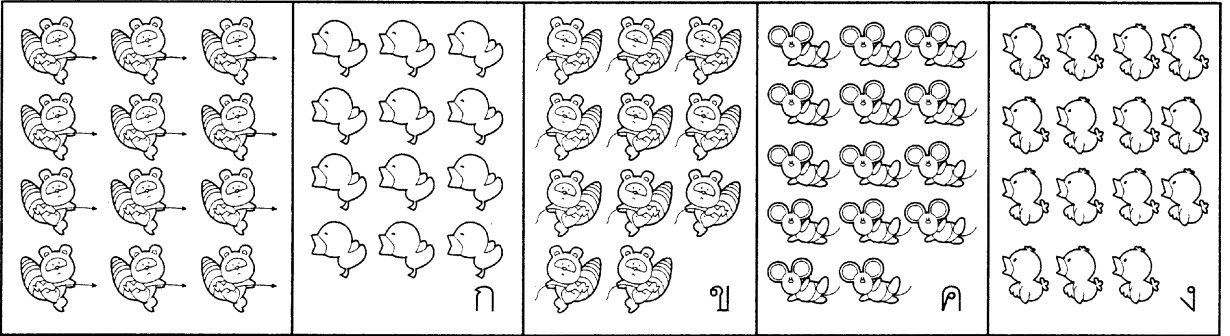

9

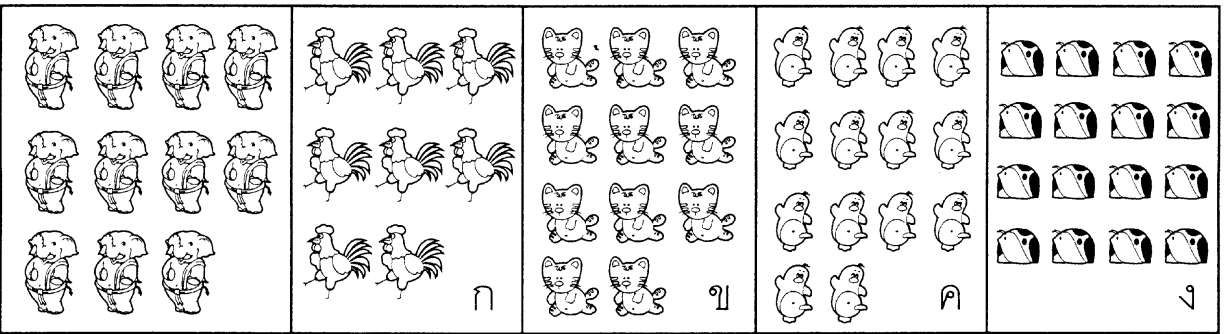

10

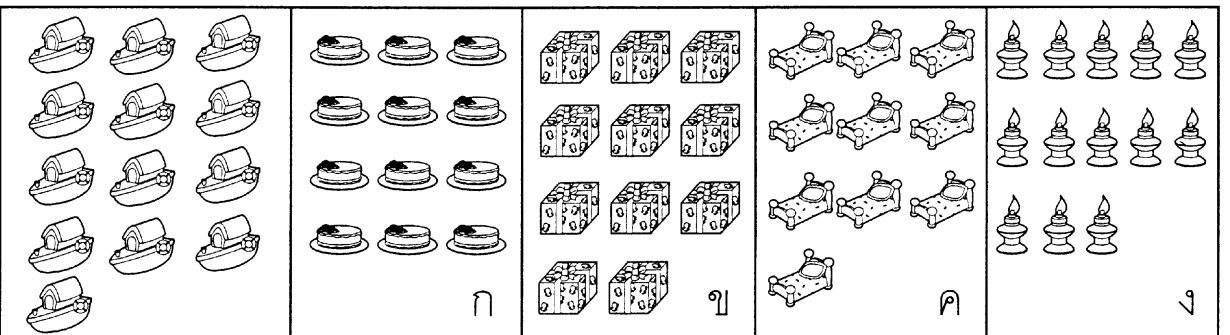

จง ○ ข้อที่มีจำนวนมากกว่าภาพในช่องแรก

1

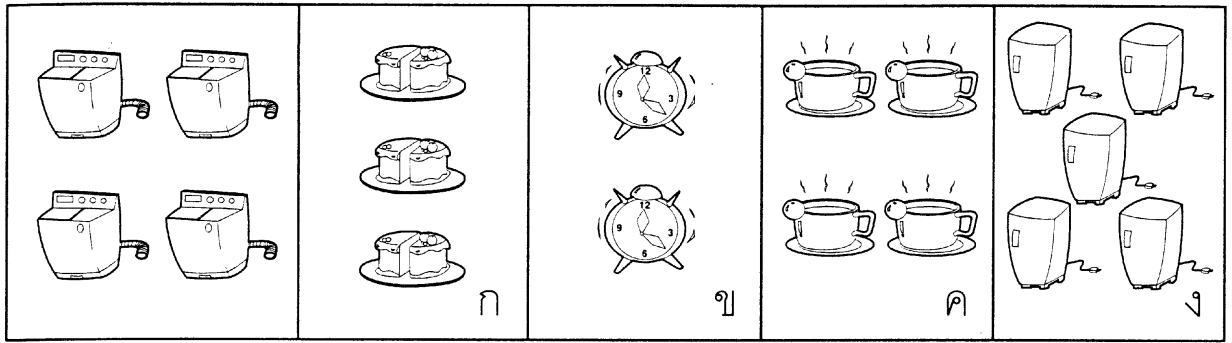

2

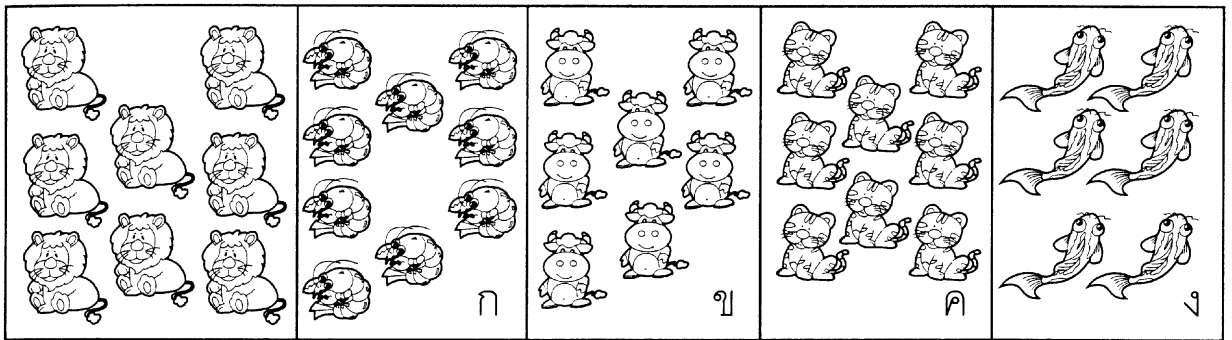

3

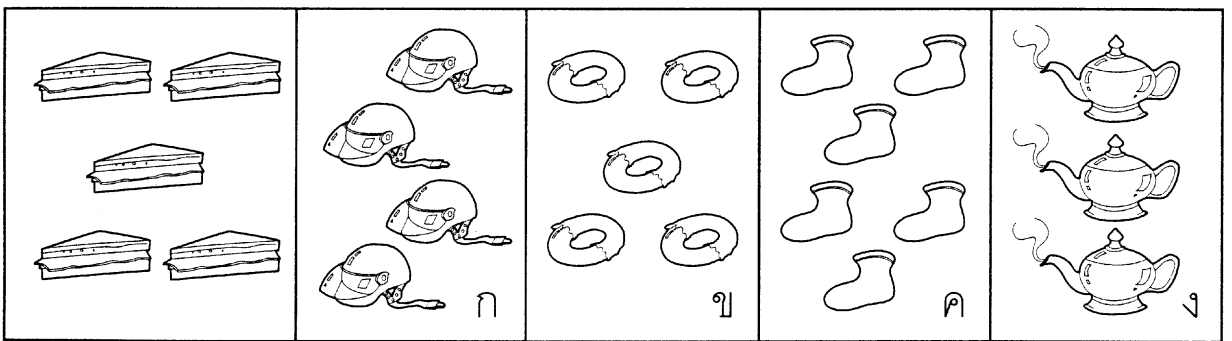

4

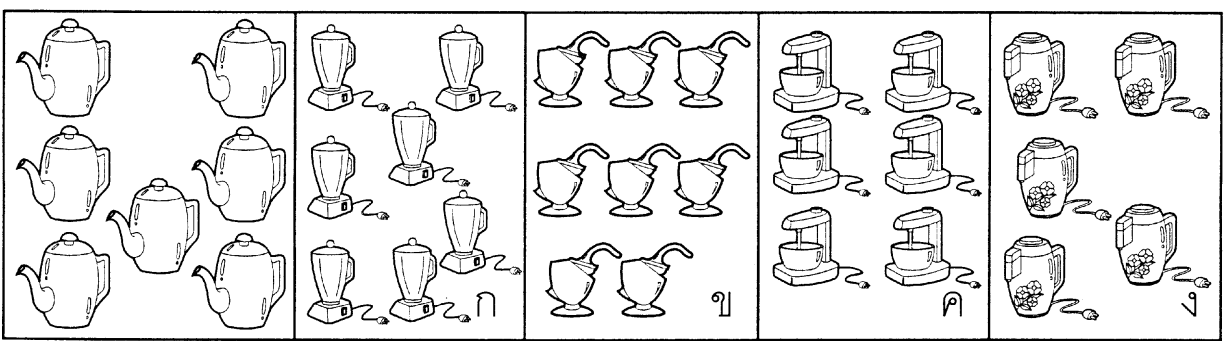

5

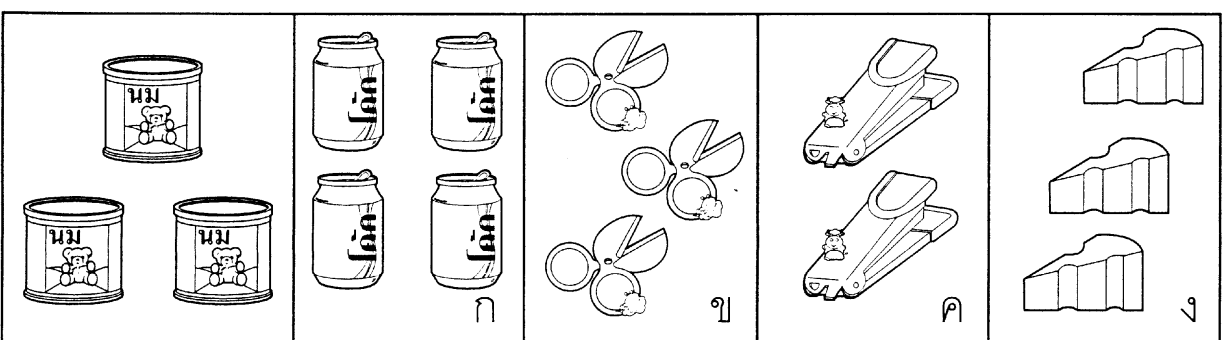

6

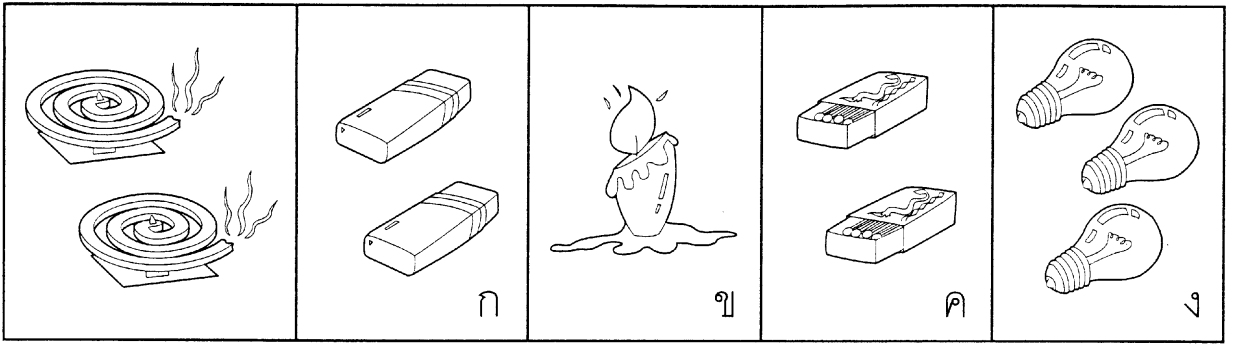

7

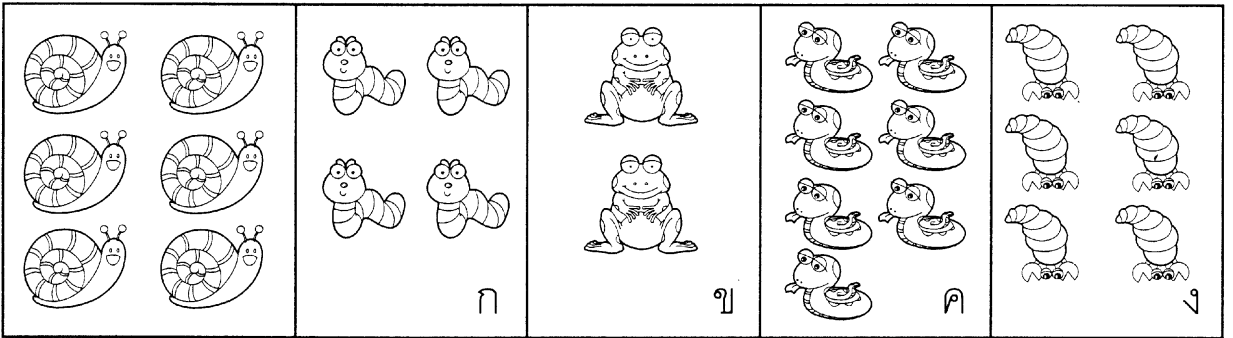

8

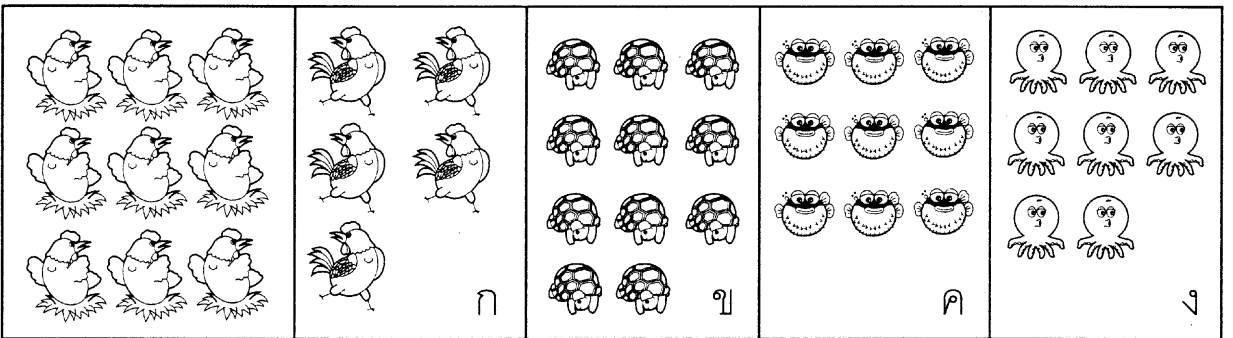

9

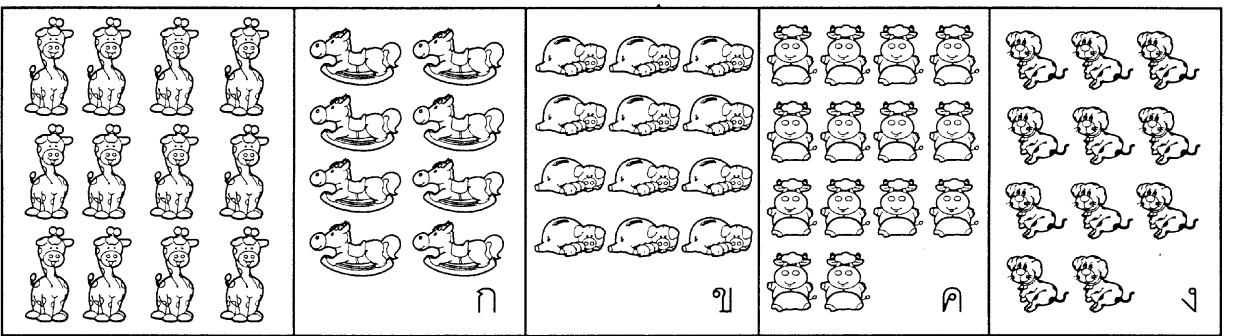

10

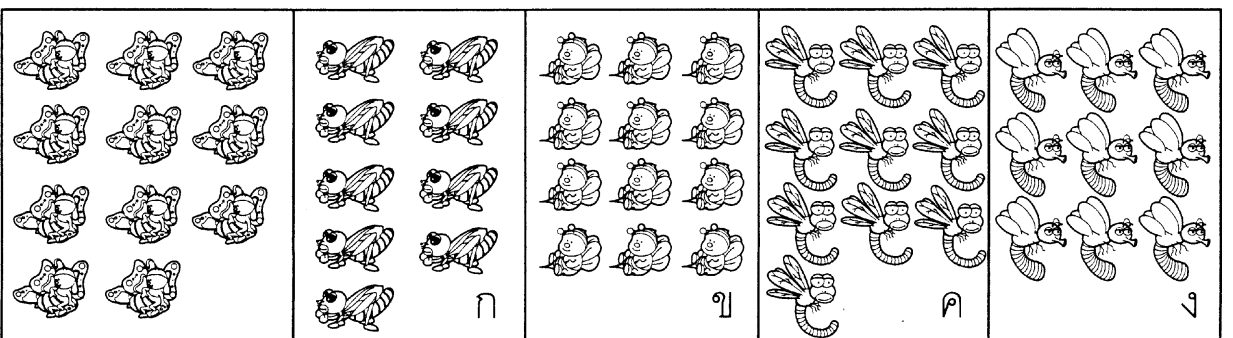

จงขีด ✓ ข้อที่มีจำนวนน้อยกว่าภาพในช่องแรก

1

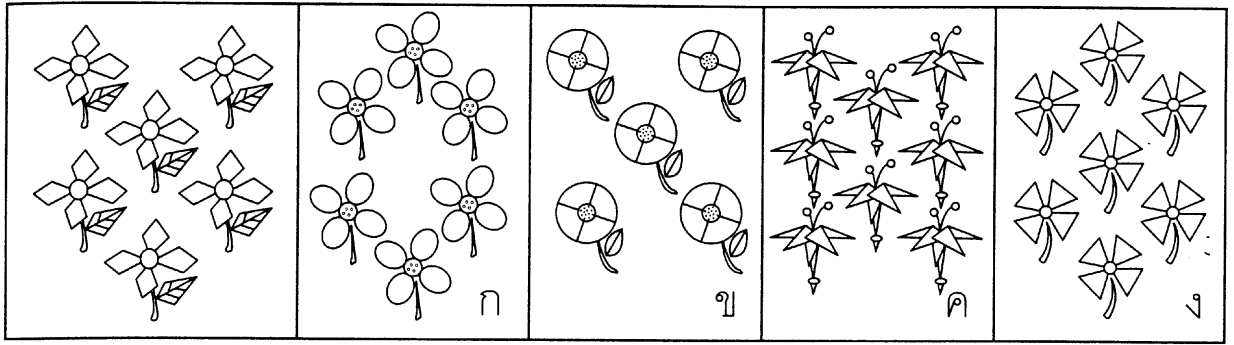

2

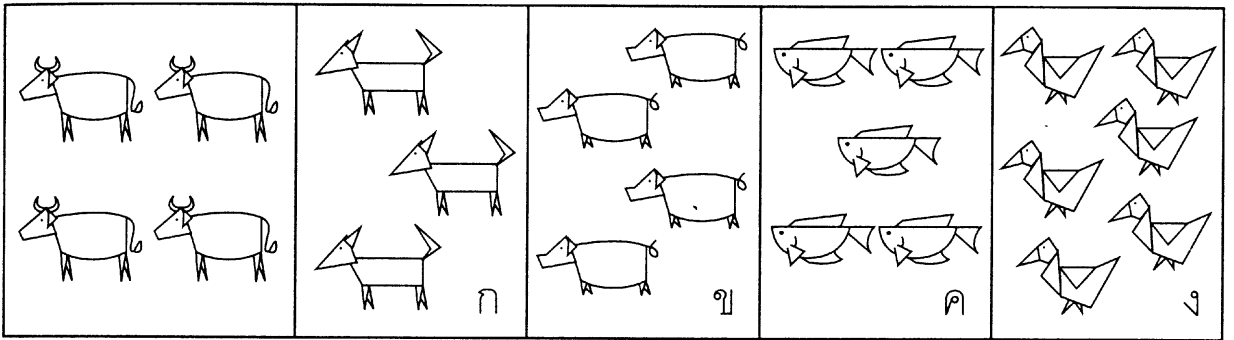

3

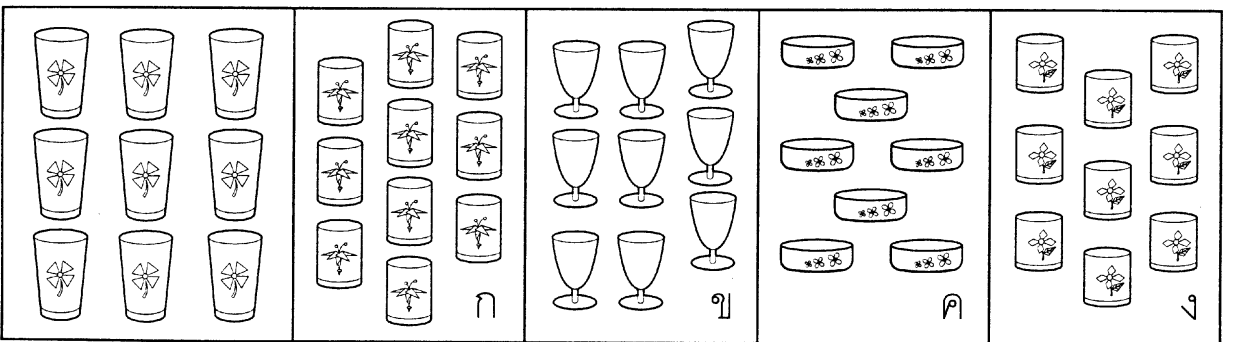

4

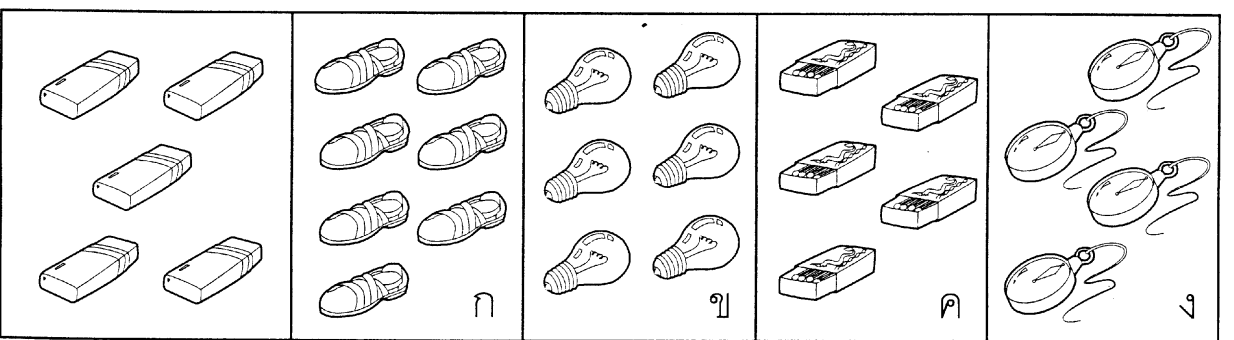

5

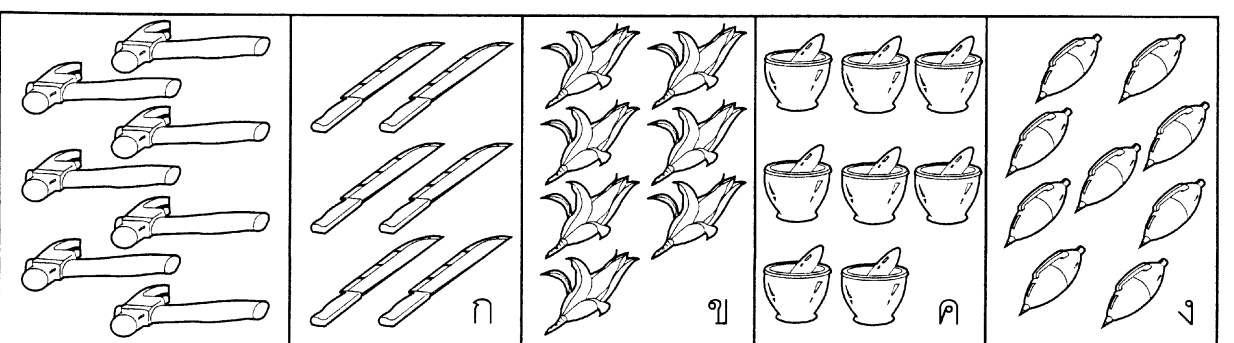

6

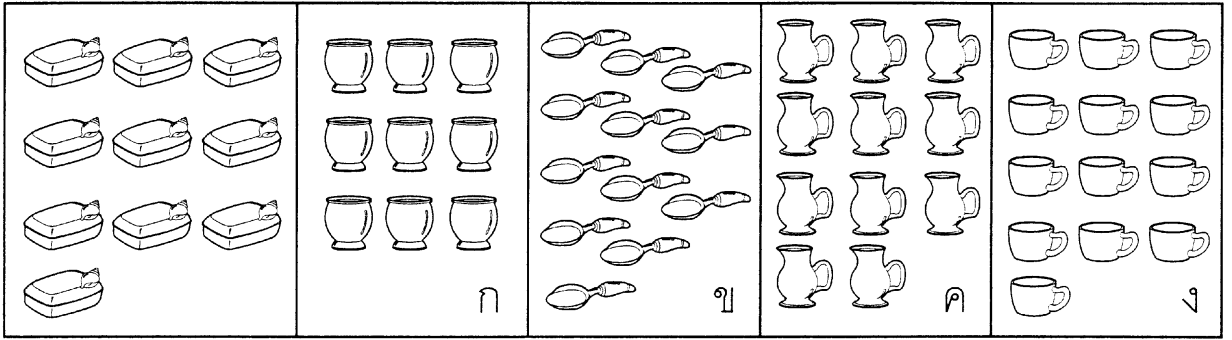

7

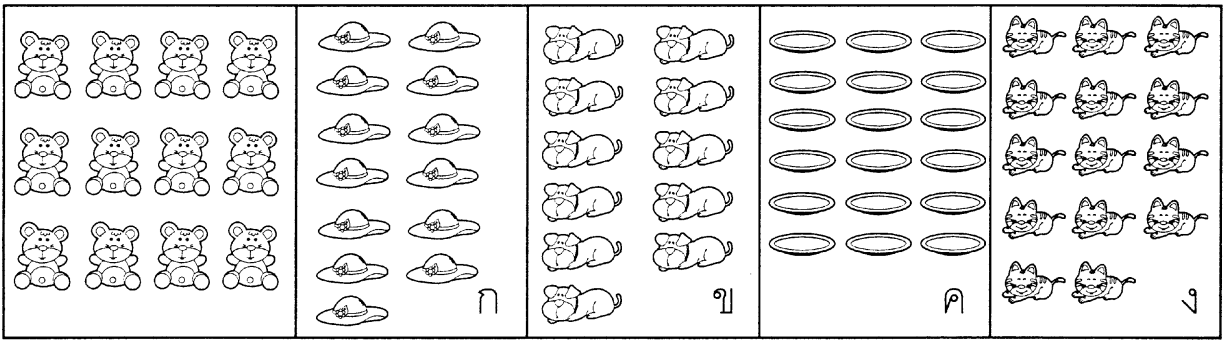

8

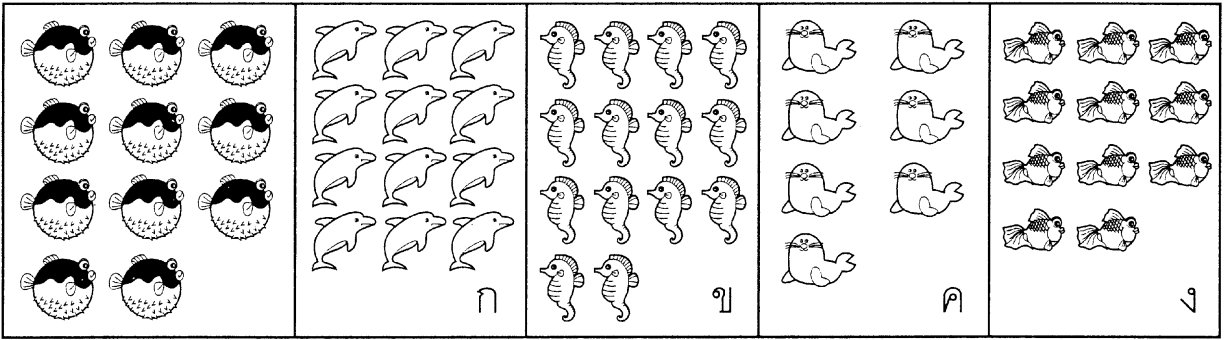

9

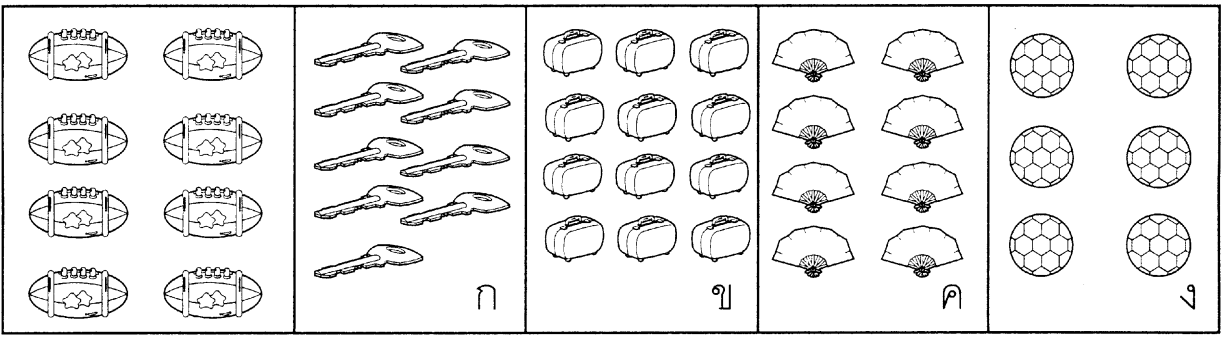

10

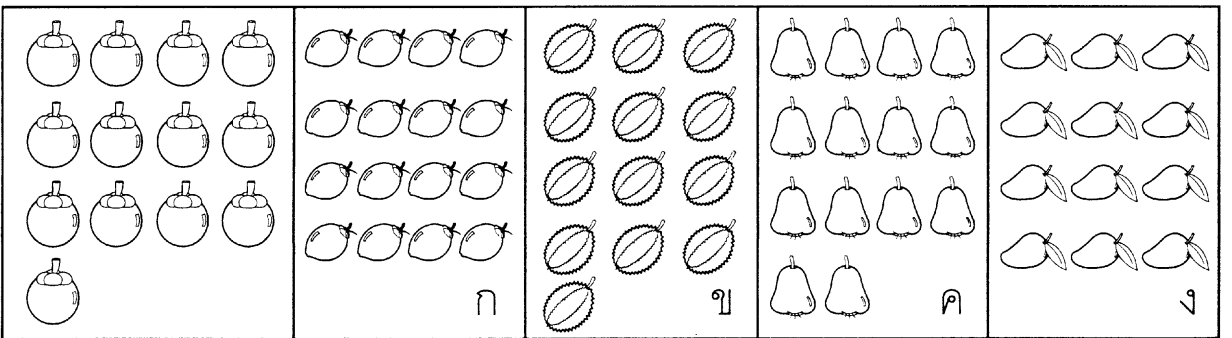

จงขีด ✕ ข้อที่มีจำนวนใกล้เคียงกับภาพในช่องแรก

1

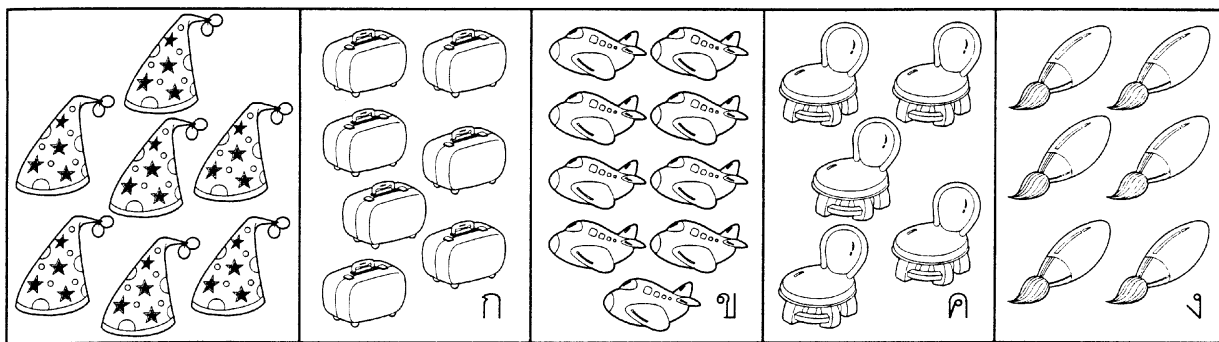

2

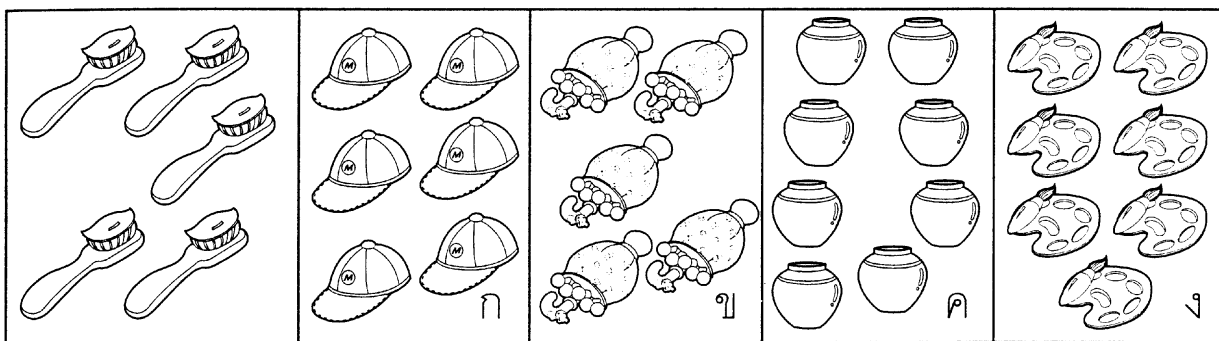

3

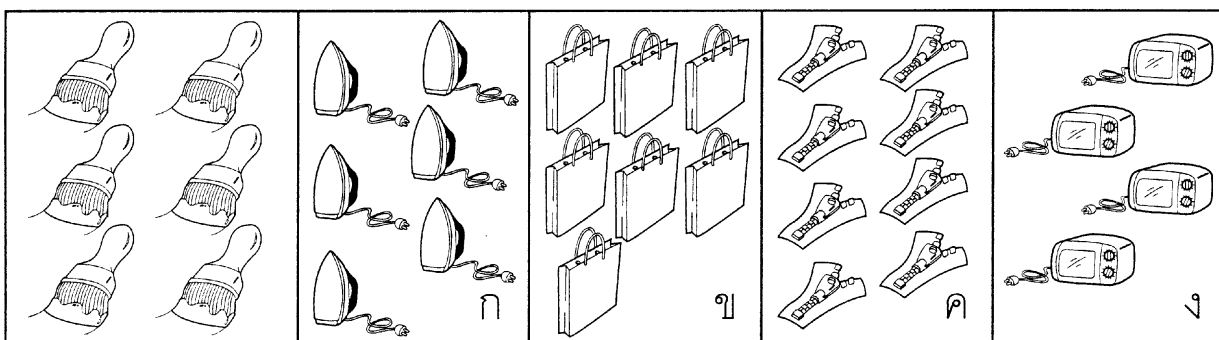

4

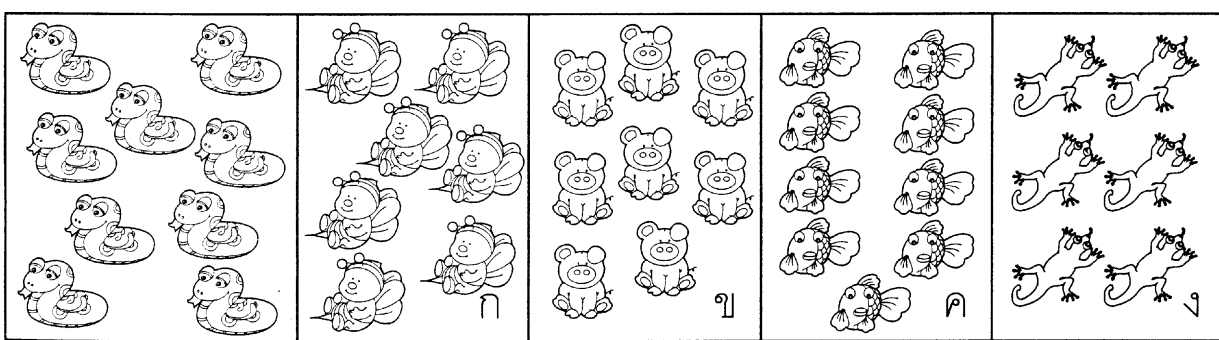

5

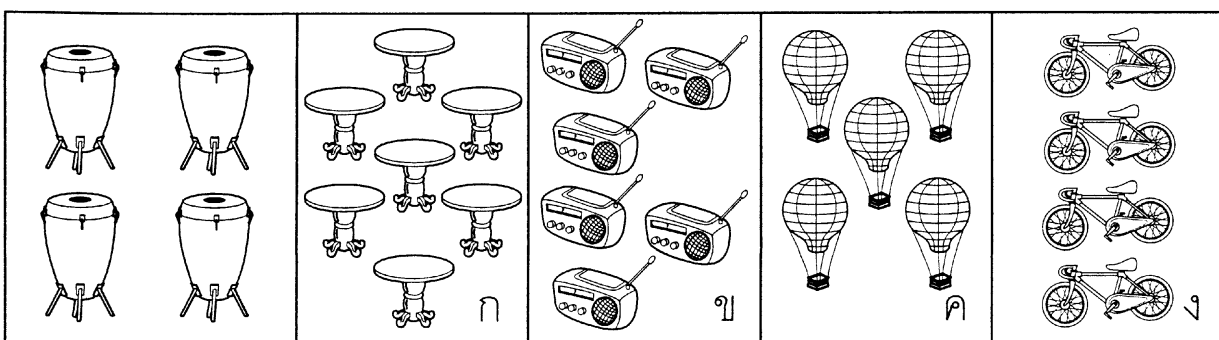

6

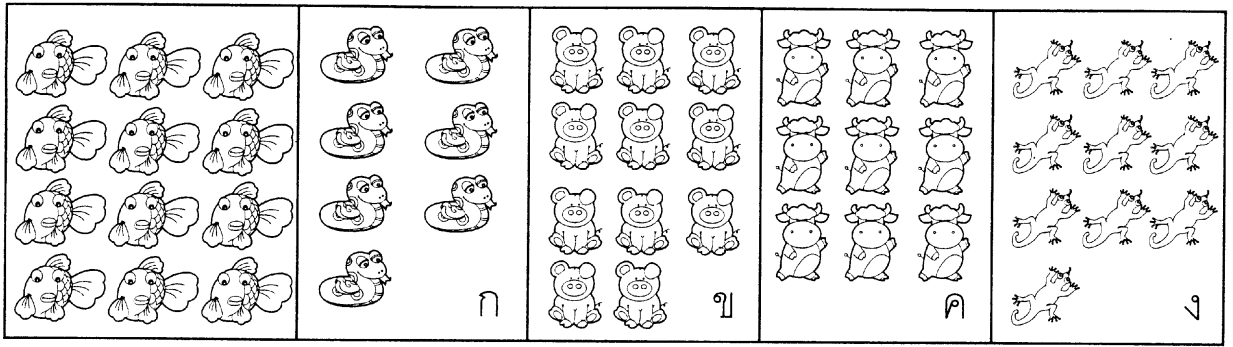

7

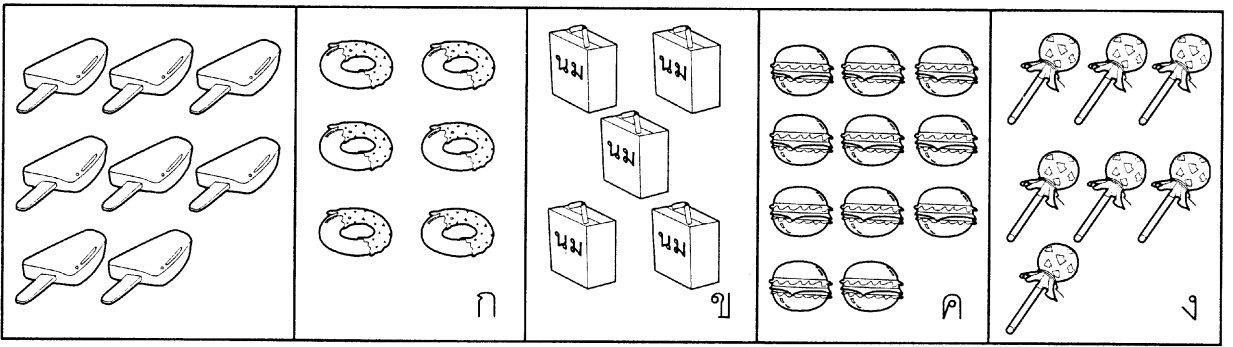

8

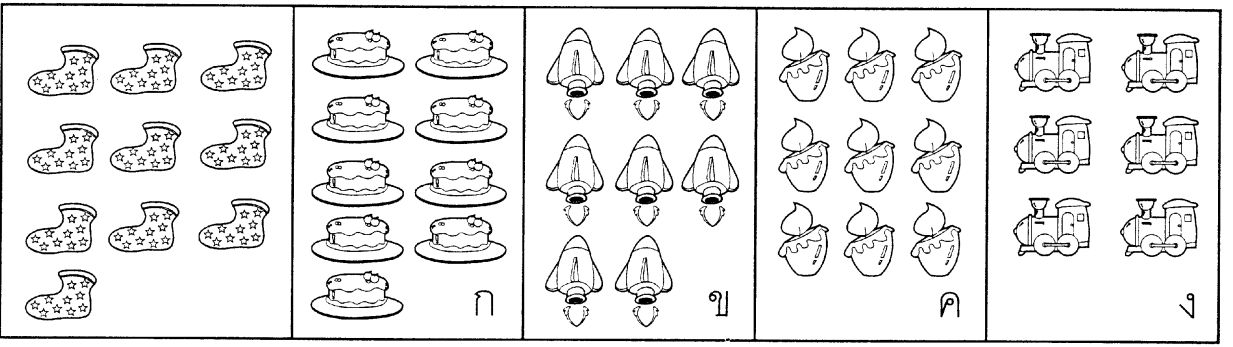

9

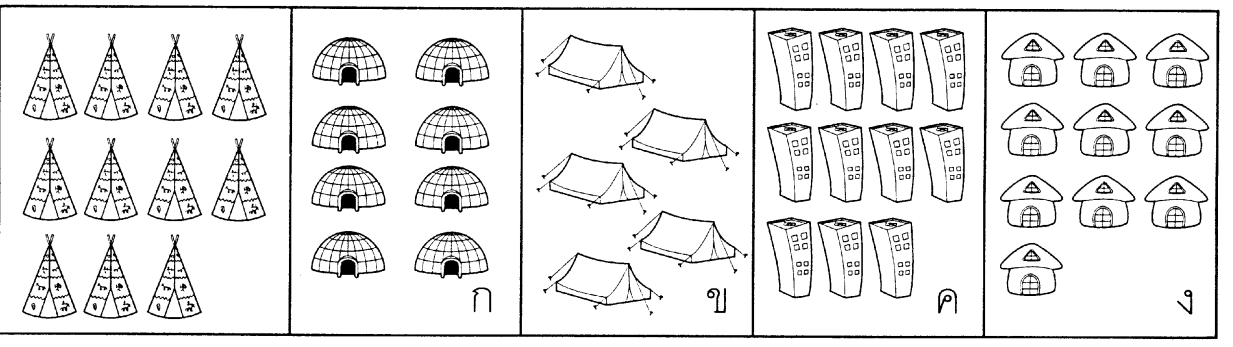

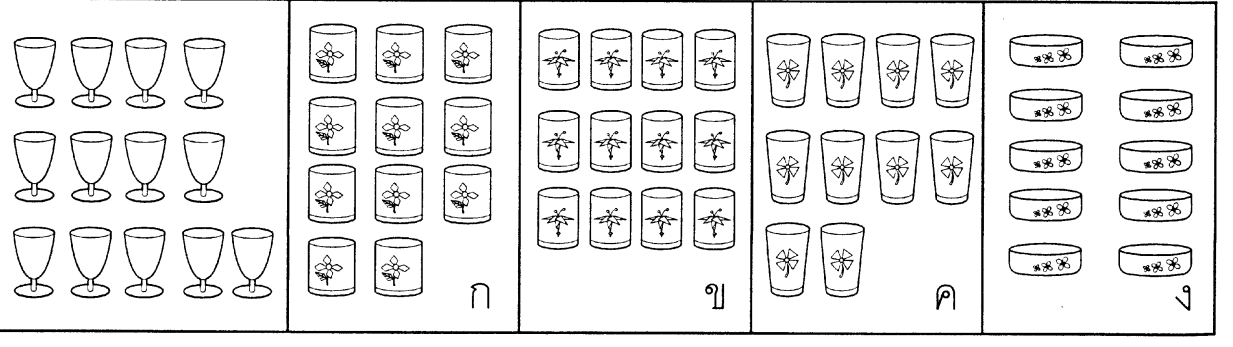

10

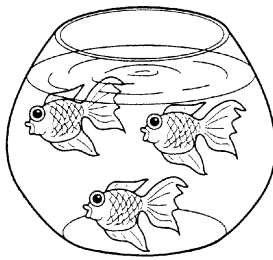

อ่านคำถามแต่ละข้อให้นักเรียนฟังแล้วให้ ✓ ทับข้อที่ถูกต้อง

1 มีปลาอยู่ในอ่าง 3 ตัว
ออกลูกมาอีก 4 ตัว
มีปลาอยู่ในอ่างกี่ตัว

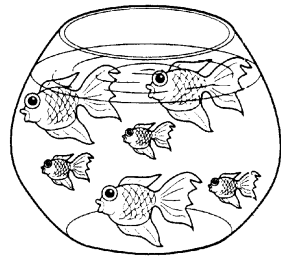
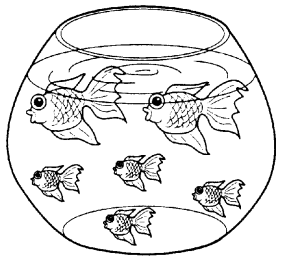
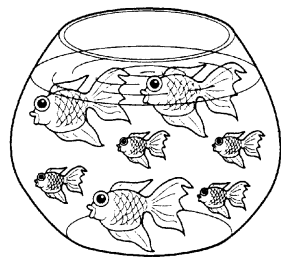

 ก	 ข
 ค	 ง

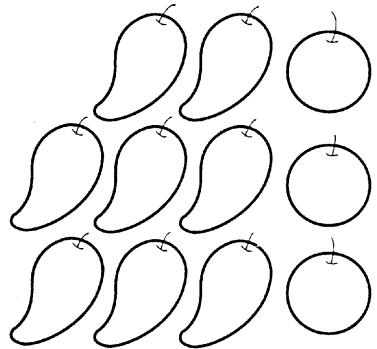

2 มีมะม่วงอยู่ 8 ผล
มีส้มอยู่ 3 ผล ต้องหาส้ม
มาเพิ่มอีกกี่ผลจึง
จะเท่ากับมะม่วง

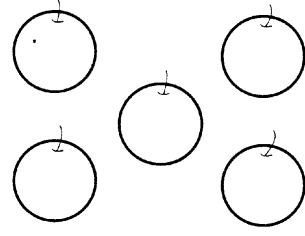
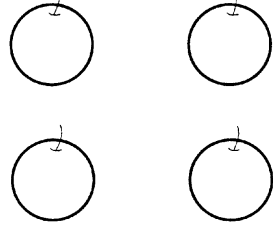
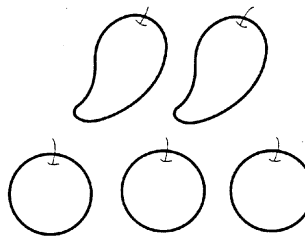
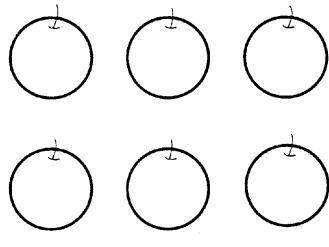

 ก	 ข
 ค	 ง

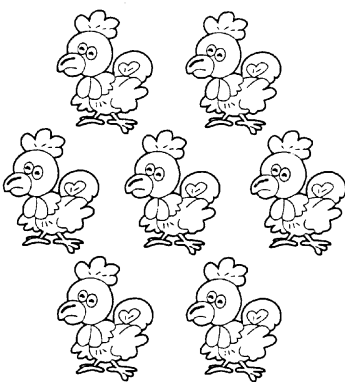

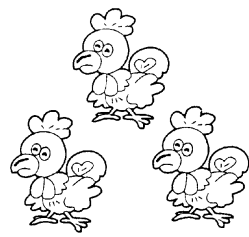
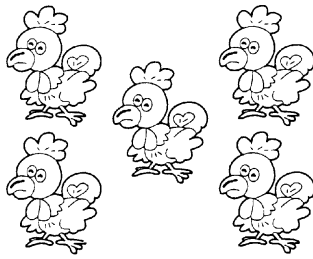
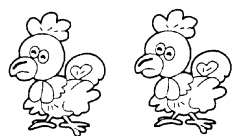





3 ลูกเลี้ยงไก่ 7 ตัว
ขายไป 5 ตัว ลูกมีไก่กี่ตัว



 ก	 ข
 ค	 ง

4 น้องมีขนม 3 ชิ้น
แม่ให้มาอีก 2 ชิ้น
น้องมีขนมกี่ชิ้น



  <p>ก</p>	  <p>ข</p>
 <p>ค</p>	   <p>ง</p>

5 เปิดออกไข่มา 8 ฟอง
ฟักเป็นตัว 4 ฟอง
ยังไม่ฟักอีกกี่ฟอง

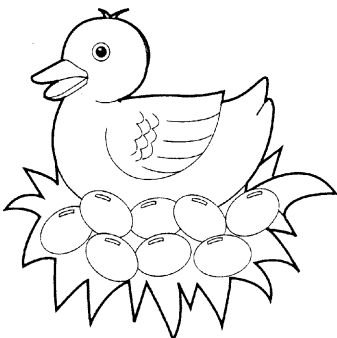

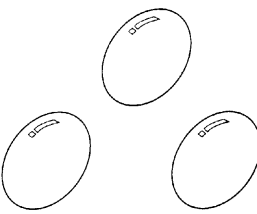
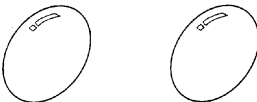
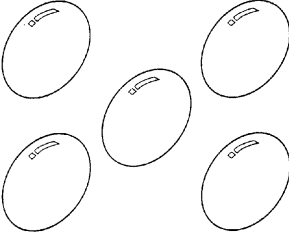
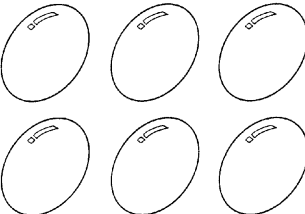
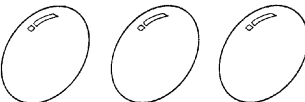
 <p>ก</p>	  <p>ข</p>
 <p>ค</p>	  <p>ง</p>

6 มีดอกไม้ 10 ดอก
จัดใส่แจกัน 6 ดอก
จะเหลือกี่ดอก

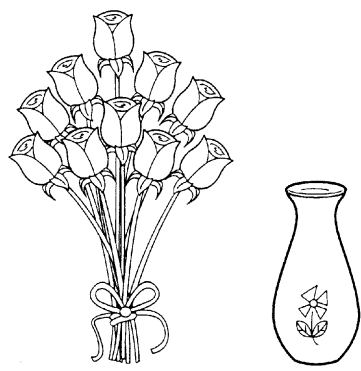

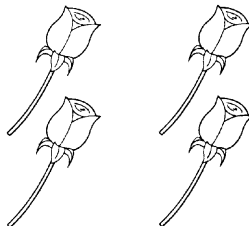
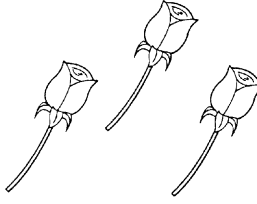
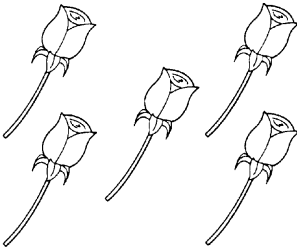
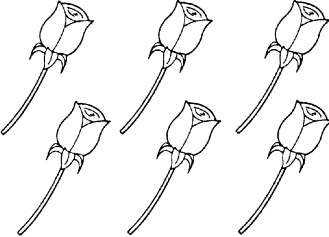
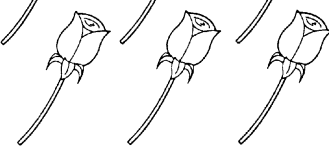
 <p>ก</p>	 <p>ข</p>
 <p>ค</p>	  <p>ง</p>

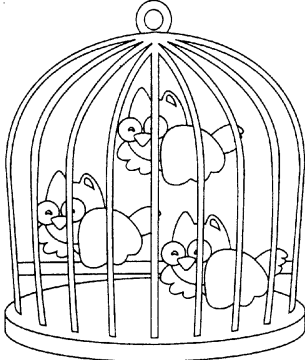

7 ฉันทึ่ยงนค 3 ตัว
นึบขาทงหมตไต้กึขาท

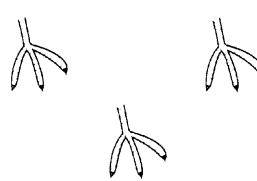
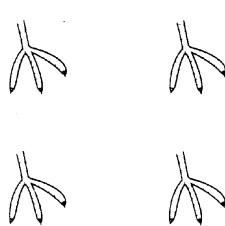
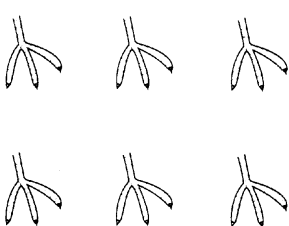
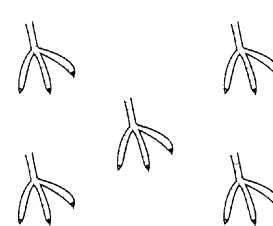

 <p>ก</p>	 <p>ข</p>
 <p>ค</p>	 <p>ง</p>

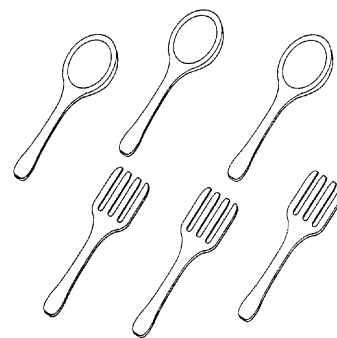

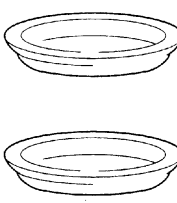
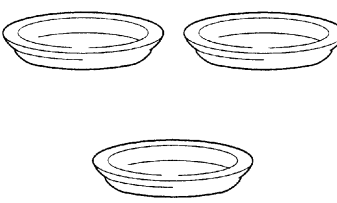
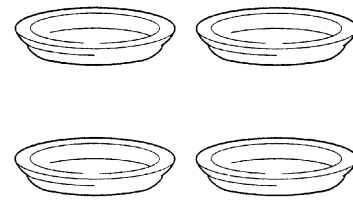
8 คุณแม่มึช้อนและส้อม
รวมแล้วนึบไต้ 6 อัน
เอาจึดใส่จัน จันละ 1 คู่
จจะต้งใส่จันกึบ

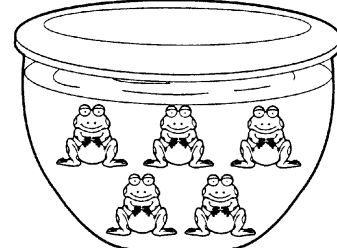

 <p>ก</p>	 <p>ข</p>
 <p>ค</p>	 <p>ง</p>

9 จึบคบใส่อ้งไต้ 5 ตัว
รุงเช้านึบคบไต้ 2 ตัว
คบหายไต้กึตัว

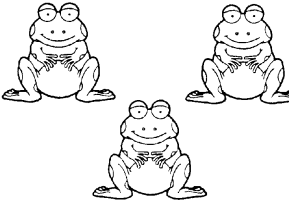
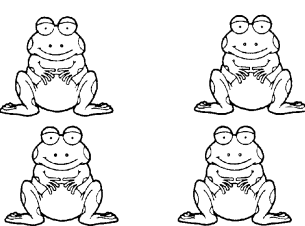

 <p>ก</p>	 <p>ข</p>
 <p>ค</p>	 <p>ง</p>

10 ฉันมีเงิน 5 บาท
ซื้อท็อฟฟี่เม็ดละ 1 บาท
ได้กี่เม็ด

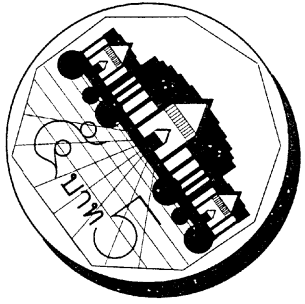

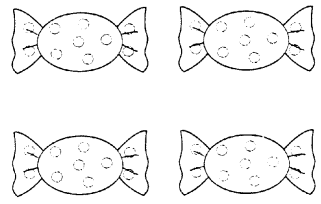
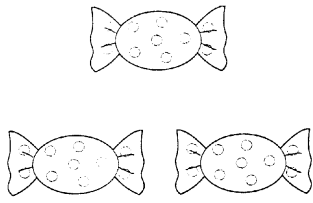
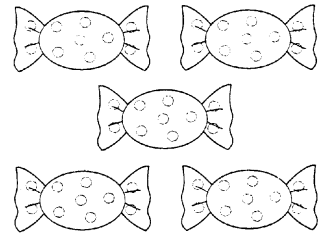
 <p>ก</p>	 <p>ข</p>
 <p>ค</p>	 <p>ง</p>

11 จัดผลไม้ใส่ตะกร้า 3 ชนิด
ชนิดละ 3 ผลให้มีจำนวน
เท่าๆ กัน ต้องหาผลไม้
ชนิดใดมาเพิ่มอีกเท่าไร

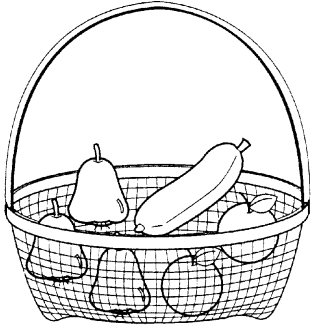

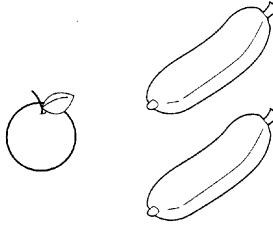
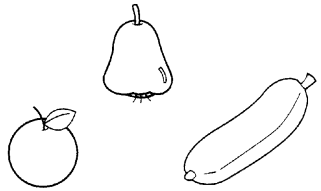
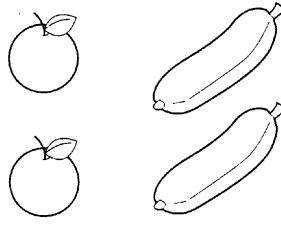
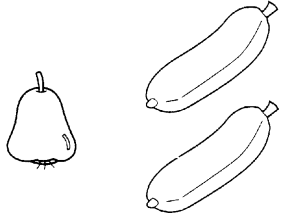
 <p>ก</p>	 <p>ข</p>
 <p>ค</p>	 <p>ง</p>

12 เลี้ยงแมวไว้ 3 ตัว สุนัข 2 ตัว
ต่อมาแมวตายไป 1 ตัว
สุนัขออกลูกมาอีก 3 ตัว
เวลานี้มีแมวและสุนัขกี่ตัว

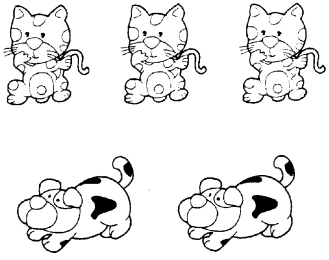

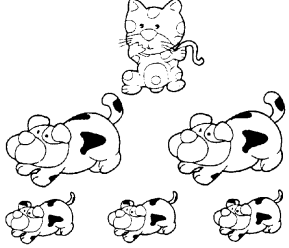
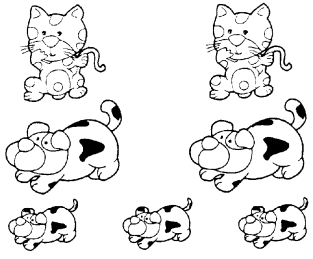
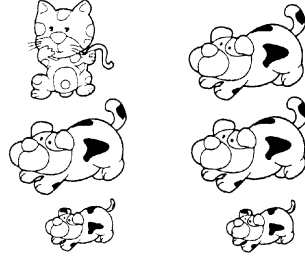
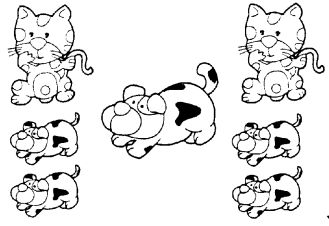
 <p>ก</p>	 <p>ข</p>
 <p>ค</p>	 <p>ง</p>

13

มีถ้วยกาแฟ 5 ใบ มีช้อนอยู่
3 คัน ทำถ้วยแตกไป 3 ใบ
แล้วซื้อช้อนมาเพิ่ม 4 คัน
จะมีถ้วย + ช้อน ทั้งหมดเท่าไร

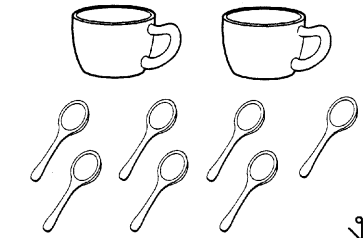
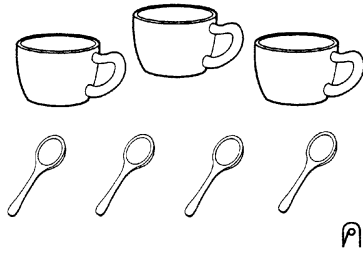
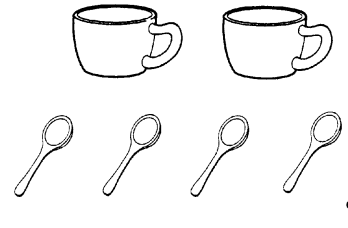
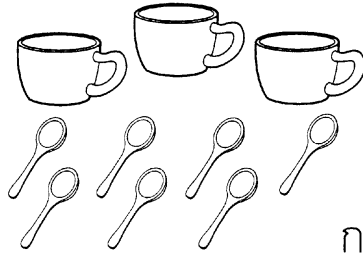
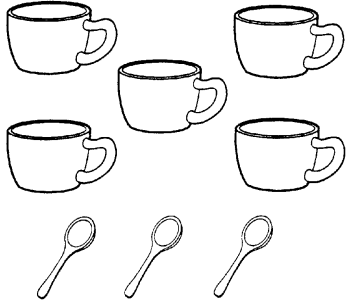

14

ในกล่องดินสอมีดินสอ 4 แท่ง
มียางลบ 2 ก้อน เอาดินสอ
ออกไปเหลา 1 แท่งและเอา
ยางลบมาใส่อีก 2 ก้อนในกล่อง
จะมีดินสอและยางลบเท่าไร

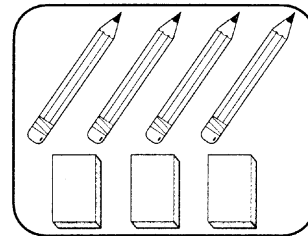
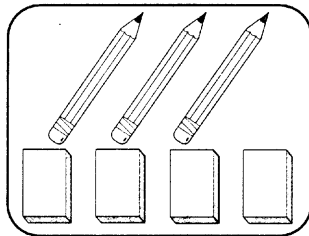
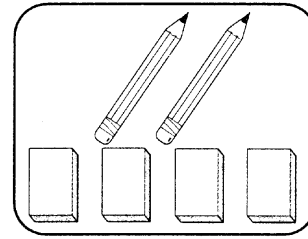
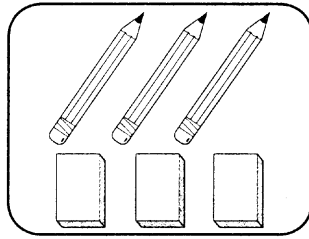
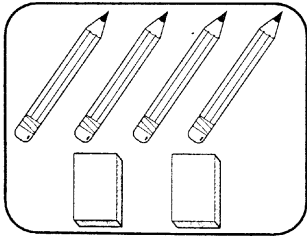

15

แจกันมีดอกไม้ 5 ดอก
เอาดอกเหี่ยวออกไป 4 ดอก
แล้วซื้อใหม่เพิ่มใหม่ 5 ดอก
ในแจกันจะมีดอกไม้กี่ดอก

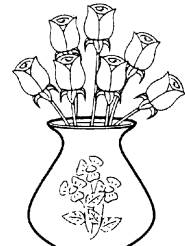
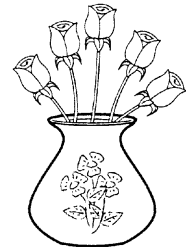
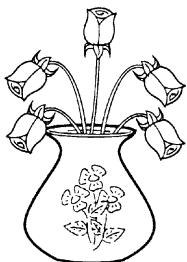

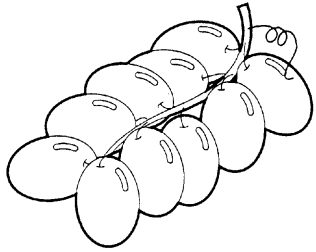

16 องุ่นพวงหนึ่งมี 10 ลูก
 นำไป 3 ลูก
 ให้นำไป 3 ลูก
 เหลือไว้กินเองกี่ลูก

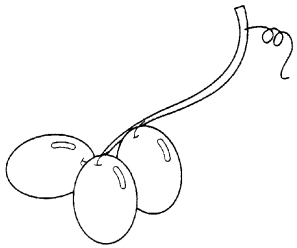
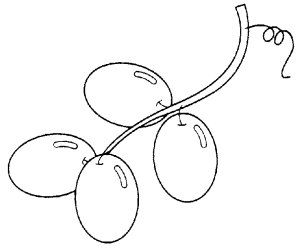
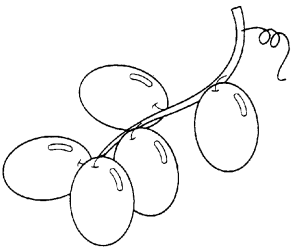
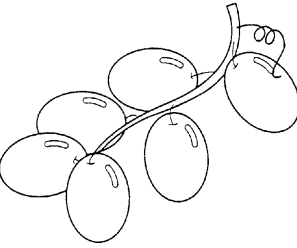

 ก	 ข
 ค	 ง

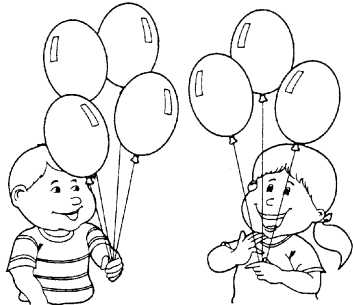
17 ฉันมีลูกโป่ง 3 ใบ
 เพื่อนให้มาอีก 4 ใบ
 ทำแตกไป 2 ใบ
 เหลือลูกโป่งกี่ใบ

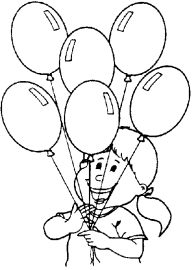

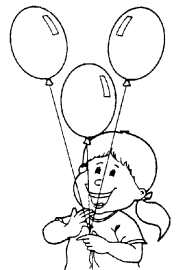
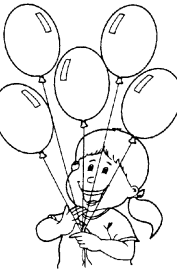
 ก	 ข
 ค	 ง

18 แม่ซื้อไข่มา 5 ฟอง ปลา 2 ตัว
 และมะเขือ 3 ผล เอาปลา ไข่
 และมะเขือมาทำกับข้าวกิน
 อย่างละ 2 ยังคงมีกับข้าว
 เหลืออีกจำนวนเท่าไร

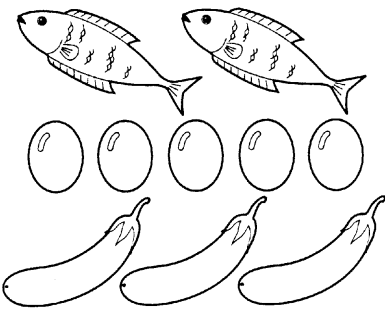

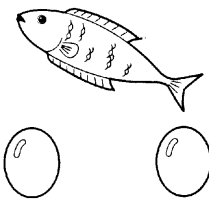
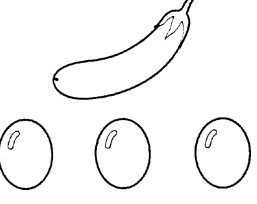
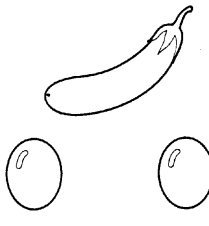
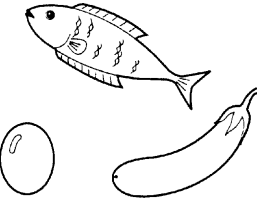
 ก	 ข
 ค	 ง

19

น้องวาดภาพ 🍏 3 บรรทัด
บรรทัดละ 2 ภาพ
ถ้าวาดเพิ่มบรรทัดละ 1 ภาพ
จะต้องวาดทั้งหมดกี่ภาพ

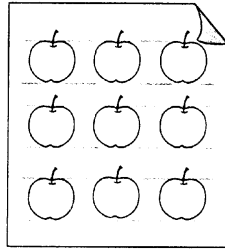
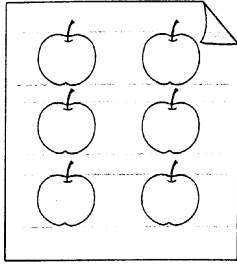

ก

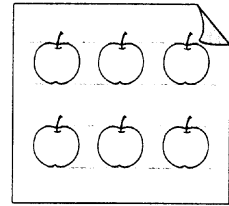

ข

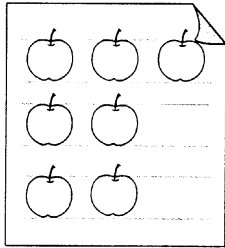

ค

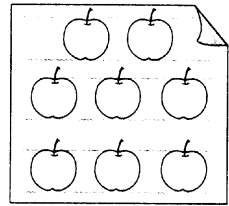

ง

20

มีโดนัท 4 ชิ้น คุกกี้ 3 ชิ้น
เอาไปกินอย่างละ 1 ชิ้น
จะเหลือกี่ชิ้น

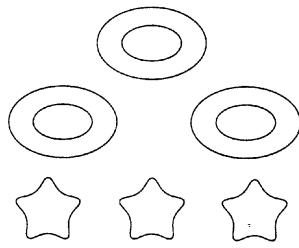
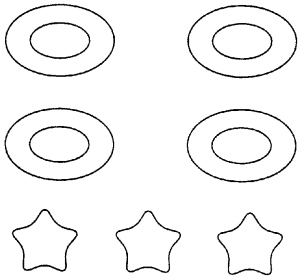

ก

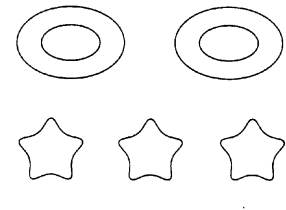

ข

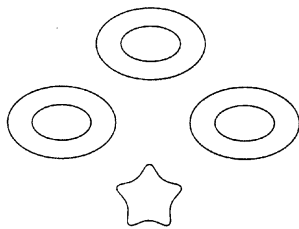

ค

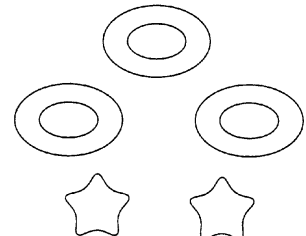

ง

21

มีมังคุด 5 ผลกับมะพร้าว
อีก 2 ลูก กินมังคุดไป 3 ผล
แล้วซื้อมะพร้าวมาเพิ่ม 1 ลูก
จะมีผลไม้แต่ละชนิดเหลือ
ไว้กินเท่าไร

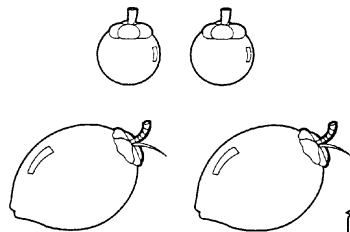
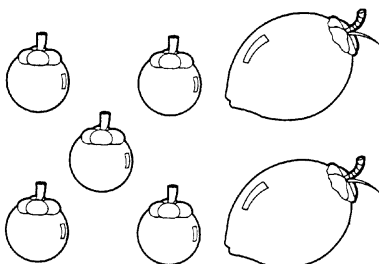

ก

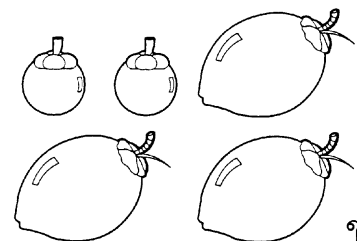

ข

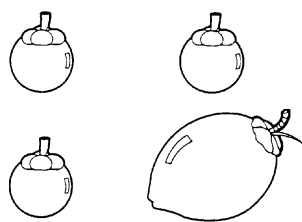

ค

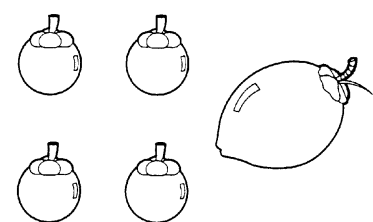

ง

22 มีเรือจอดเทียบท่าอยู่ 7 ลำ
ต่อมาวิ่งออกทะเลไป 3 ลำ
จะมีเรือเหลือกี่ลำ

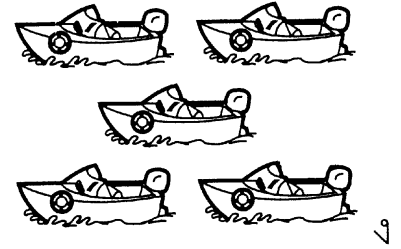
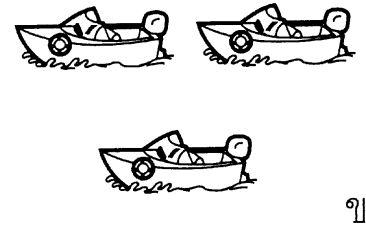
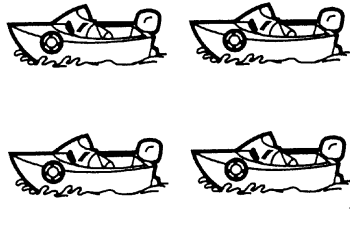
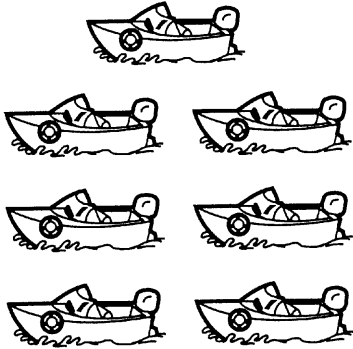

23 มีตุ๊กตาหิมะอยู่ 6 ตัว
ต่อมาละลายไป 3 ตัว
ต้องปั้นเพิ่มกี่ตัวจึงจะ
เท่าเดิม

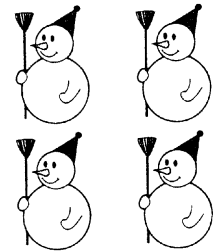
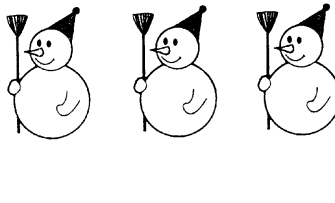
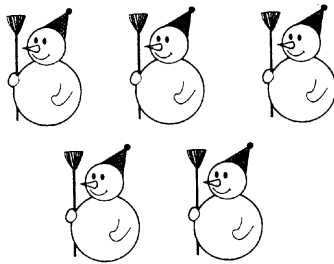
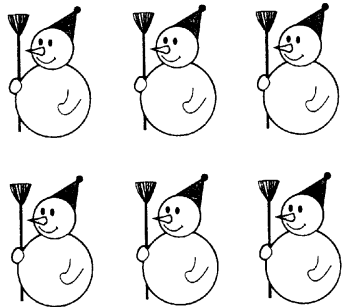

24 มีกุ้ง 5 ตัว มีปู 3 ตัว
ต้องซื้อปูมาเพิ่มอีกกี่ตัว
จึงจะมีจำนวนเท่ากัน

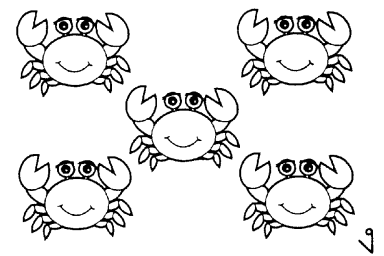
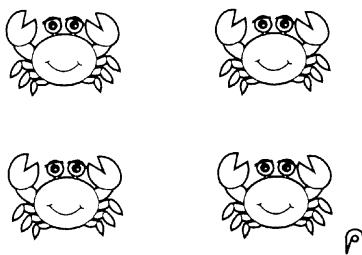
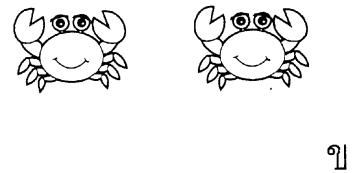
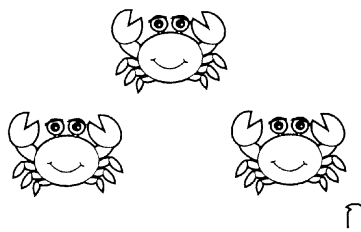
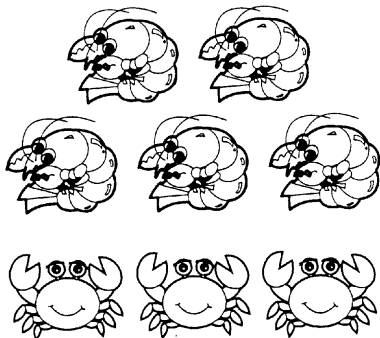

25 มีนกเกาะอยู่บนกิ่งไม้ 4 ตัว
บินออกไป 2 ตัวจะเหลือนกบนกิ่งไม้กี่ตัว

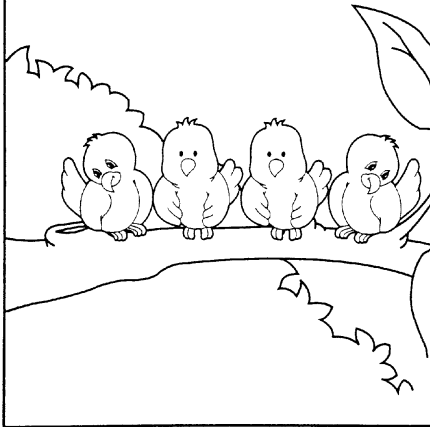

ก



ข

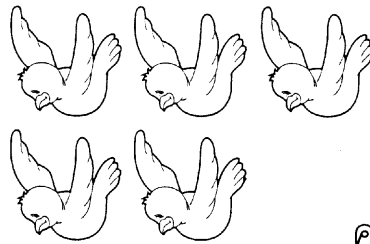

ค

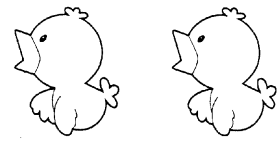

ง

26 แม่มีแอปเปิ้ล 5 ผล
เสียไป 2 ผล ตอนนี้แม่จะเหลือแอปเปิ้ลกี่ผล

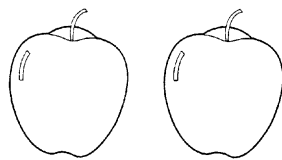
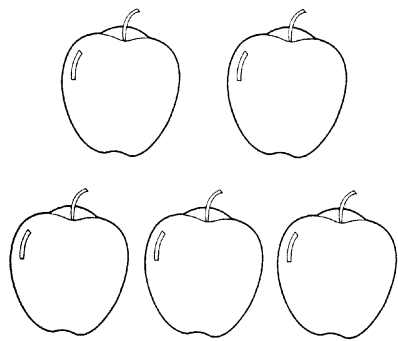

ก

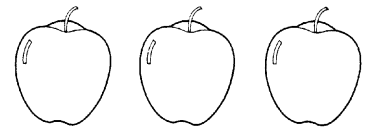

ข

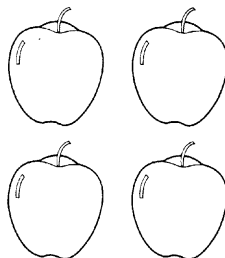

ค

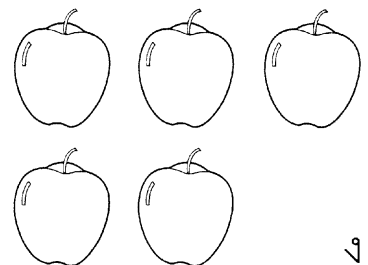

ง

27 พี่มีดินสออยู่ 6 แท่ง
ซื้อเพิ่มอีก 3 แท่ง
พี่จะมีดินสออยู่ที่แท่ง

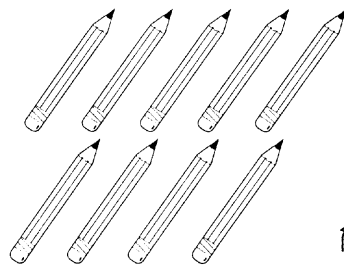
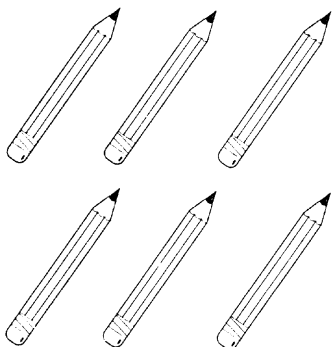

ก

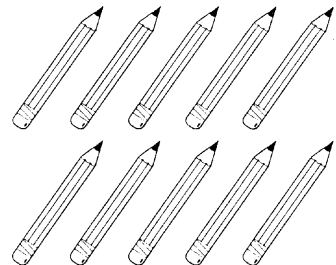

ข

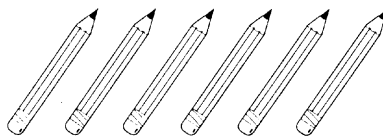

ค

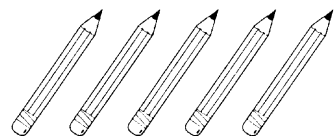

ง

28

ทุเรียนต้นหนึ่งออกลูกมา
7 ลูกเก็บไปขาย 4 ลูก
จะเหลือทุเรียนอยู่บนต้น
กี่ลูก

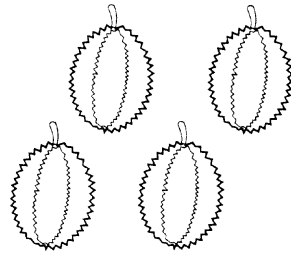
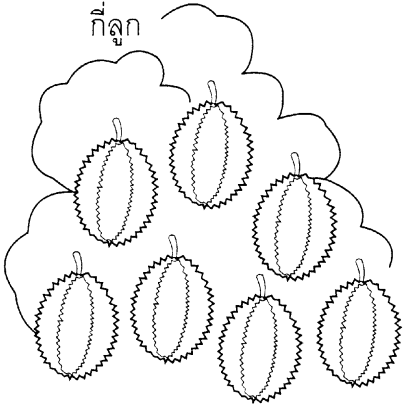

ก

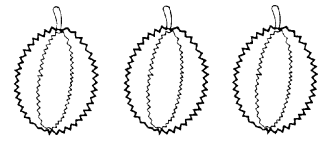

ข

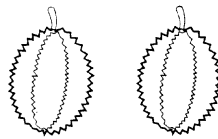

ค

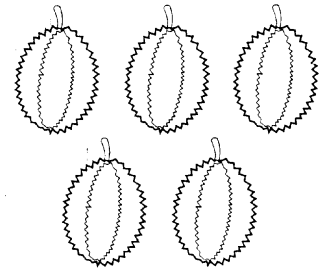

ง

29

พ่อเลี้ยงแกะ 8 ตัว
ออกลูกมา 3 ตัวตอนนี้
พ่อมีแกะอยู่ที่ตัว

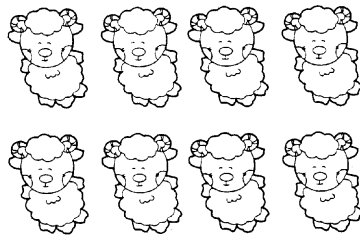
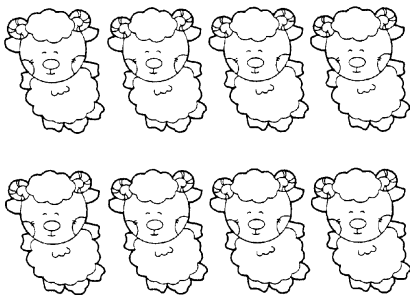

ก

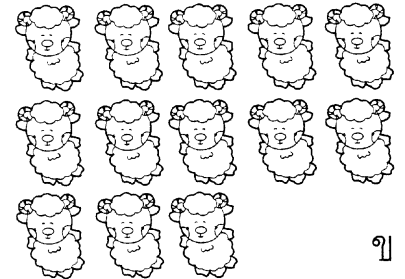

ข

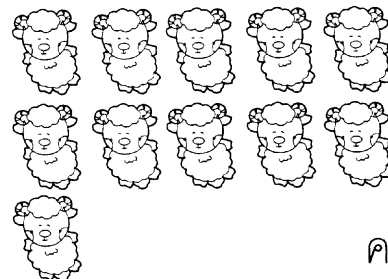

ค

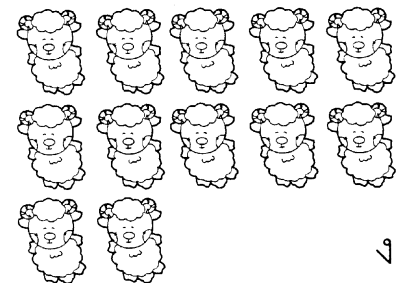

ง

30

มีวัวอยู่ 5 ตัว มีเต่า 2 ตัว
จะมีวัวมากกว่าเต่ากี่ตัว

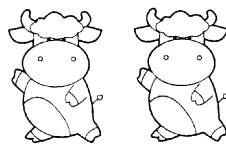
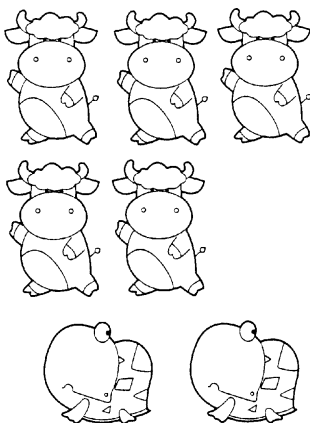

ก

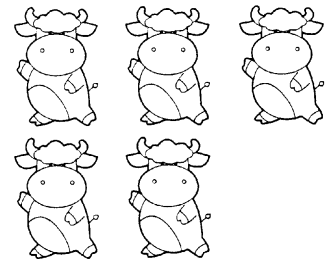

ข



ค

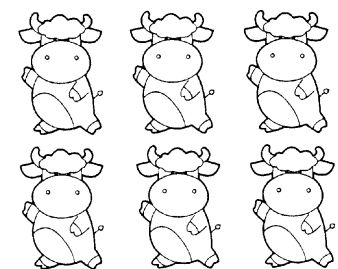

ง

จงนับจำนวนกล่องสีขาวที่สัมผัสกับกล่องสีเทาแล้ว X ข้อที่ถูก

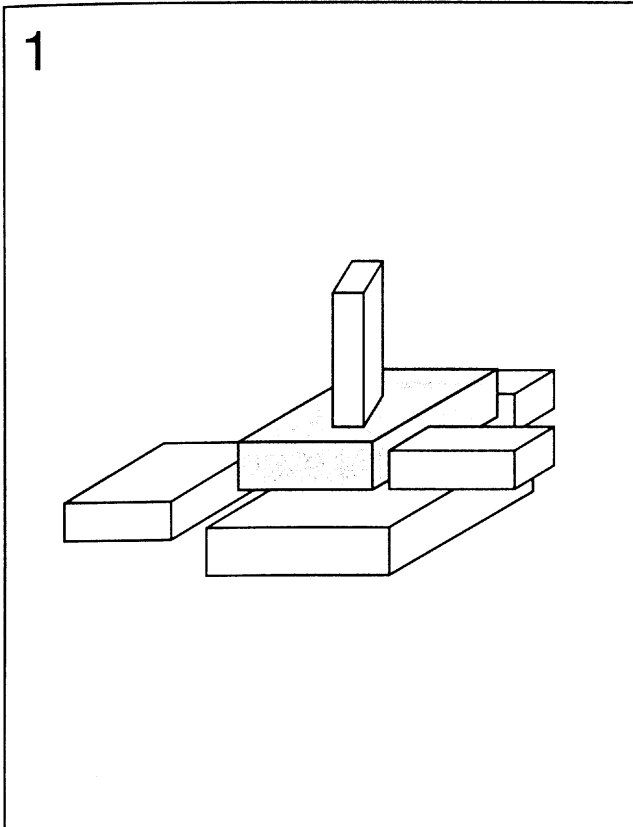

ก 5 ข 4 ค 3 ง 2

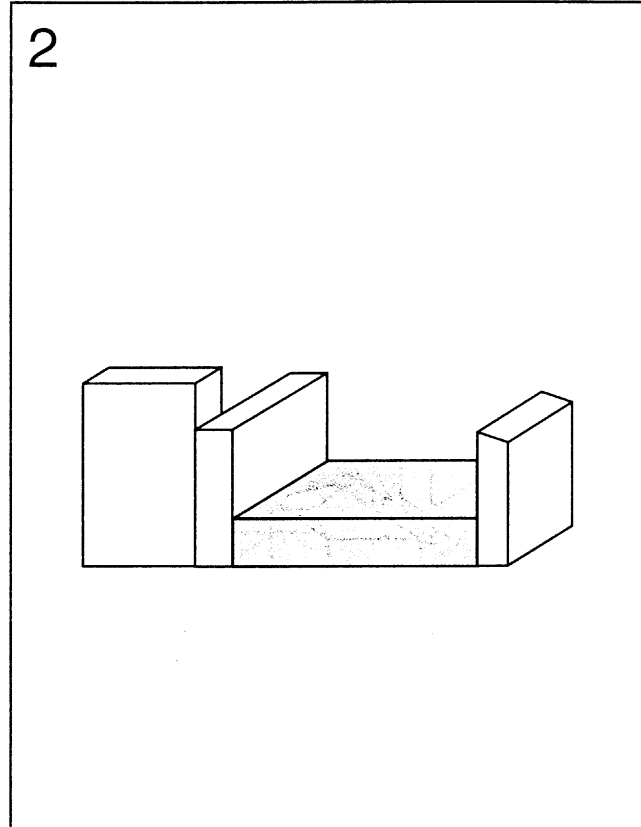

ก 1 ข 4 ค 3 ง 2

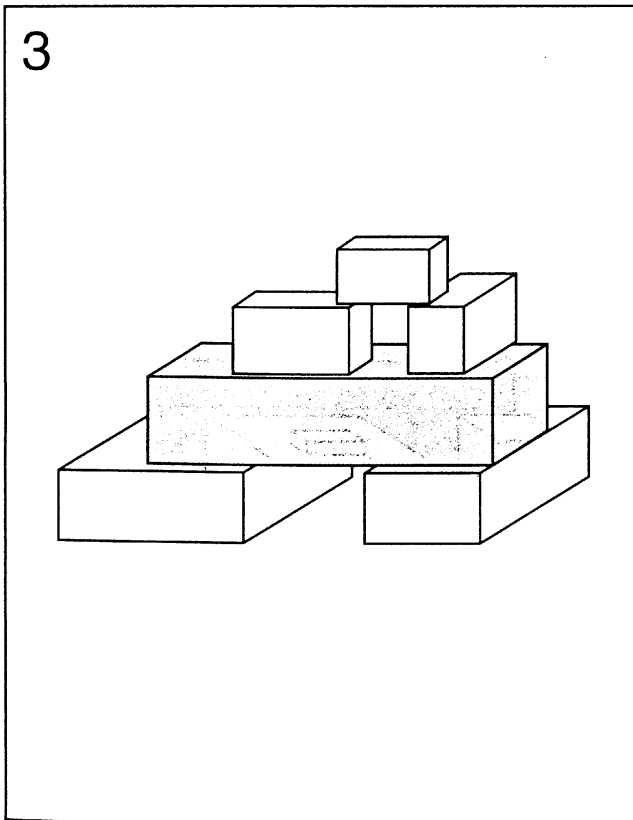

ก 2 ข 4 ค 3 ง 5

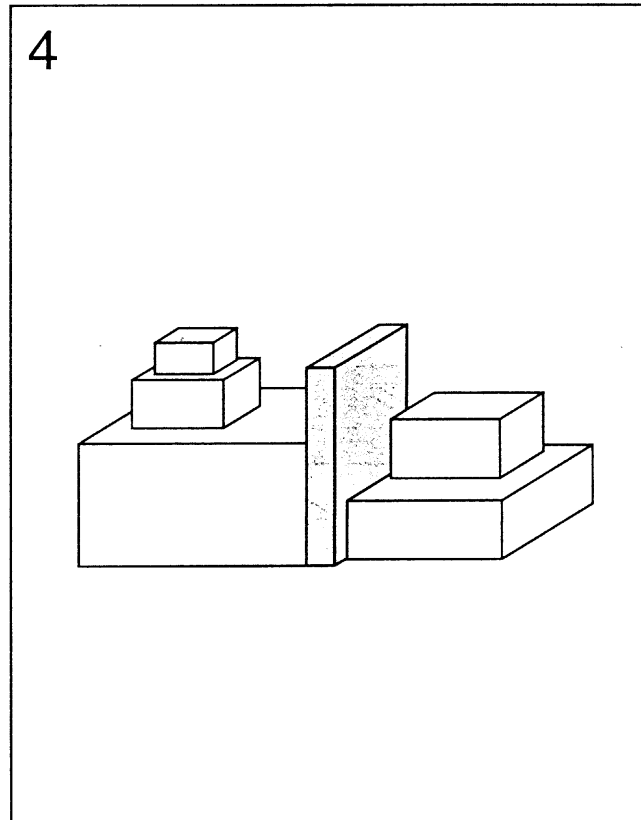

ก 3 ข 4 ค 2 ง 5

5

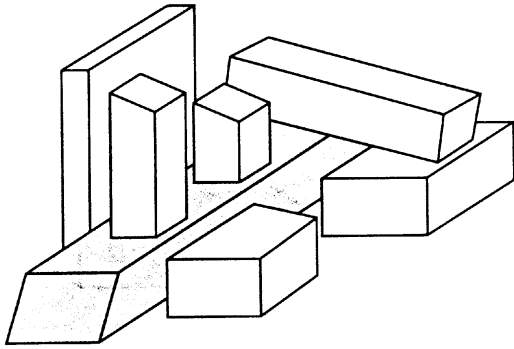

ก 3 ข 4 ค 5 ง 6

6

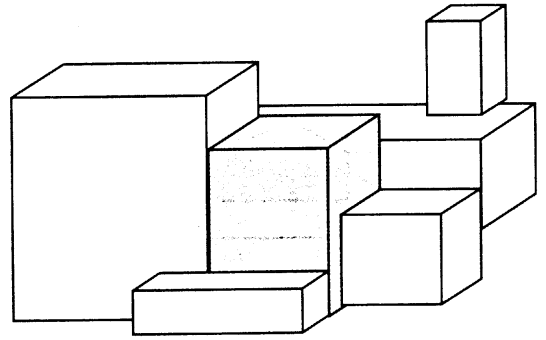

ก 6 ข 5 ค 4 ง 3

7

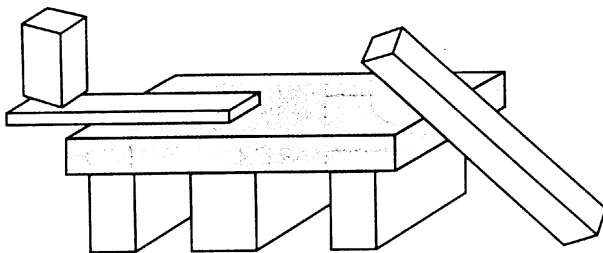

ก 3 ข 4 ค 6 ง 5

8

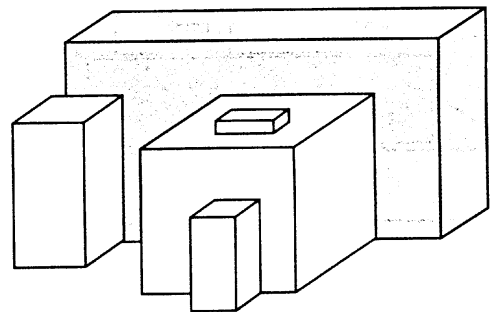

ก 5 ข 4 ค 3 ง 2

9

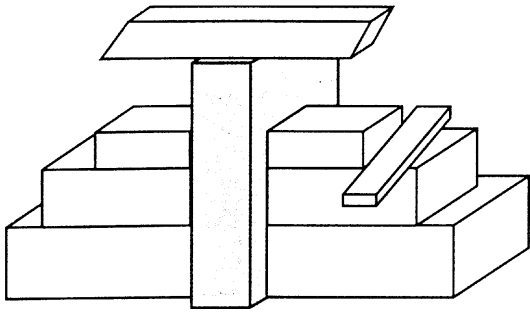

ก 5 ข 6 ค 7 ง 8

10

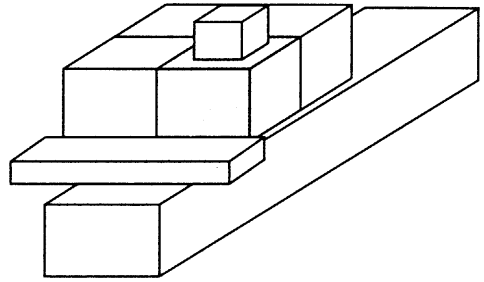

ก 5 ข 6 ค 7 ง 8

11

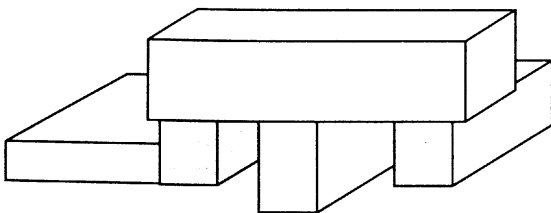

ก 4 ข 2 ค 3 ง 1

12

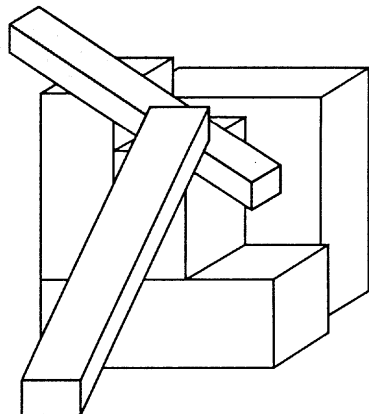

ก 3 ข 2 ค 5 ง 4

13

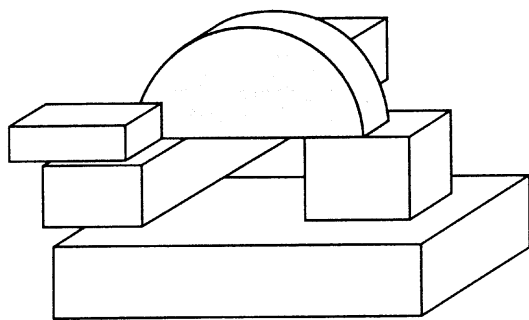

ก 2 ข 3 ค 4 ง 1

14

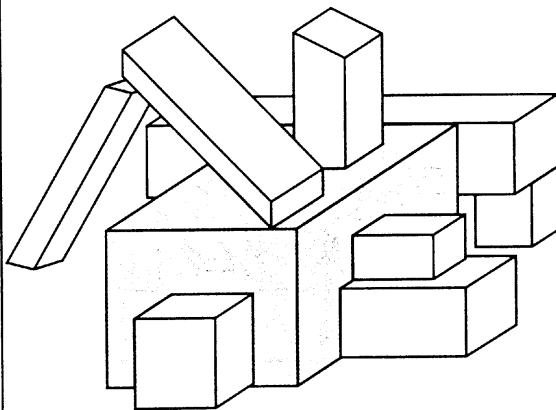

ก 7 ข 6 ค 4 ง 5

15

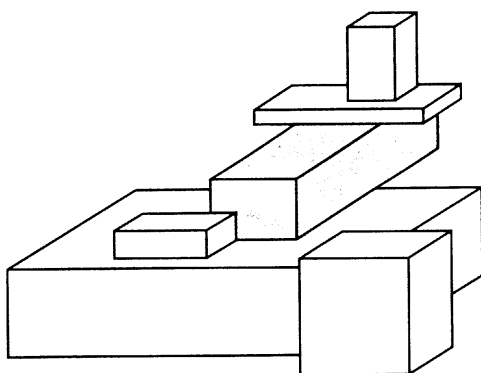

ก 3 ข 2 ค 5 ง 4

16

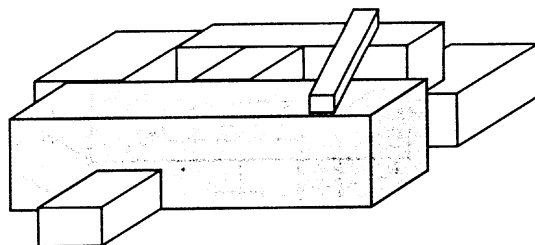

ก 3 ข 2 ค 4 ง 5

17

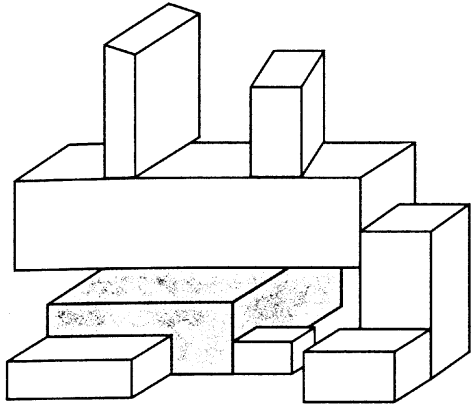

ก 5 ข 4 ค 3 ง 2

18

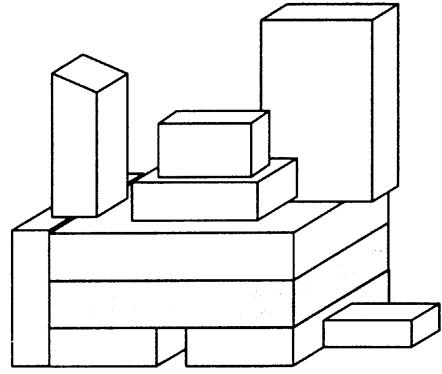

ก 1 ข 4 ค 3 ง 2

19

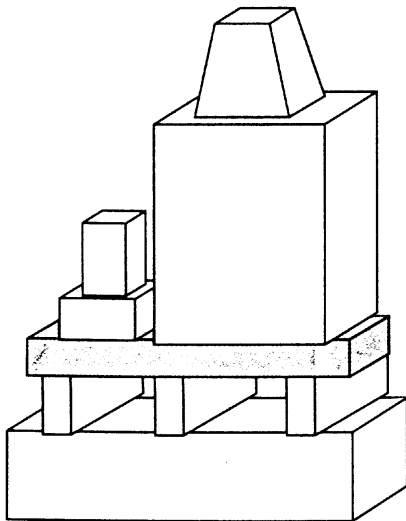

ก 2 ข 4 ค 3 ง 5

20

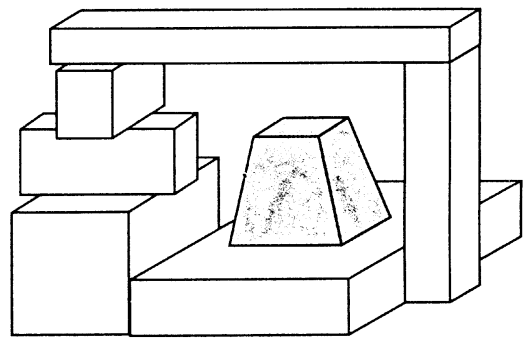

ก 1 ข 3 ค 2 ง 4

จงขีด ✓ ข้อที่มีสัตว์ตรงกับจำนวนรอยเท้าในช่องแรก

<p>1</p>	<p>ก</p>	<p>ข</p>
	<p>ค</p>	<p>ง</p>

<p>2</p>	<p>ก</p>	<p>ข</p>
	<p>ค</p>	<p>ง</p>

<p>3</p>	<p>ก</p>	<p>ข</p>
	<p>ค</p>	<p>ง</p>

4

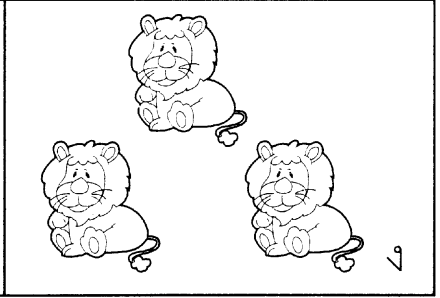
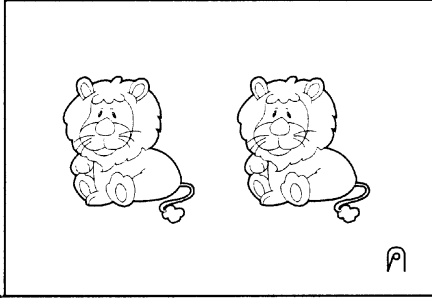
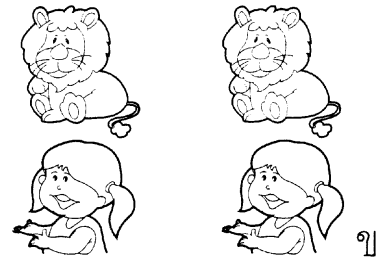
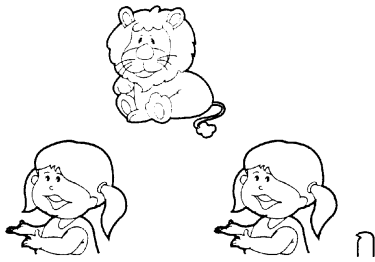
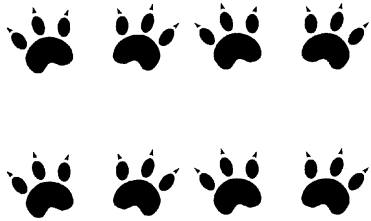

5

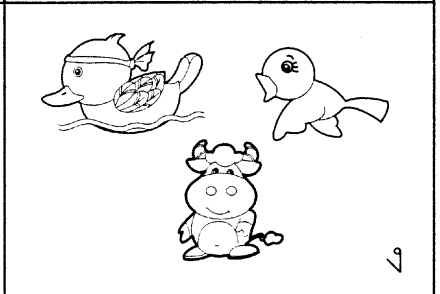
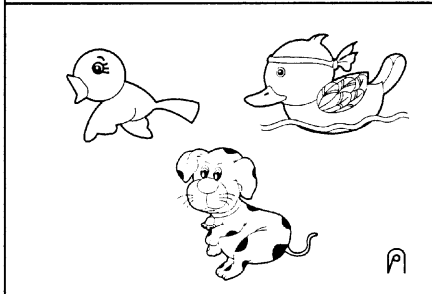
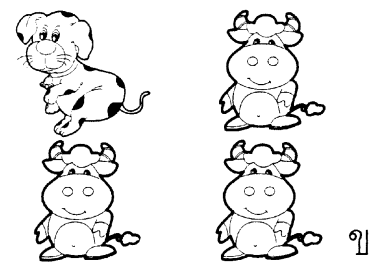
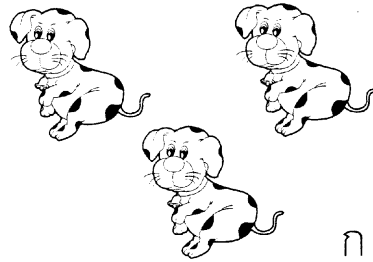
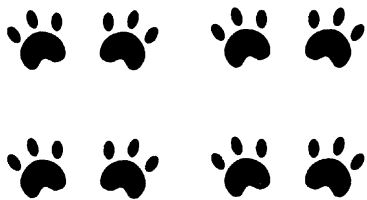

6

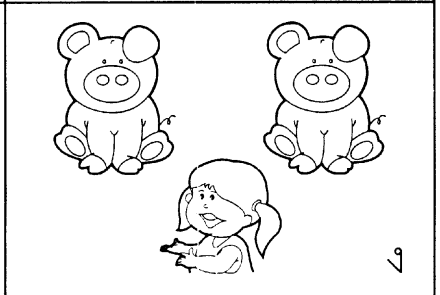
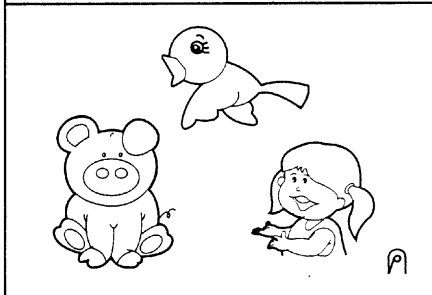
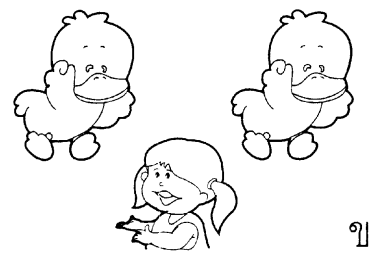
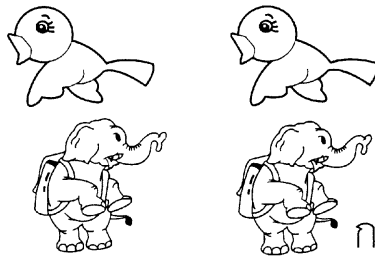

7

8

9

10

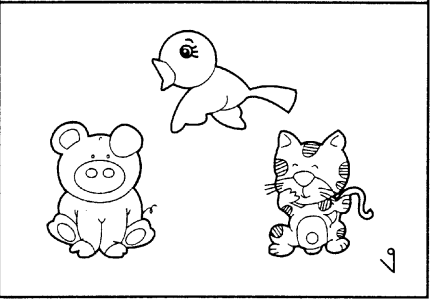
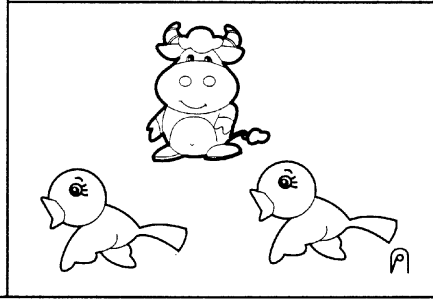
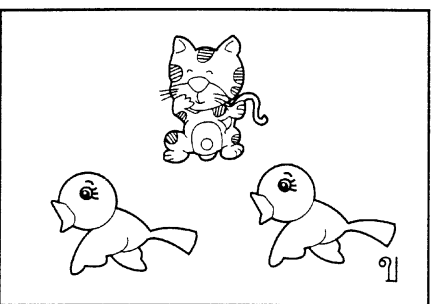
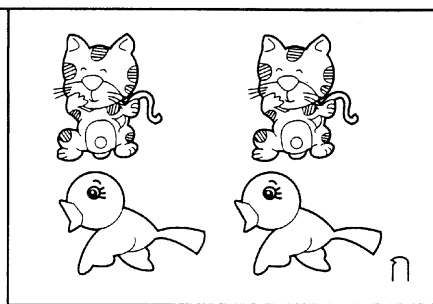
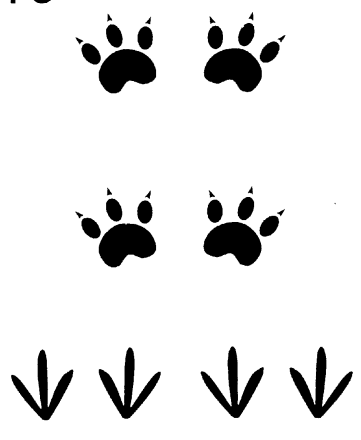

11

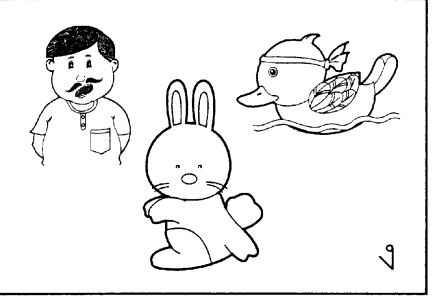
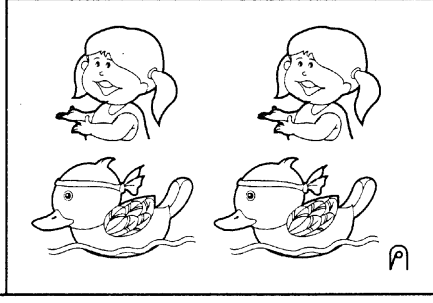
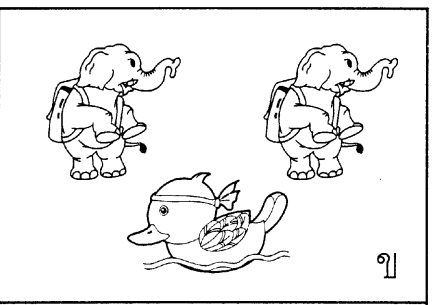
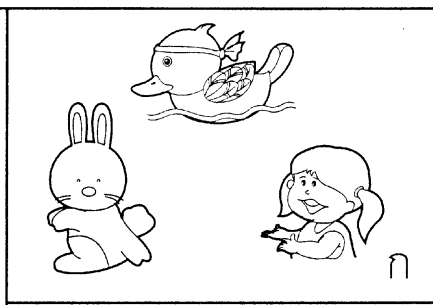

12

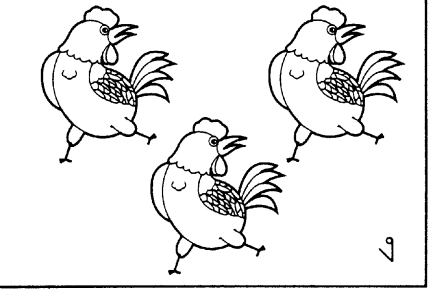
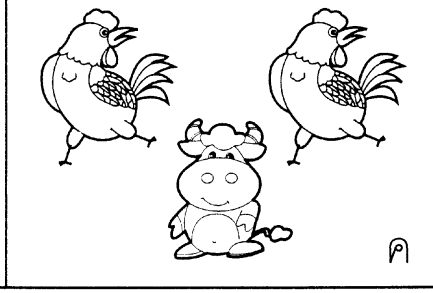
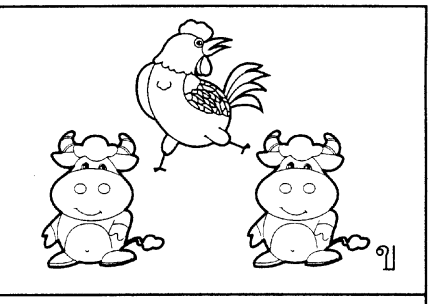
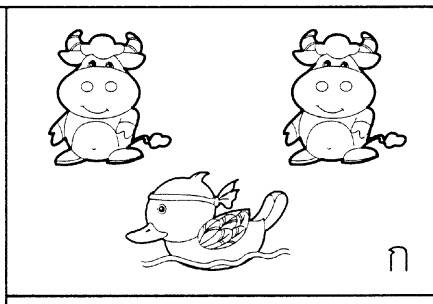

13

Two sets of footprints, each with two prints. Below them are two sets of two downward-pointing arrows.

14

Two sets of paw prints, each with two prints. Below them are two sets of two downward-pointing arrows.

15

Two sets of wings, each with two prints. Below them are two sets of two downward-pointing arrows.

จงขีด ✓ ข้อที่มีภาพต่อเนื่องที่นำมาเติมในช่องว่างได้

1

Row 1: Large triangle, Small triangle, Large square, Small square, Large triangle, Small triangle, Small triangle, Large square, —, —

Row 2: Small square, Large triangle, Small square, Small square, Large square, Small square, Small square, Large square, —, —

Options: ก, ข, ค, ง

2

Row 1: Up arrow, Up arrow, Down arrow, Right arrow, Right arrow, Left arrow, Down arrow, —, —

Row 2: Up arrow, Down arrow, Up arrow, Up arrow, Down arrow, Up arrow, Down arrow, Down arrow, —, —

Options: ก, ข, ค, ง

3

Row 1: Circle with diagonal lines, Circle, Circle, Square, Square, Square with diagonal lines, Circle with diagonal lines, Circle, —, —, —

Row 2: Circle, Square, Square with diagonal lines, Circle with diagonal lines, Square, Square, Circle, Square, Square with diagonal lines, Circle, Square, Square, —, —, —

Options: ก, ข, ค, ง

4

Row 1: Oval with black dot at top-left, Oval with black dot at top-right, Oval with black dot at bottom-left, Oval with black dot at bottom-right, Oval with black dot at top-left, Oval with black dot at top-right, Oval with black dot at bottom-left, Oval with black dot at bottom-right, Oval with black dot at top-left, Oval with black dot at top-right, —, —, —

Row 2: Oval with black dot at top-left, Oval with black dot at bottom-left, Oval with black dot at top-right, Oval with black dot at top-left, Oval with black dot at bottom-left, Oval with black dot at top-right, Oval with black dot at top-left, Oval with black dot at bottom-left, Oval with black dot at top-right, Oval with black dot at top-left, Oval with black dot at bottom-left, Oval with black dot at top-right, —, —, —

Options: ก, ข, ค, ง

5

1 2 3 3 4 5 5 _ _ _

677 677 677 678

ก

ข

ค

ง

6



ก

ข

ค

ง

7

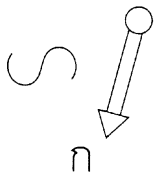
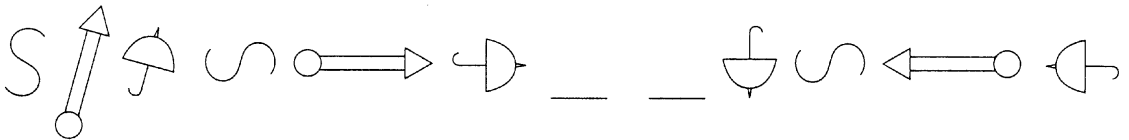

ก

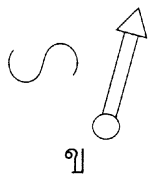

ข

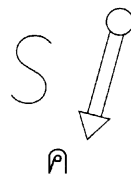

ค

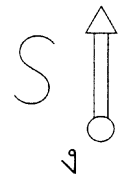

ง

8



ก



ข



ค



ง

9

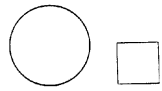
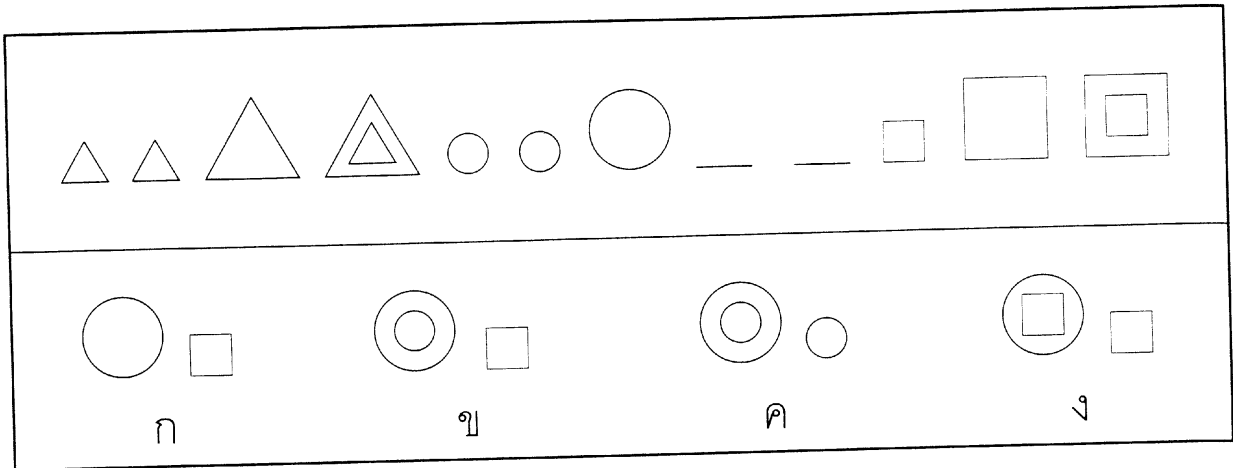

ก

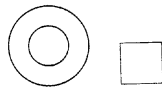

ข

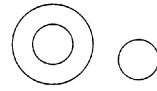

ค

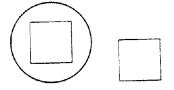

ง

10

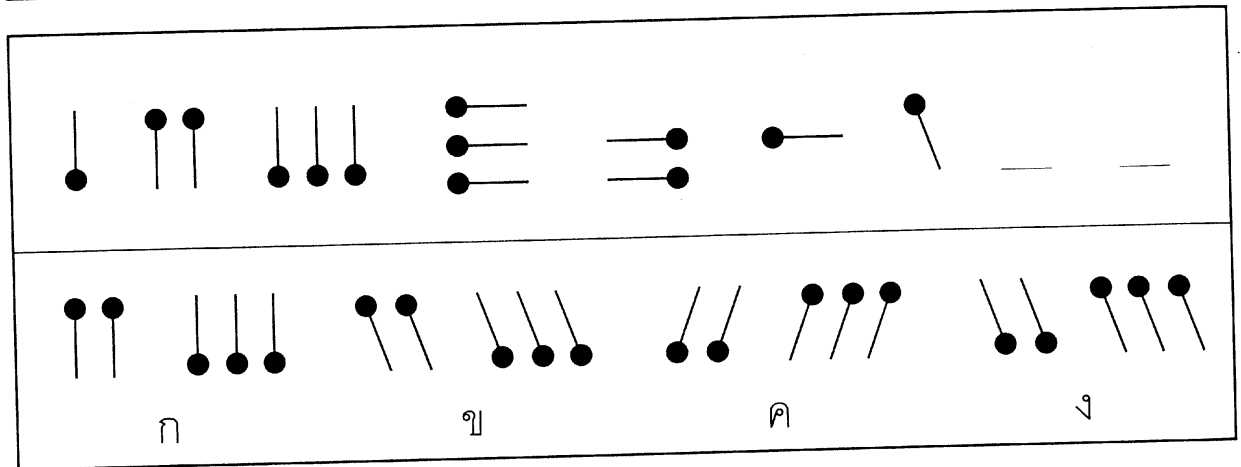

ก



ค



ง

11

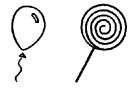
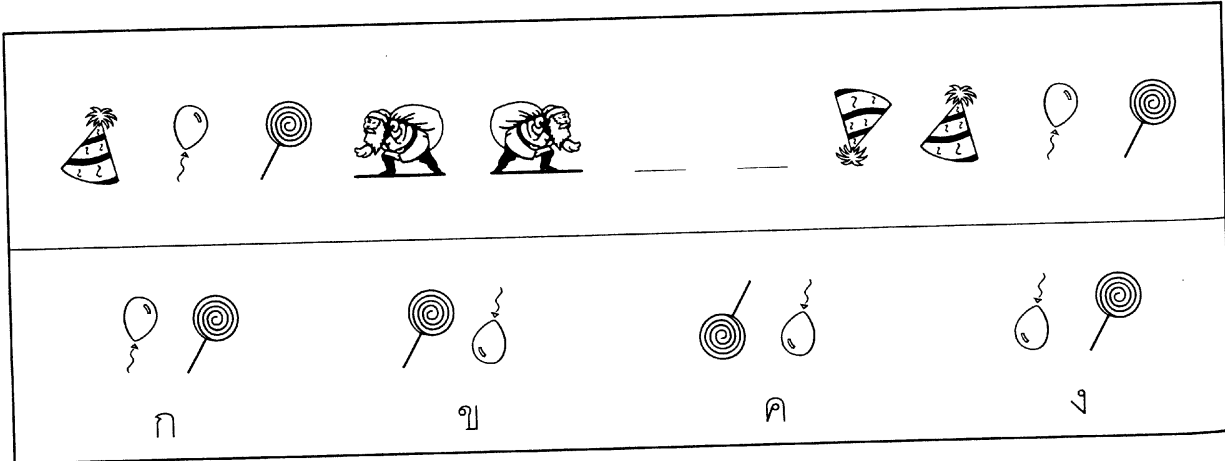

ก



ข

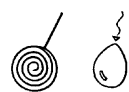

ค



ง

12

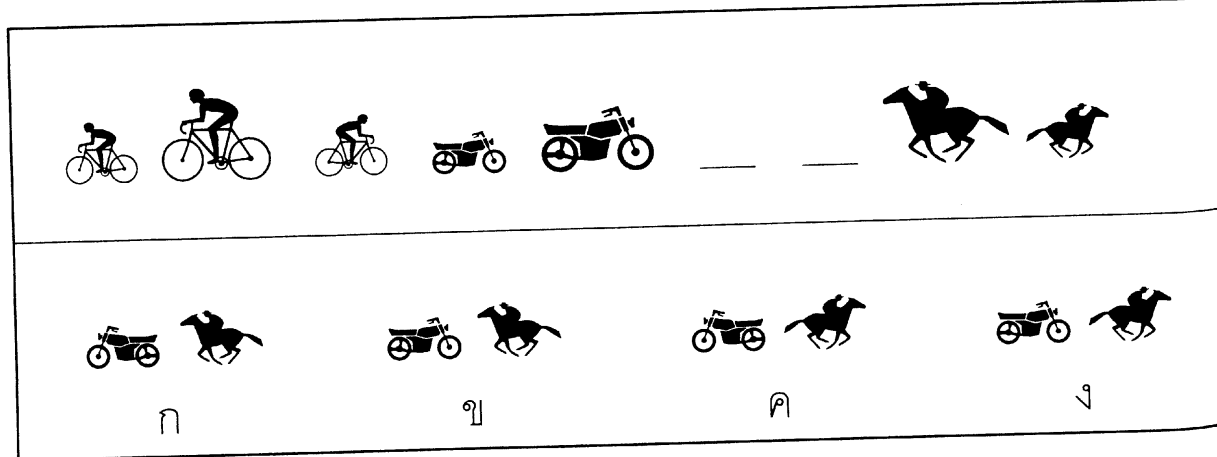

ก



ข



ค



ง

13

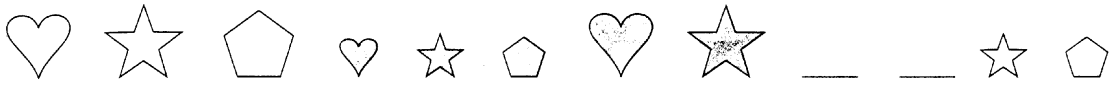

ก

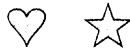

ข

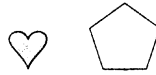

ค



ง

14

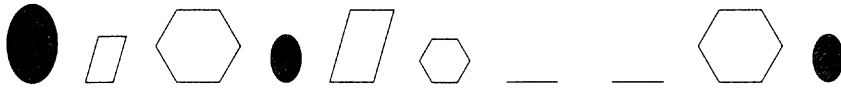

ก



ข



ค



ง

15

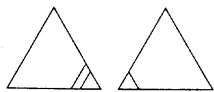
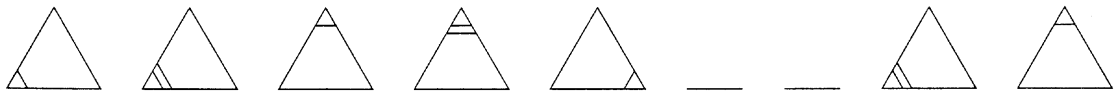

ก

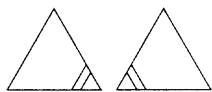

ข

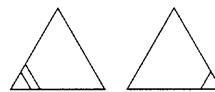

ค

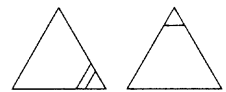

ง

16

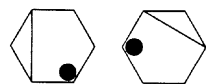
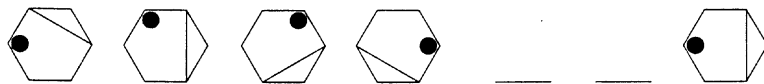

ก

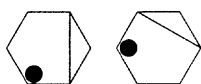

ข

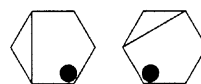

ค

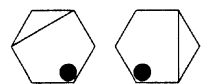

ง

17

၈ ၉ ၁၀ ၁၁

18

၈ ၉ ၁၀ ၁၁

19

၈ ၉ ၁၀ ၁၁

20

၈ ၉ ၁၀ ၁၁

จงเติมจุดในรูป ให้ถูกต้อง

1	2	3	4

5

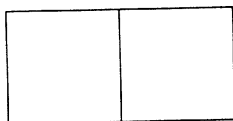
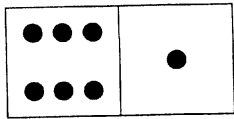
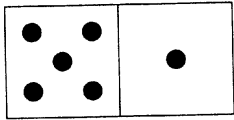
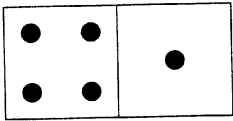
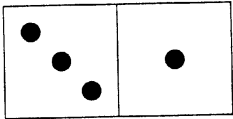
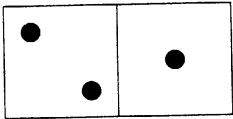

6

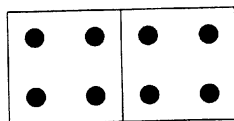
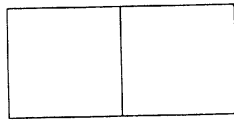
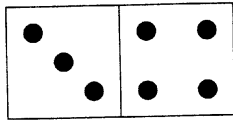
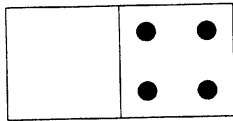
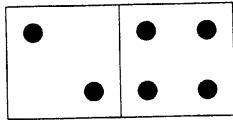
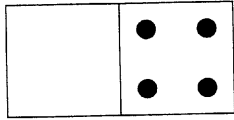

7

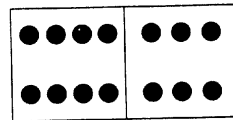
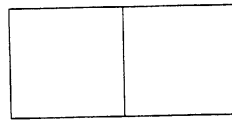
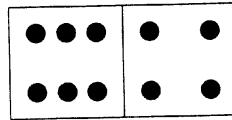
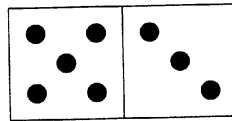
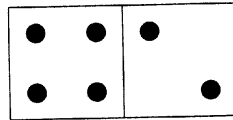
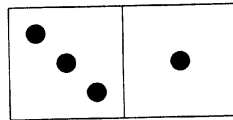

8

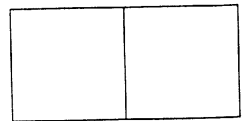
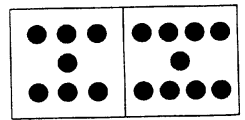
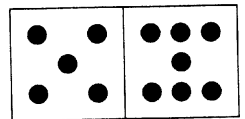
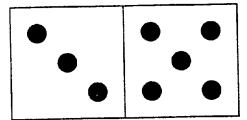
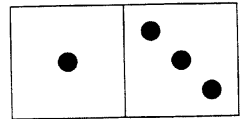
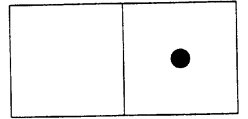

9

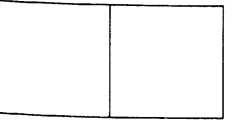
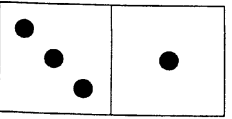
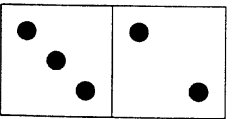
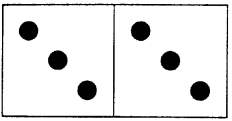
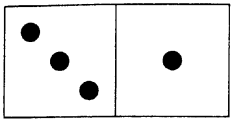
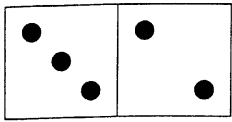

10

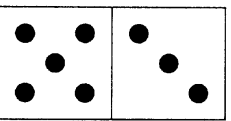
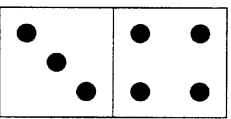
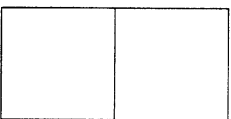
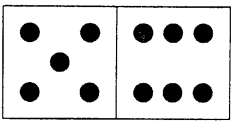
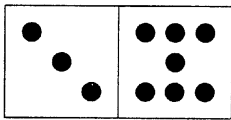
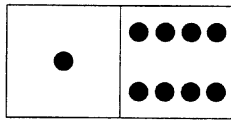

11

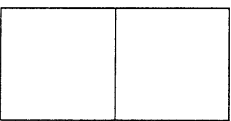
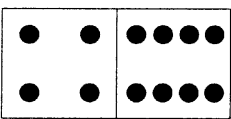
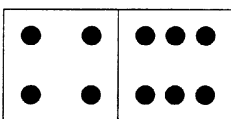
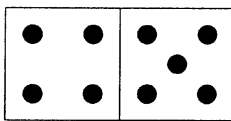
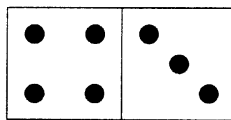
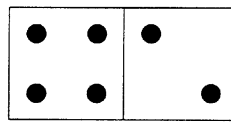

12

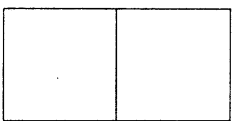
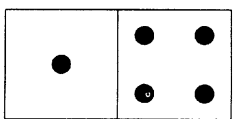
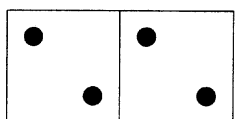
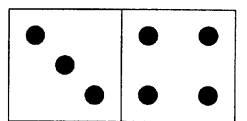
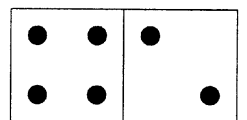
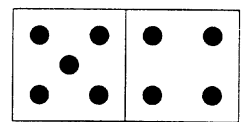

13

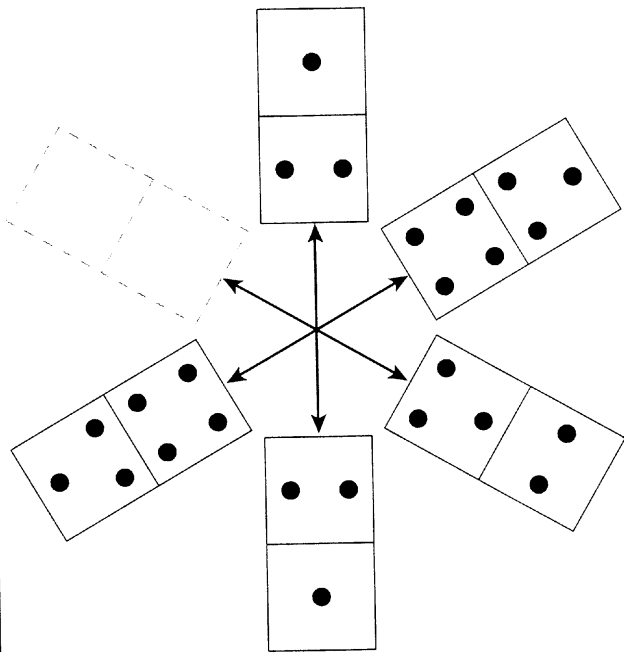

14

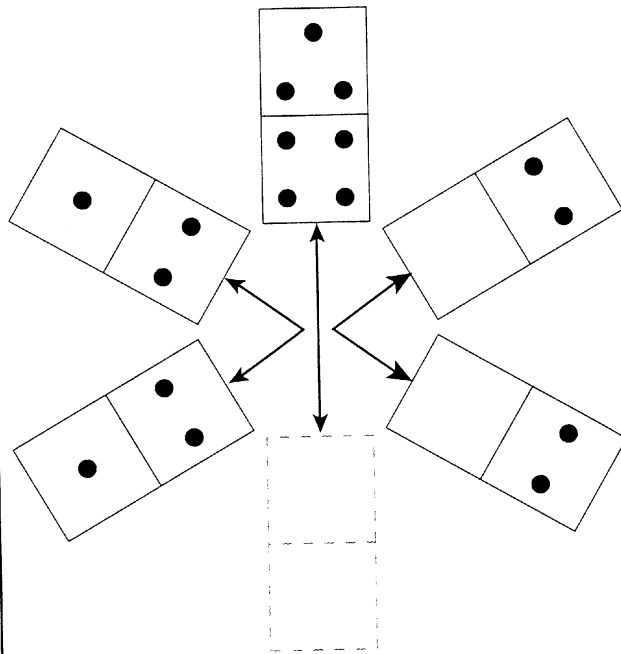

15

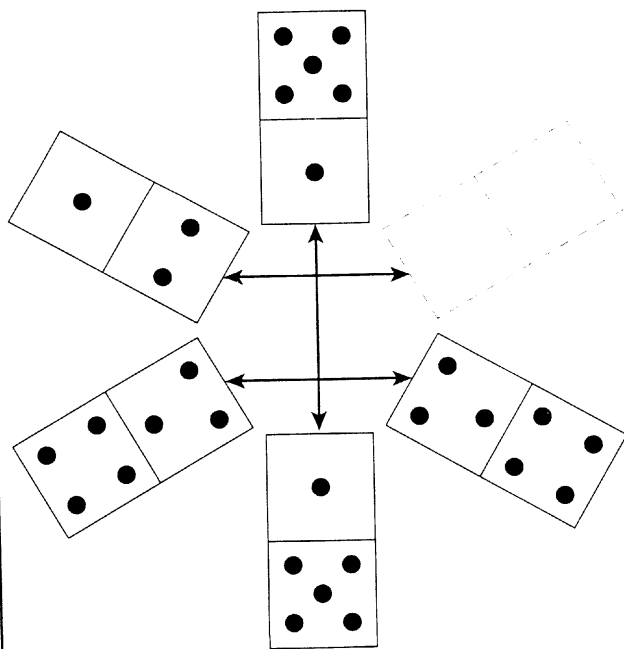

16

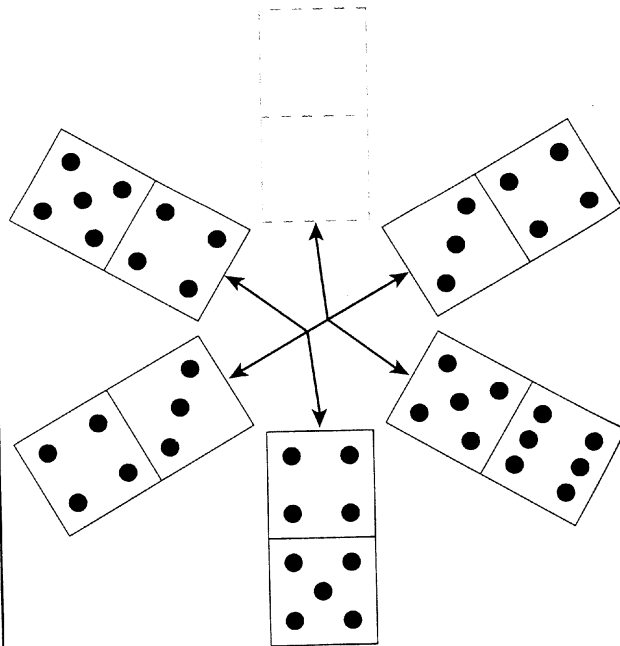

17

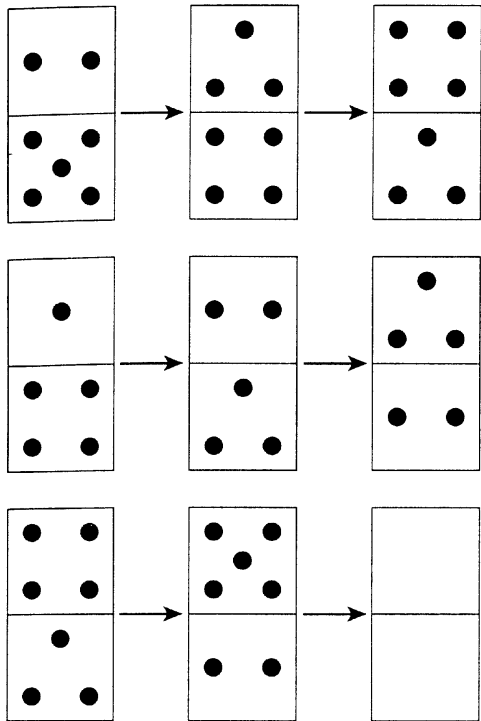

18

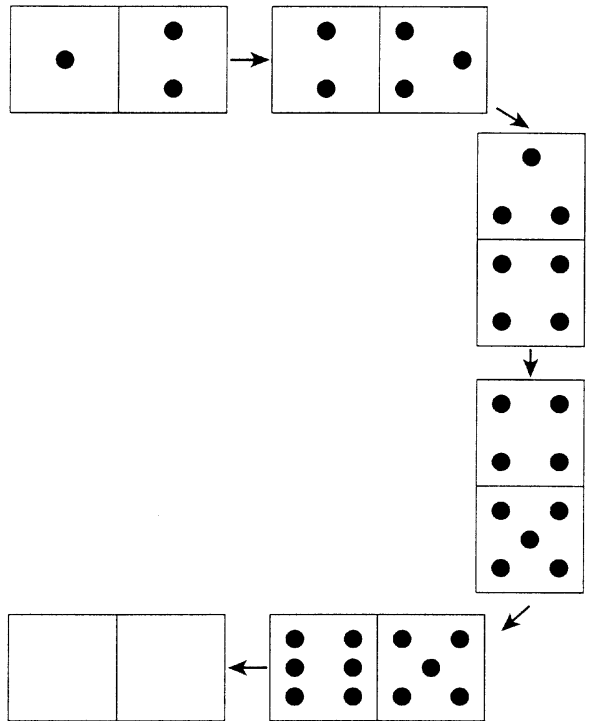

19

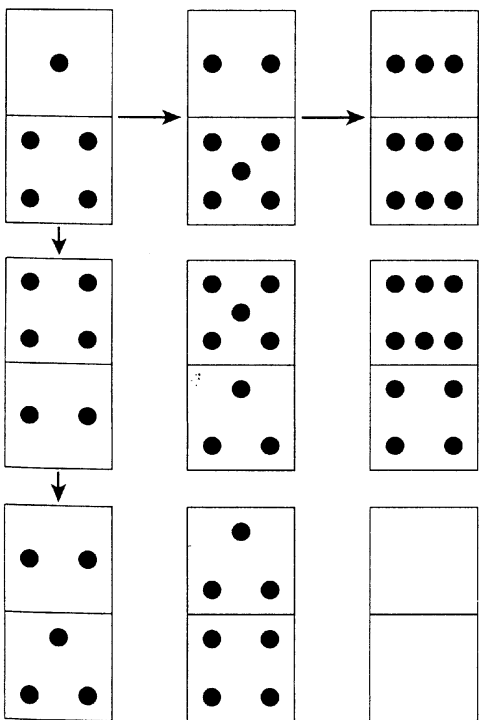

20

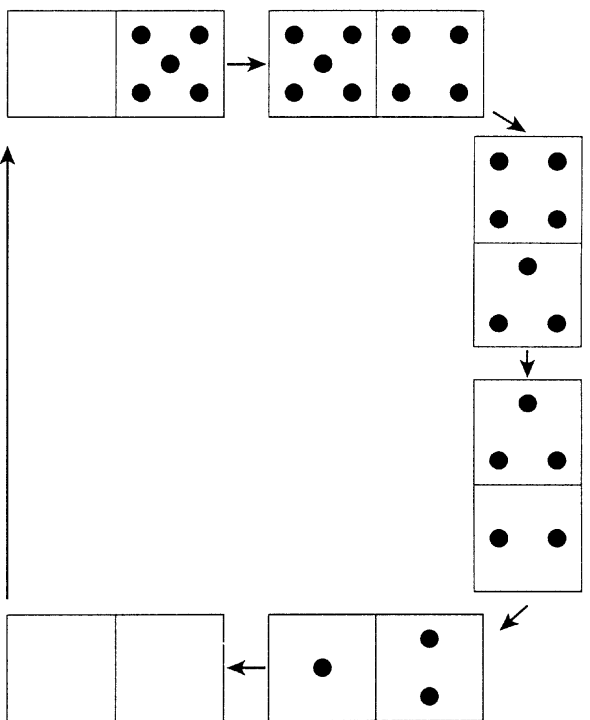

หาความสัมพันธ์ของปริมาณน้ำที่กำหนดในภาพแรก โดย ✓

1 ภาพใดแสดงการรินน้ำจากแก้วลงในอ่างอย่างถูกต้องวิธี

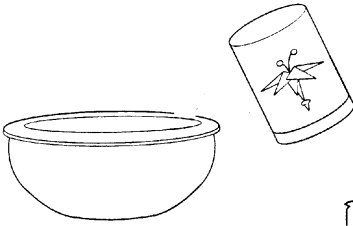
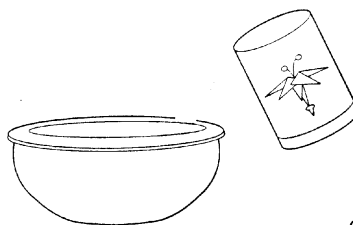

 <p>ก</p>	 <p>ข</p>
 <p>ค</p>	 <p>ง</p>

2 น้ำในแก้ว ข้อใดเท่ากับภาพแรก

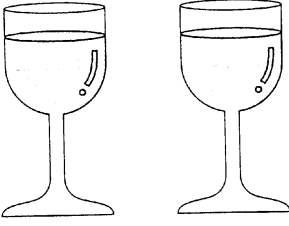

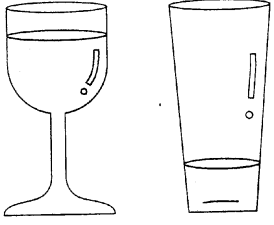
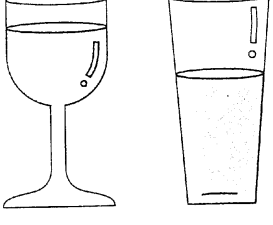
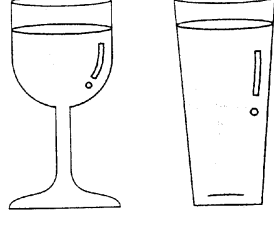
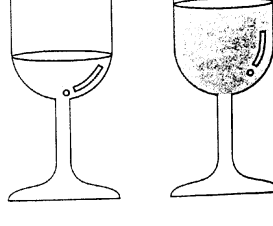
 <p>ก</p>	 <p>ข</p>
 <p>ค</p>	 <p>ง</p>

3 น้ำในแก้ว ข้อใดมีปริมาณเท่ากับภาพแรก

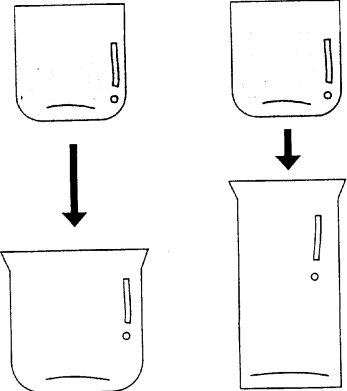

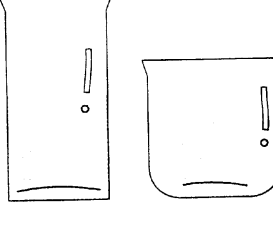
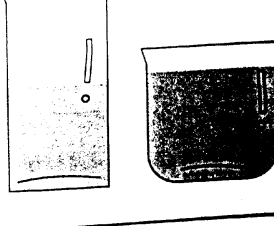
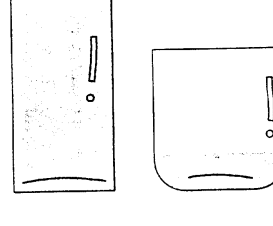
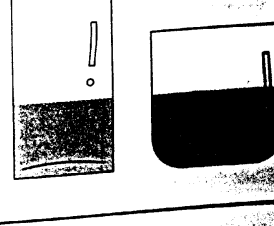
 <p>ก</p>	 <p>ข</p>
 <p>ค</p>	 <p>ง</p>

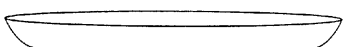
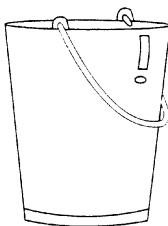
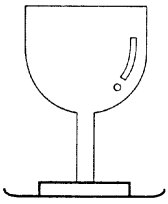
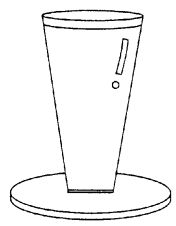

4 เหน้่าลงภาชนะใด ไม่ล้น

ก ข

ค ง

5 น้ำซ้อัด เท่ากับภาพแรก

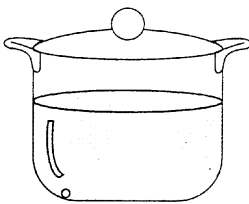
ก ข

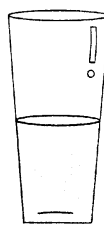
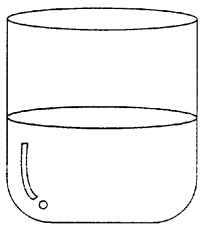
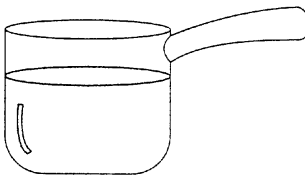
ค ง

6 นำน้ำในแก้วที่ 2 เทลงในแก้วที่มีขนาดเล็กกว่าระดับน้ำจะเป็นอย่างไร



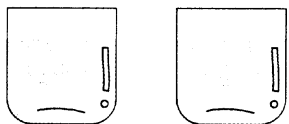
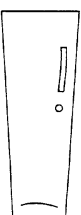
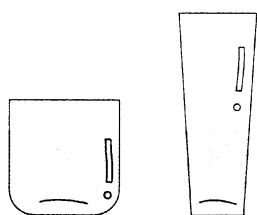
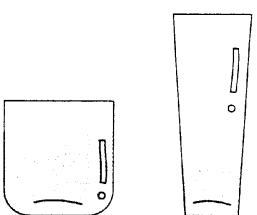
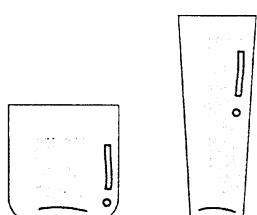
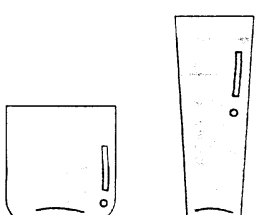



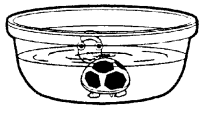
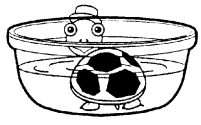
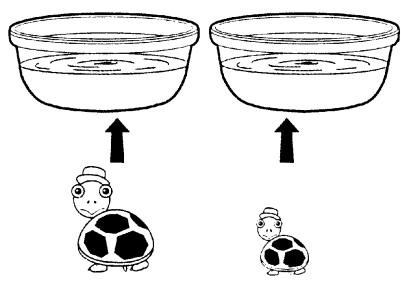

ก ข

ค ง

7

อ่างแก้ว 2 ใบ มีระดับน้ำ
เท่ากันน้ำเต่า 2 ตัวขนาดเล็ก
และใหญ่ ใส่ในอ่างแก้ว
อ่างละ 1 ตัว ระดับน้ำจะเป็น
อย่างไร



ก

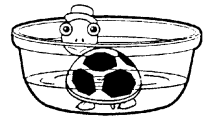
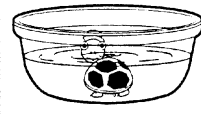

ข

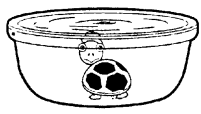
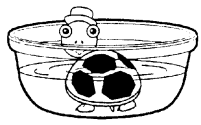

ค

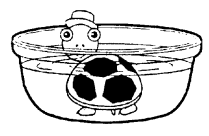
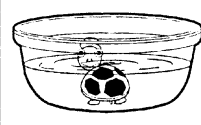

ง

8

อ่างน้ำมีน้ำอยู่ครึ่งอ่าง
ถ้าหมูลงไปนอนอบน้ำ
ในอ่างระดับน้ำจะเป็น
อย่างไร

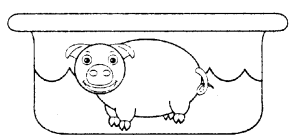
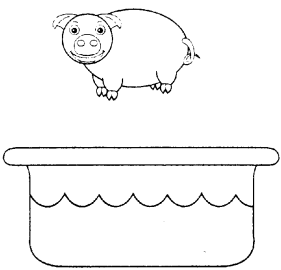

ก

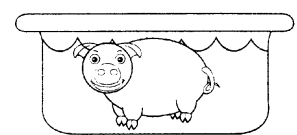

ข

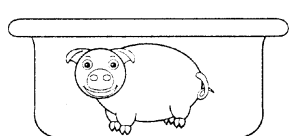

ค

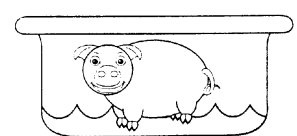

ง

9

ท่าเรือแห่งหนึ่งมีเรือบรรทุก
สินค้าจอดอยู่ท่าขนลงสินค้า
ใส่เรือจนเต็มลำ ระดับน้ำ
จะเป็นอย่างไร

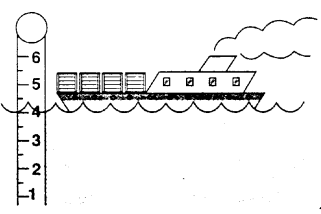
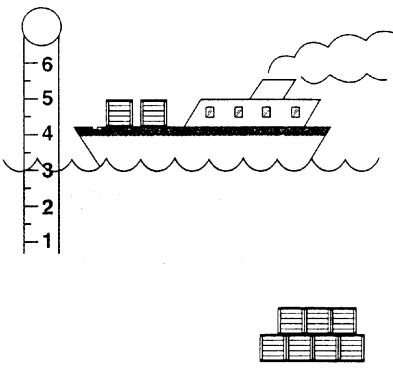

ก

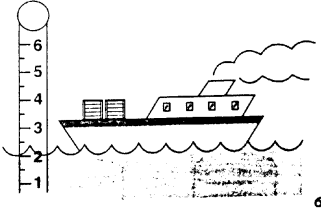

ข

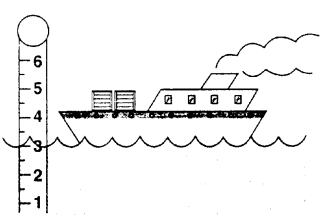

ค

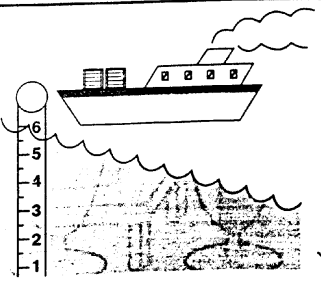

ง

10

นำน้ำในขัน 2 ใบ ซึ่งมีปริมาณ
เท่ากันใส่ในแก้ว 2 ใบที่มีขนาด
เท่ากันแต่ต่างกันตรงกัน คือใบ
หนึ่งก้นลึกกว่า ระดับน้ำในแก้ว
จะเป็นอย่างไร

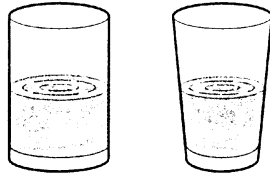
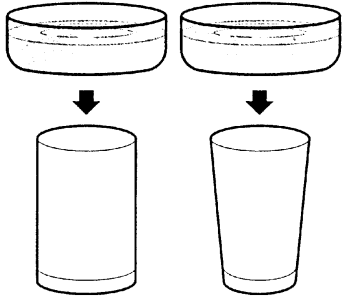

ก

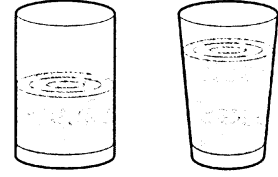

ข

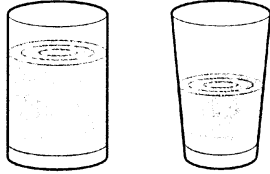

ค

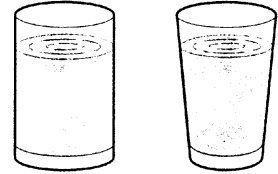

ง

11

อ่างอาบน้ำมีน้ำอยู่ครึ่งอ่าง
ถ้าเจ้าตุบจอมชน 2 ตัวนี้
ลงไปนอนอาบน้ำในอ่าง
ระดับน้ำจะเป็นอย่างไร

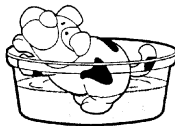
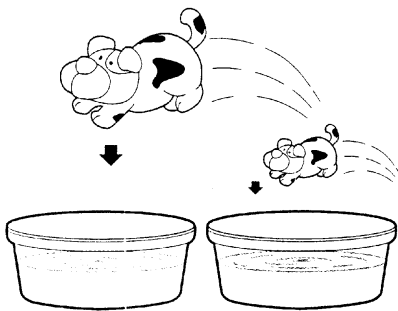

ก



ข



ค

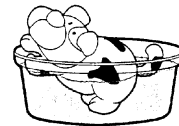

ง

12

นำน้ำในแก้ว 2 ใบที่มีขนาด
ต่างกันแต่มีปริมาณน้ำเท่ากัน
มาใส่ในแก้วที่มีขนาดและแบบ
เดียวกัน จะเป็นอย่างไร

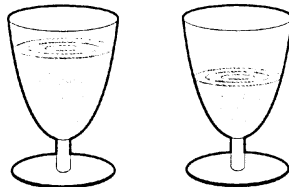
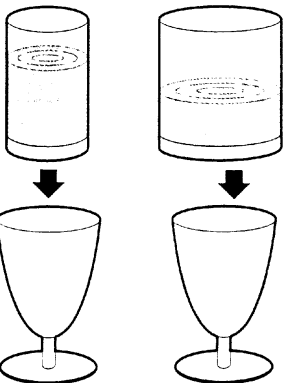

ก

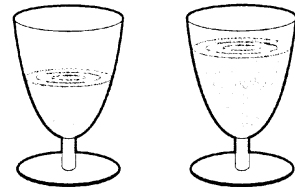

ข

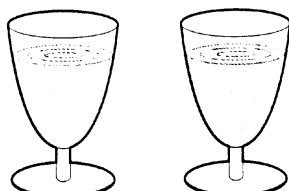

ค

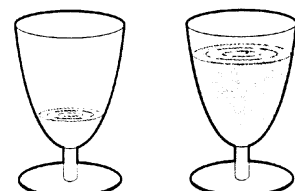

ง

13 ถ้าเอาน้ำจากขวดเหลงในหลอดแก้วรูปตัว U ระดับน้ำจะเป็นอย่างไร

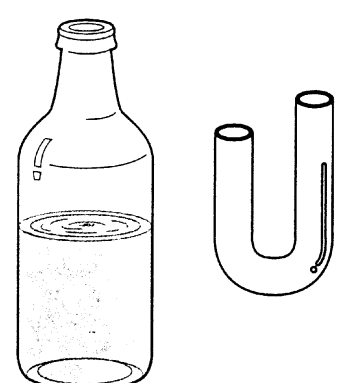

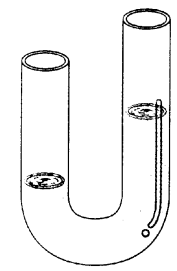
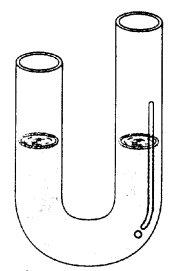
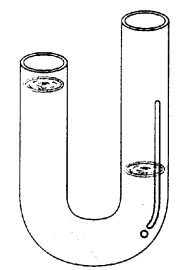
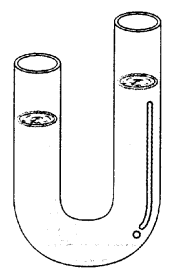
 ก	 ข
 ค	 ง

14 ถ้าเอาน้ำใส่กระป๋องที่เจาะรูไว้เรียงจากบนลงล่าง ขนาดรูเท่าๆ น้ำที่ไหลออกจากรูจะมีลักษณะอย่างไร

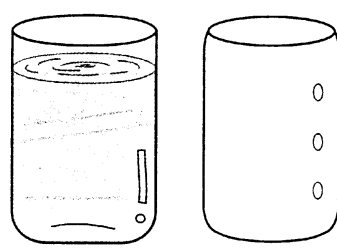

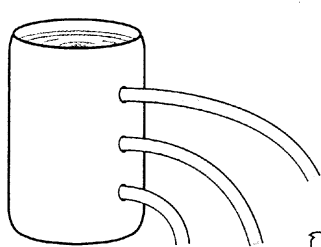
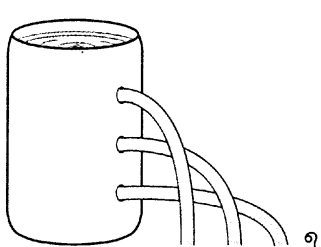
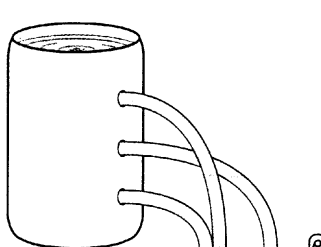
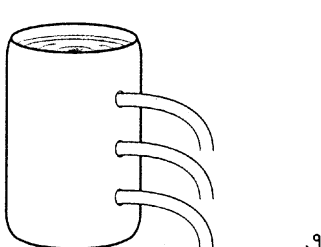
 ก	 ข
 ค	 ง

15 ถ้าต้องการจะถ่ายน้ำจากถังลงใส่ขวดโหลโดยใช้สายยาง ต้องวางถังและขวดโหลในลักษณะใดจึงถ่ายได้สะดวกที่สุด

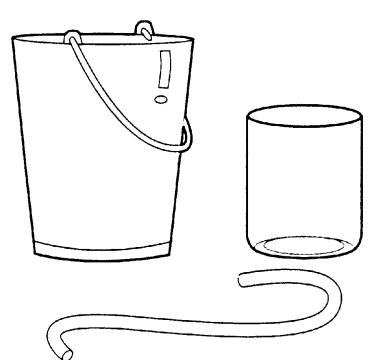

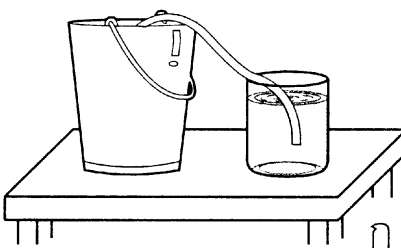
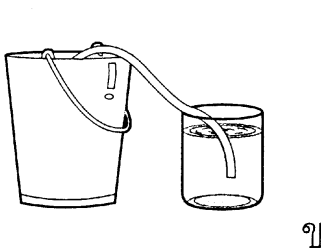
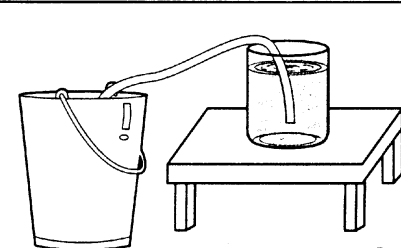
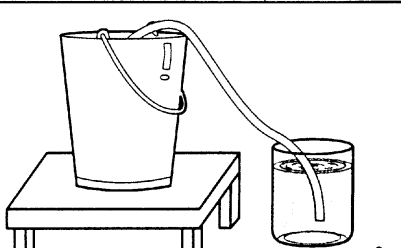
 ก	 ข
 ค	 ง

✔ จงขีด ✓ ข้อที่มีน้ำหนักสัมพันธ์กับภาพในช่องแรก

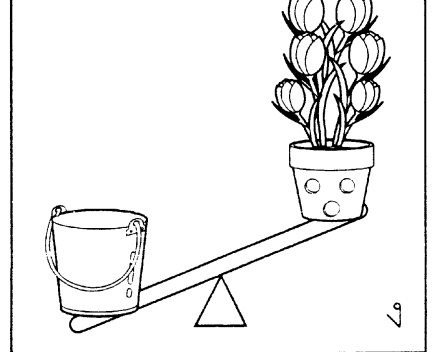
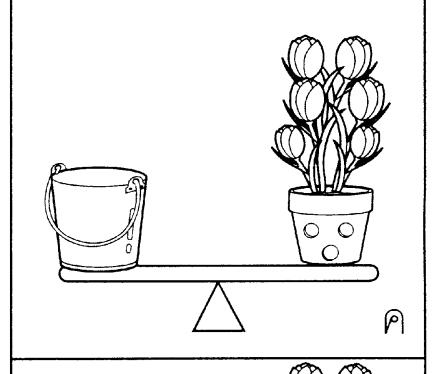
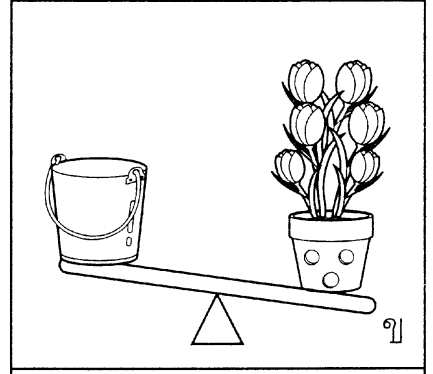
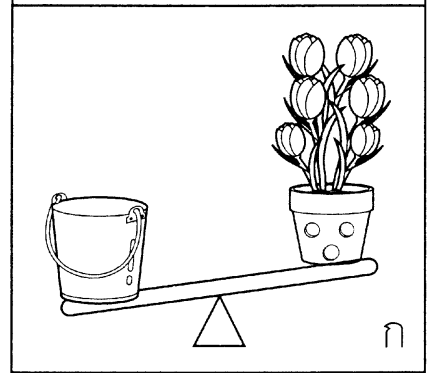
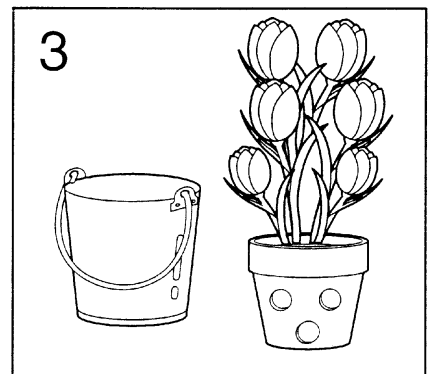
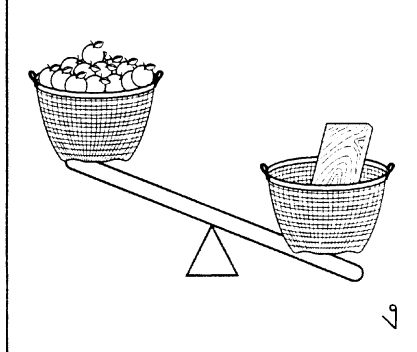
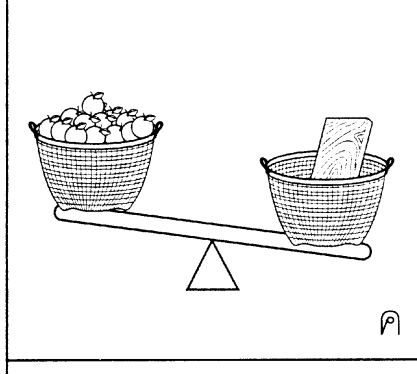
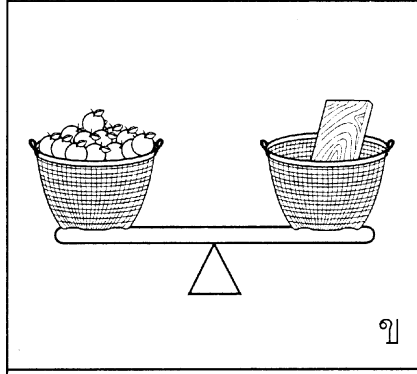
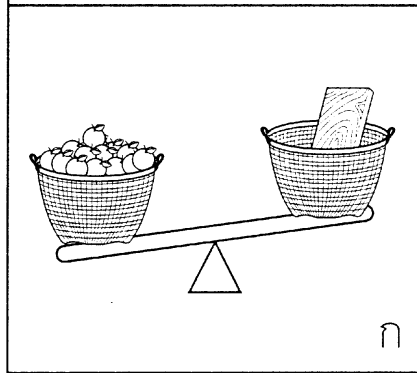
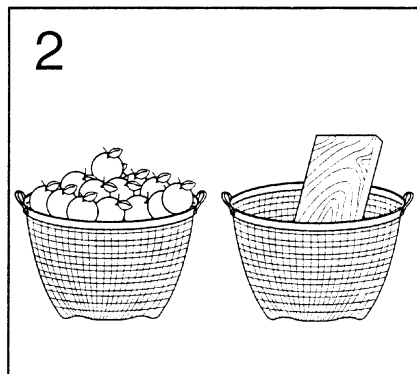
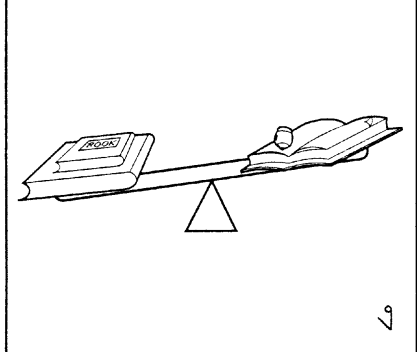
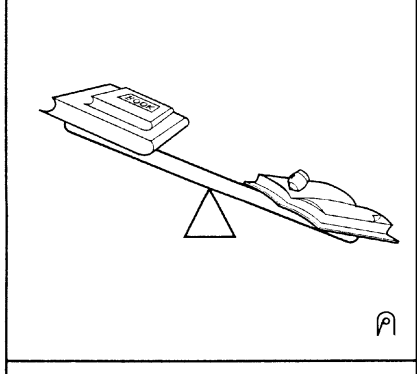
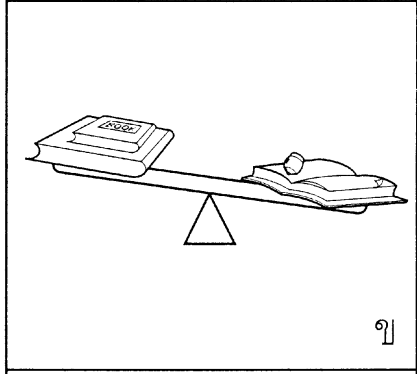
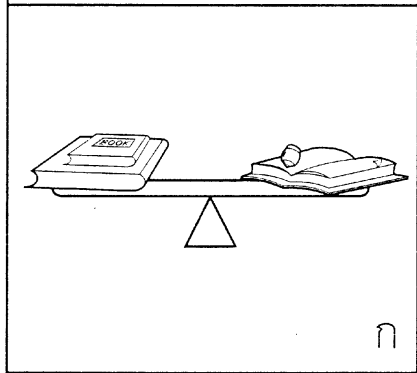
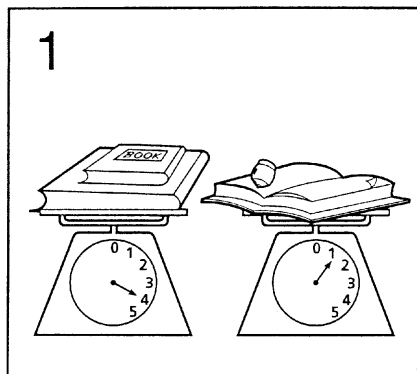

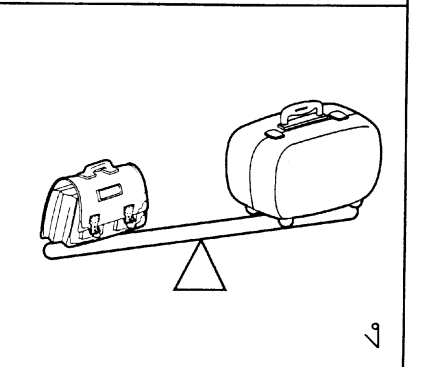
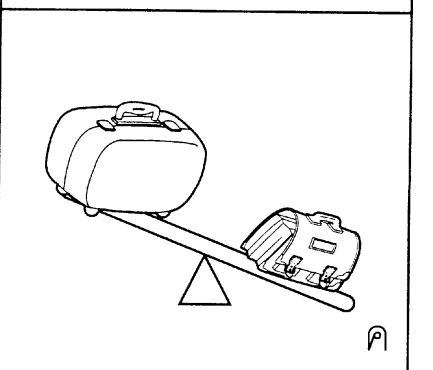
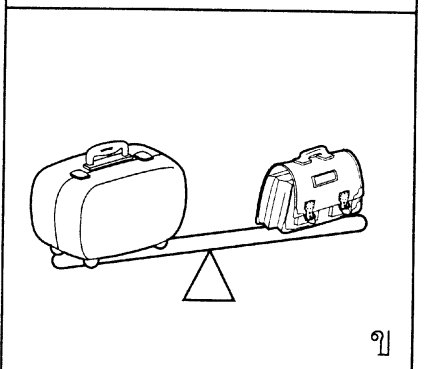
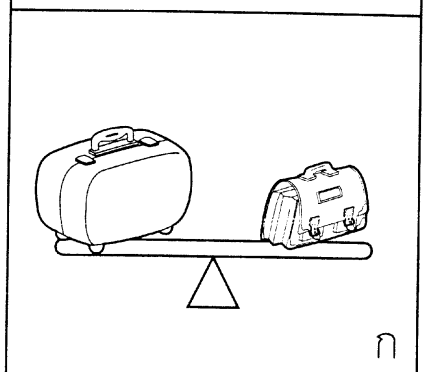
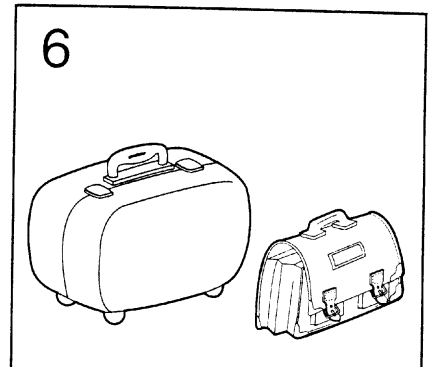
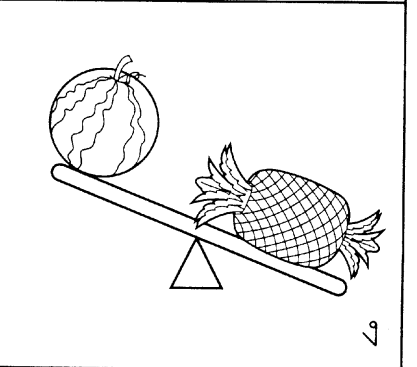
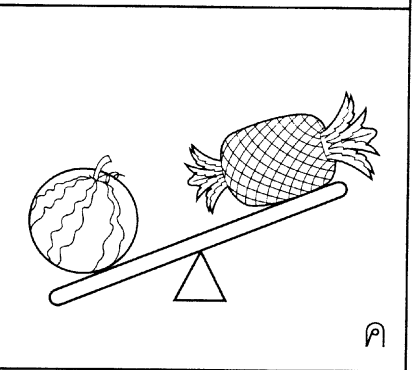
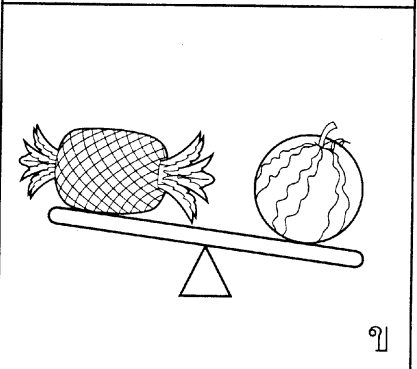
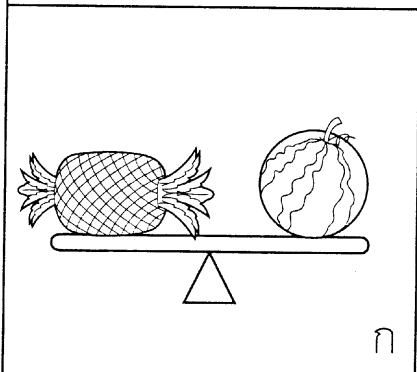
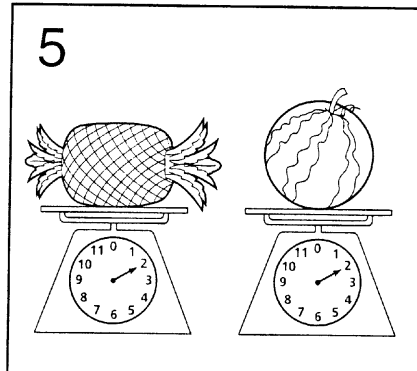
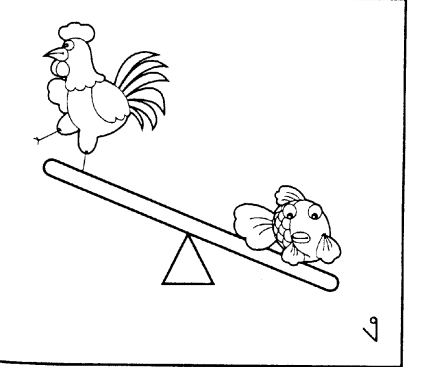
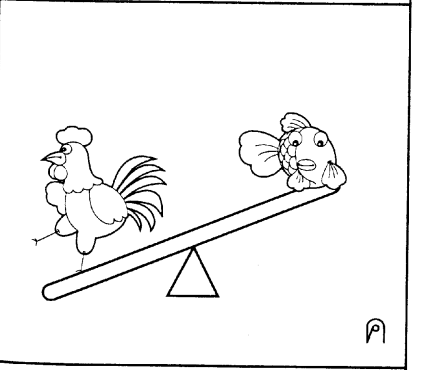
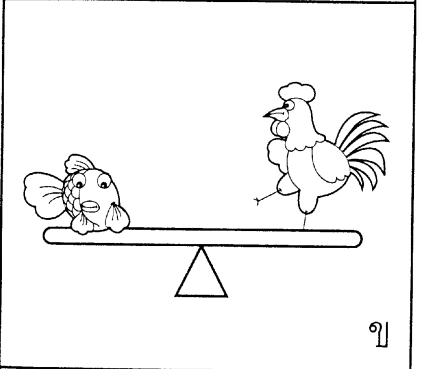
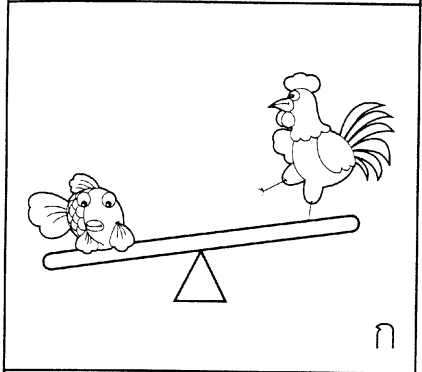
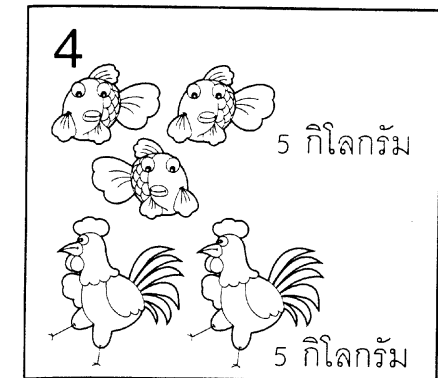

7

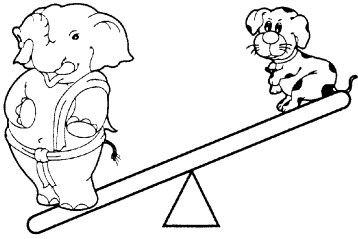

90 Kg



90 Kg



10 Kg



80 Kg



60 Kg

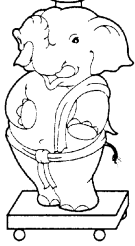

60 Kg



90 Kg



10 Kg



8

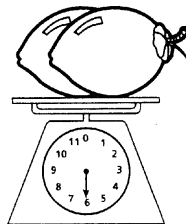
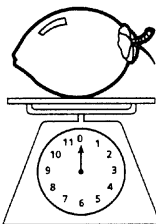
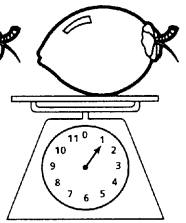
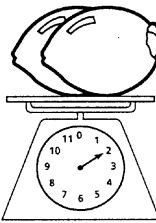
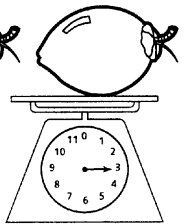
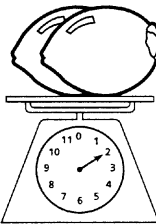
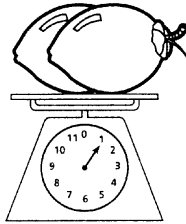
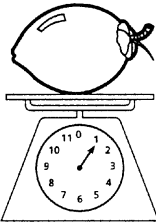
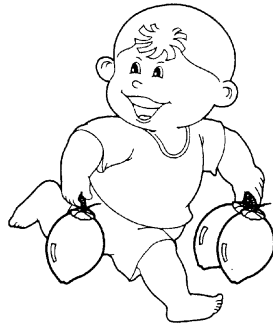

9

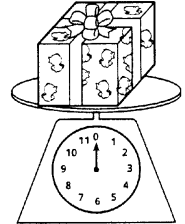
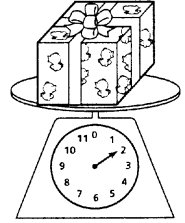
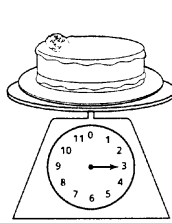
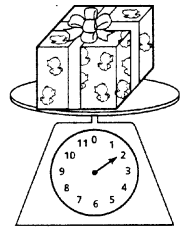
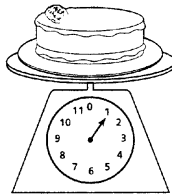
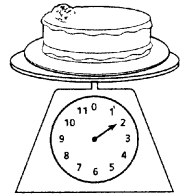
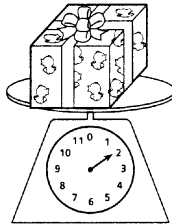
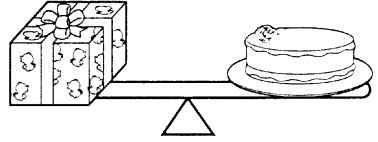

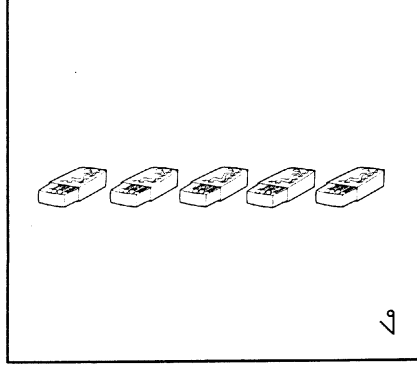
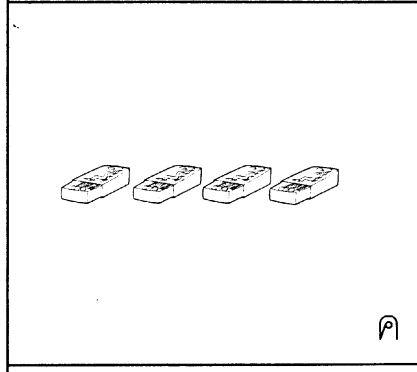
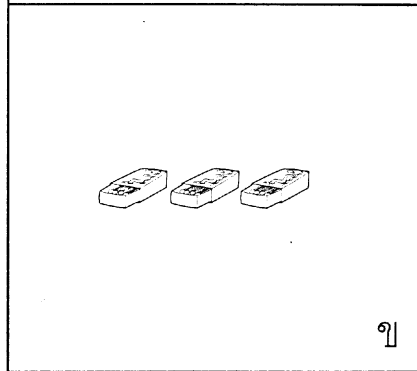
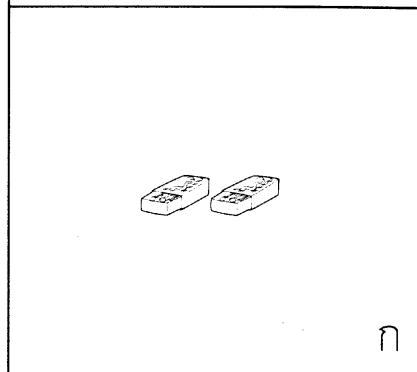
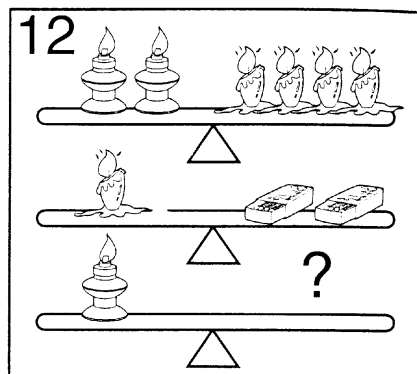
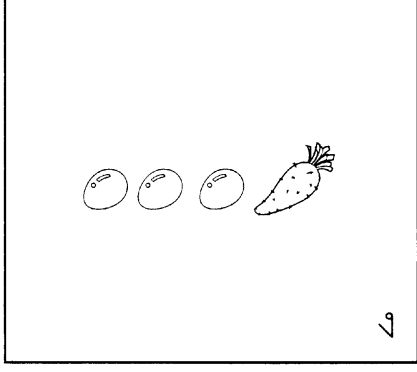
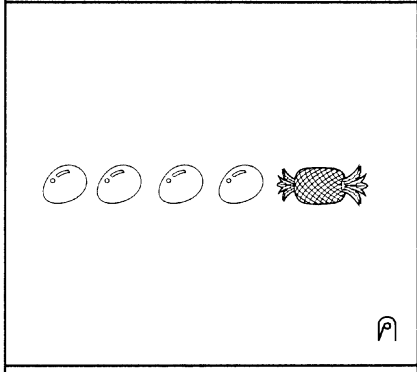
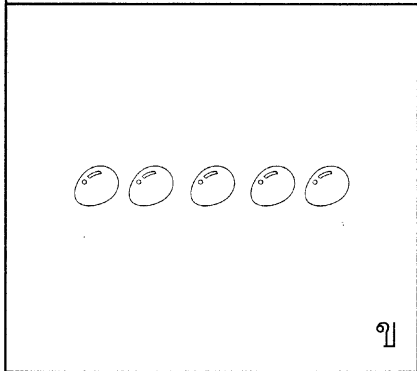
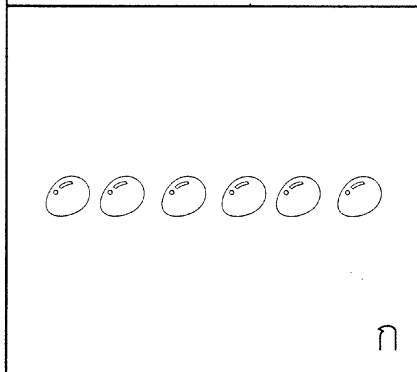
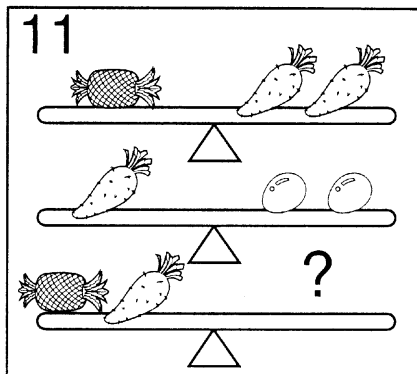
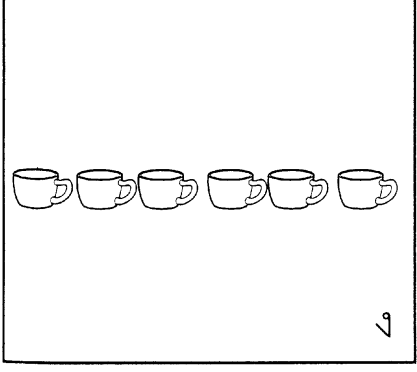
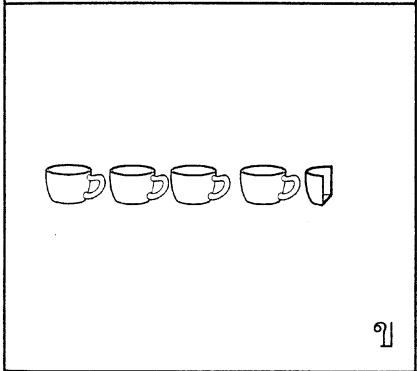
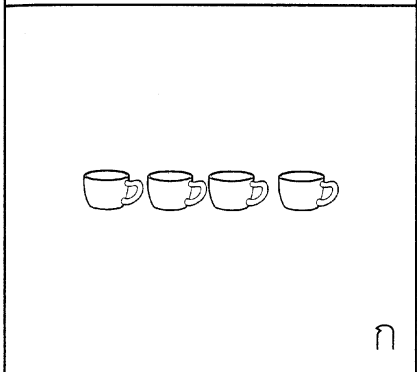
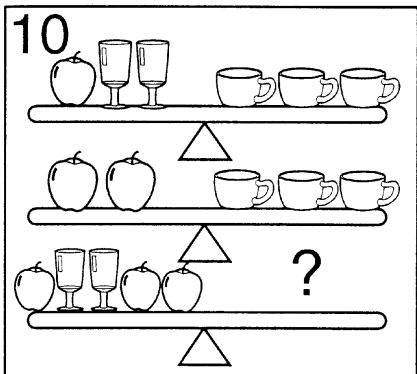

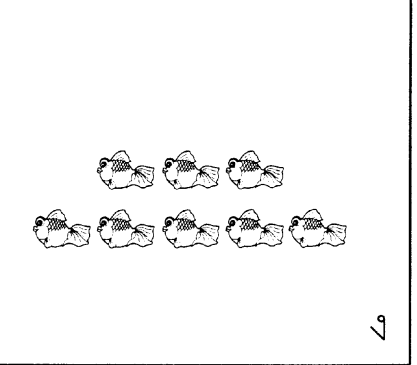
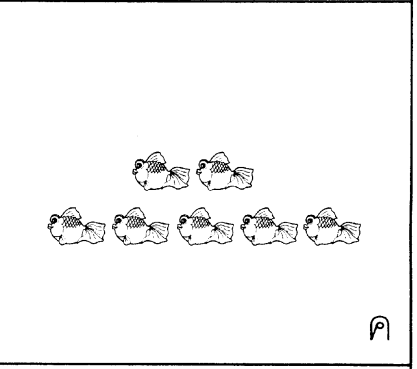
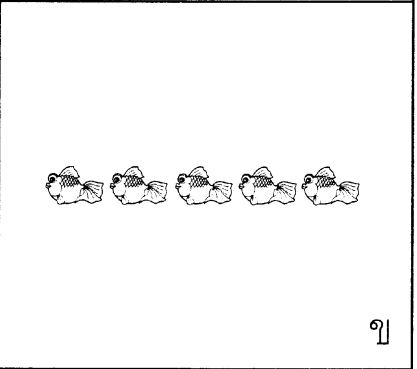
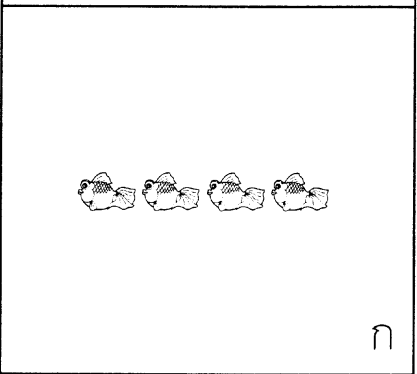
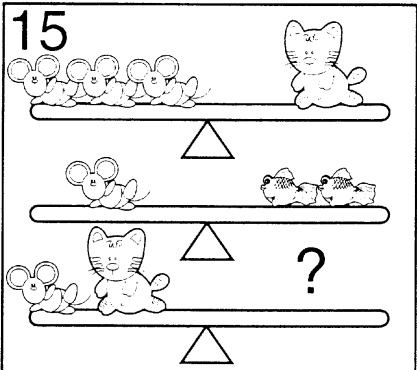
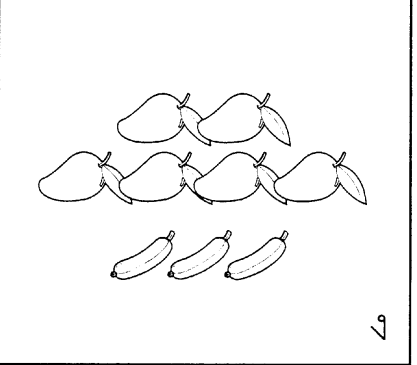
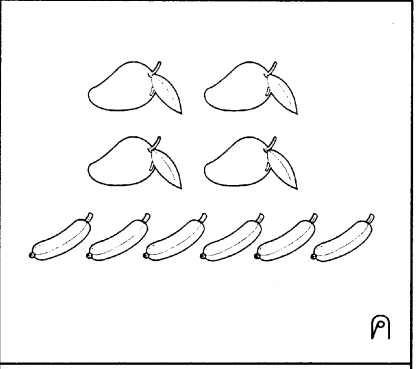
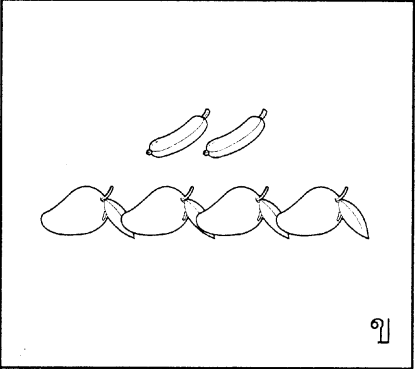
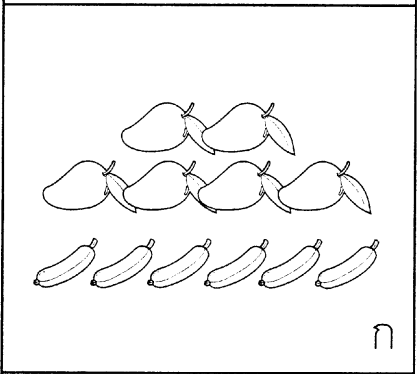
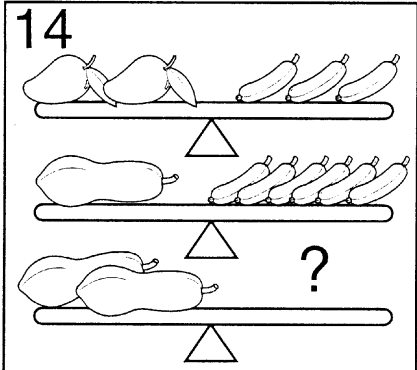
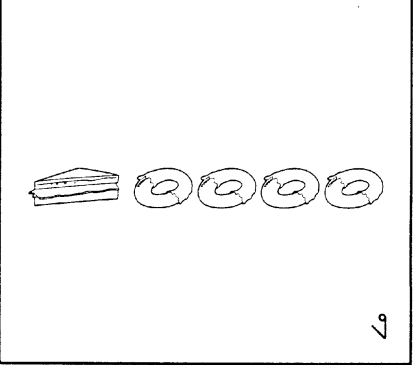
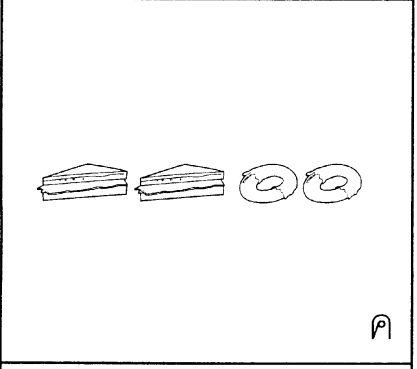
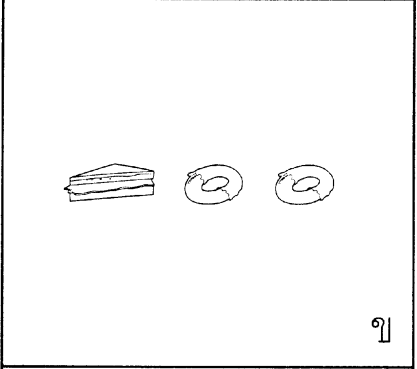
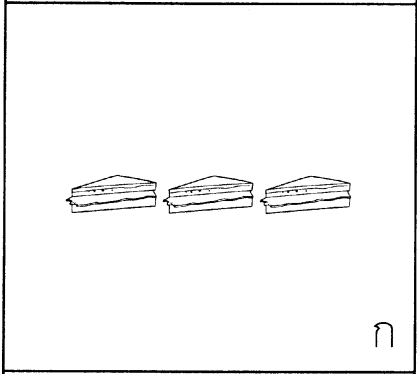
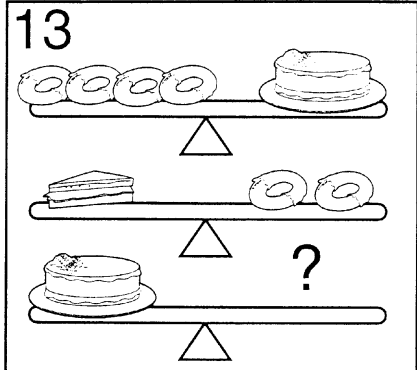

จงขีด ✓ ข้อที่มีระยะทางยาวเท่ากับภาพในช่องแรก

1 เด็กคนโตที่ขี่จักรยานได้ระยะทางเท่ากับเด็กในภาพแรก

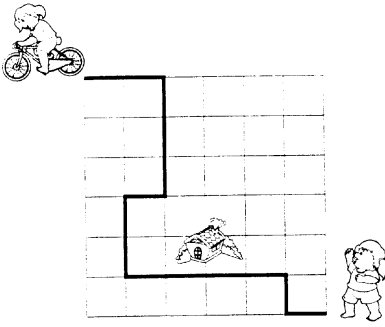
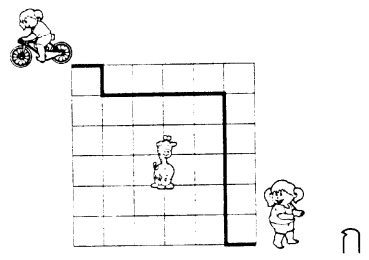
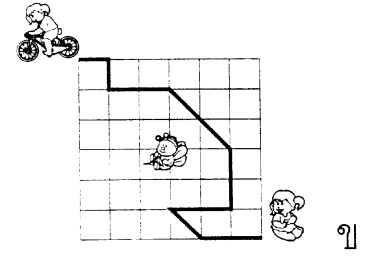
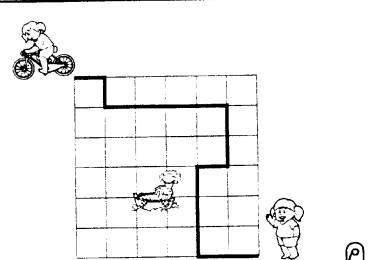
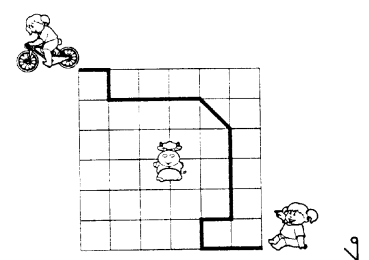
2 เด็กในภาพใดเดินได้ระยะทางยาวเท่ากับเด็กในภาพแรก

3 แมลงในภาพใดบินได้ระยะทางยาวเท่ากับภาพแรก

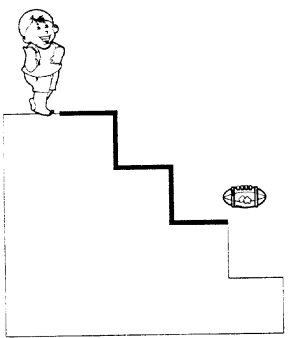
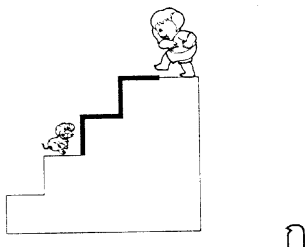
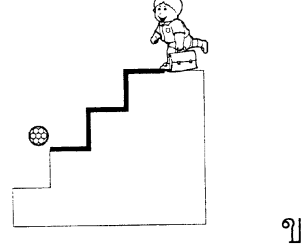
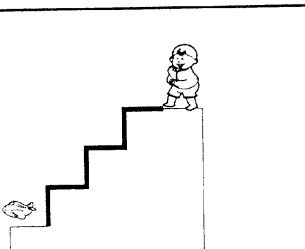
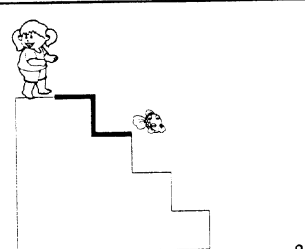
4 คณงานในภาพโตทาสีราว สะพานได้ความยาวเท่ากับ ภาพแรก

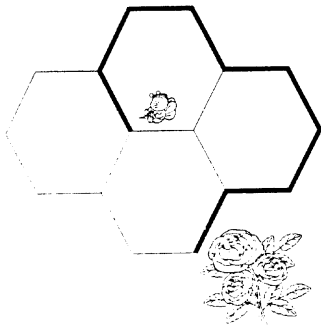
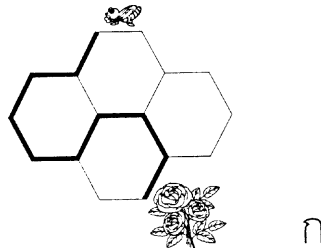
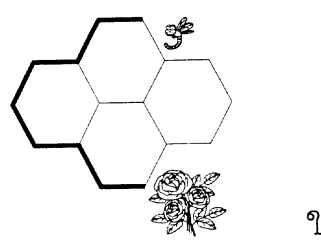
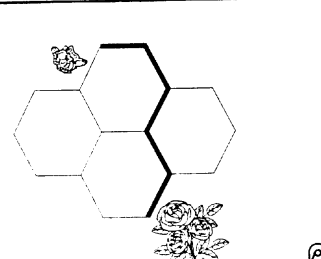
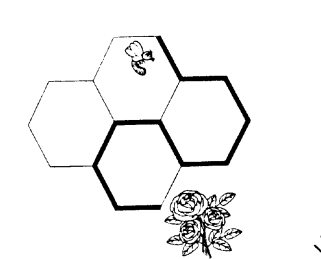

ก

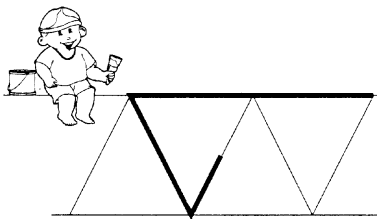
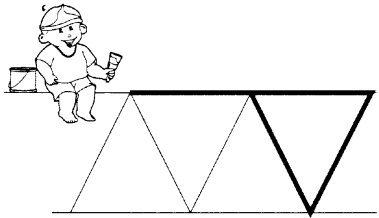

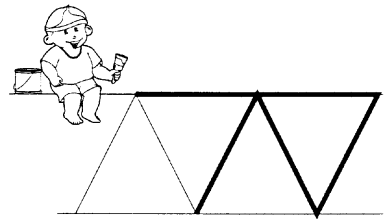
ข

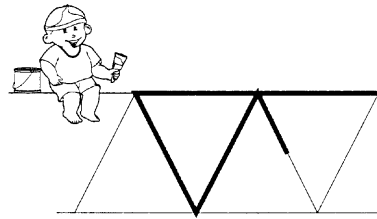

ค

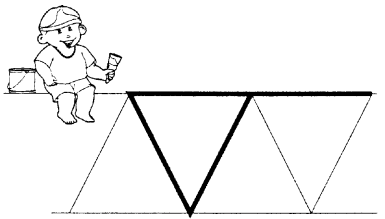

ง

5 คณงานกำลังเลื่อยไม้เป็น 4 ชิ้น ไม้ที่เลื่อยแล้วต่อได้ มีความยาวเท่ากับไม้ ในภาพแรก

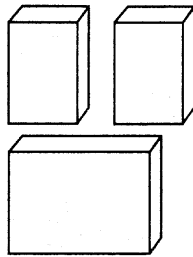
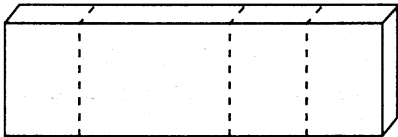
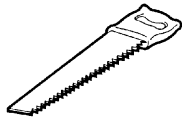

ก

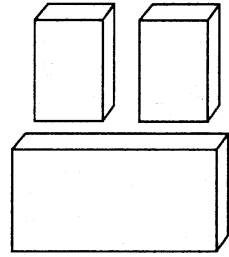

ข

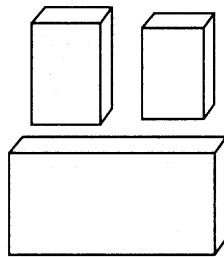

ค

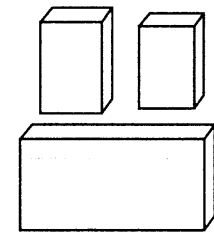

ง

6 ให้หาผ้าที่มีความยาว เพียงพอที่จะทำม่าน ใ้หน้าต่าง 3 บานนี้

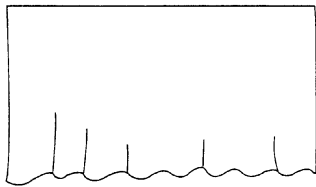
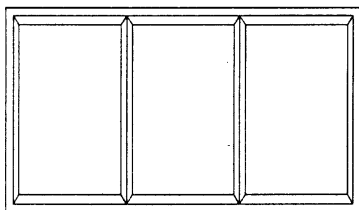

ก

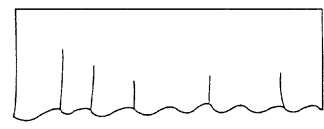

ข

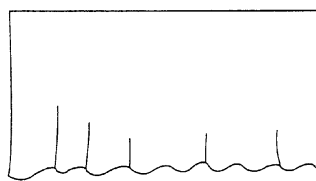

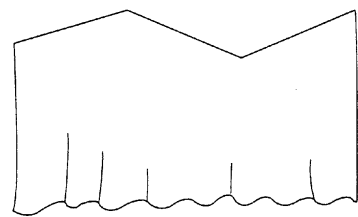

ค

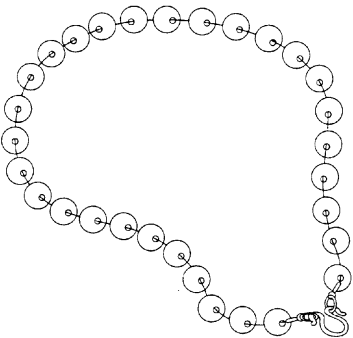

ง

7 สร้อยเส้นใดมีความยาว
รวมแล้วเท่ากับสร้อย
ในภาพแรก

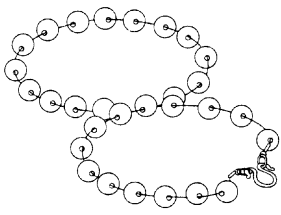
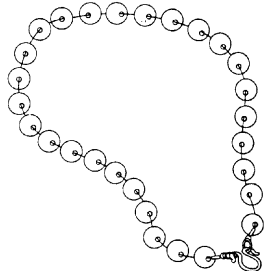

 <p>ก</p>	 <p>ข</p>
 <p>ค</p>	 <p>ง</p>

8 เชือกเส้นใดมีความยาว
พอที่จะนำมาขดทับ
ภาพแรกได้พอดี

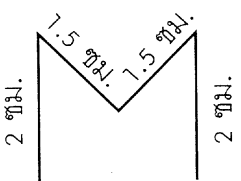

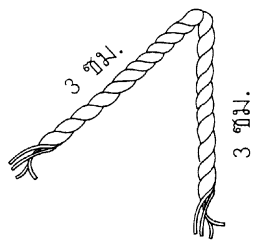
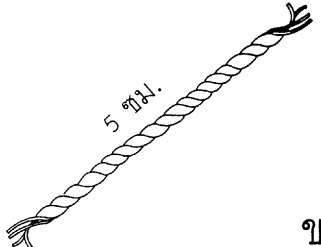
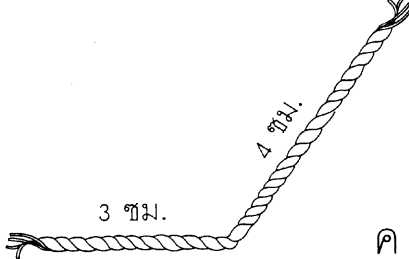
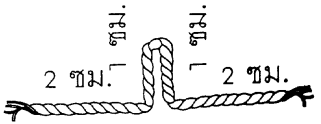
 <p>ก</p>	 <p>ข</p>
 <p>ค</p>	 <p>ง</p>

9 กล่องใบใดที่มีความยาวพอ
ที่จะใส่ขนมปังแถวนี้ได้

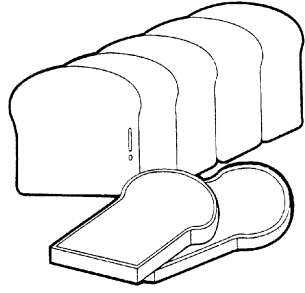

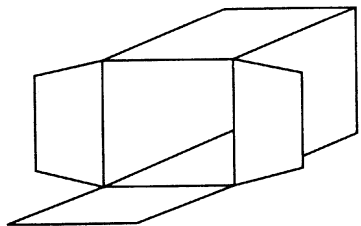
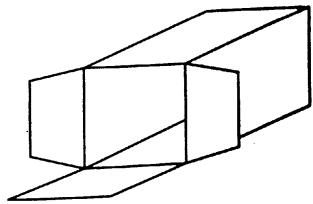
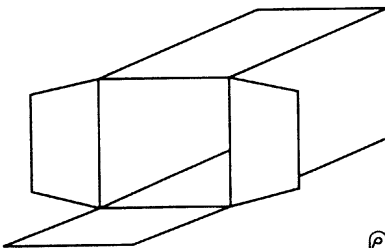
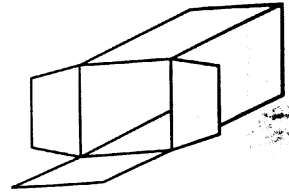
 <p>ก</p>	 <p>ข</p>
 <p>ค</p>	 <p>ง</p>

10 ดินสอในภาพใดที่นำมา
ต่อกันแล้วมีความยาว
เท่ากับดินสอในภาพแรก

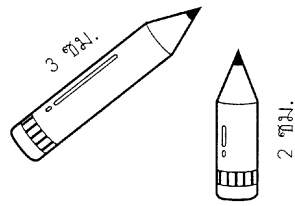
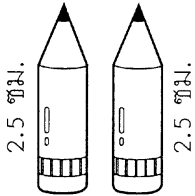

ก

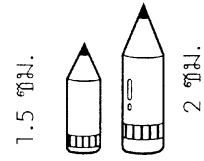

ข

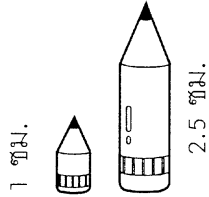

ค

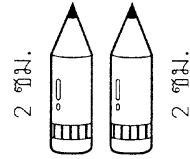

ง

11 ใครที่วิ่งได้ระยะทางเท่ากับ

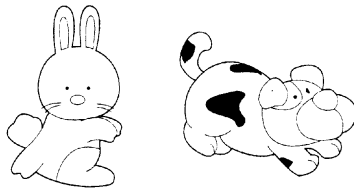
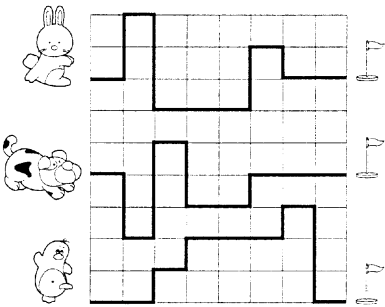

ก

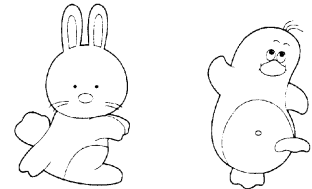

ข

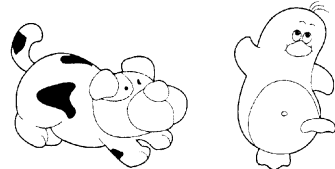

ค

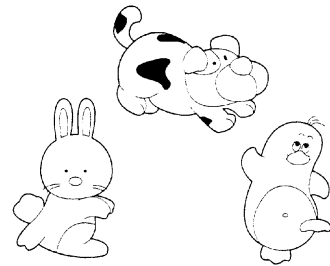

ง

12 ภาพใดพายเรือได้ระยะทาง
เท่ากับภาพแรก

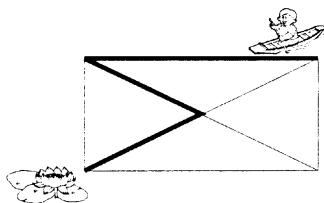
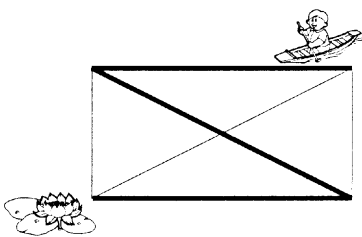

ก

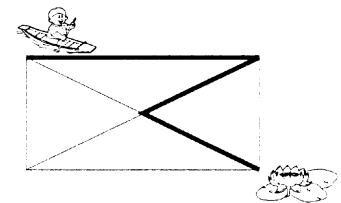

ข

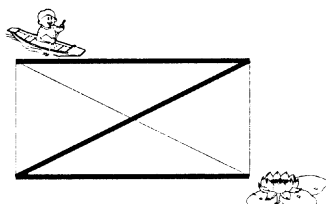

ค

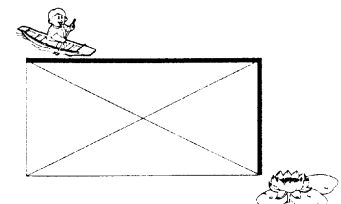

ง

13 กบตัวใดกระโดดขึ้นเนิน
ได้ระยะทางเท่ากับกบ
ในภาพแรก

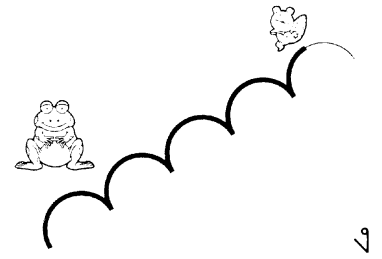
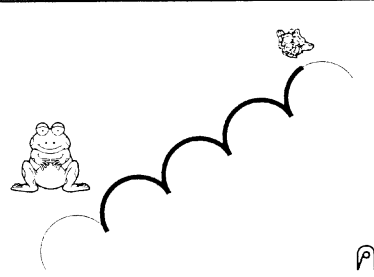
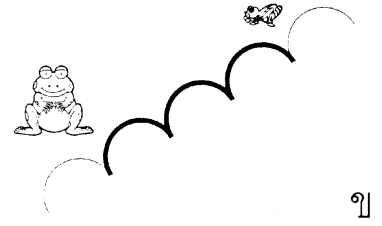
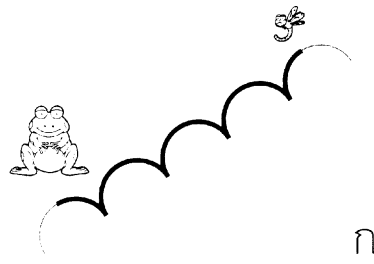
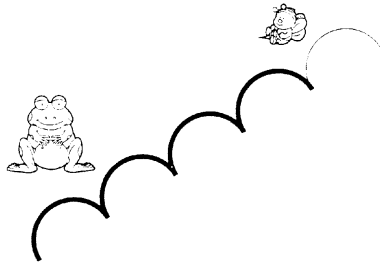

14 เครื่องบินในภาพใดบินได้
ระยะทางยาวเท่ากับ
เครื่องบินในภาพแรก

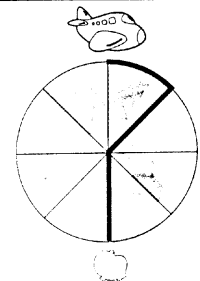
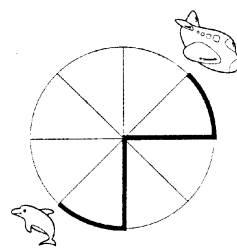
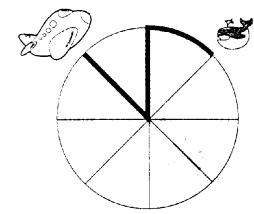
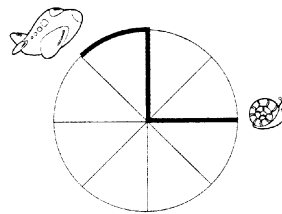
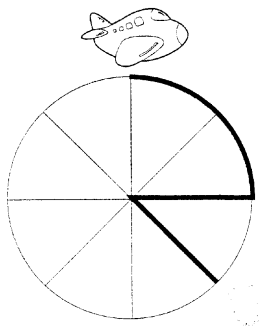

15 ที่คั่นหนังสือในภาพใด
เมื่อนำมาต่อกันแล้วจะมี
ความยาวเท่ากับภาพแรก

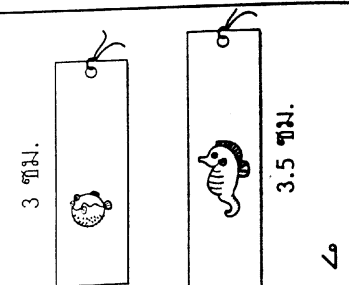
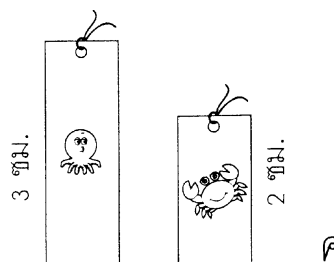
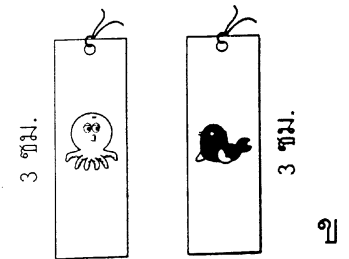
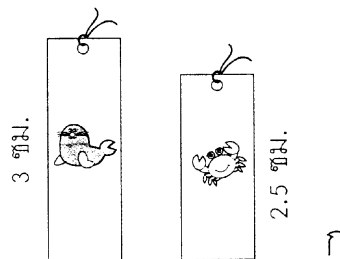
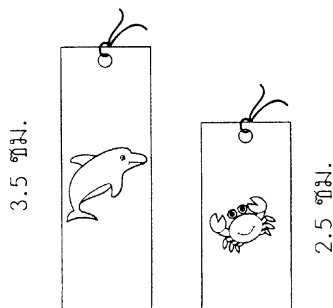

จุดขีด ✓ ข้อที่นาฬิกา บอกเวลาตามภาพที่กำหนดในช่องแรก

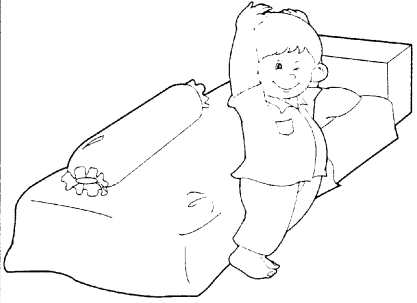
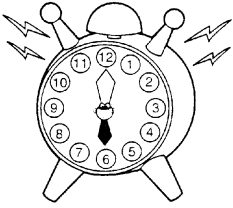
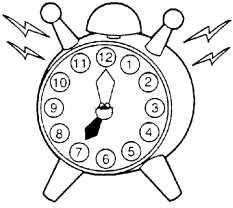
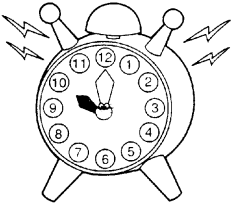
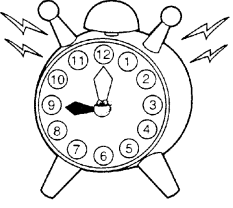
<p>1 เราควรวินนอนเวลาใด</p> 	 <p>ก</p>	 <p>ข</p>
 <p>ค</p>	 <p>ง</p>	

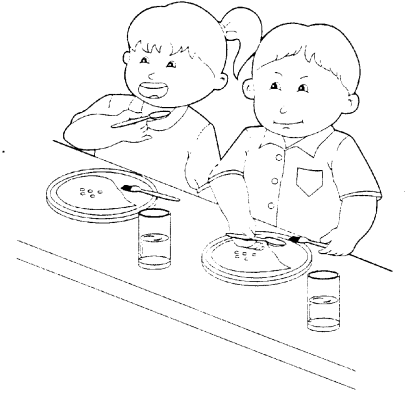
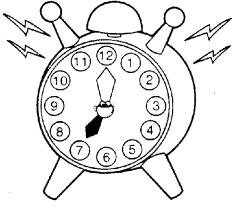
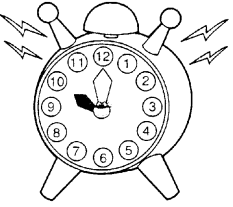
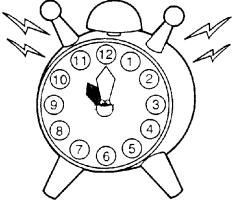
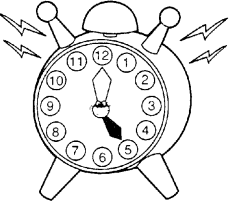
<p>2 นักเรียนรับประทานอาหารเช้าที่โรงเรียนเวลาใด</p> 	 <p>ก</p>	 <p>ข</p>
 <p>ค</p>	 <p>ง</p>	

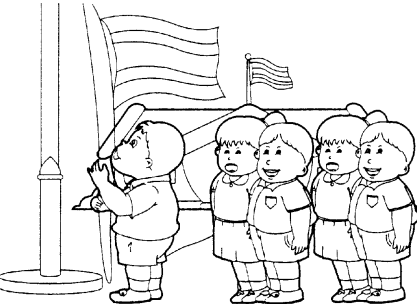
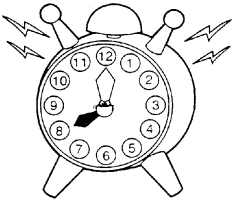
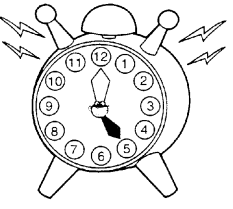
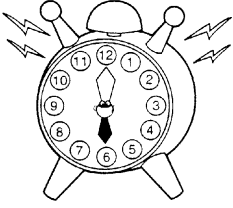
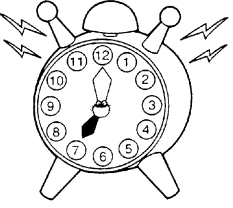
<p>3 นักเรียนเคารพธงชาติตอนเช้าเวลาใด</p> 	 <p>ก</p>	 <p>ข</p>
 <p>ค</p>	 <p>ง</p>	

4 นักเรียนนอนกลางวัน
ที่โรงเรียนในเวลาใด

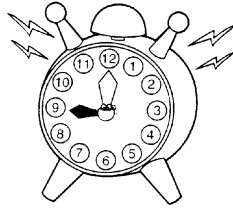

ก

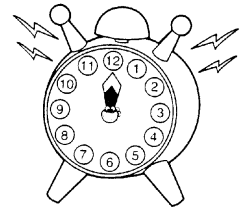

ข

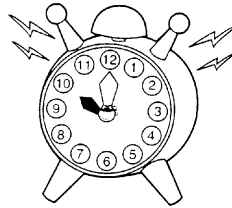

ค

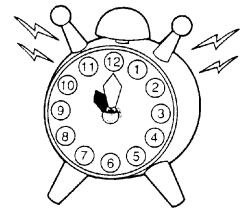

ง

5 นักเรียนรับประทาน
อาหารเข้าเวลาใด

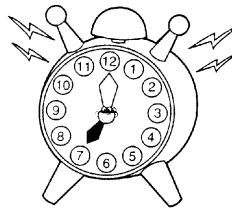

ก

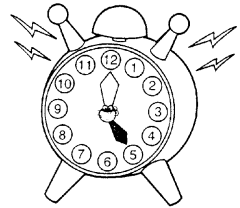

ข

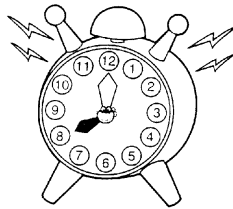

ค

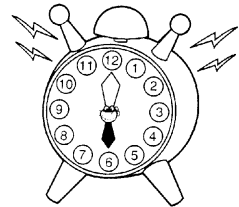

ง

6 นักเรียนเข้านอนเวลาใด

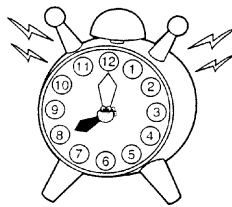

ก

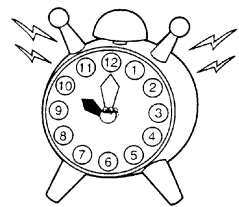

ข

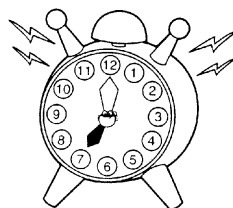

ค

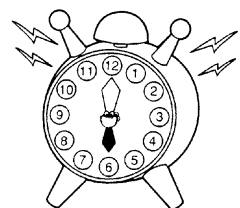

ง

7 นักเรียนดื่มนมที่โรงเรียน
เวลาใด

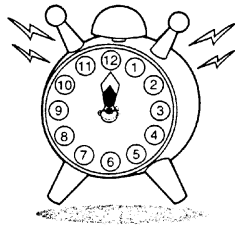

ก

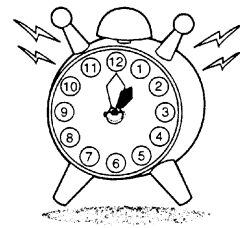

ข

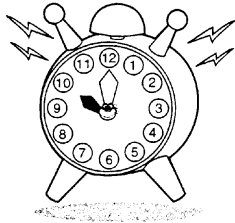

ค

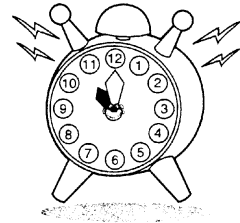

ง

8 เราเชิญธงชาติลงจากเสา
ในตอนเย็นเวลาใด

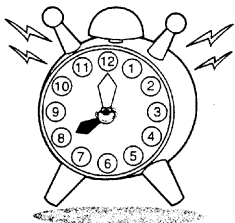
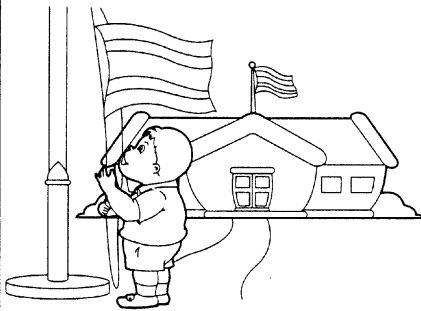

ก

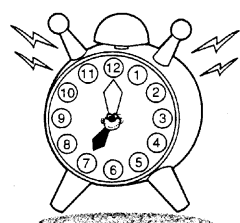

ข

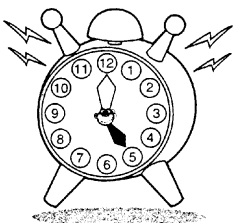

ค

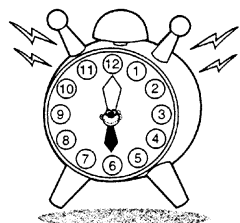

ง

9 นักเรียนทำการบ้าน
ตอนเย็นเวลาใด

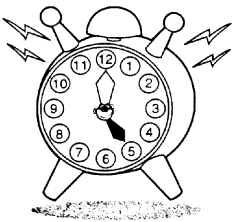

ก

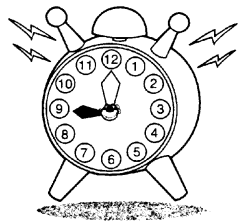

ข

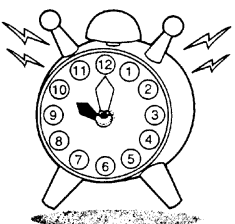

ค

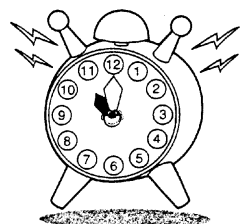

ง

10 เวลาใดที่นักเรียนไปโรงเรียนสาย

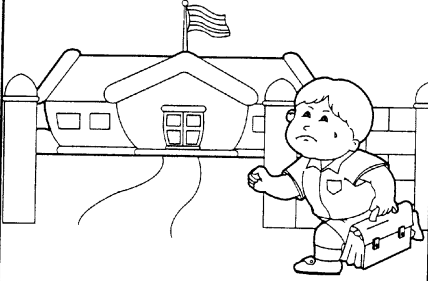

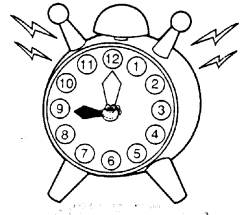
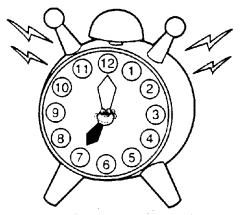
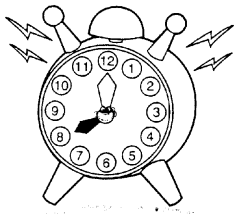
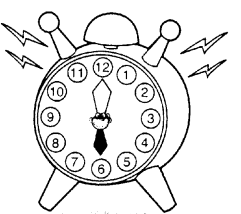
	ก		ข
	ค		ง

11 โรงเรียนเข้าเวลาใด

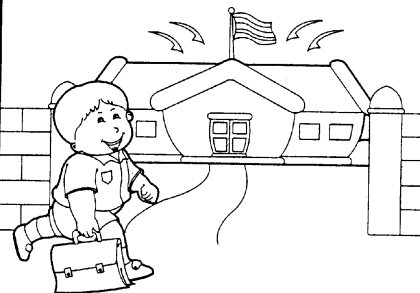

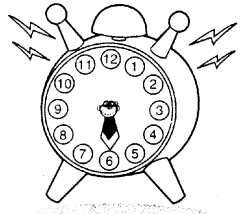
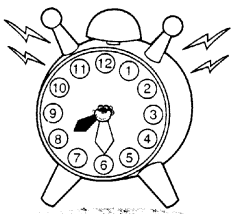
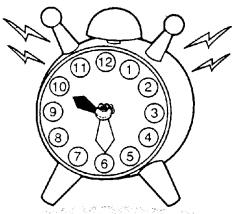
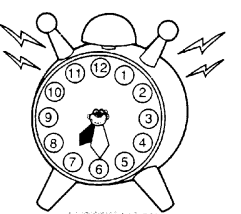
	ก		ข
	ค		ง

12 โรงเรียนเลิกเวลาใด

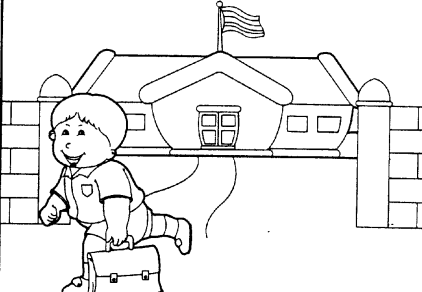

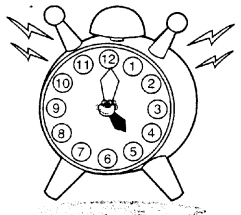
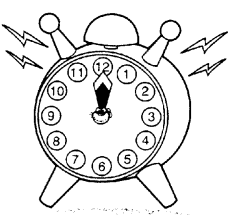
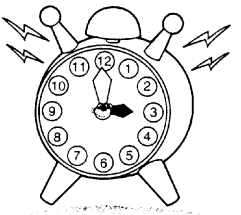
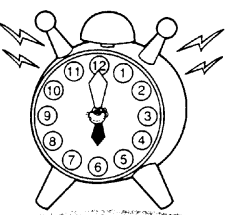
	ก		ข
	ค		ง

จงขีด ✓ ข้อที่มีพื้นที่ว่างเท่ากับภาพแรก

1 พื้นที่ว่างในชั้นวางรองเท้าได้เท่ากับภาพแรก

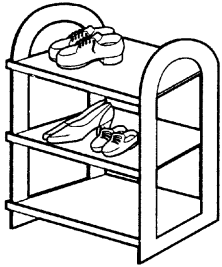

ก

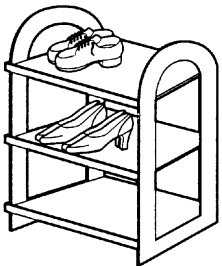

ข

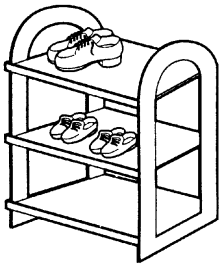

ค

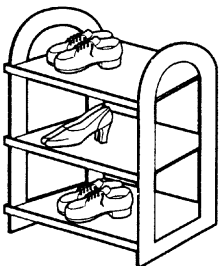

ง

2 พื้นที่ว่างในลังใส่ของได้เท่ากับภาพแรก

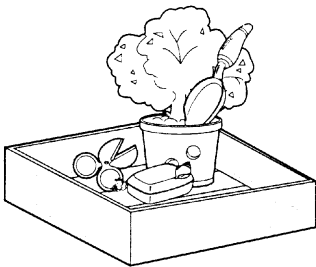
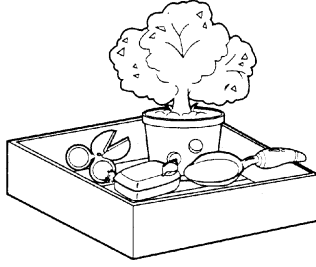

ก

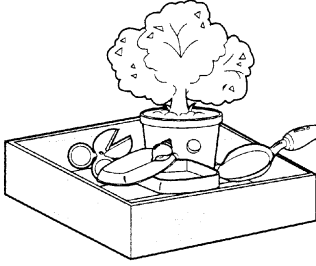

ข

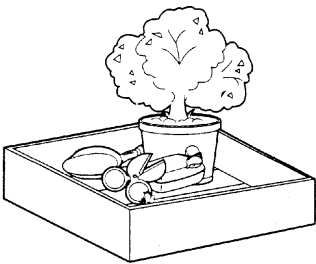

ค

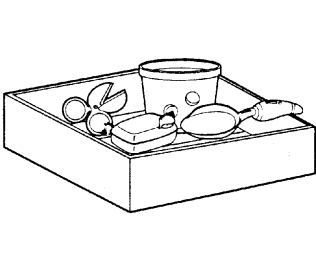

ง

3 พื้นที่ว่างในถาดใบโตเท่ากับภาพแรก



ก

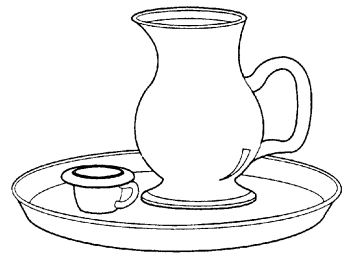

ข



ค



ง

4 พื้นที่ว่างบนเสื่อผืนใด
ที่เท่ากับภาพแรก

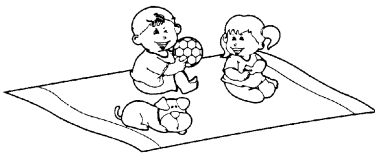
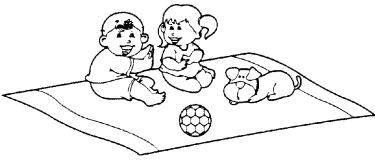

ก



ข



ค



ง

5 พื้นที่ว่างในตู้ใส่เครื่องเขียน
ใดที่เท่ากับภาพแรก

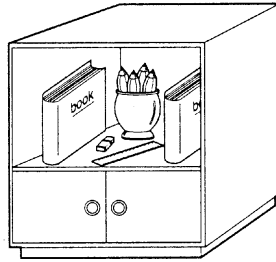
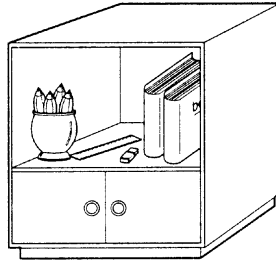

ก

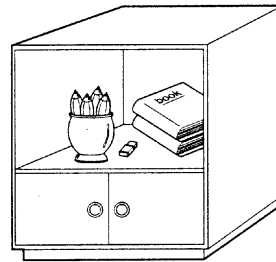

ข

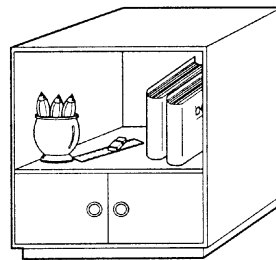

ค

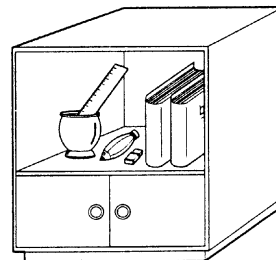

ง

6 พื้นที่ว่างในตู้เสื้อผ้าใด
เท่ากับภาพแรก

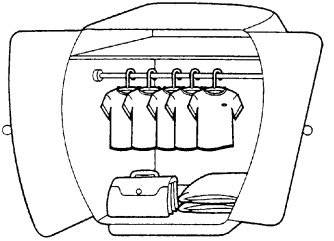
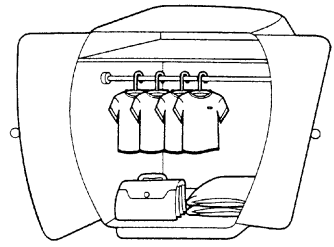

ก

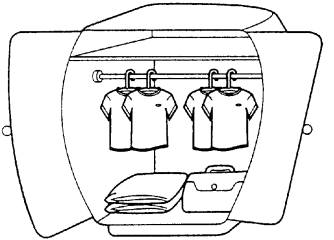

ข

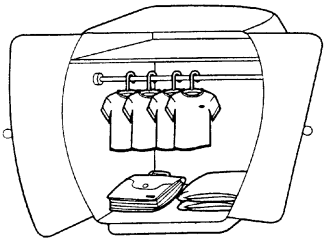

ค

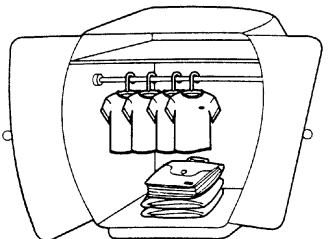

ง

7 ภาพใดที่มีพื้นที่ที่ยังไม่ได้ระบายสีเท่ากับภาพแรก

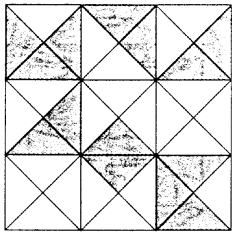
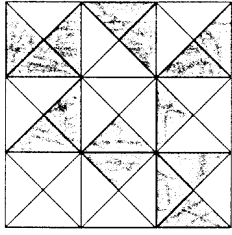

ก

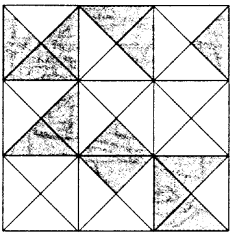

ข

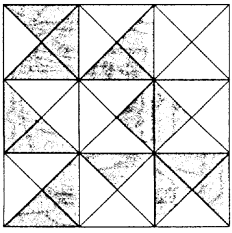

ค

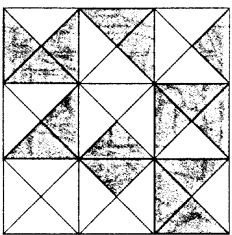

ง

8 พื้นที่วางบนโต๊ะภาพใดเท่ากับภาพแรก

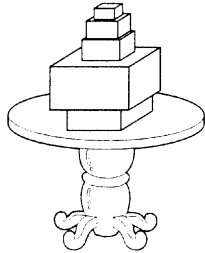
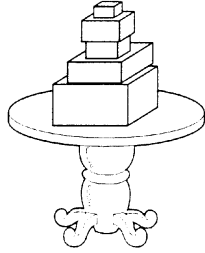

ก

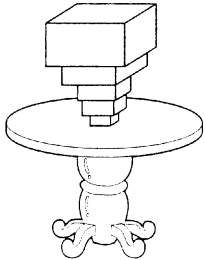

ข

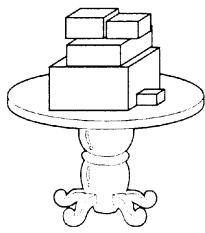

ค

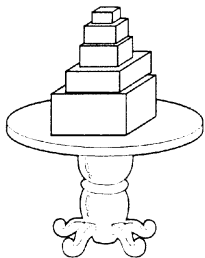

ง

9 พื้นที่ที่ยังไม่ได้ระบายสีภาพใดที่เท่ากับภาพแรก

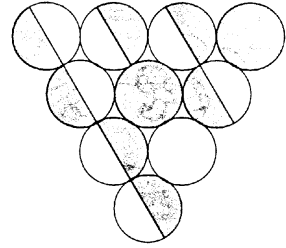
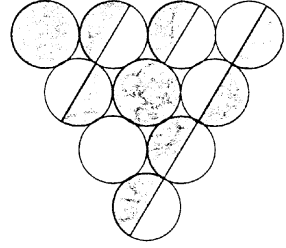

ก

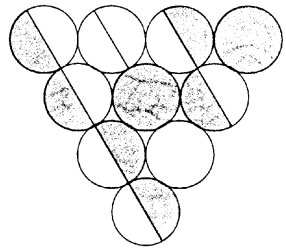

ข

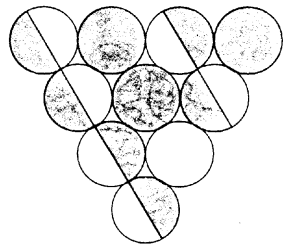

ค

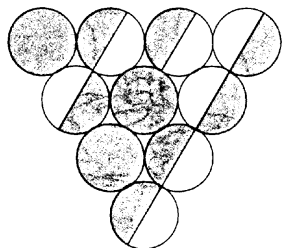

ง

10 ภาพใดที่มีพื้นที่ว่าง
บนม้านั่งที่เท่ากับภาพแรก

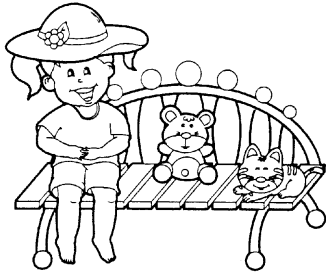
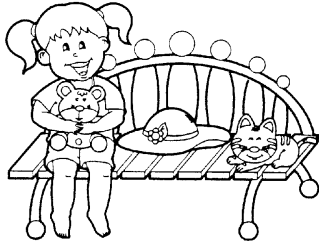

ก

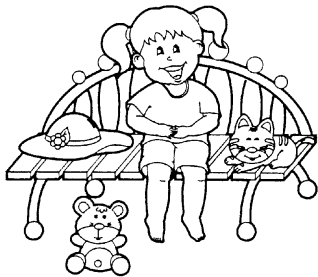

ข

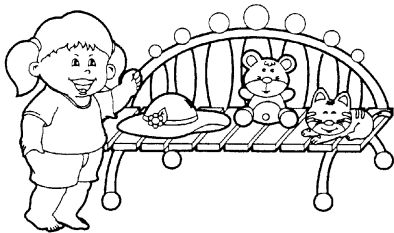

ค

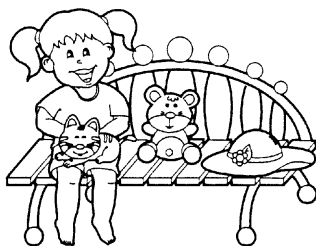

ง

11 ภาพใดที่มีพื้นที่ว่าง
บนรถเข็นที่เท่ากับภาพแรก

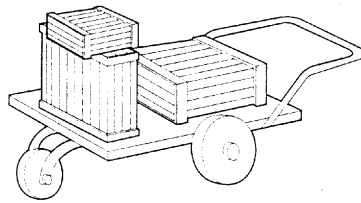
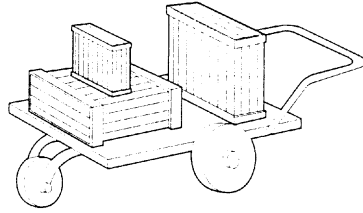

ก

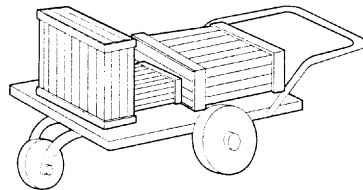

ข

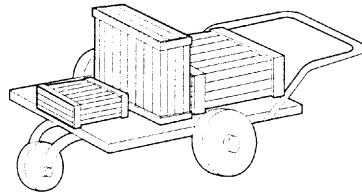

ค

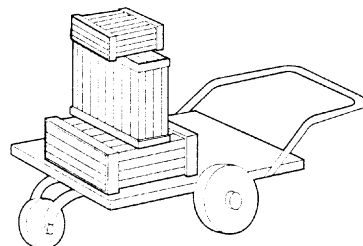

ง

12 พื้นที่ว่างบนเตียงใด
ที่เท่ากับภาพแรก

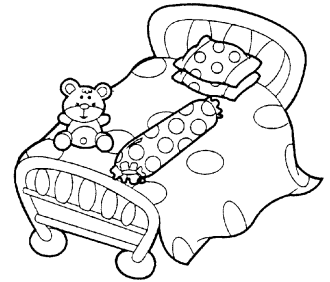
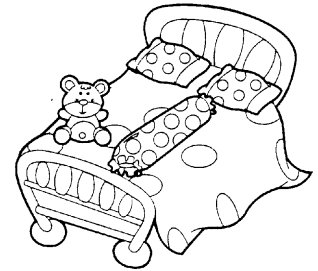

ก

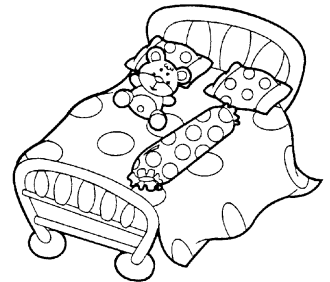

ข

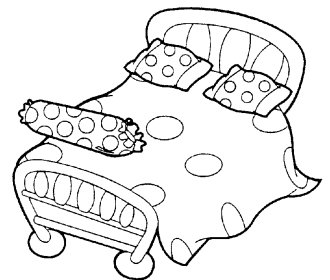

ค

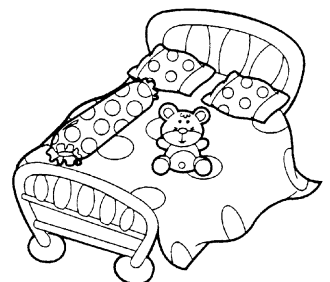

ง

13 ภาพโดมิโนพื้นที่ว่างบนโต๊ะทำงานเท่าภาพแรก

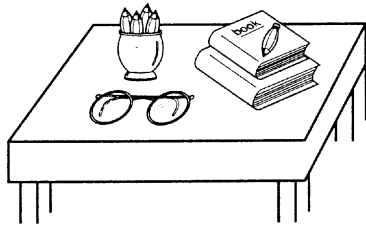
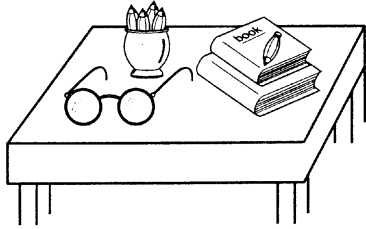

ก

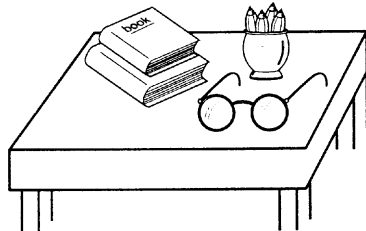

ข

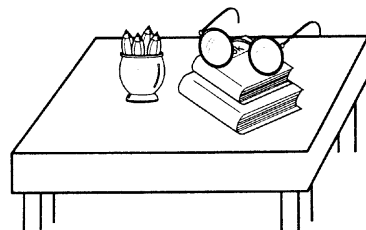

ค

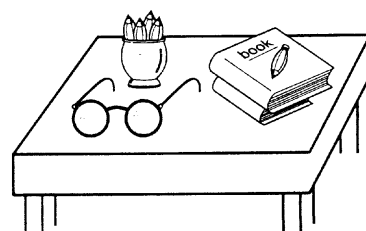

ง

14 ภาพโดมิโนพื้นที่ว่างในตู้เย็นเท่าภาพแรก

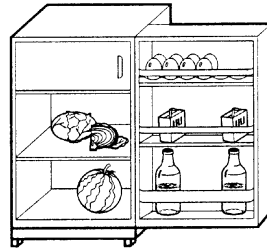
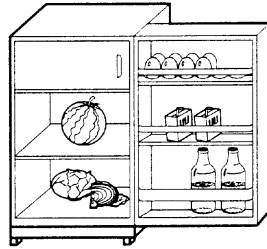

ก

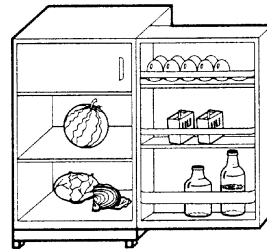

ข

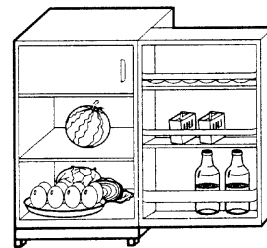

ค

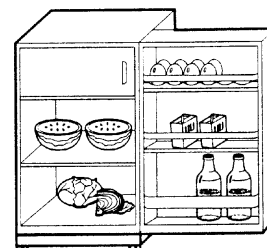

ง

15 ภาพโดมิโนพื้นที่ว่างบนเรือเท่าภาพแรก

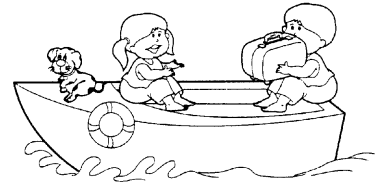

ก



ข

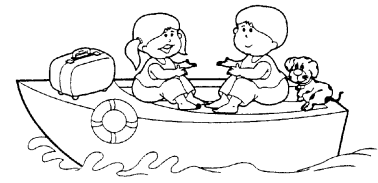

ค

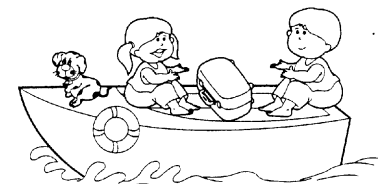

ง

จง X ข้อที่มีชิ้นส่วนที่นำมาเติมภาพที่กำหนดได้พอดี

1

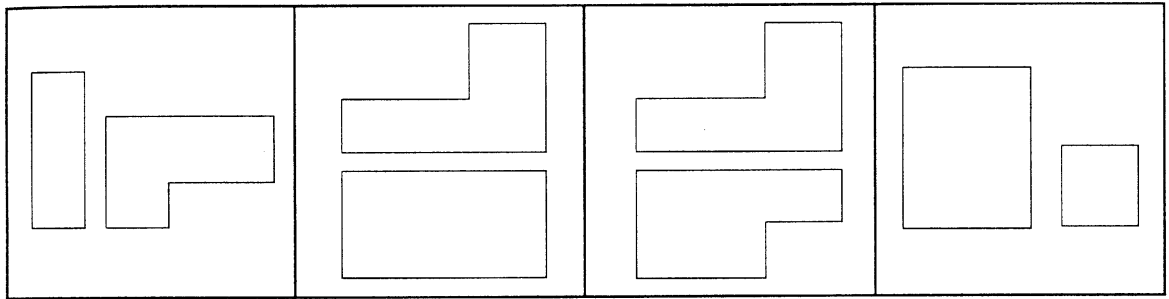
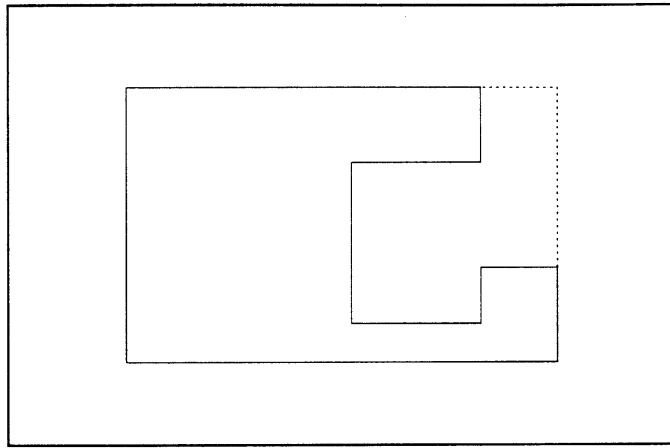

ก

ข

ค

ง

2

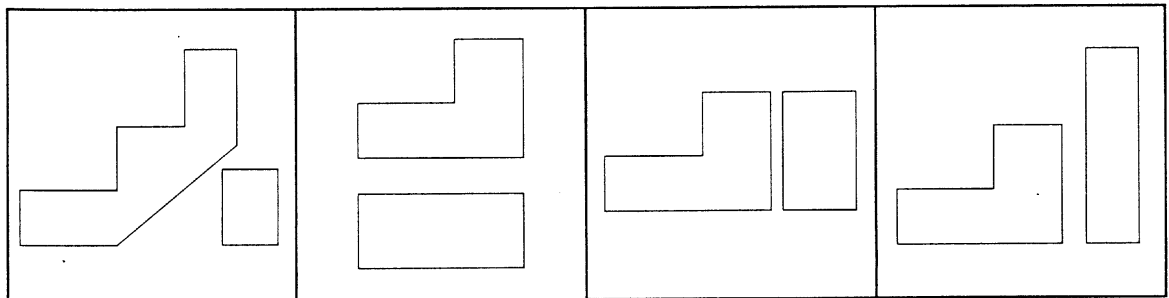
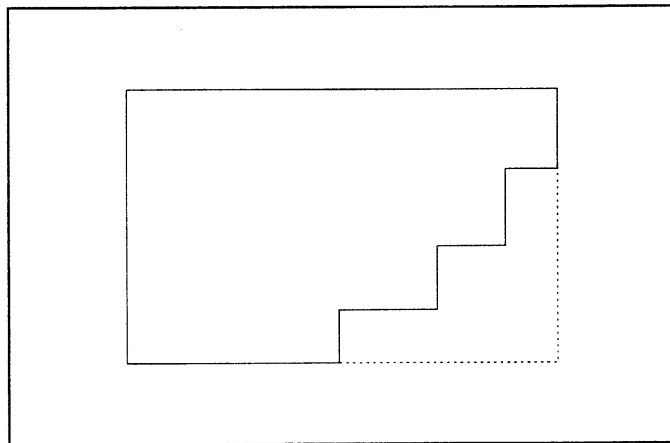

ก

ข

ค

ง

3

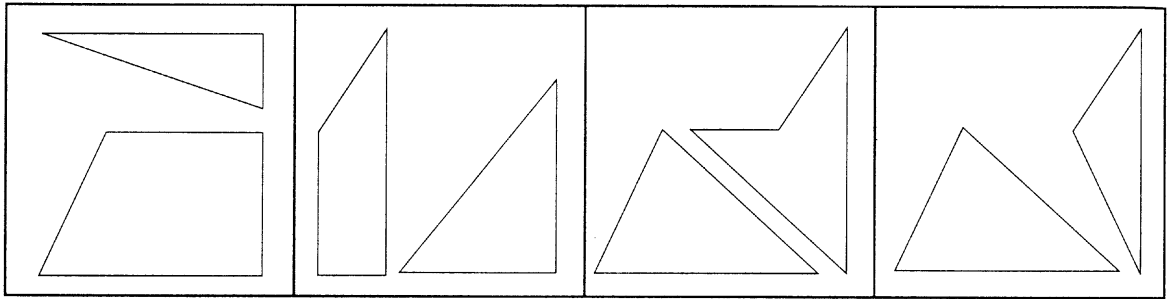
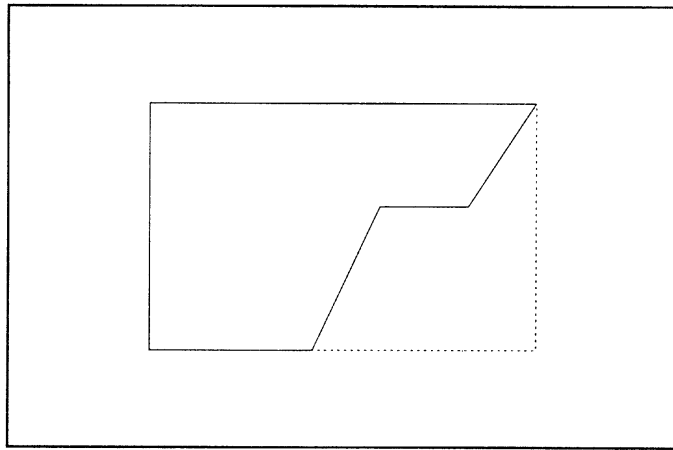

ก

ข

ค

ง

4

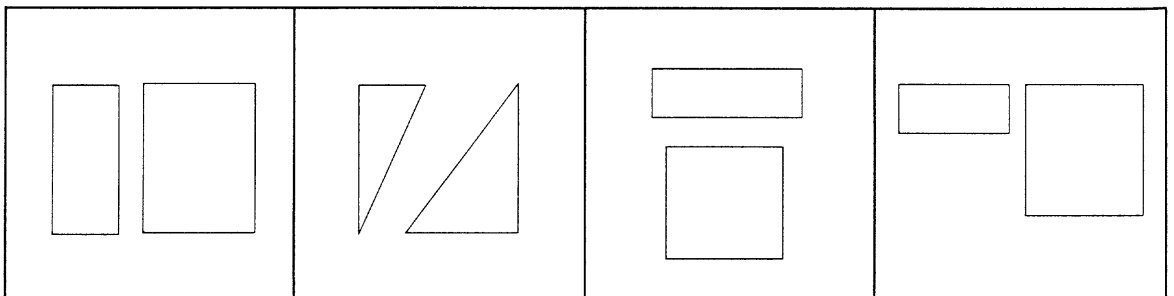
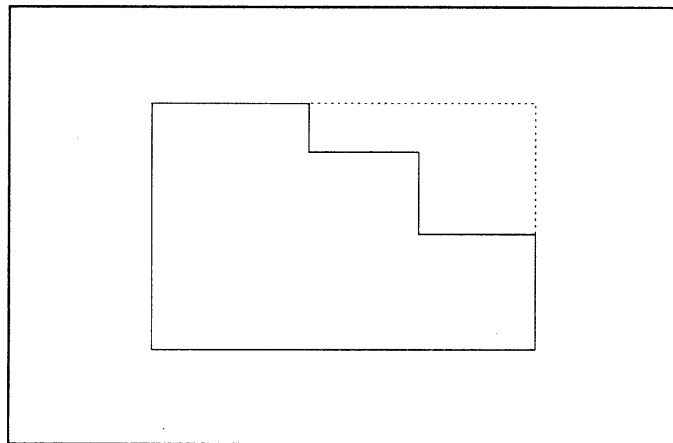

ก

ข

ค

ง

5

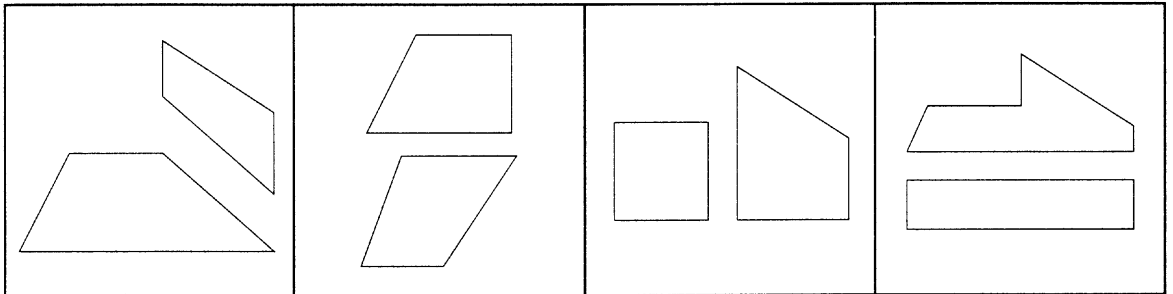
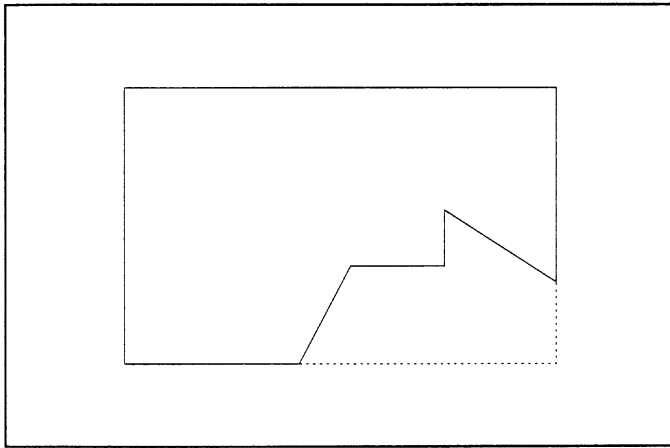

ก

ข

ค

ง

6

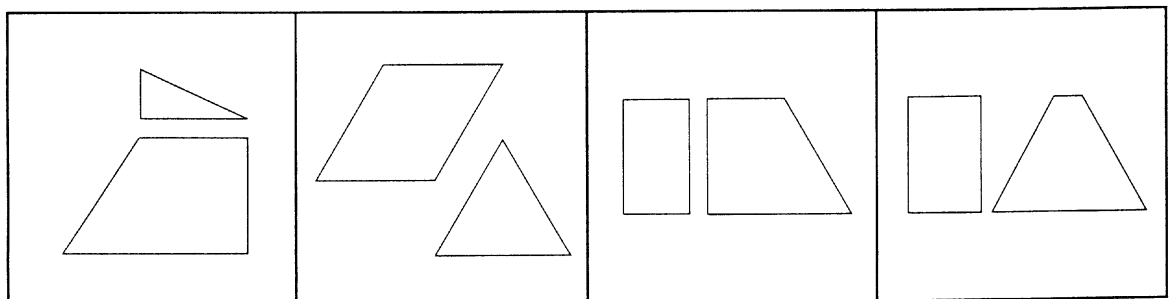
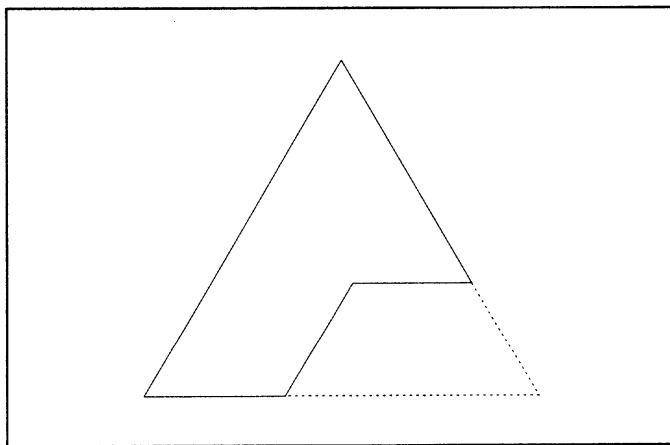

ก

ข

ค

ง

7

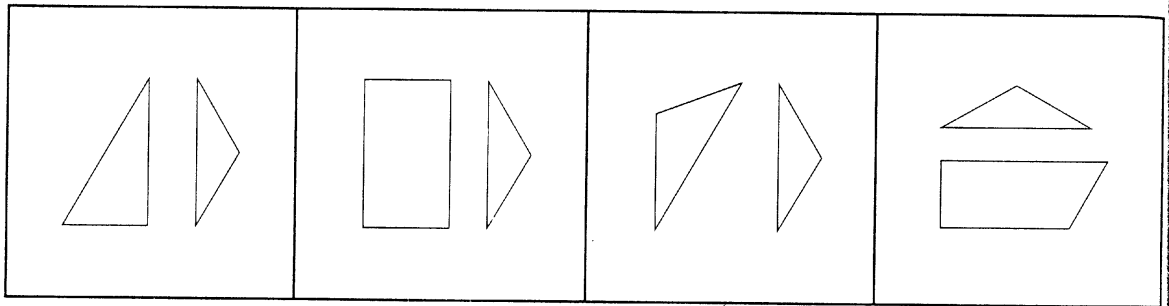
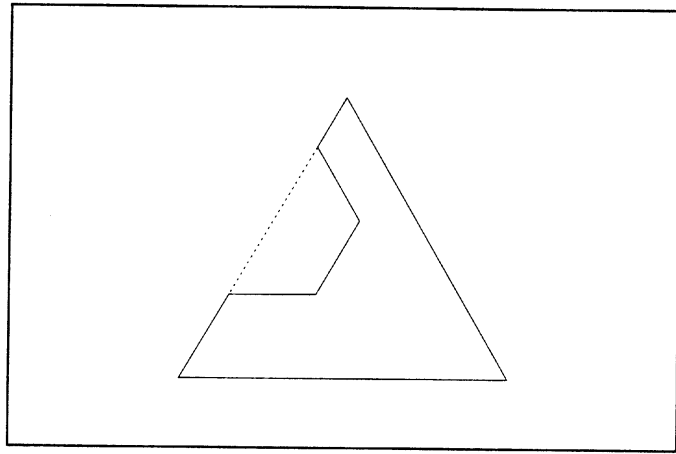

ก

ข

ค

ง

8

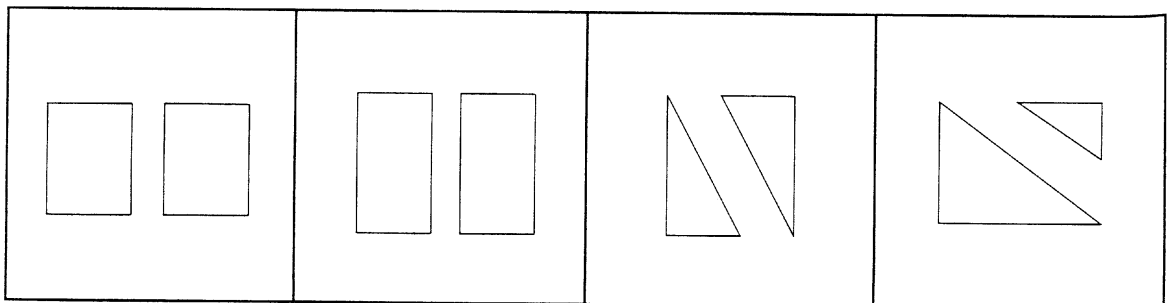
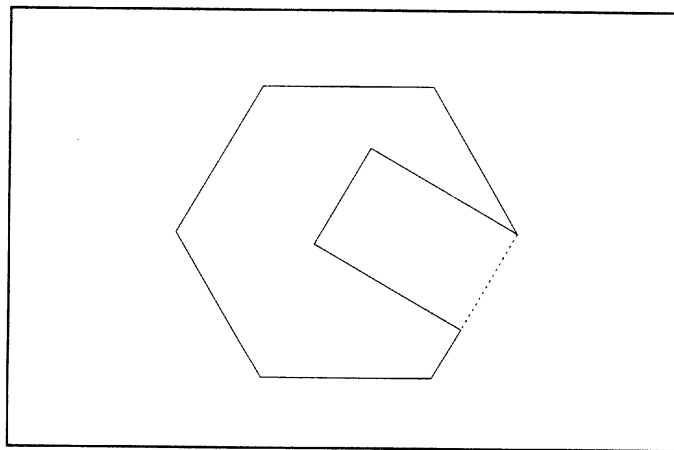

ก

ข

ค

ง

9

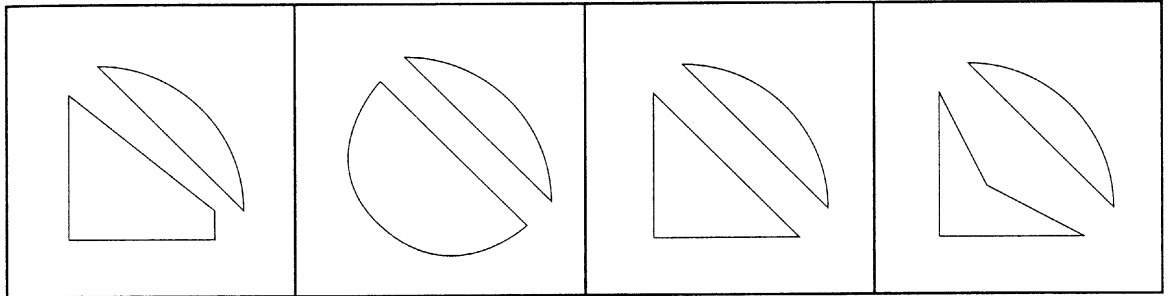
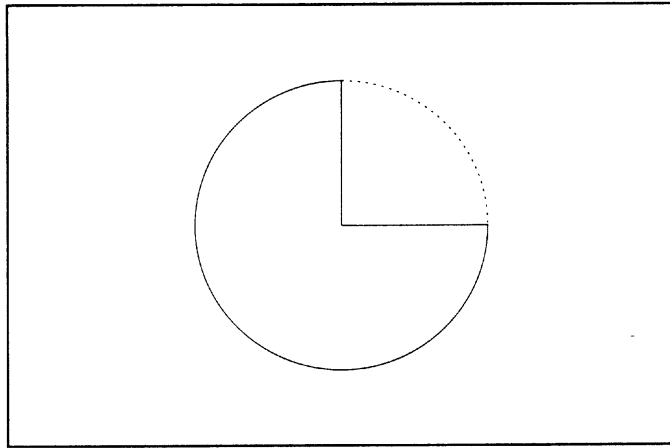

ก

ข

ค

ง

10

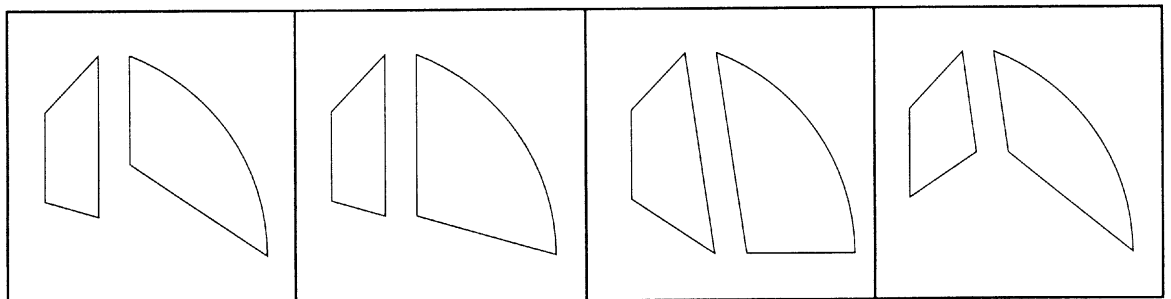
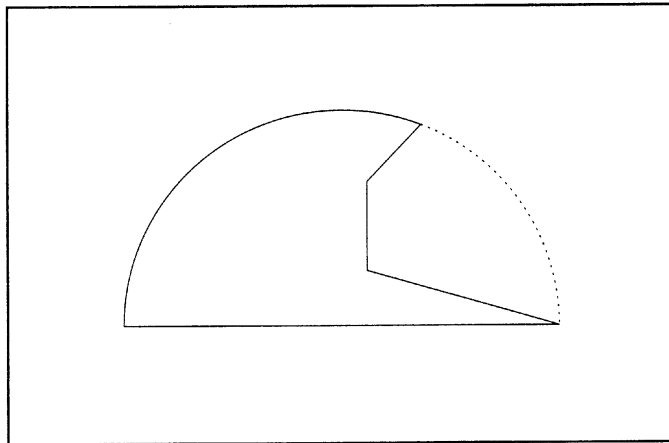

ก

ข

ค

ง

11

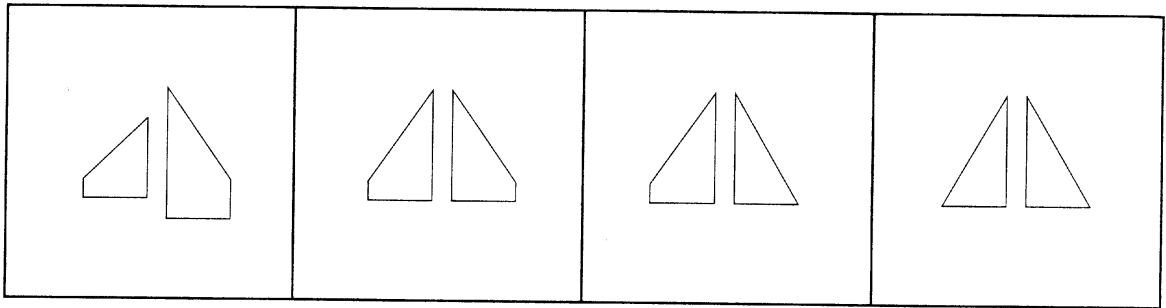
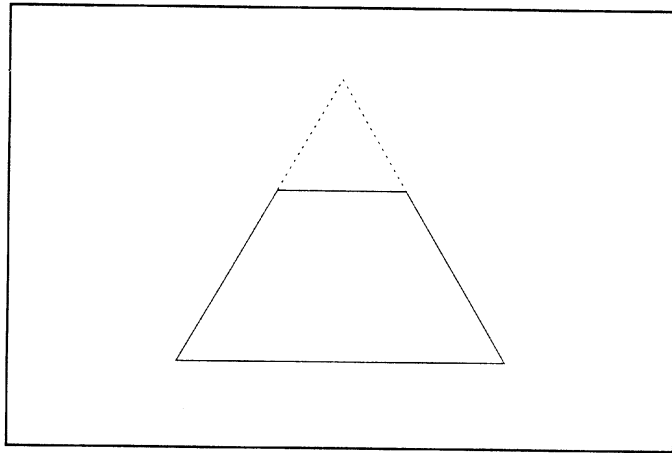

ก

ข

ค

ง

12

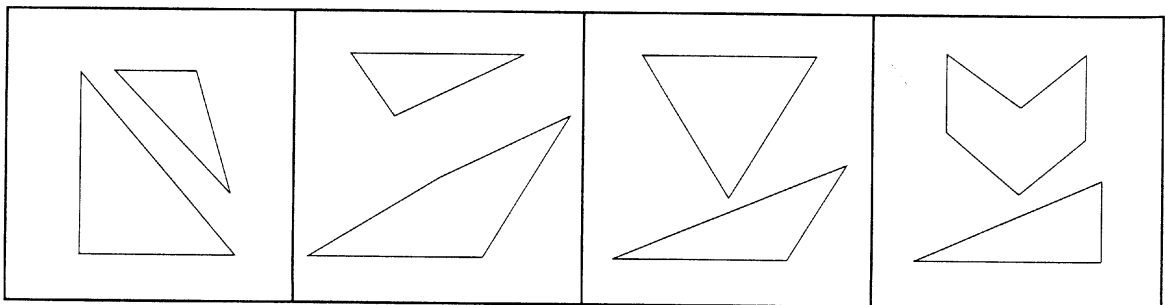
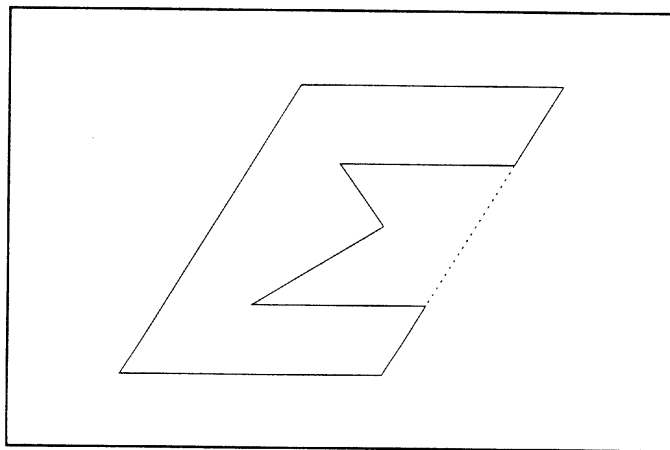

ก

ข

ค

ง

13

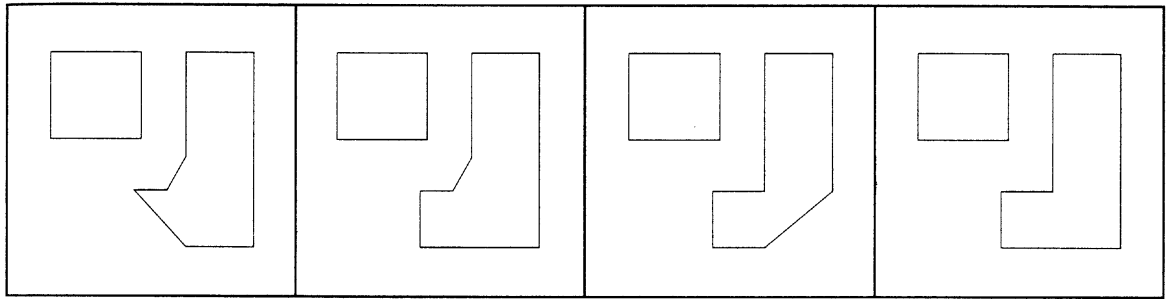
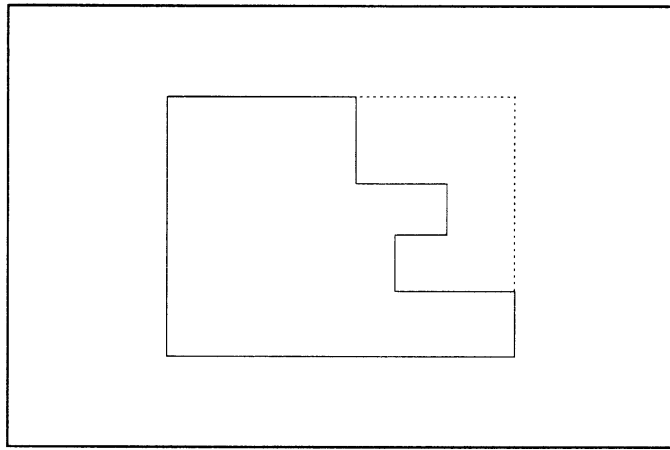

ก

ข

ค

ง

14

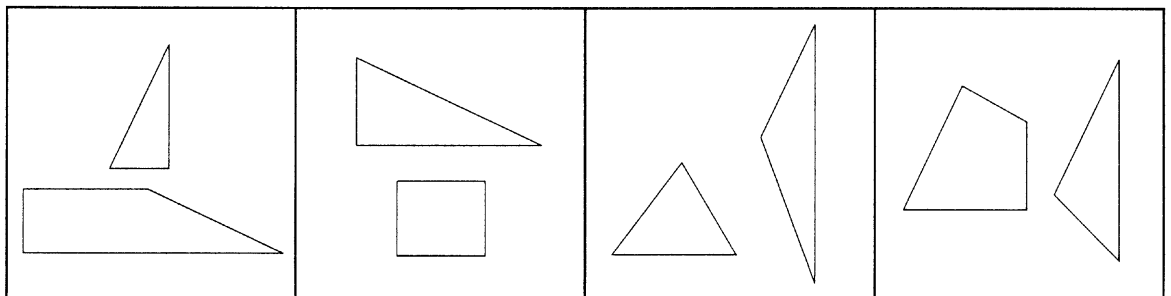
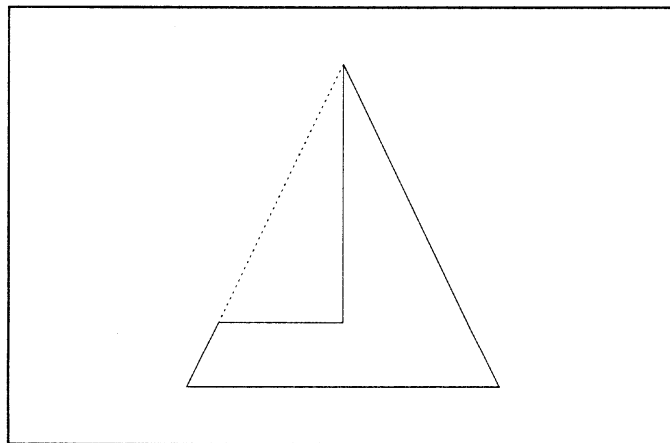

ก

ข

ค

ง

15

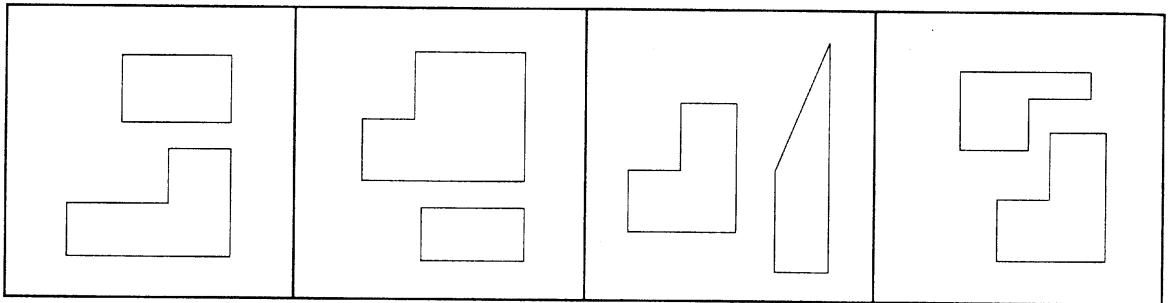
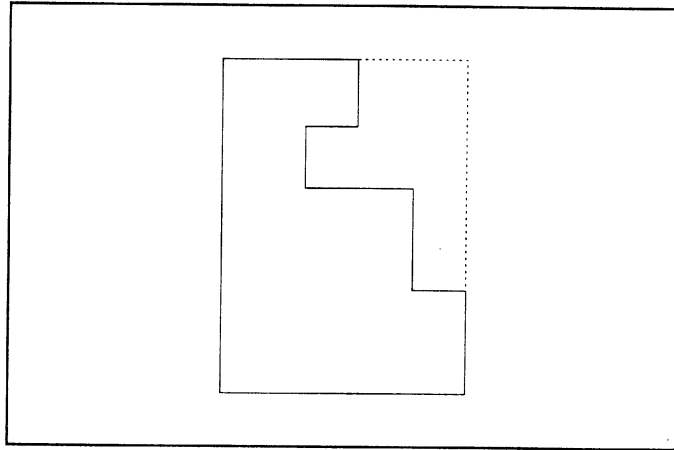

ก

ข

ค

ง

16

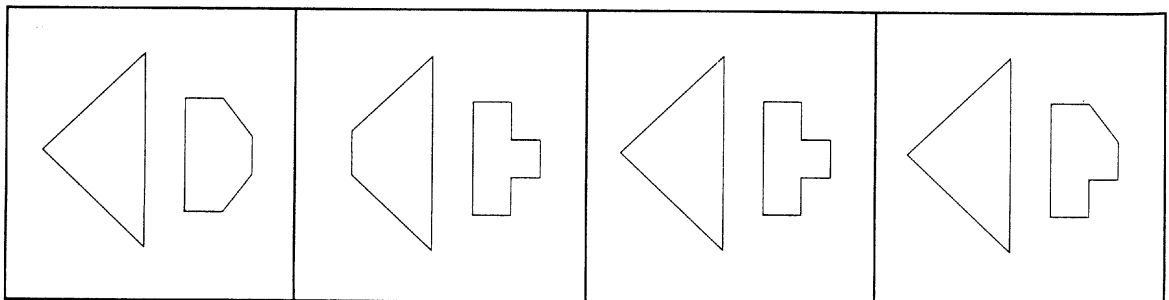
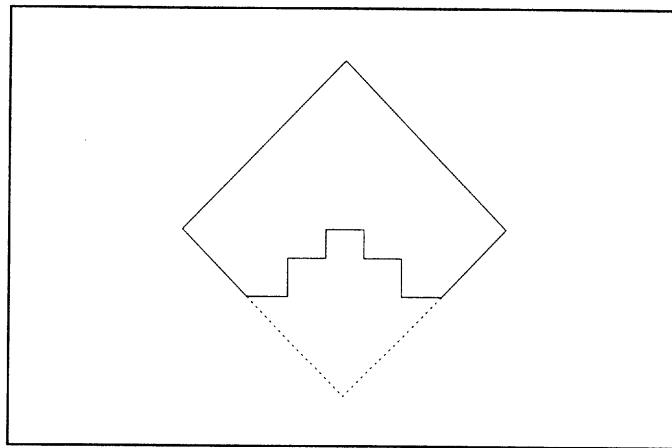

ก

ข

ค

ง

17

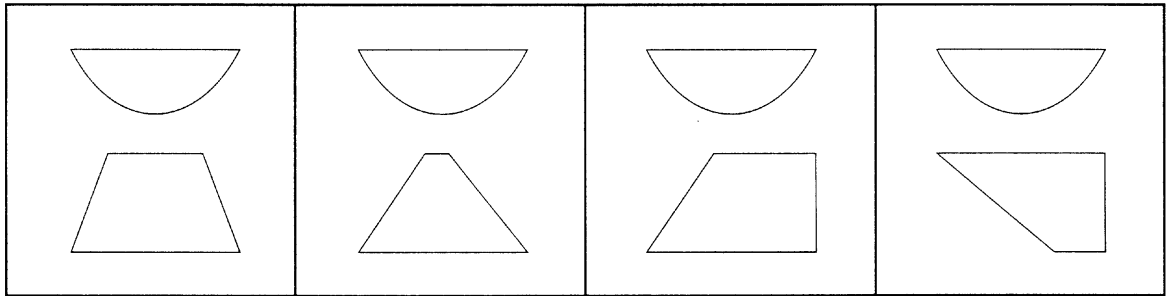
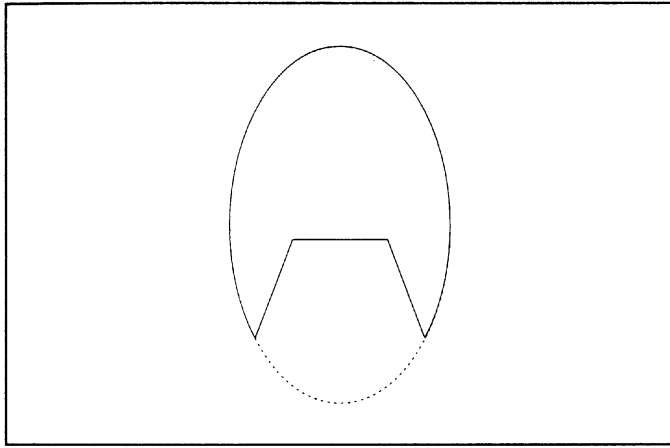

ก

ข

ค

ง

18

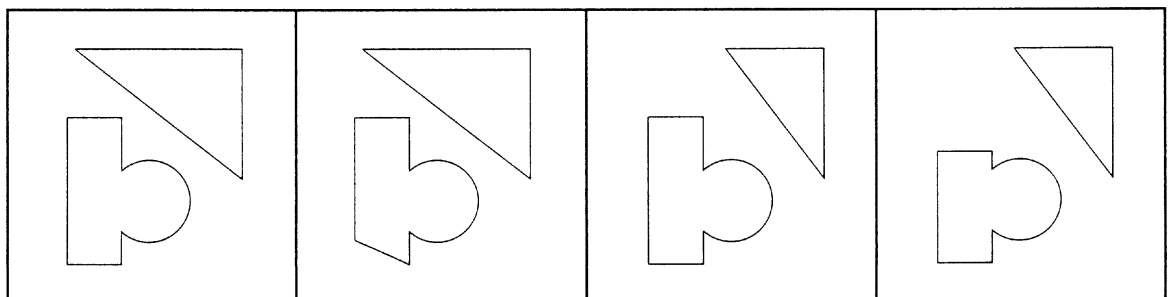
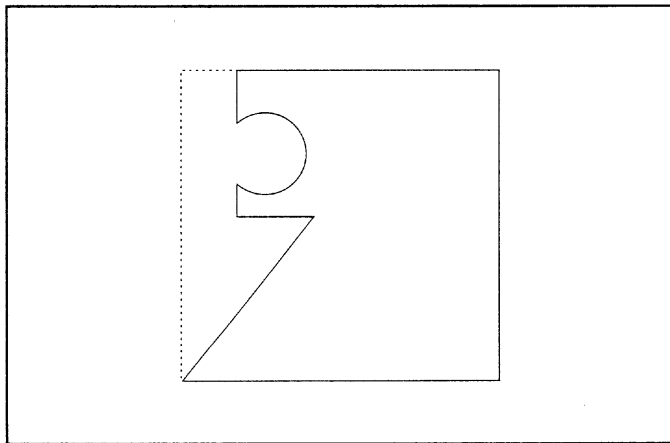

ก

ข

ค

ง

19

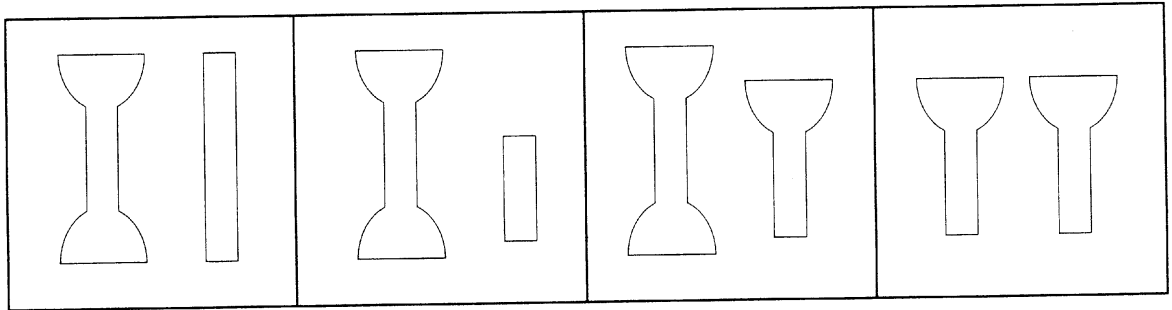
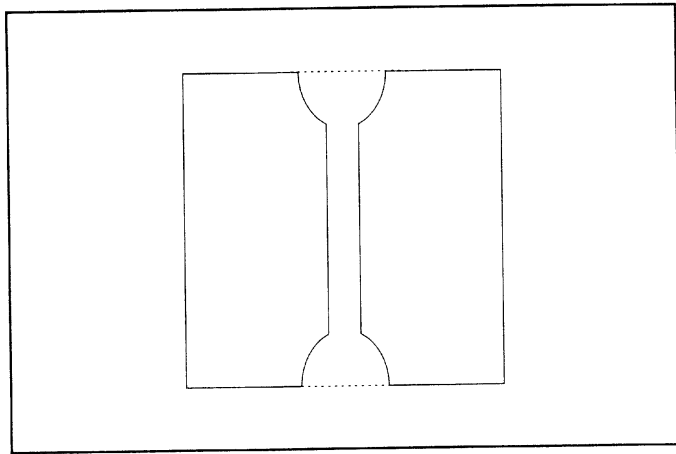

ก

ข

ค

ง

20

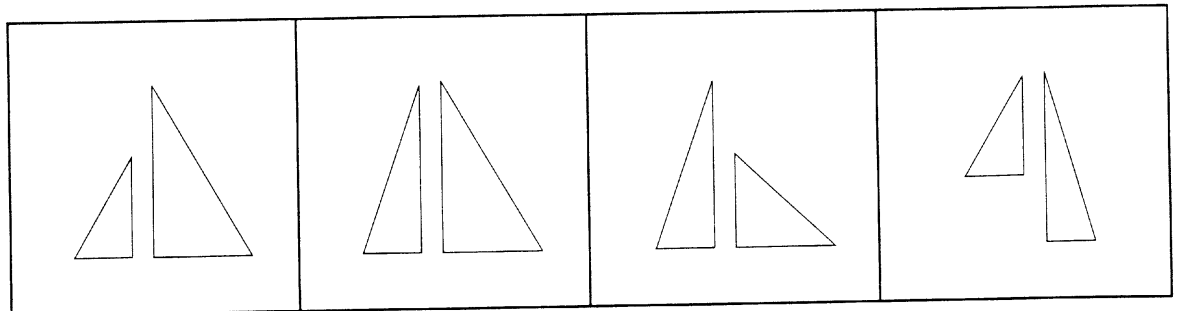
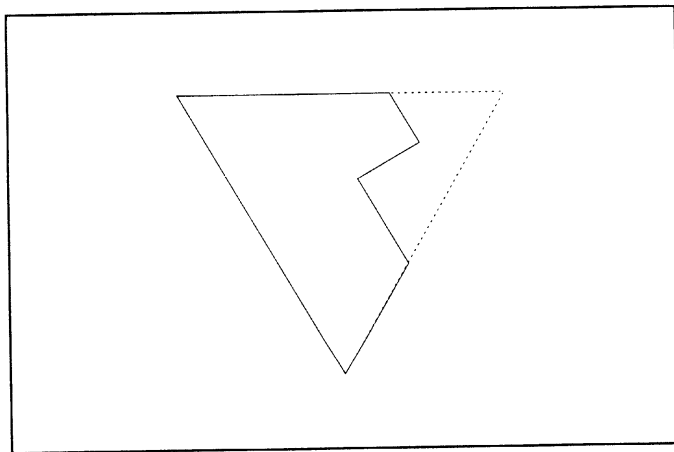

ก

ข

ค

ง

จงขีด ✓ ข้อที่พับแล้วได้กล่องเหมือนภาพในช่องแรก

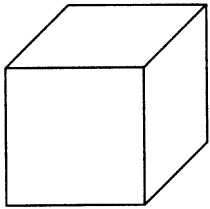
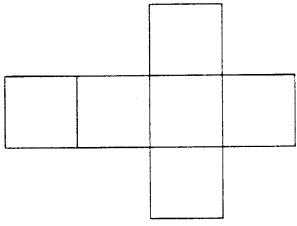
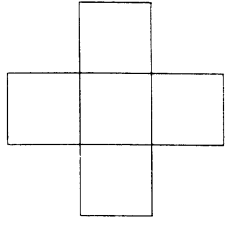
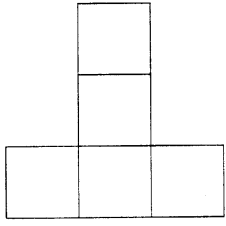
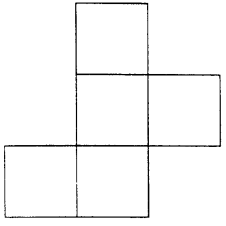
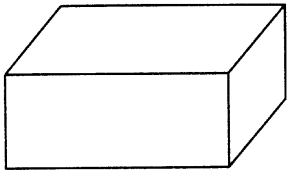
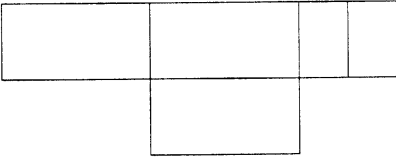
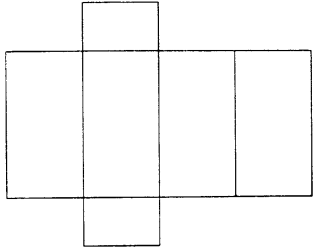
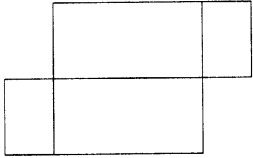
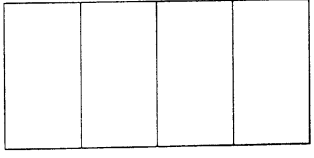
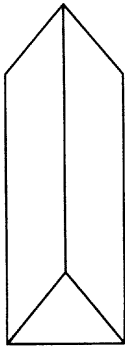
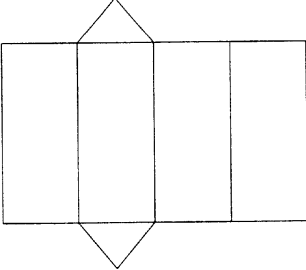
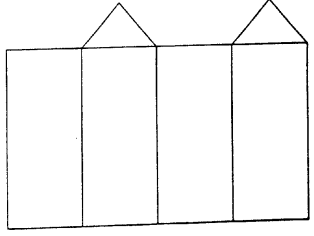
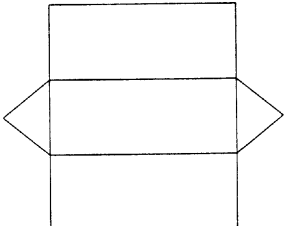
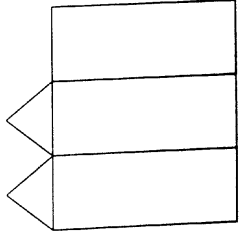
1		 ก	 ข	
		 ค	 ง	
	2		 ก	 ข
			 ค	 ง
3			 ก	 ข
			 ค	 ง

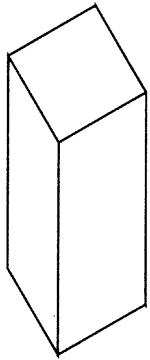
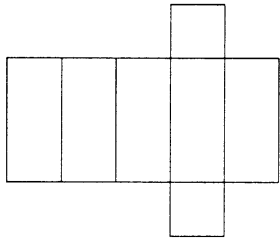
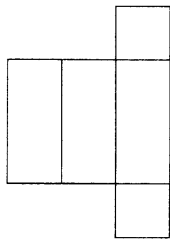
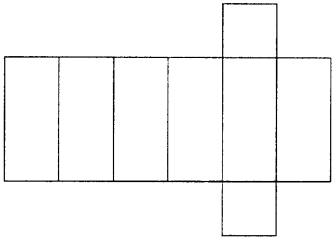
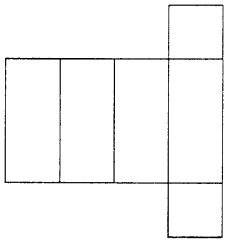
<p>4</p> 	 <p>ဂ</p>	 <p>ဃ</p>
	 <p>င</p>	 <p>စ</p>

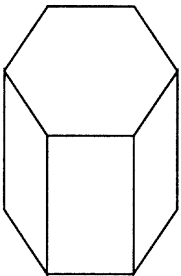
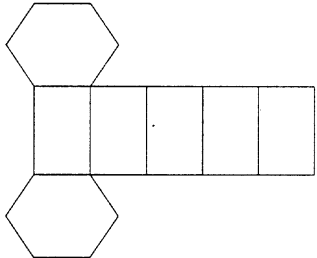
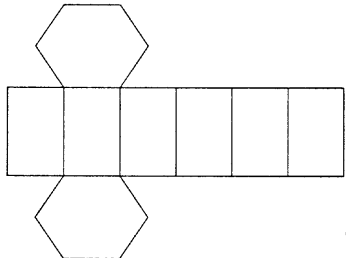
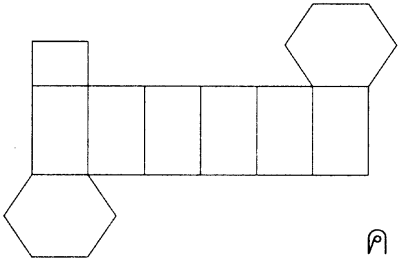
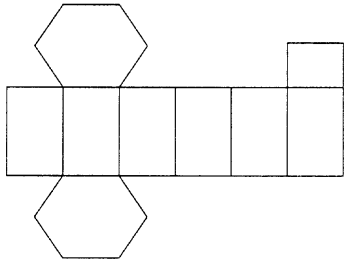
<p>5</p> 	 <p>ဂ</p>	 <p>ဃ</p>
	 <p>င</p>	 <p>စ</p>

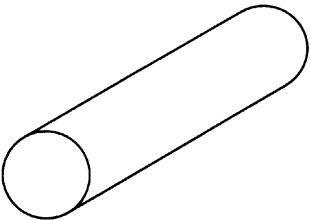
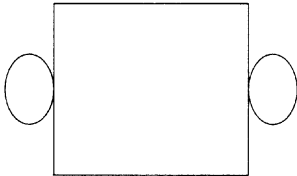
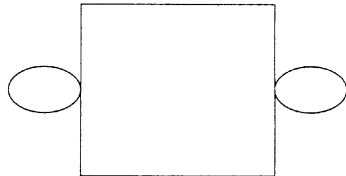
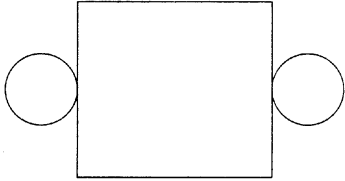
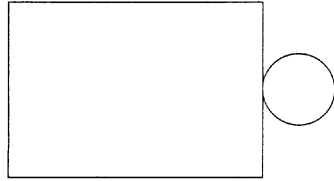
<p>6</p> 	 <p>ဂ</p>	 <p>ဃ</p>
	 <p>င</p>	 <p>စ</p>

7

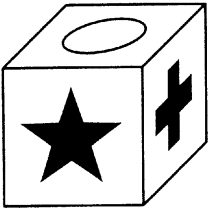

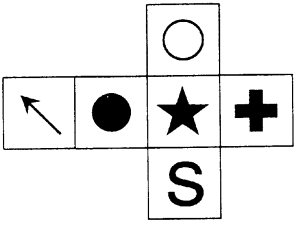

က

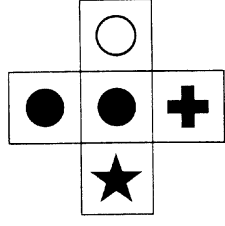

ခ

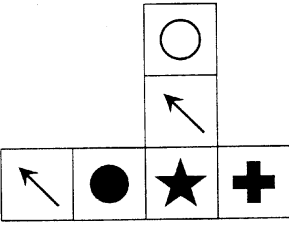

ဂ

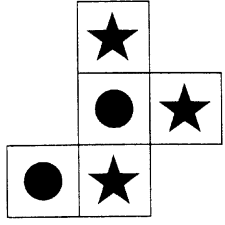

င

8

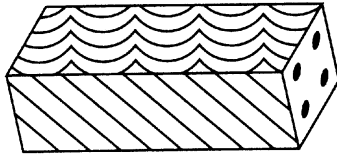

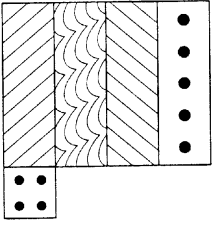

က

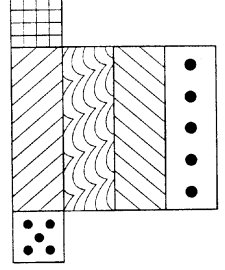

ခ

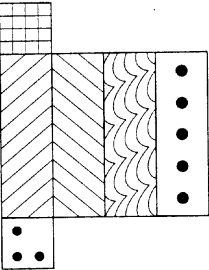

ဂ

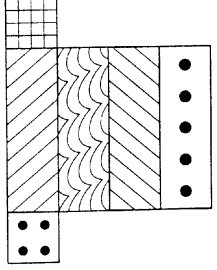

င

9

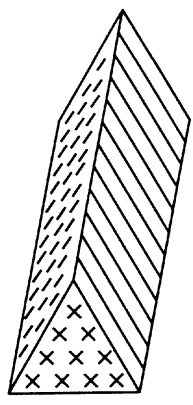

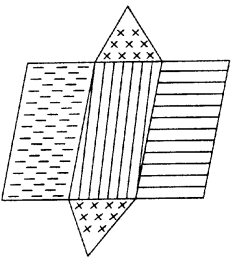

က

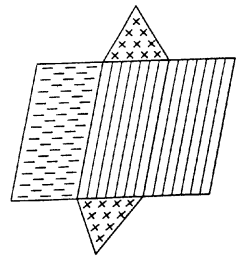

ခ

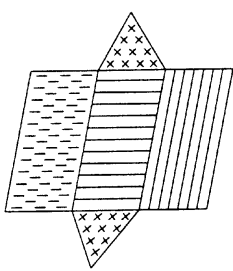

ဂ

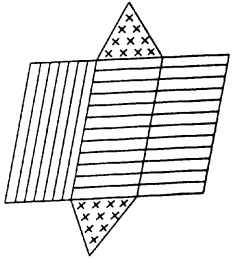

င

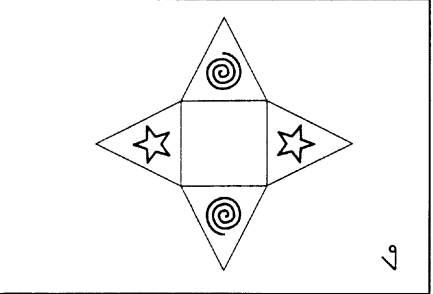
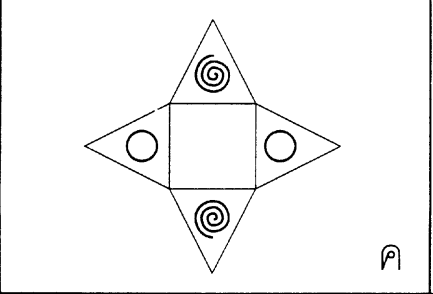
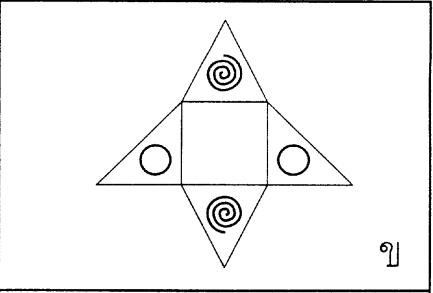
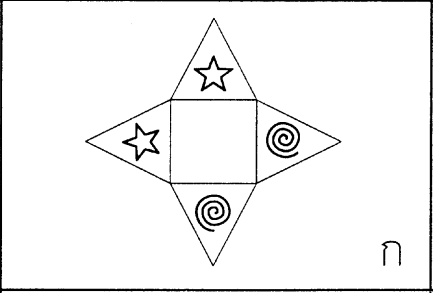
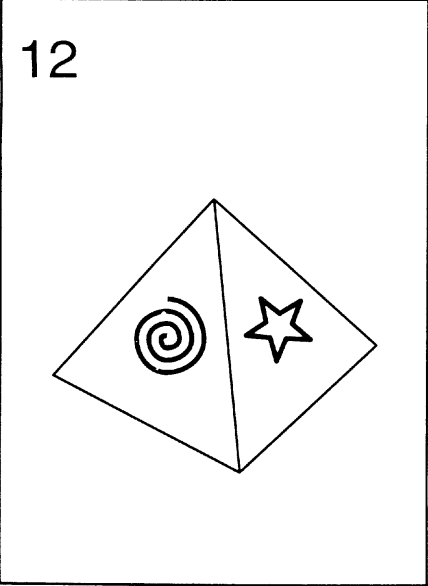
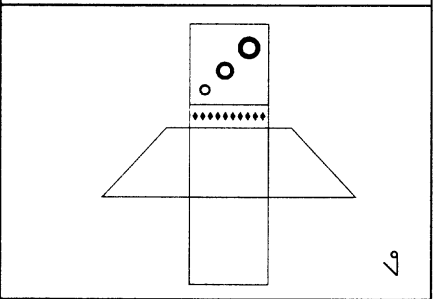
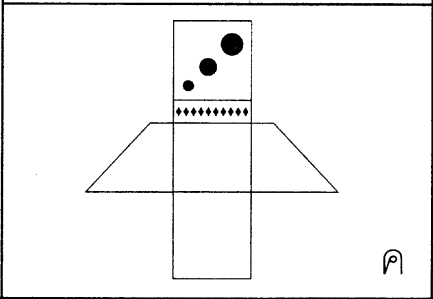
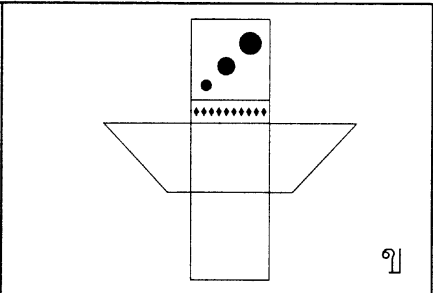
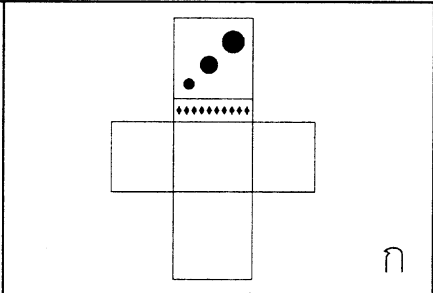
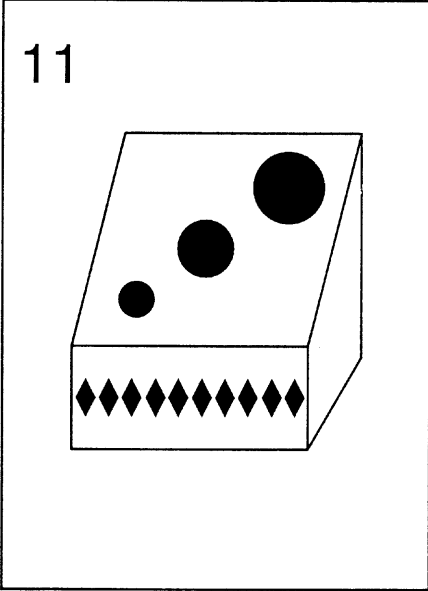
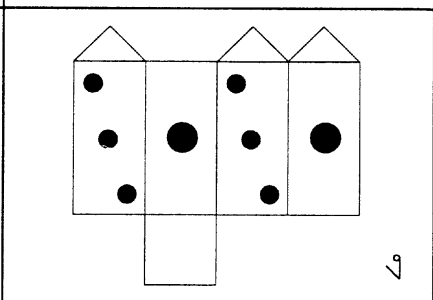
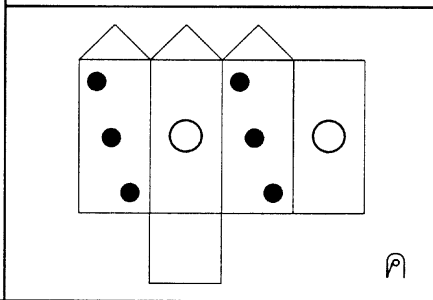
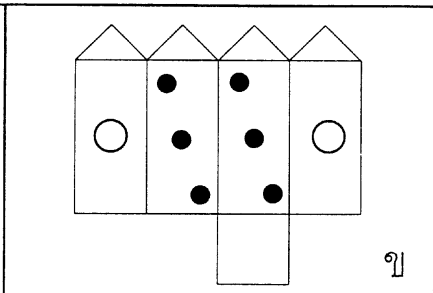
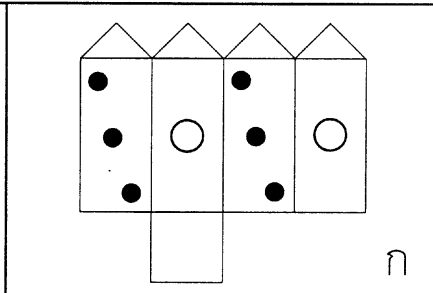
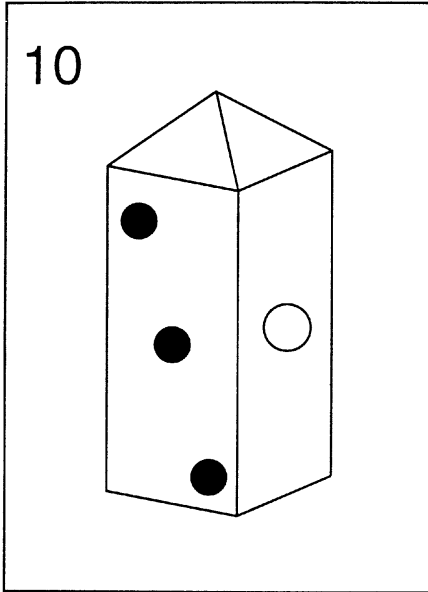

1

1

1

13

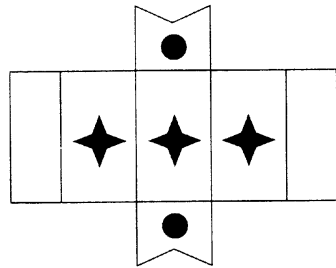
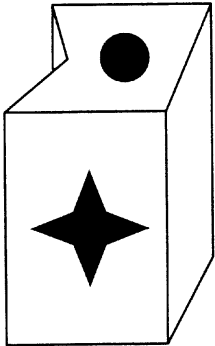

ก

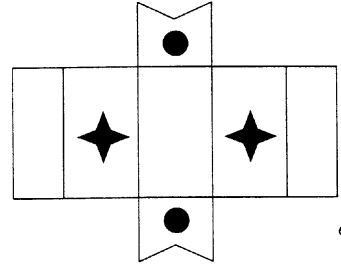

ข

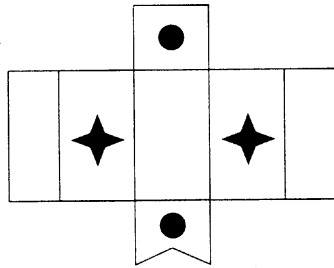

ค

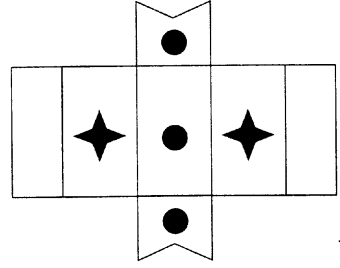

ง

14

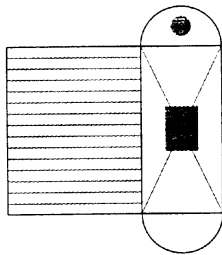
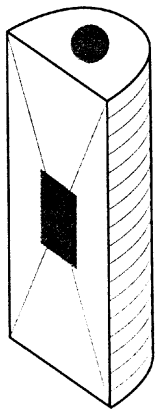

ก

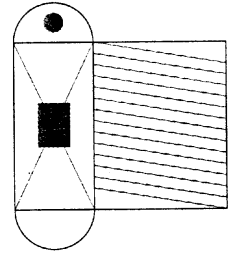

ข

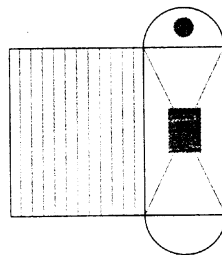

ค

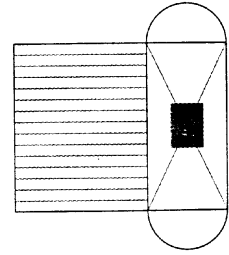

ง

15

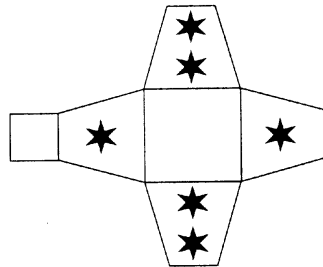
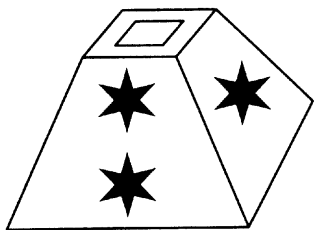

ก

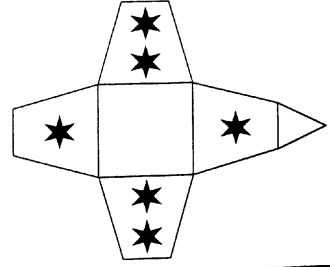

ข

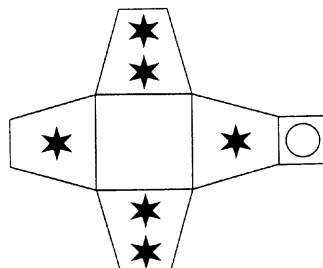

ค

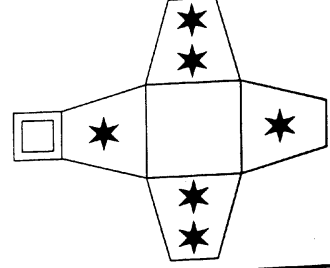

ง

จงขีด ✓ ข้อที่เป็นรูปเต็มของภาพแรกเมื่อกางกระดาษ

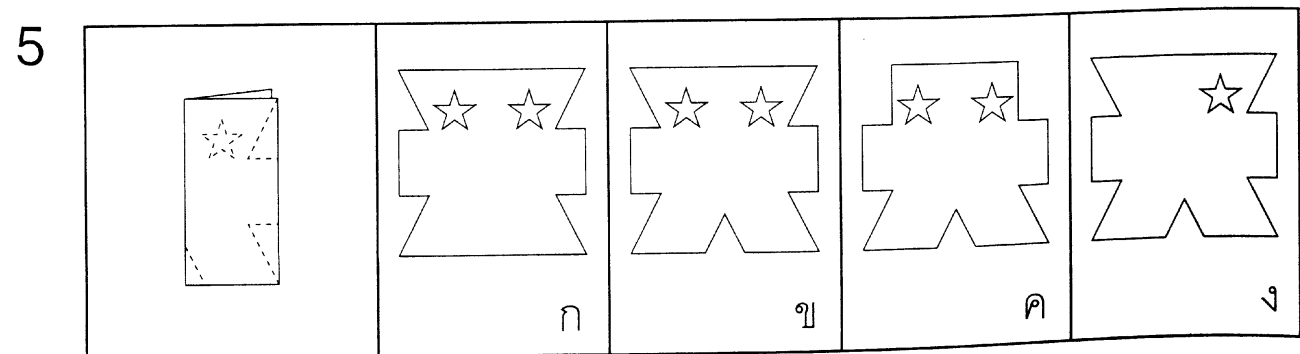
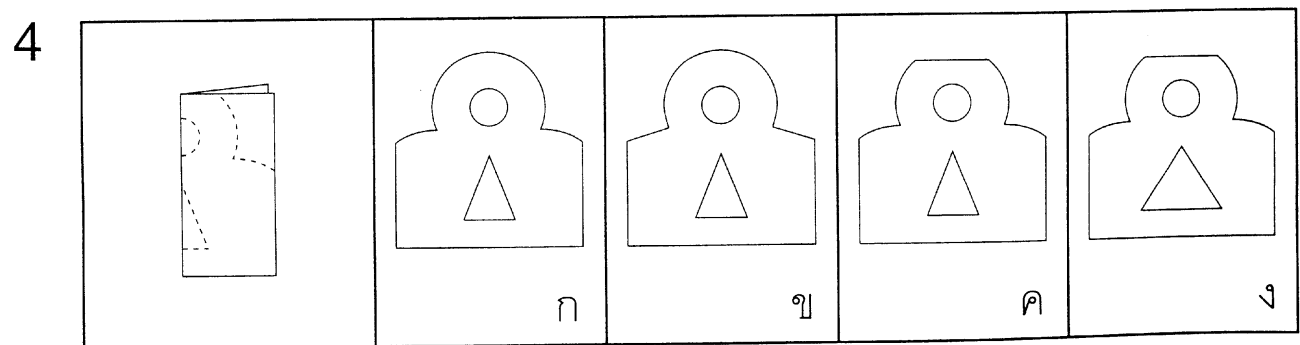
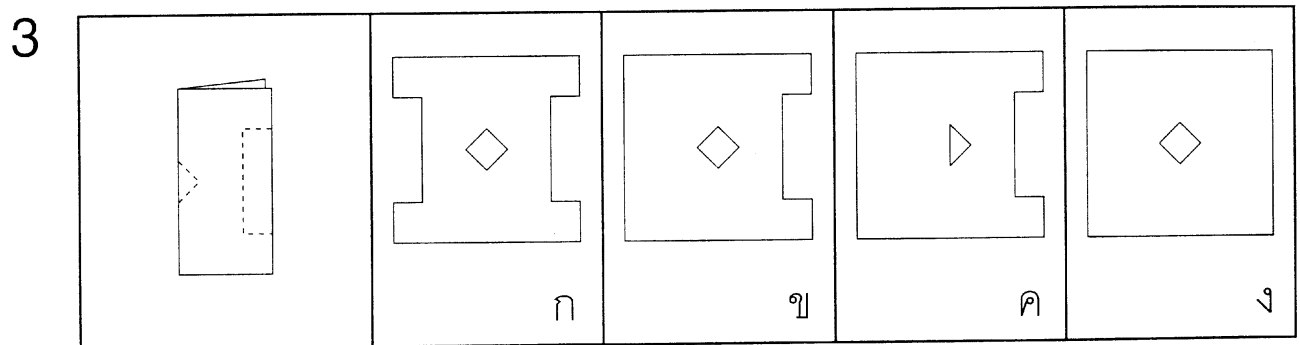
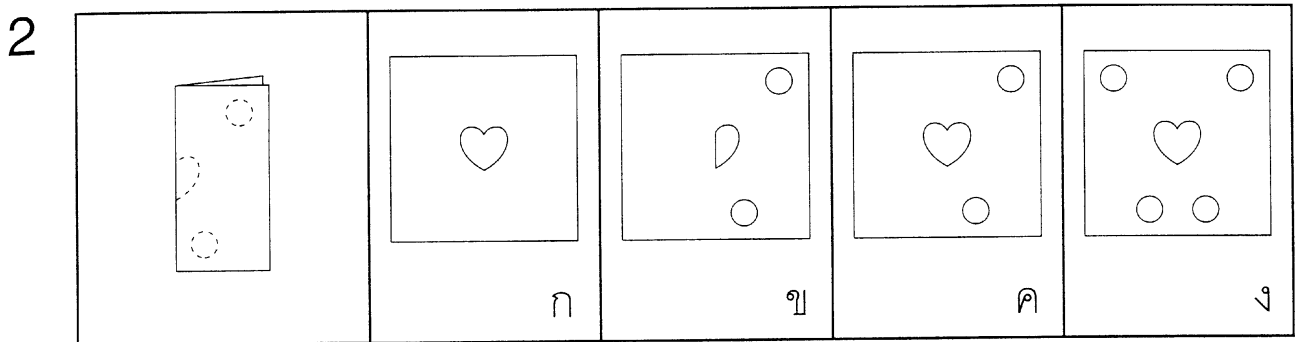
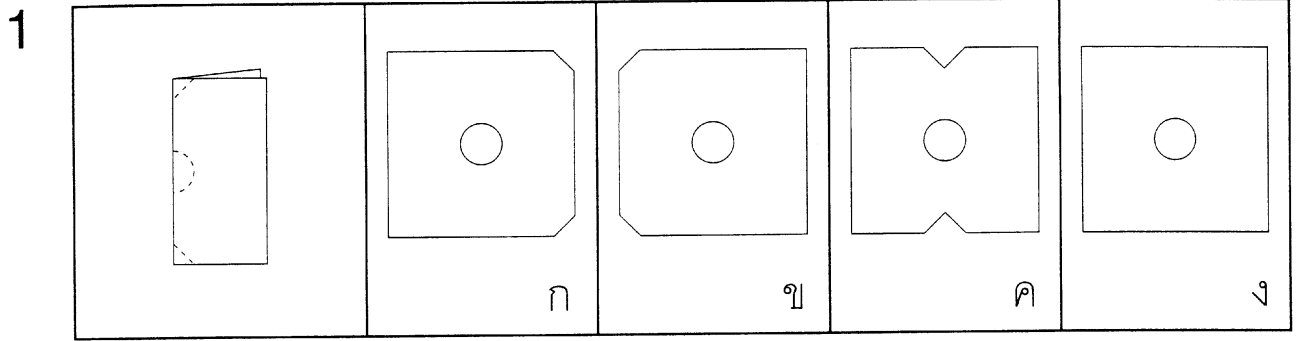

6

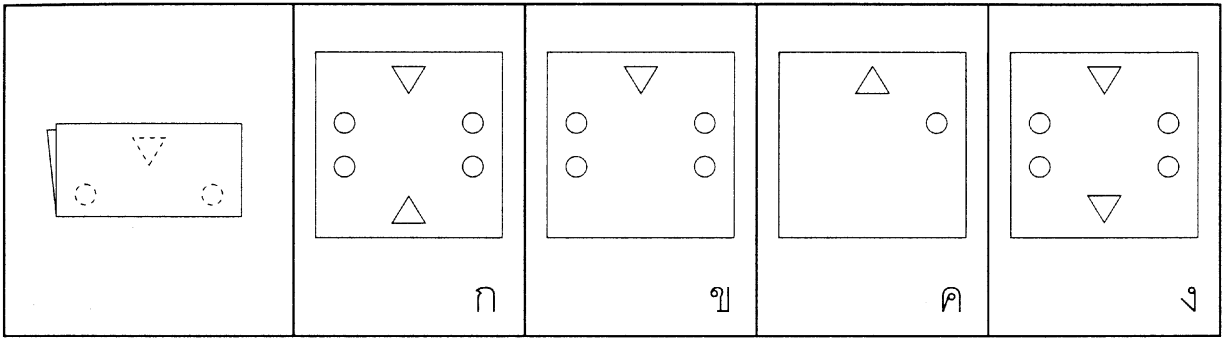

7

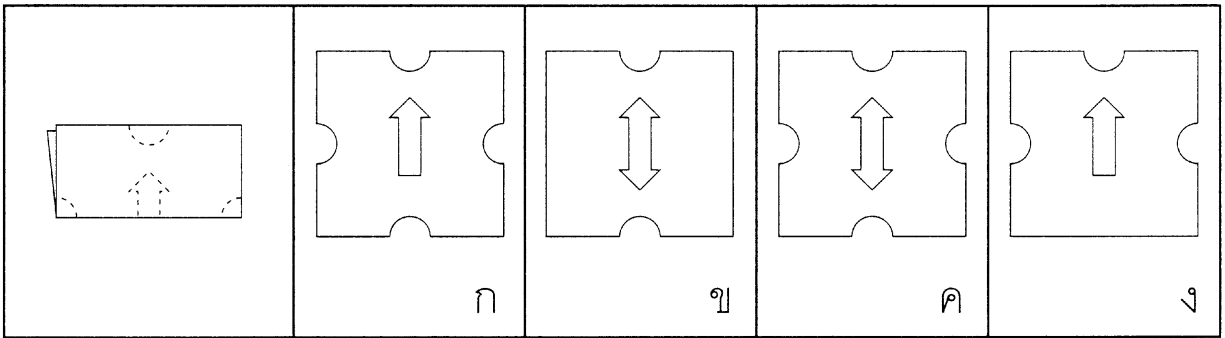

8

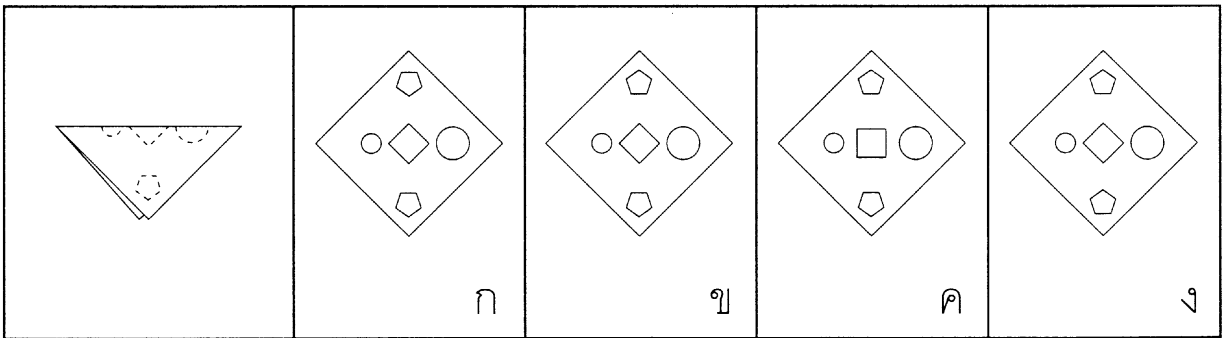

9

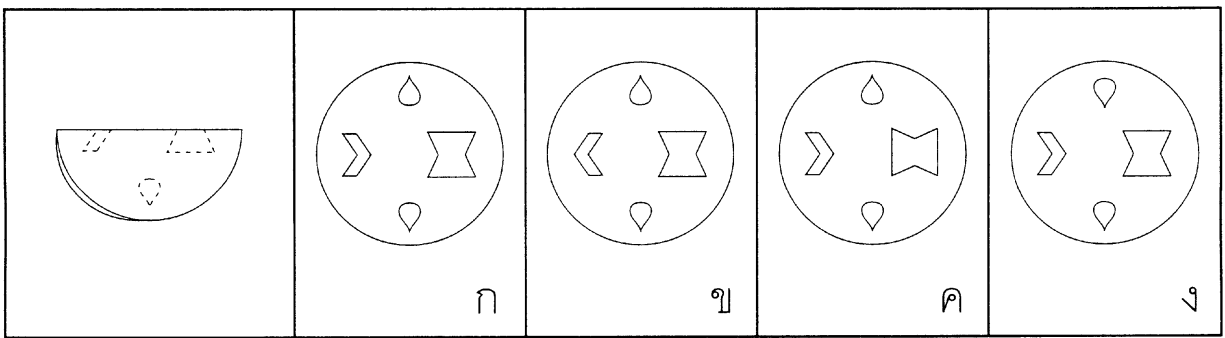

10

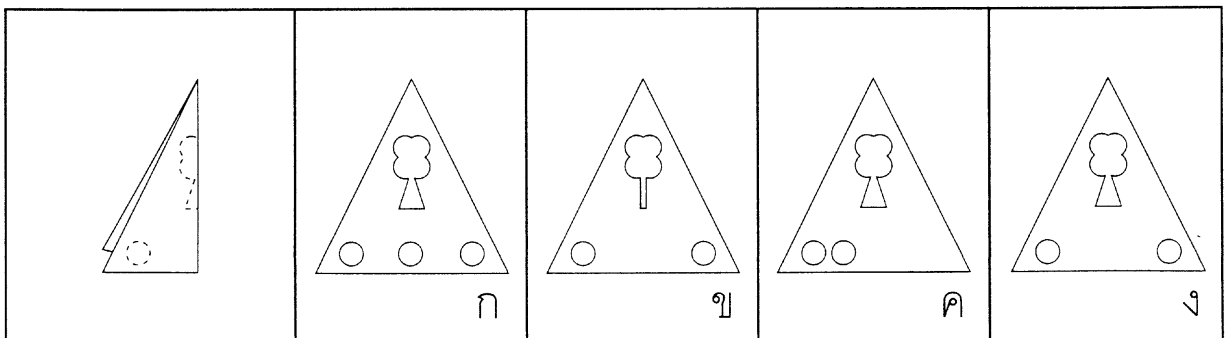

1

1

1

1

1

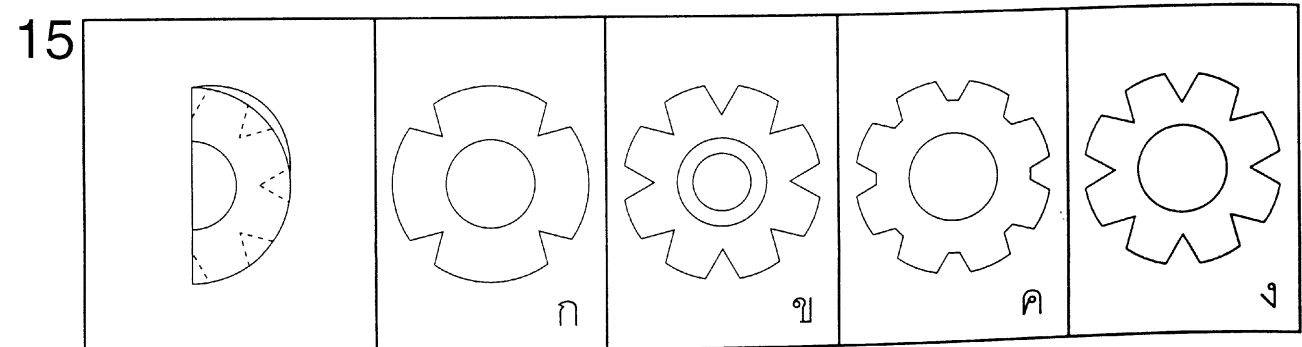
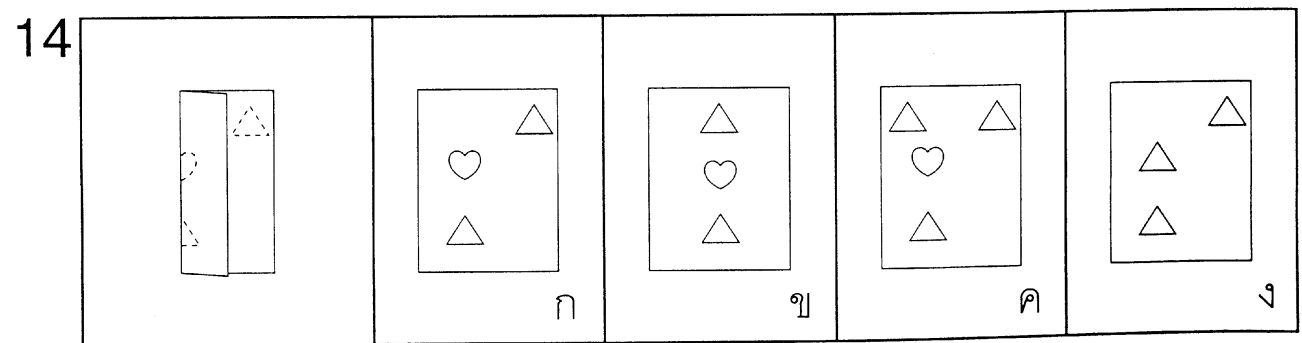
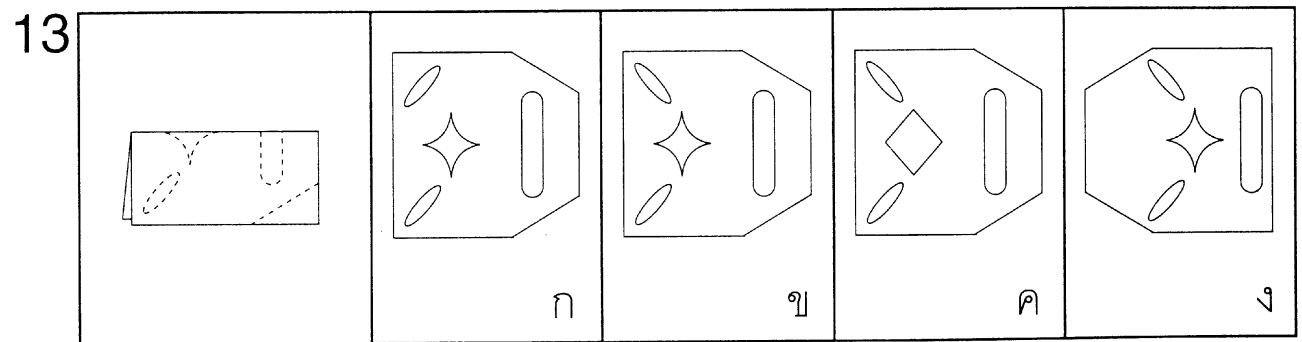
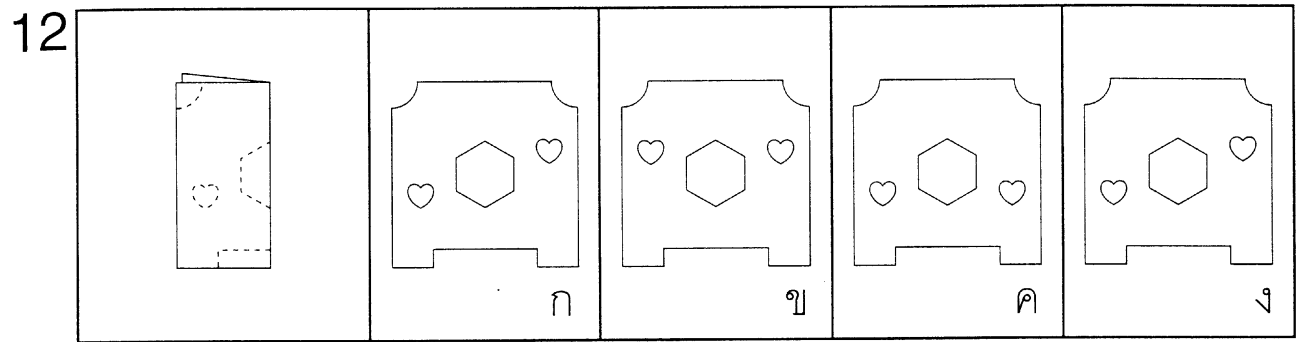
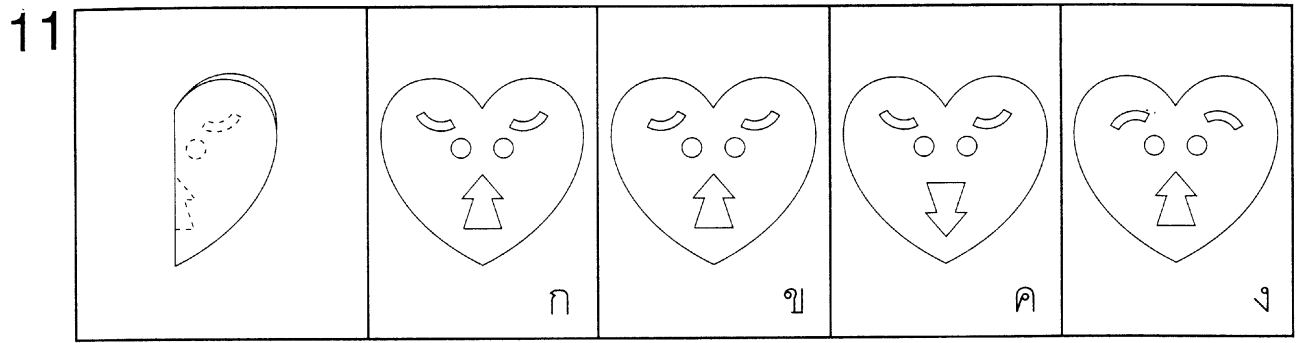

16

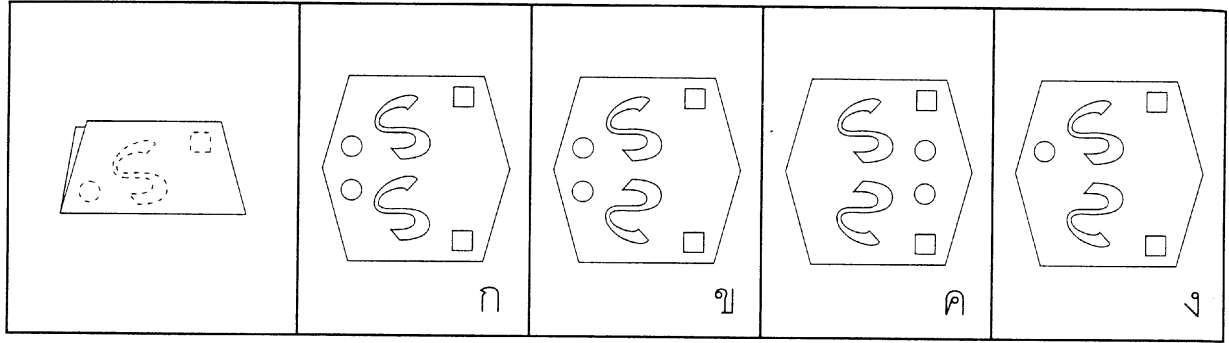

17

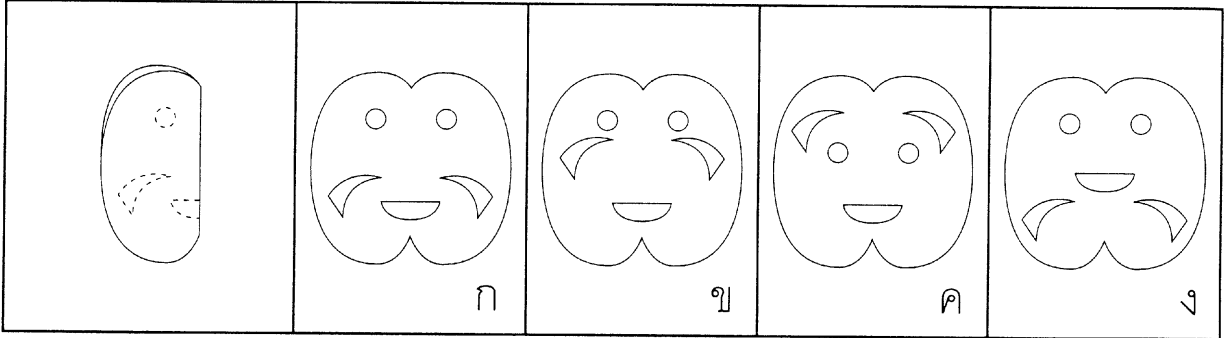

18

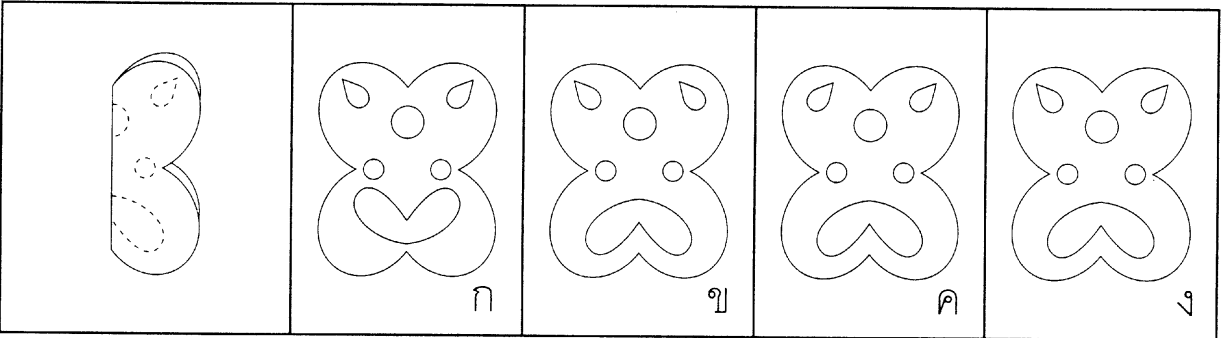

19

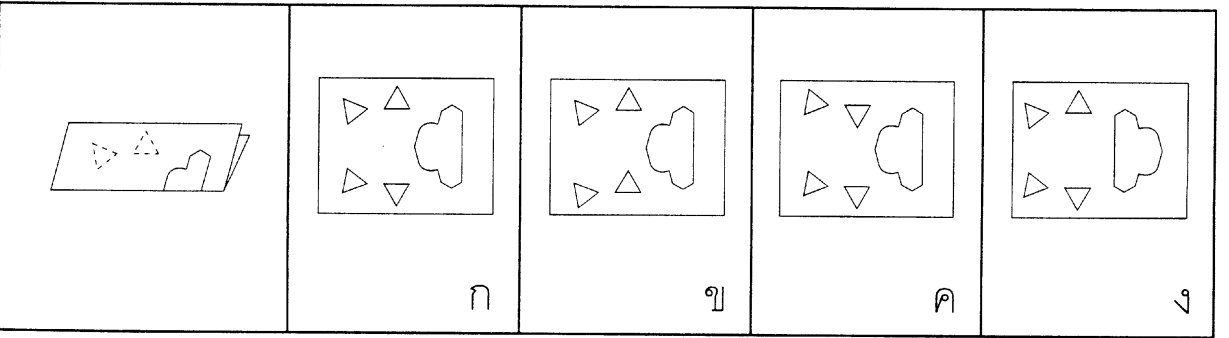

20

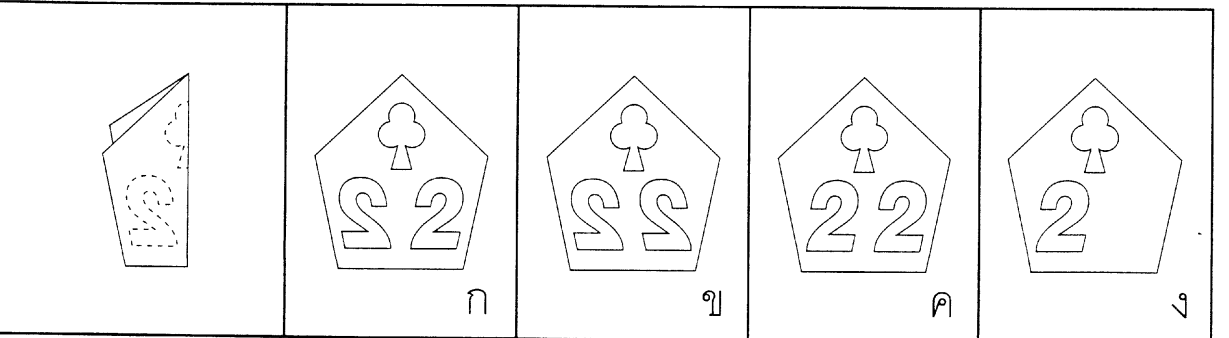



ตอนที่ 1 ความรู้ทางคณิตศาสตร์

หน้า 4

จงขีด ✓ ข้อที่มีจำนวนพระอาทิตย์เท่ากับไม้บล็อก

หน้า 5-8

- | | | | | |
|-------|-------|-------|-------|-------|
| 1. ง | 2. ง | 3. ค | 4. ค | 5. ง |
| 6. ง | 7. ข | 8. ค | 9. ค | 10. ก |
| 11. ง | 12. ข | 13. ง | 14. ค | 15. ง |
| 16. ข | 17. ข | 18. ข | 19. ค | 20. ก |

จงขีด ✓ ข้อที่มีจำนวนเท่ากับภาพในช่องแรก

หน้า 9-10

- | | | | | |
|------|------|------|------|-------|
| 1. ค | 2. ข | 3. ง | 4. ก | 5. ง |
| 6. ง | 7. ข | 8. ก | 9. ข | 10. ง |

จง ○ ข้อที่มีจำนวนมากกว่าภาพในช่องแรก

หน้า 11-12

- | | | | | |
|------|------|------|------|-------|
| 1. ง | 2. ก | 3. ค | 4. ข | 5. ก |
| 6. ง | 7. ค | 8. ข | 9. ค | 10. ข |

จงขีด ✓ ข้อที่มีจำนวนน้อยกว่าภาพในช่องแรก

หน้า 13-14

- | | | | | |
|------|------|------|------|-------|
| 1. ข | 2. ก | 3. ค | 4. ง | 5. ก |
| 6. ก | 7. ข | 8. ค | 9. ง | 10. ง |

จงขีด X ข้อที่มีจำนวนใกล้เคียงกับภาพแรกในช่องแรก

หน้า 15-16

- | | | | | |
|------|------|---------|------|-------|
| 1. ง | 2. ก | 3. ข | 4. ข | 5. ค |
| 6. ข | 7. ง | 8. ก, ค | 9. ง | 10. ข |

อ่านคำถามแต่ละข้อให้นักเรียนฟังแล้วให้ ✓ ทับข้อที่ถูกต้อง

หน้า 17-26

- | | | | | |
|-------|-------|-------|-------|-------|
| 1. ค | 2. ก | 3. ค | 4. ง | 5. ข |
| 6. ก | 7. ค | 8. ข | 9. ค | 10. ง |
| 11. ก | 12. ข | 13. ง | 14. ค | 15. ก |
| 16. ข | 17. ง | 18. ข | 19. ก | 20. ง |
| 21. ข | 22. ก | 23. ค | 24. ข | 25. ง |
| 26. ข | 27. ก | 28. ข | 29. ค | 30. ค |

จมนับจำนวนกล่องสีขาวยที่สัมผัสกับกล่องสีเทาแล้ว X ข้อที่ถูกต้อง

หน้า 27-31

- | | | | | |
|-------|-------|-------|-------|-------|
| 1. ง | 2. ง | 3. ข | 4. ค | 5. ข |
| 6. ง | 7. ง | 8. ง | 9. ค | 10. ก |
| 11. ข | 12. ก | 13. ข | 14. ข | 15. ก |
| 16. ค | 17. ค | 18. ข | 19. ง | 20. ก |

จงขีด ✓ ข้อที่พบแล้วได้กล่องเหมือนภาพในช่องแรก

หน้า 63-67

- | | | | | |
|-------|-------|-------|-------|-------|
| 1. ก | 2. ข | 3. ค | 4. ง | 5. ข |
| 6. ค | 7. ก | 8. ง | 9. ค | 10. ก |
| 11. ค | 12. ง | 13. ข | 14. ก | 15. ง |

ตอนที่ 4 การเปรียบเทียบ ปริมาณ
น้ำหนัก ระยะทาง พื้นที่ว่าง

หน้า 68

จงหาความสัมพันธ์ของปริมาณน้ำที่กำหนดในภาพแรกโดย ✓ หน้าข้อ

หน้า 69-73

- | | | | | |
|-------|-------|-------|-------|-------|
| 1. ก | 2. ข | 3. ก | 4. ข | 5. ค |
| 6. ค | 7. ง | 8. ข | 9. ก | 10. ข |
| 11. ง | 12. ค | 13. ข | 14. ข | 15. ง |

จงขีด ✓ ข้อที่มีน้ำหนักสัมพันธ์กับภาพในช่องแรก

หน้า 74-78

- | | | | | |
|-------|-------|-------|-------|-------|
| 1. ง | 2. ก | 3. ข | 4. ค | 5. ก |
| 6. ข | 7. ง | 8. ค | 9. ก | 10. ง |
| 11. ก | 12. ค | 13. ข | 14. ค | 15. ง |

จงขีด ✓ ข้อที่มีระยะทางยาวเท่ากับภาพในช่องแรก

หน้า 79-83

- | | | | | |
|-------|-------|-------|-------|-------|
| 1. ค | 2. ข | 3. ก | 4. ง | 5. ข |
| 6. ก | 7. ค | 8. ค | 9. ค | 10. ก |
| 11. ก | 12. ค | 13. ก | 14. ค | 15. ข |

จงขีด ✓ ข้อที่มีพื้นที่ว่างเท่ากับภาพแรก

หน้า 84-88

- | | | | | |
|-------|-------|-------|-------|-------|
| 1. ก | 2. ง | 3. ค | 4. ง | 5. ก |
| 6. ข | 7. ค | 8. ง | 9. ก | 10. ข |
| 11. ก | 12. ง | 13. ข | 14. ก | 15. ค |

ตอนที่ 5 ความรู้เรื่องเวลา และนาฬิกา

หน้า 89

จงขีด ✓ ข้อที่นาฬิกาบอกเวลาตามภาพที่กำหนดในช่องแรก

หน้า 90-93

- | | | | | |
|-------|-------|------|------|-------|
| 1. ก | 2. ค | 3. ก | 4. ข | 5. ก |
| 6. ก | 7. ค | 8. ง | 9. ก | 10. ก |
| 11. ข | 12. ค | | | |

