



ข้อสอบ ครั้งที่ 3 ชุดที่ 2

ภาพที่มีระยะทาง หรือความยาว เท่ากันทุกภาพ

|                   |          |          |          |          |
|-------------------|----------|----------|----------|----------|
| <p>1</p> <p>ก</p> | <p>ก</p> | <p>ก</p> | <p>ก</p> | <p>ก</p> |
| <p>2</p> <p>ข</p> | <p>ข</p> | <p>ข</p> | <p>ข</p> | <p>ข</p> |
| <p>3</p> <p>ค</p> | <p>ค</p> | <p>ค</p> | <p>ค</p> | <p>ค</p> |
| <p>4</p> <p>ด</p> | <p>ด</p> | <p>ด</p> | <p>ด</p> | <p>ด</p> |
| <p>5</p> <p>ง</p> | <p>ง</p> | <p>ง</p> | <p>ง</p> | <p>ง</p> |

6

ภาพใดแสดงการรินน้ำจากเหยือกลงแก้วอย่างถูกต้อง

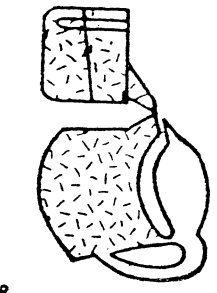
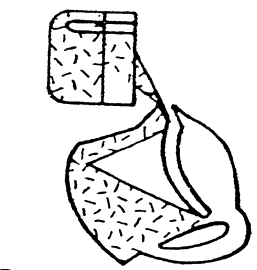
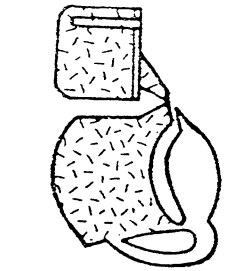
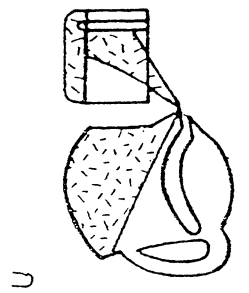
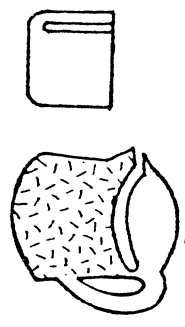

ก

ข

ค

ง

7

น้ำในแก้ว ซู่โตเท่ากับภาพแรก

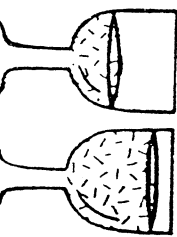
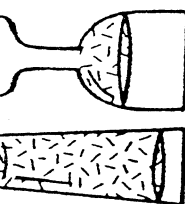
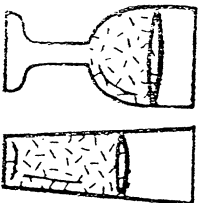
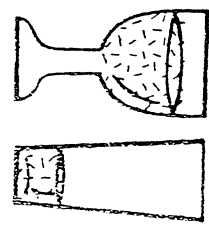
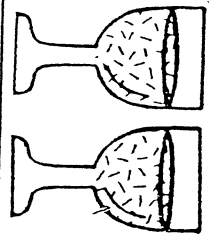

ก

ข

ค

ง

8

น้ำในแก้ว ซู่โตมามีปริมาณเท่ากับภาพแรก

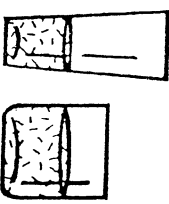
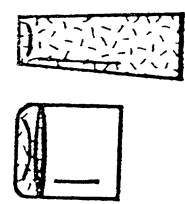
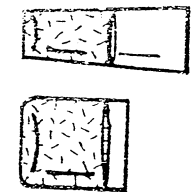
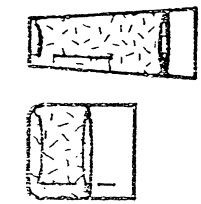
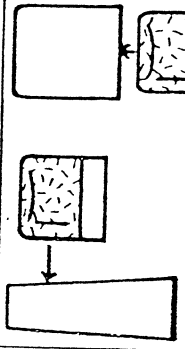

ก

ข

ค

ง

9

เพนซิลวางขณะใด ไม่สิ้น

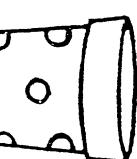
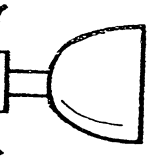
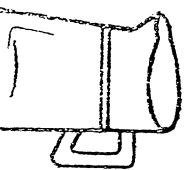
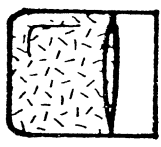

ก

ข

ค

ง

10

น้ำซู่โต เท่ากับภาพแรก

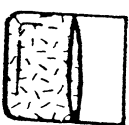
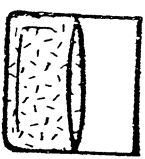
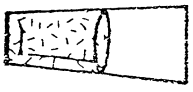
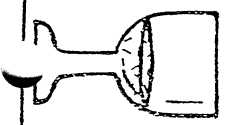
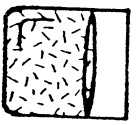

ก

ข

ค

ง

11

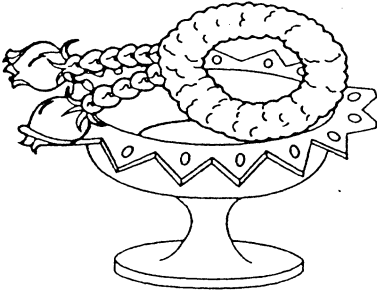
ก 

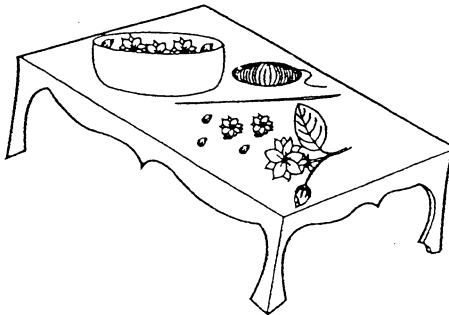
ข 

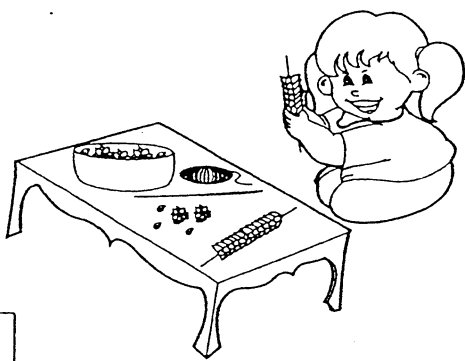
ค 

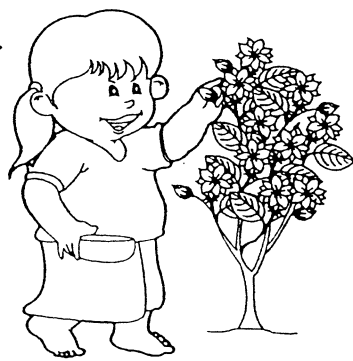
ง 

12

ก 

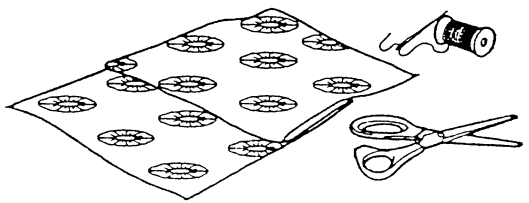
ข 

ค 

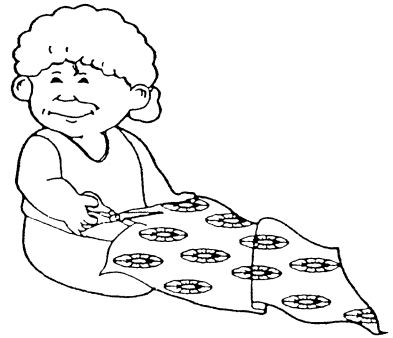
ง 

13

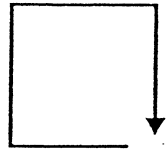
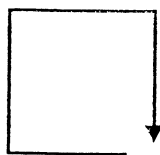
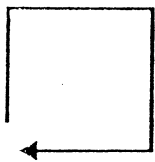
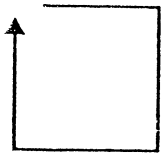

1

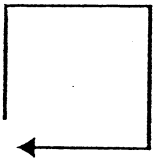

2

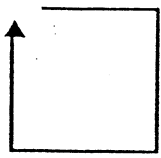

3

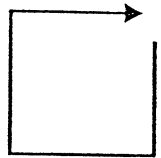

4

14

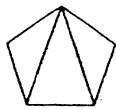
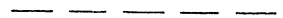
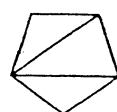
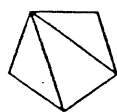
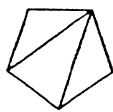
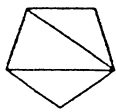

1

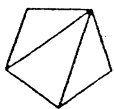

2

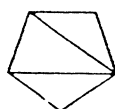

3

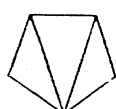

4

15

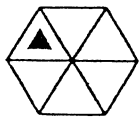
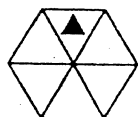

1



2

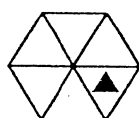

3



4

16.

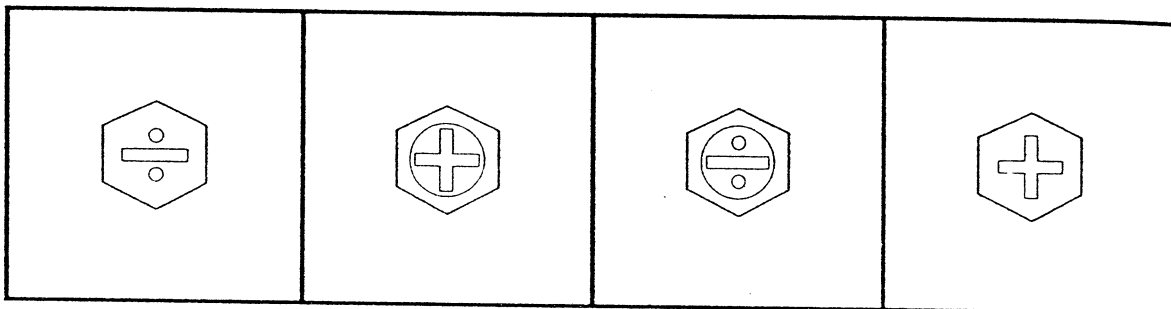
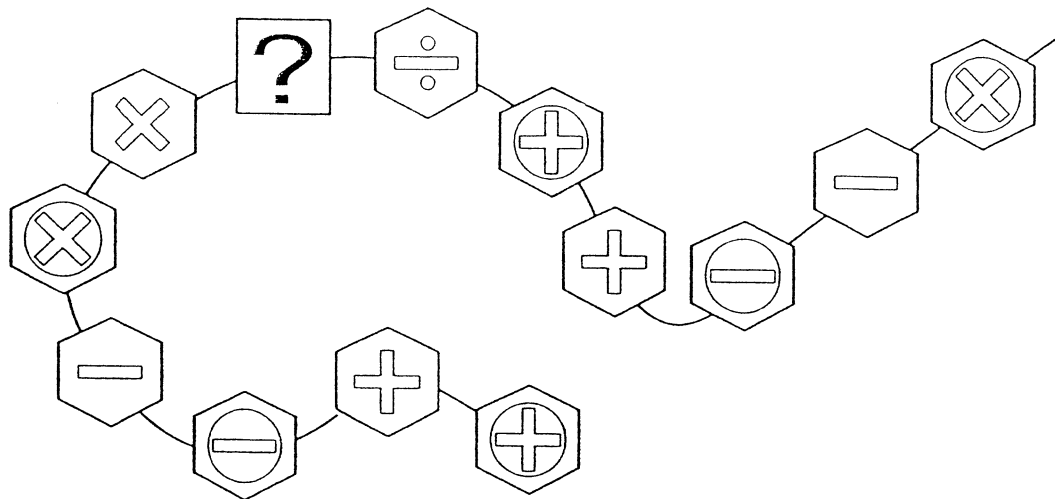

ก

ข

ค

ง

17.

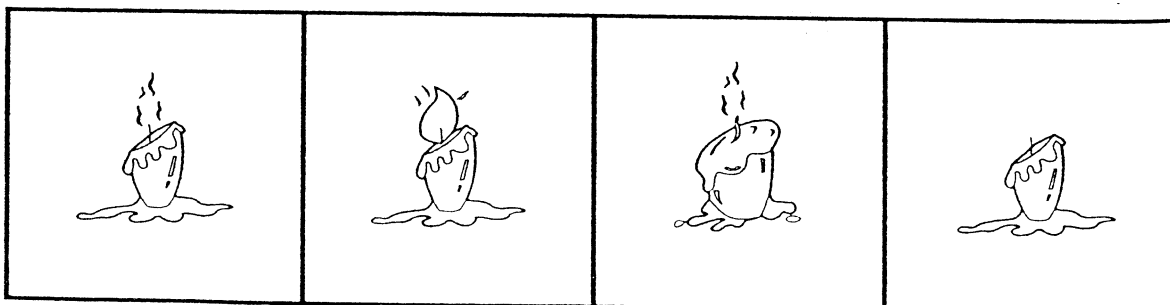
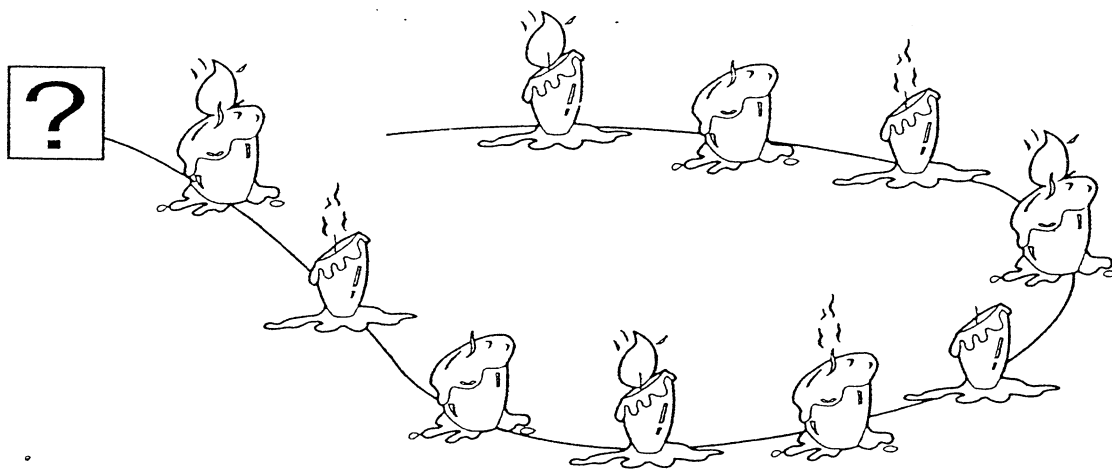

ก

ข

ค

ง

18.

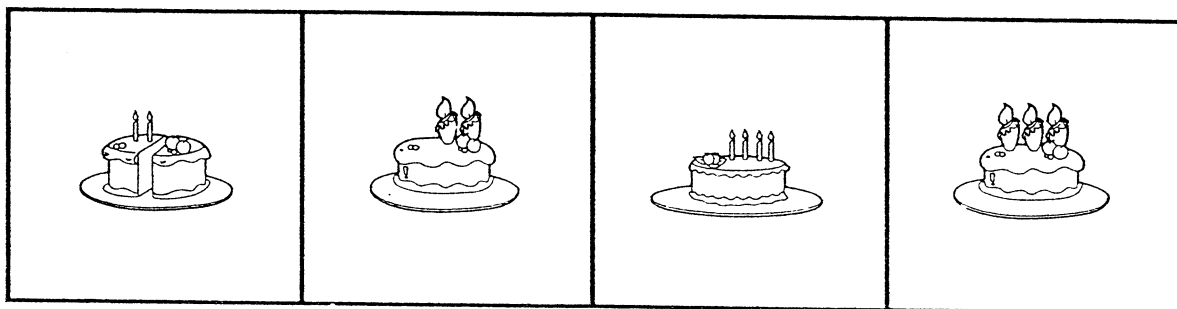
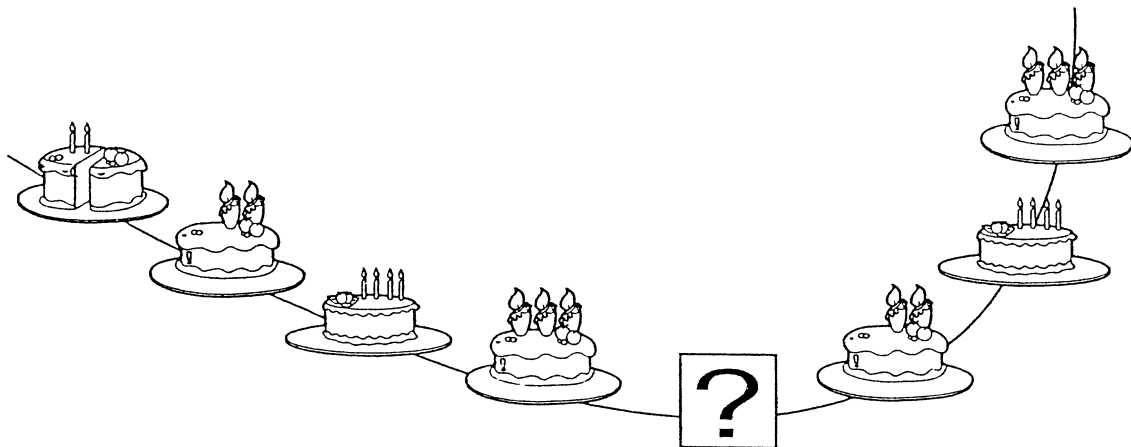

ก

ข

ค

ง

19.

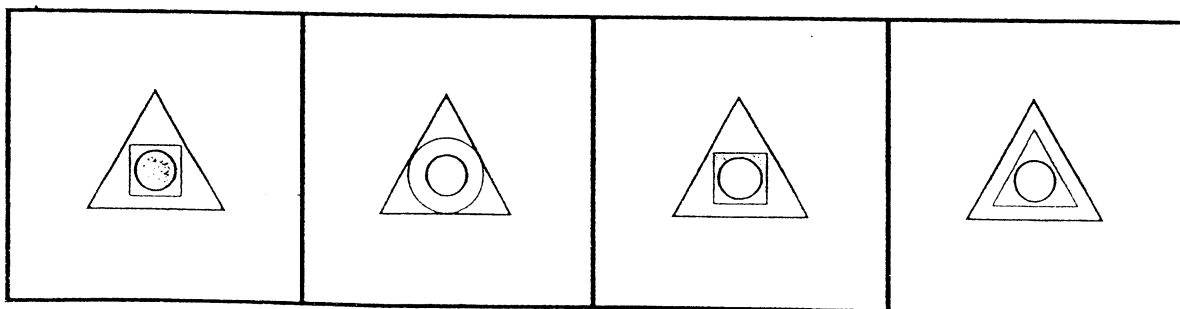
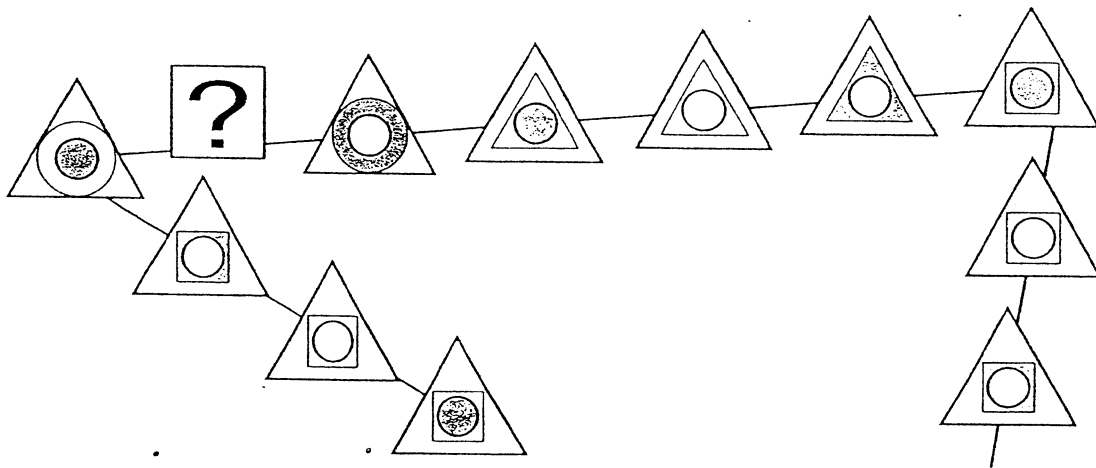

ก

ข

ค

ง

จงขีด / ข้อที่พับแล้วได้กล่องเหมือนภาพในช่องแรก

20

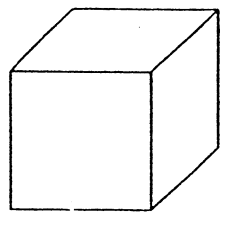
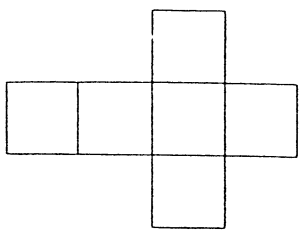
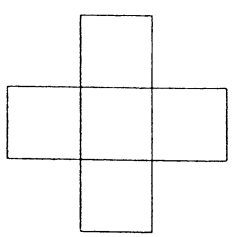
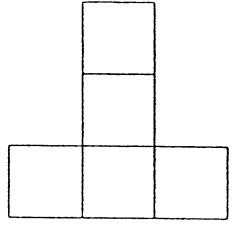
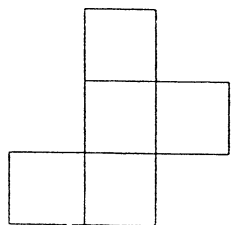
|   |  |  |
|---|--|--|
|  |  <p>ก</p> |  <p>ข</p> |
|   |  <p>ค</p> |  <p>ง</p> |

21

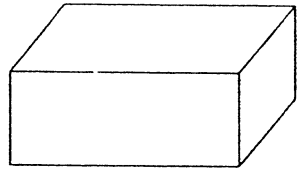
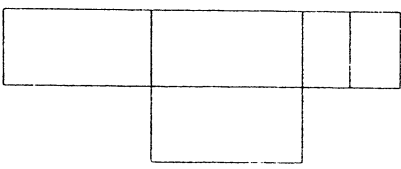
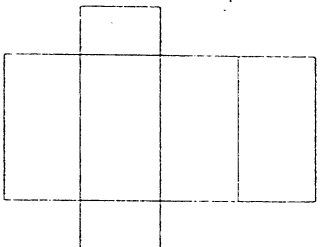
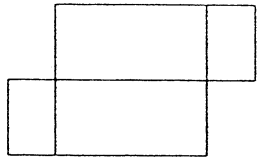
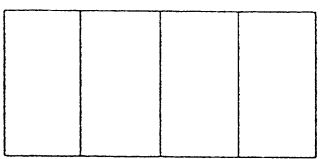
|   |  |  |
|---|--|--|
|  |  <p>ก</p>  |  <p>ข</p>  |
|   |  <p>ค</p> |  <p>ง</p> |

22

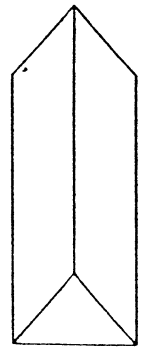
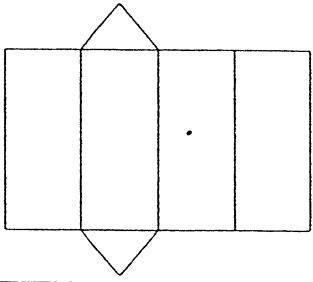
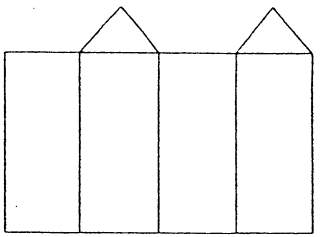
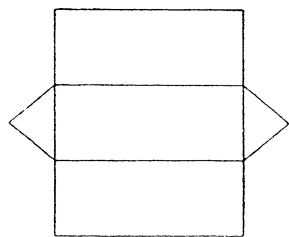
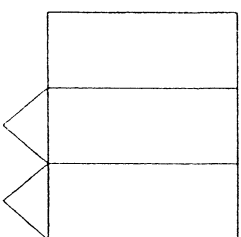
|   |  |  |
|---|--|--|
|  |  <p>ก</p> |  <p>ข</p> |
|   |  <p>ค</p> |  <p>ง</p> |

23

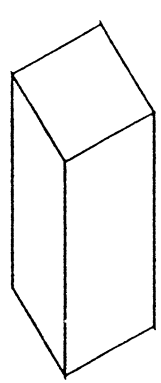

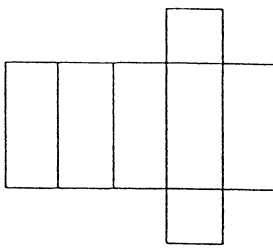
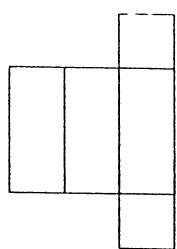
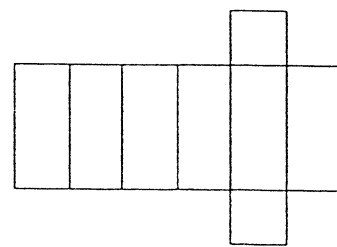
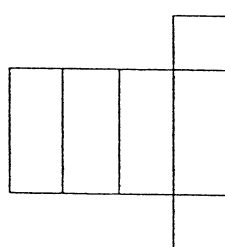
|  |  |
|--|--|
|  <p>ก</p> |  <p>ข</p> |
|  <p>ค</p> |  <p>ง</p> |

24

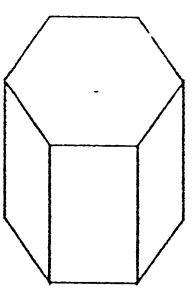

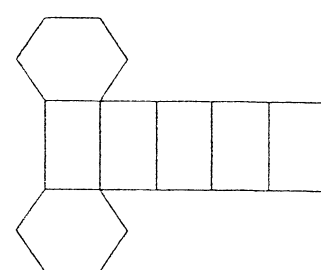
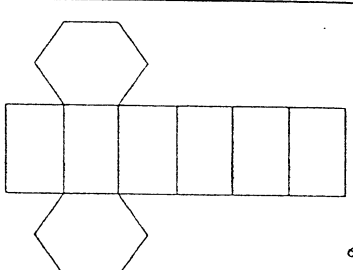
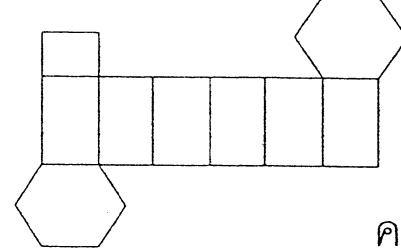
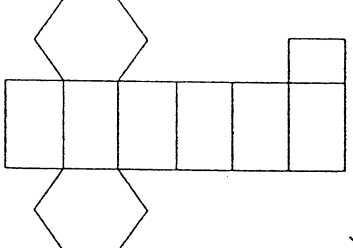
|   |  |
|---|--|
|  <p>ก</p>   |  <p>ข</p>  |
|  <p>ค</p> |  <p>ง</p> |

25

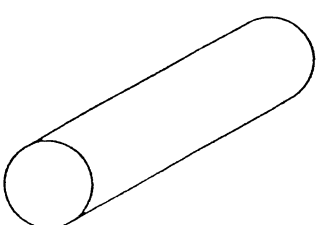

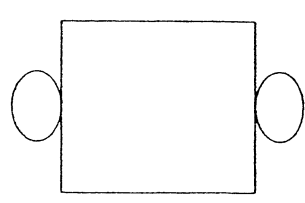
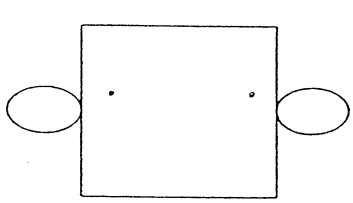
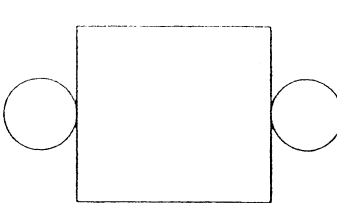
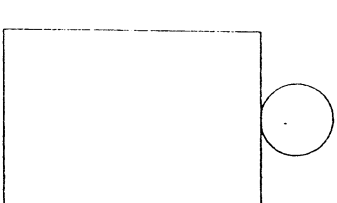
|  |  |
|--|--|
|  <p>ก</p> |  <p>ข</p> |
|  <p>ค</p> |  <p>ง</p> |

26

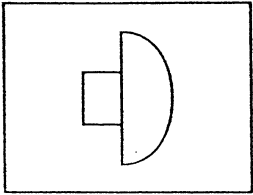
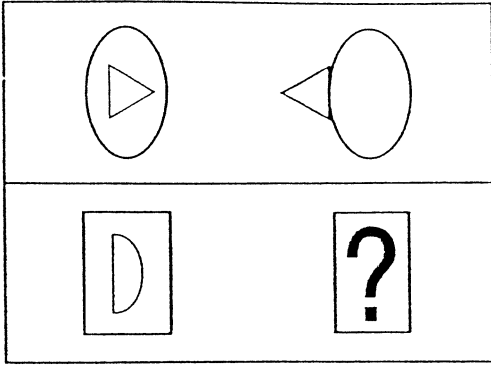

ก

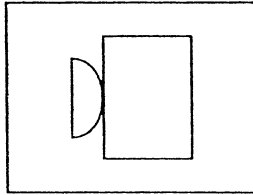

ข

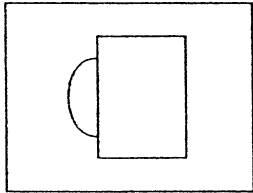

ค

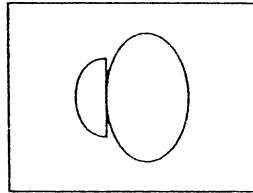

ง

27

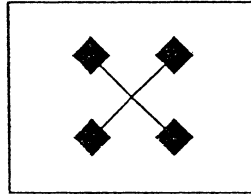
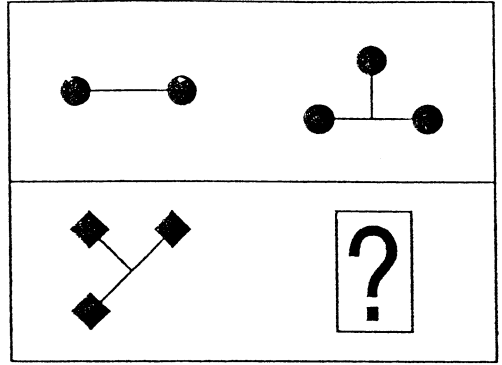

ก

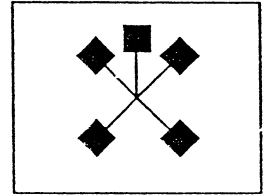

ข

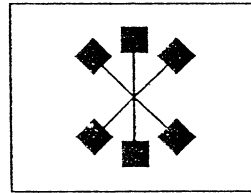

ค

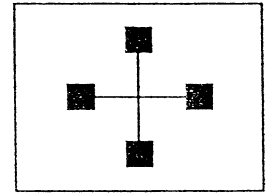

ง

28

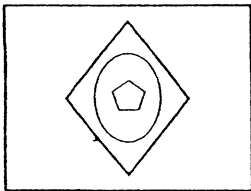

ก

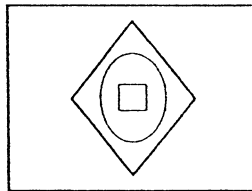

ข

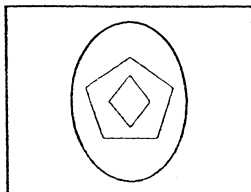

ค

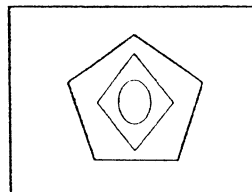

ง

29

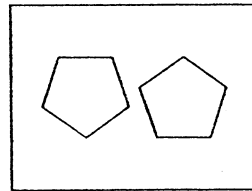
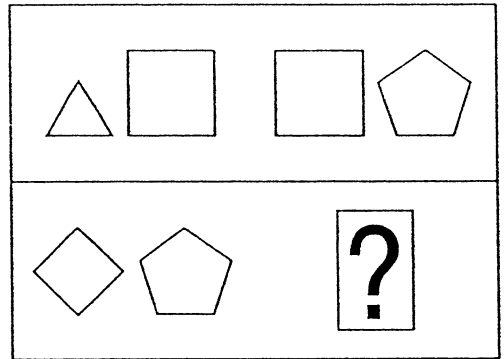

ก

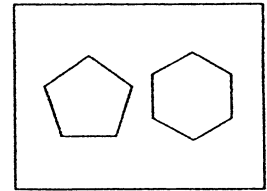

ข

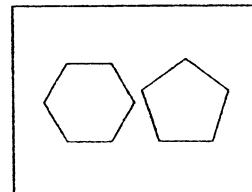

ค

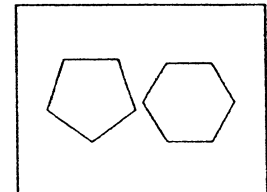

ง

30

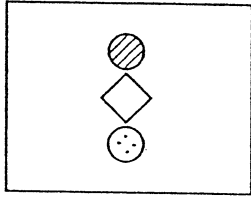
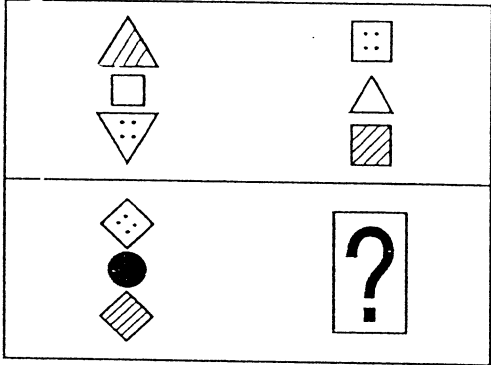

ก

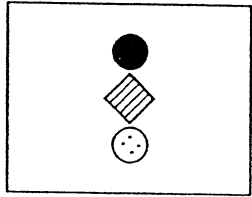

ข

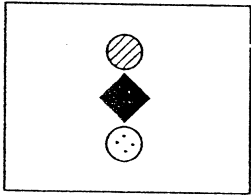

ค

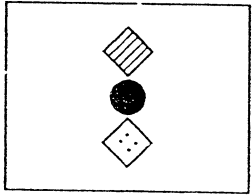

ง

31

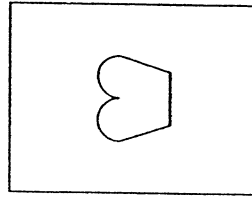
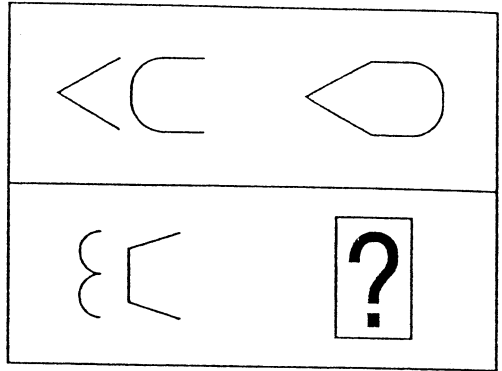

ก

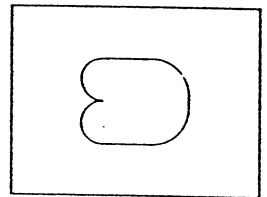

ข

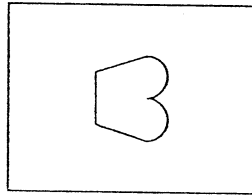

ค

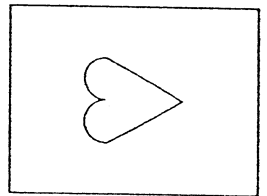

ง

32

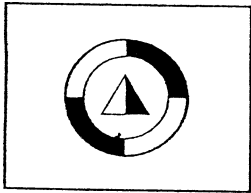
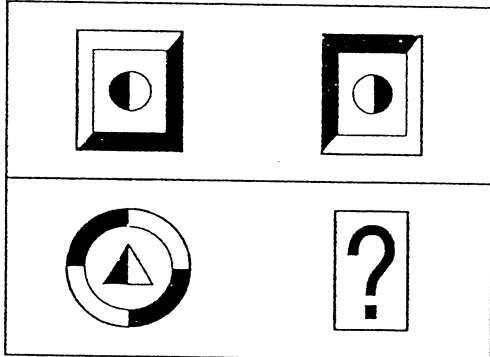

ก

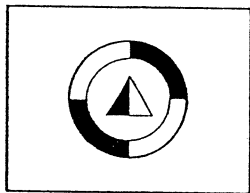

ข

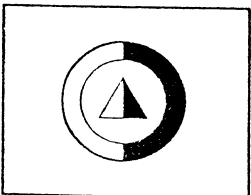

ค

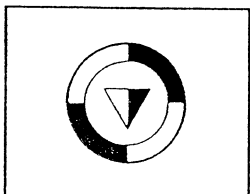

ง

33

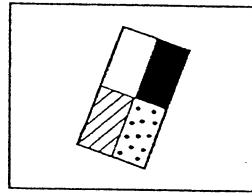
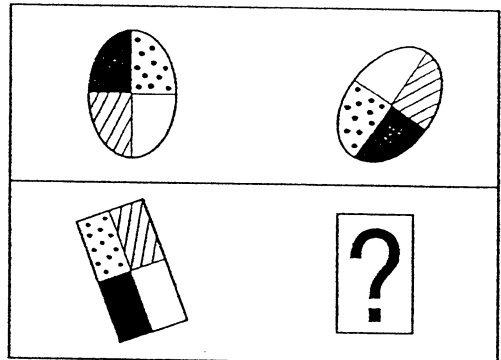

ก

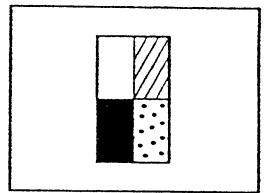

ข

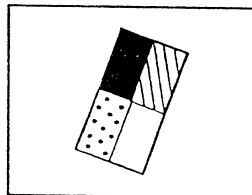

ค

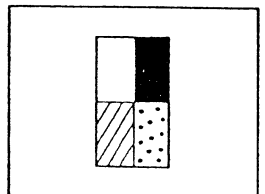

ง