

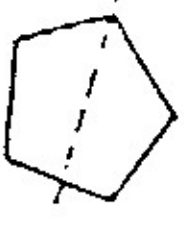













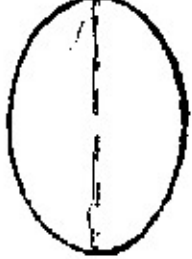

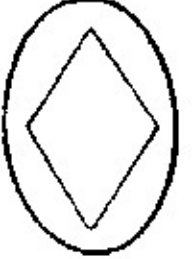

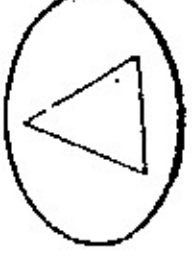
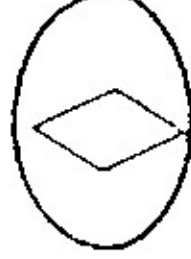
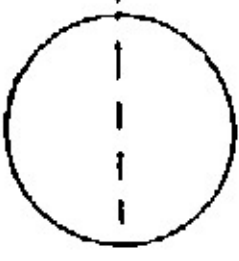

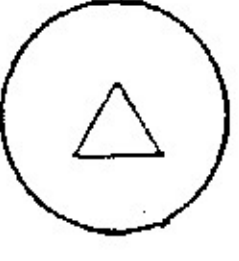

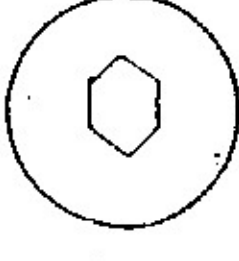
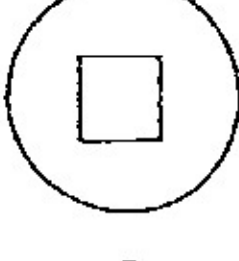
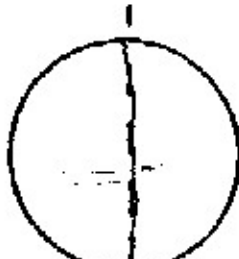

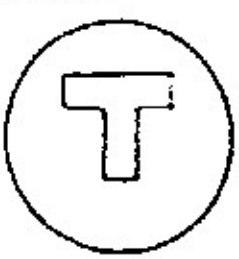



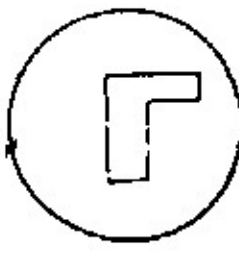
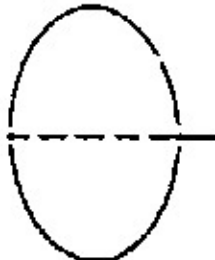

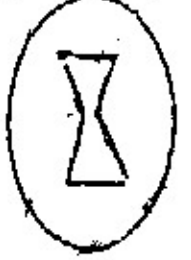
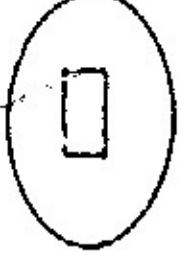

แบบที่ 8 แบบทดสอบภาพตัดกระดาษ

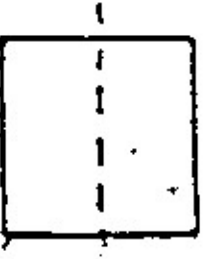
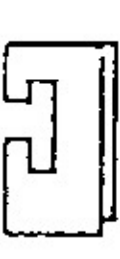
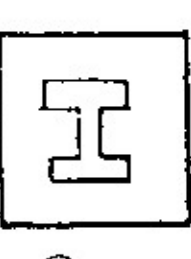
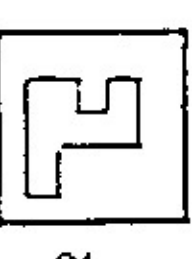
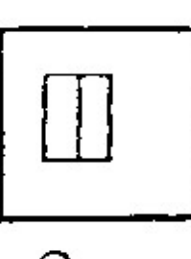

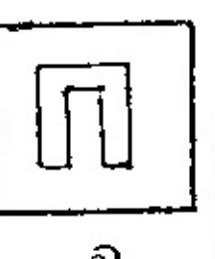
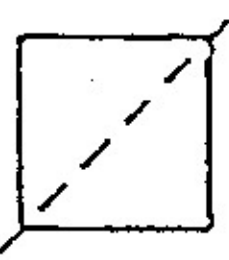

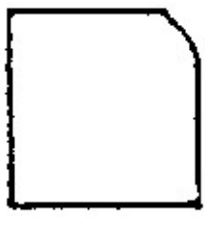

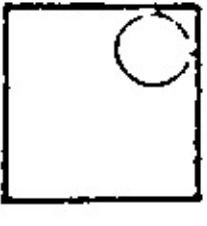
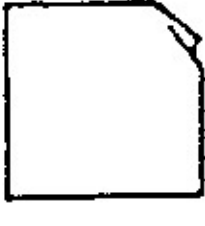



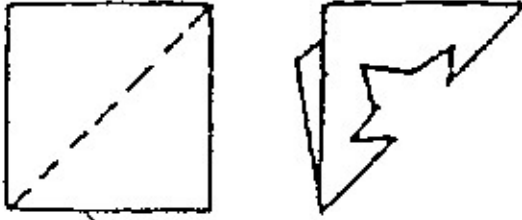

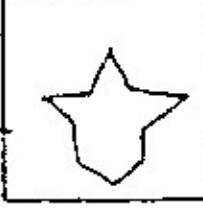

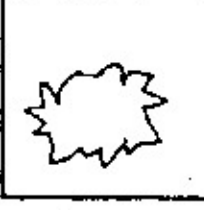
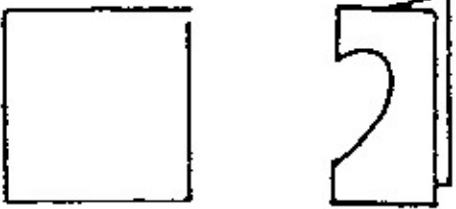

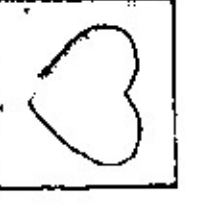



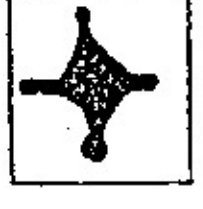

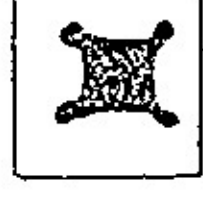

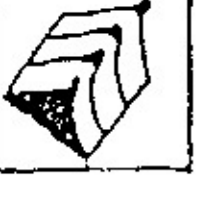
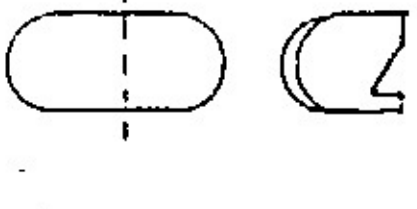



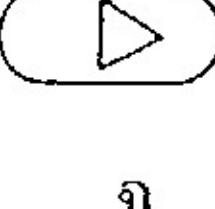

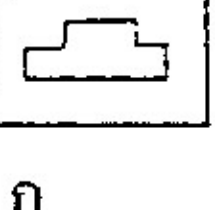
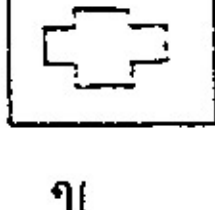
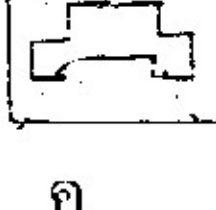
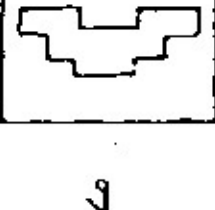
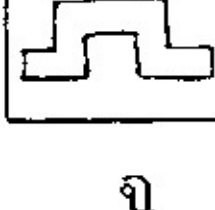
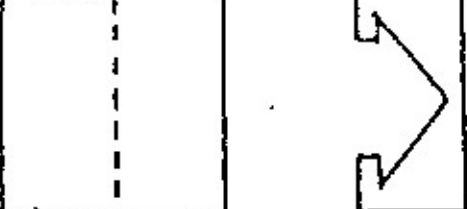
คำชี้แจง ภาพแผ่นทางซ้ายมือนี้ถ้าพับและตัดตามรอย เสร็จแล้วกางแผ่ออกเช่นเดิมจะได้ภาพใด

	<p>ก</p>	<p>ข</p>	<p>ค</p>	<p>ง</p>	<p>จ</p>
	<p>ก</p>	<p>ข</p>	<p>ค</p>	<p>ง</p>	<p>จ</p>
	<p>ก</p>	<p>ข</p>	<p>ค</p>	<p>ง</p>	<p>จ</p>
	<p>ก</p>	<p>ข</p>	<p>ค</p>	<p>ง</p>	<p>จ</p>
	<p>ก</p>	<p>ข</p>	<p>ค</p>	<p>ง</p>	<p>จ</p>
	<p>ก</p>	<p>ข</p>	<p>ค</p>	<p>ง</p>	<p>จ</p>
	<p>ก</p>	<p>ข</p>	<p>ค</p>	<p>ง</p>	<p>จ</p>

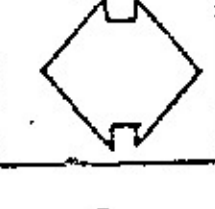
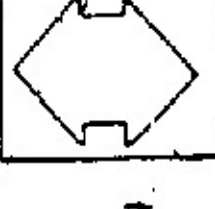
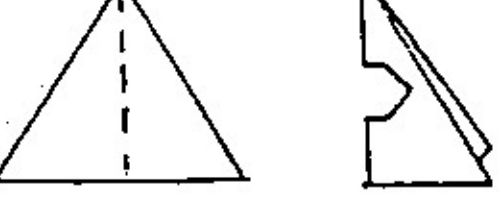
แบบที่ 8 แบบทดสอบภาพตัดกระดาษ

 	     <p>ก ข ค ง จ</p>
 	     <p>ก ข ค ง จ</p>
 	     <p>ก ข ค ง จ</p>
 	     <p>ก ข ค ง จ</p>
 	     <p>ก ข ค ง จ</p>
 	     <p>ก ข ค ง จ</p>
 	     <p>ก ข ค ง จ</p>

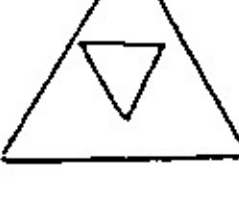
แบบที่ ๘ แบบทดสอบภาพตัดกระดาษ

	     <p>ก ข ค ง จ</p>
	     <p>ก ข ค ง จ</p>
	     <p>ก ข ค ง จ</p>
	     <p>ก ข ค ง จ</p>
	     <p>ก ข ค ง จ</p>
	     <p>ก ข ค ง จ</p>
	     <p>ก ข ค ง จ</p>

ตัวอย่าง รูปไหนด้อยที่หมายถึง ร้านตัดผม

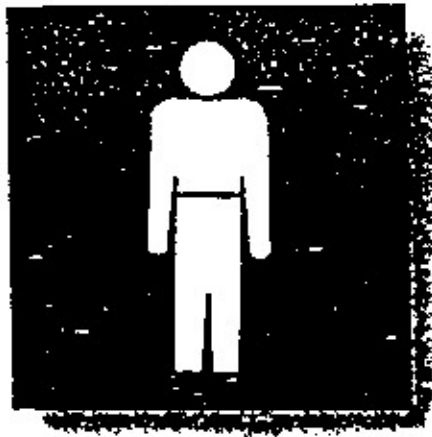

ตัวอย่าง รูปไหนด้อยที่หมายถึง การแข่งขันพายเรือ

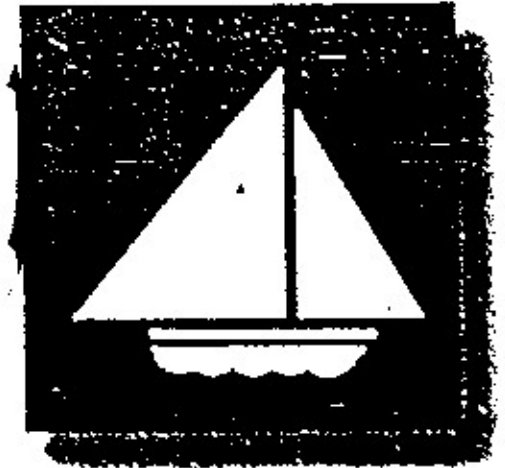
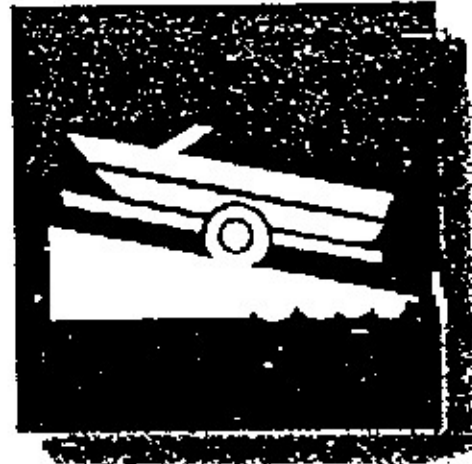

๑. รูปไหนด้อยที่หมายถึง

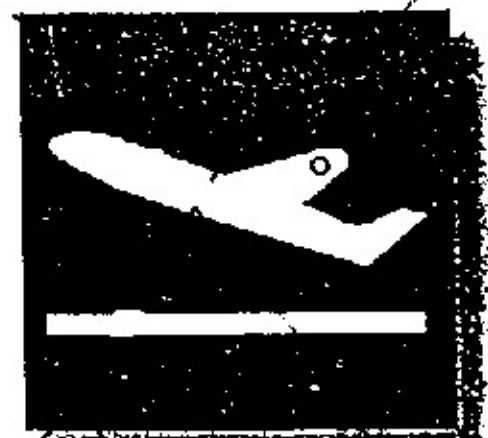
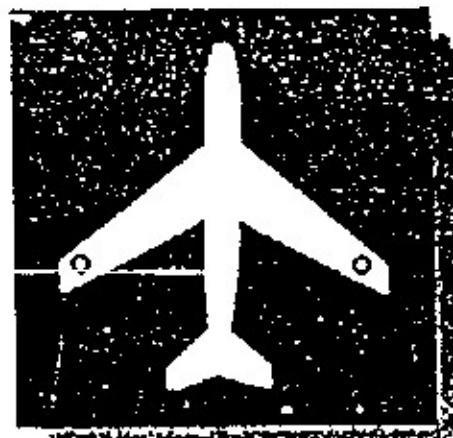

๒. รูปไหนด้อยที่หมายถึง

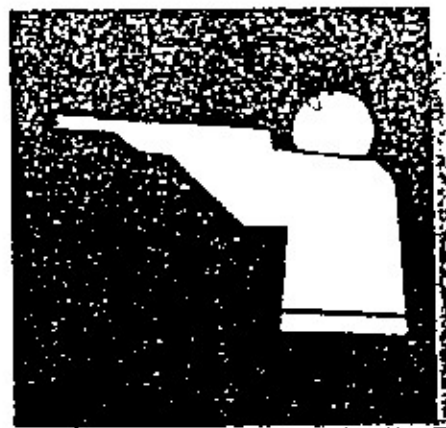
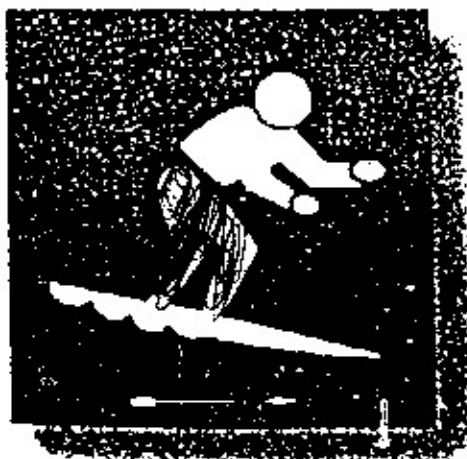

๓. รูปไหนเอ๋ยที่หมายถึง



๔. รูปไหนเอ๋ยที่หมายถึง

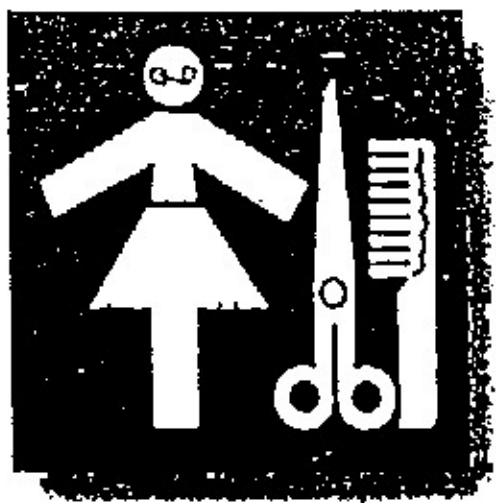

๕. รูปไหนเอ๋ยที่หมายถึง



๖. รูปไหนเอ๋ยที่หมายถึง

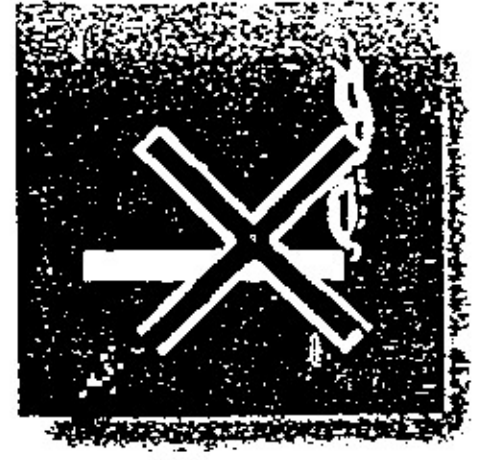

๗. รูปไหนเอ๋ยที่หมายถึง

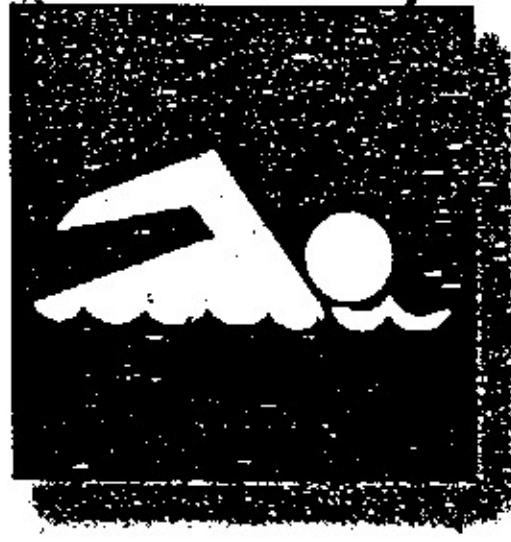

๘. รูปไหนเอ๋ยที่หมายถึง



๙. รูปไหนเอ๋ยที่หมายถึง

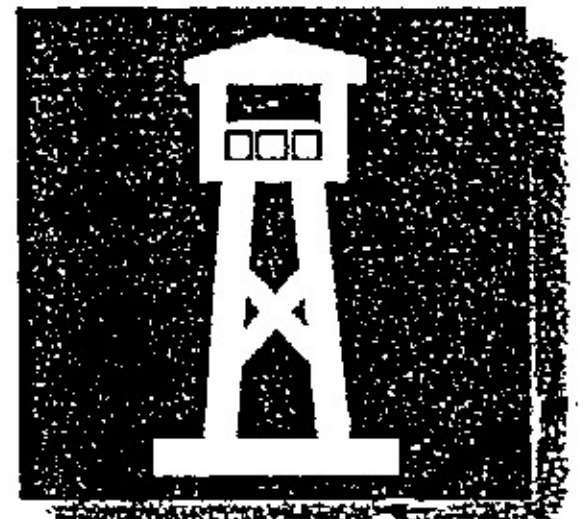
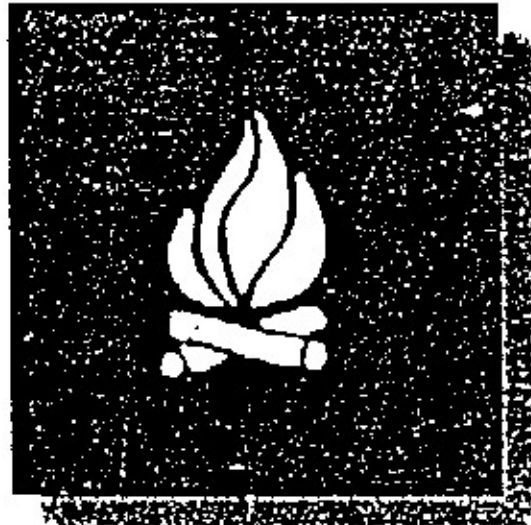
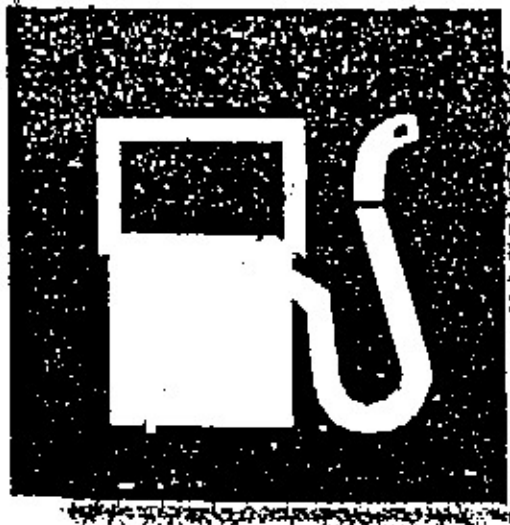

๑๐. รูปไหนเอ๋ยที่หมายถึง

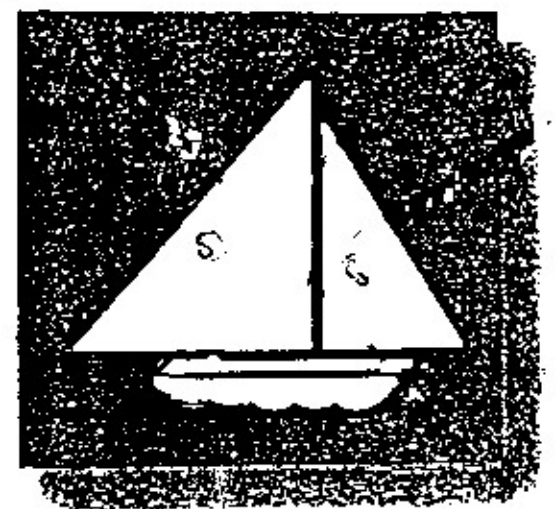
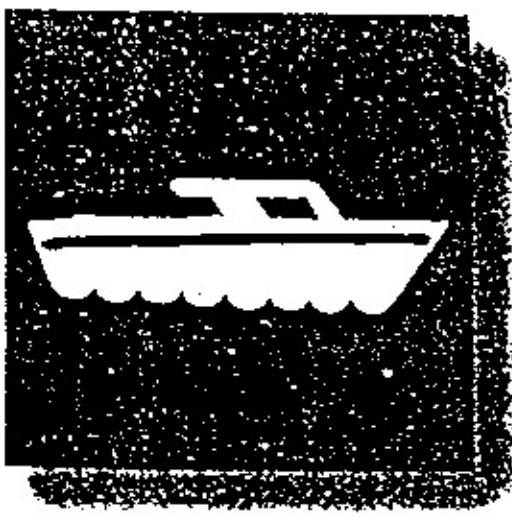

จง X กับภาพที่เล็กกว่าภาพที่กำหนดให้

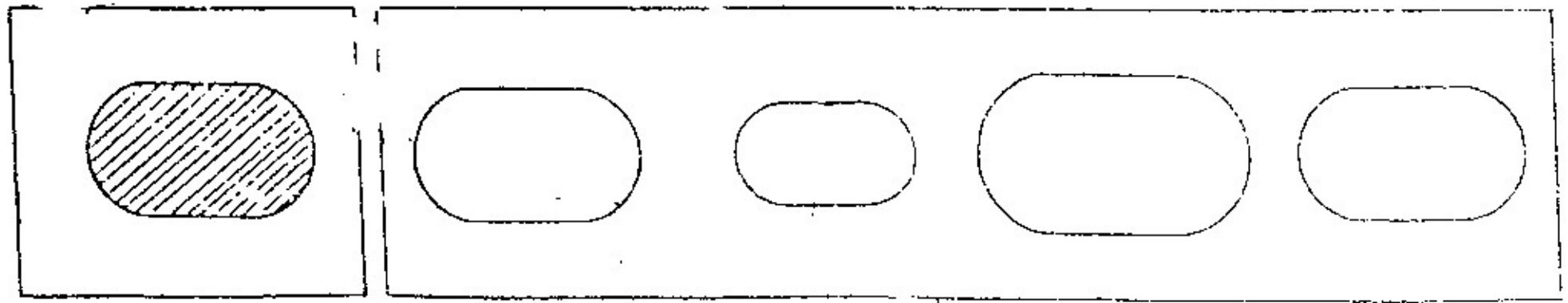
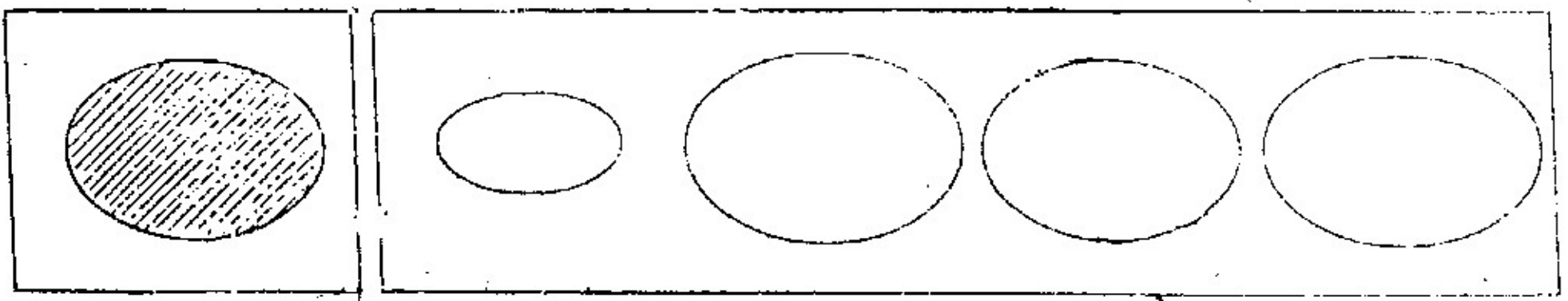
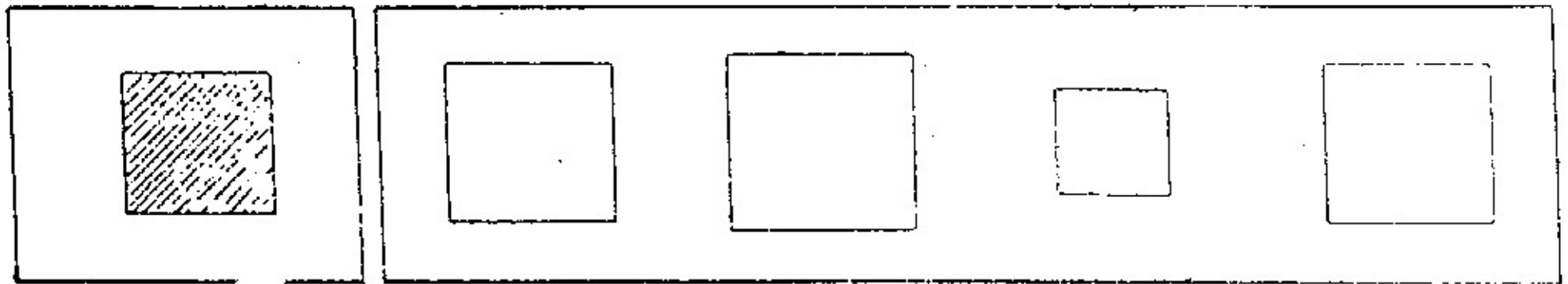
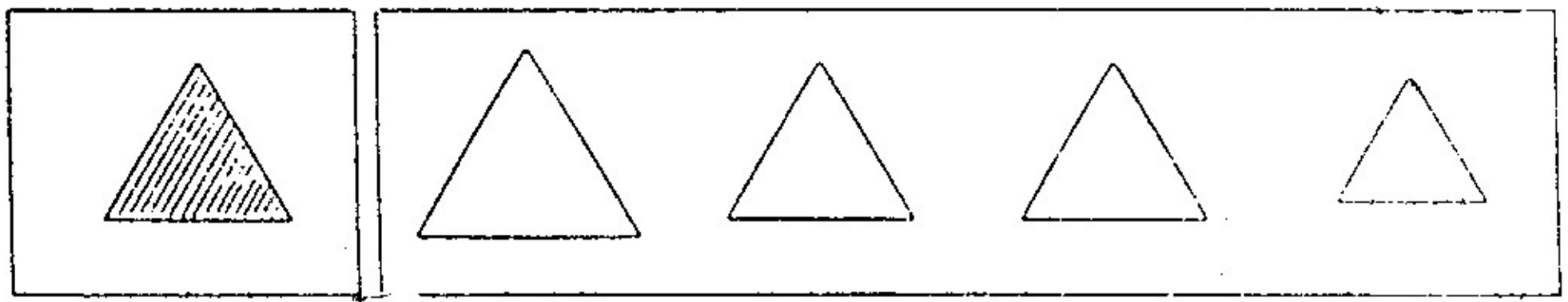
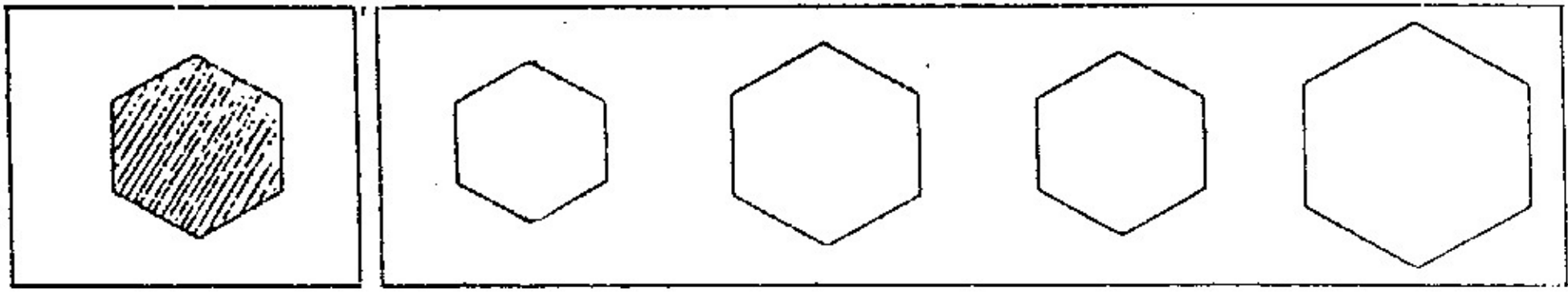
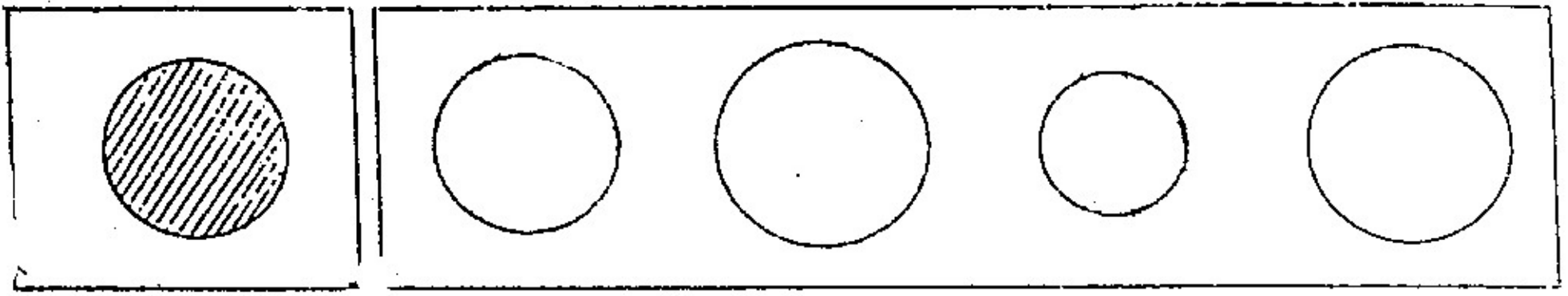

จง × ำปภาพำเเตกต่างจากภำพอื่น

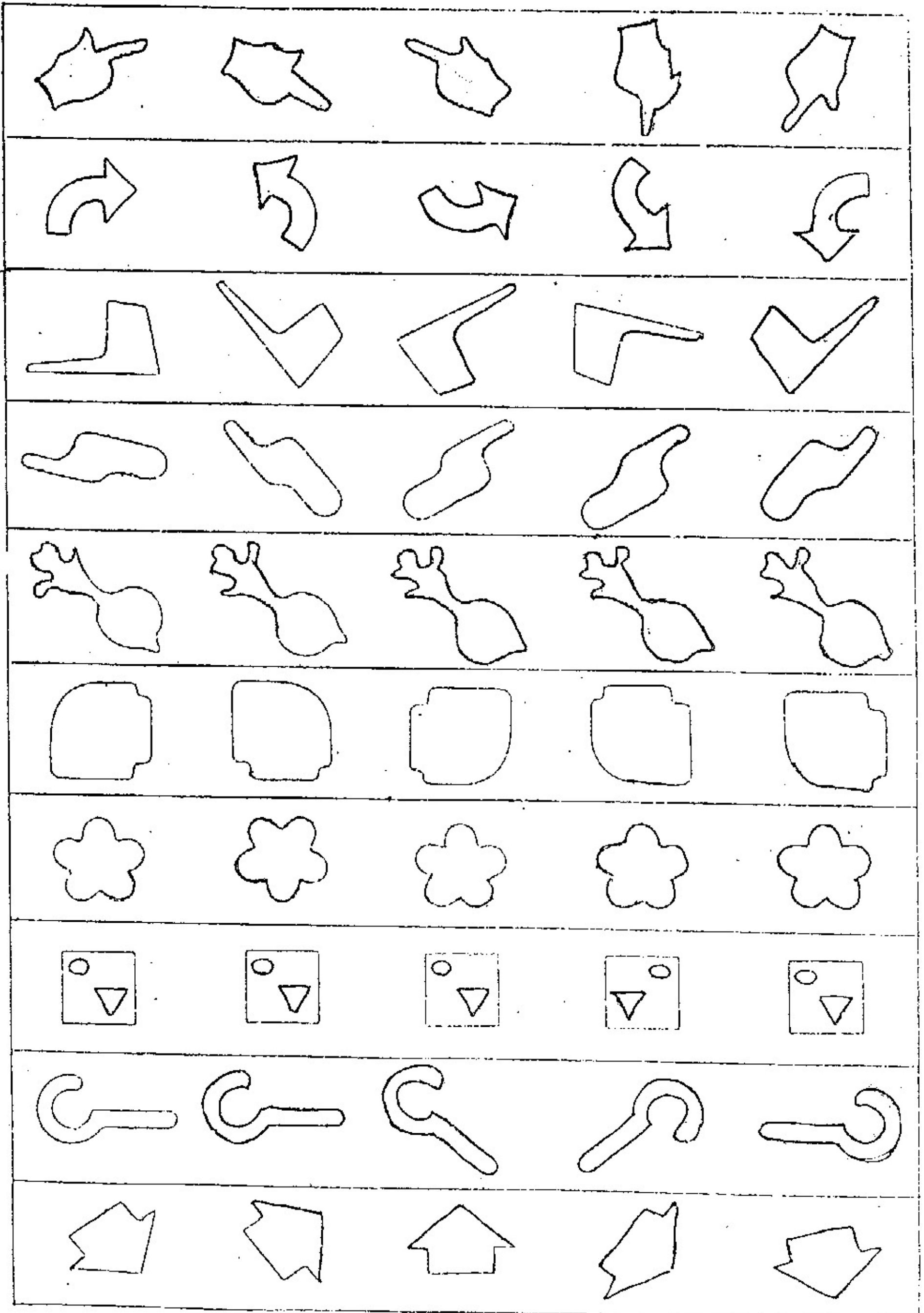

ความพ้อง อ.3

ความพ้องของตัว 1 ของ อักษรพ้อง

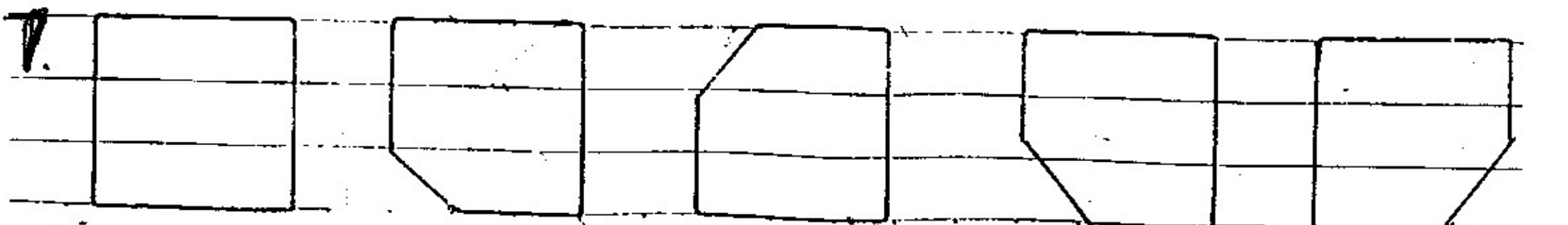
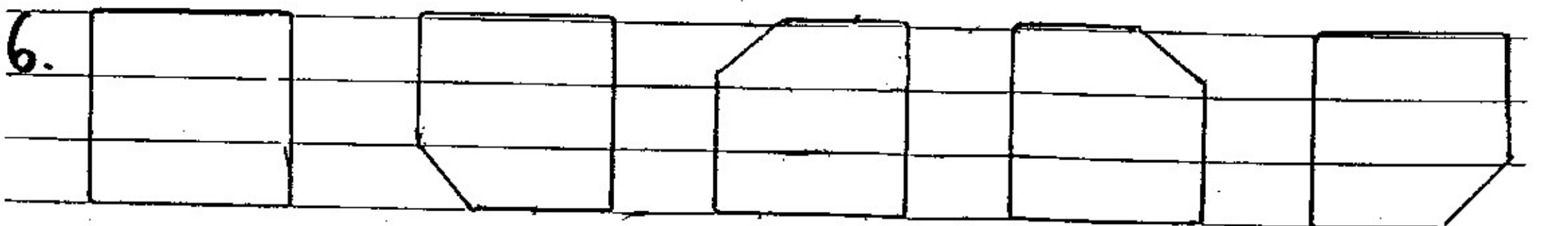
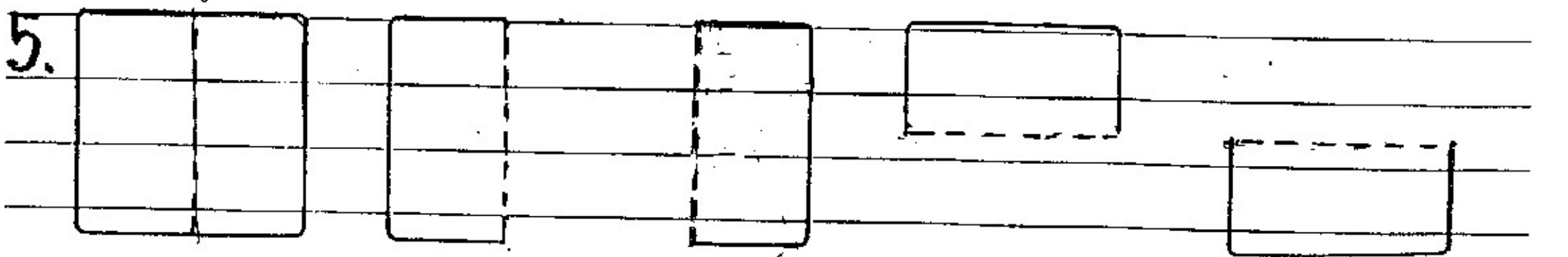
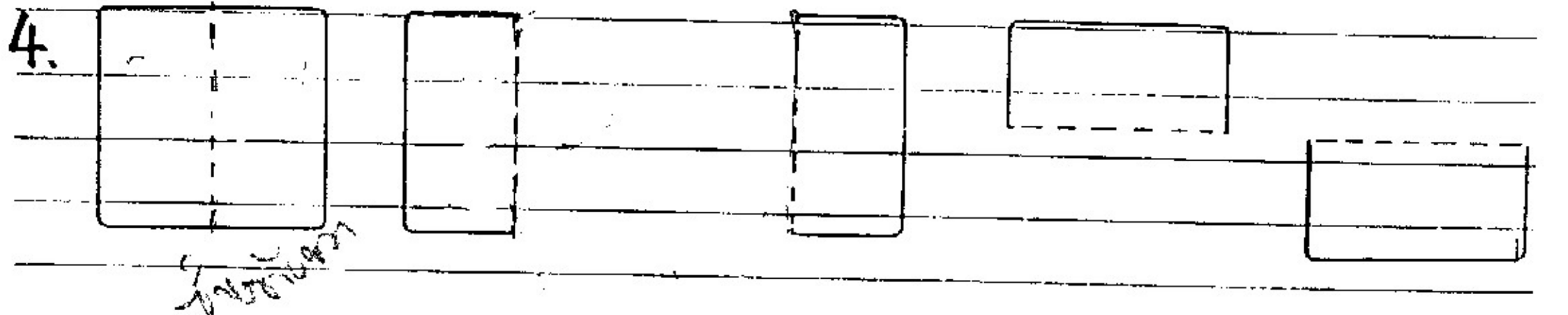
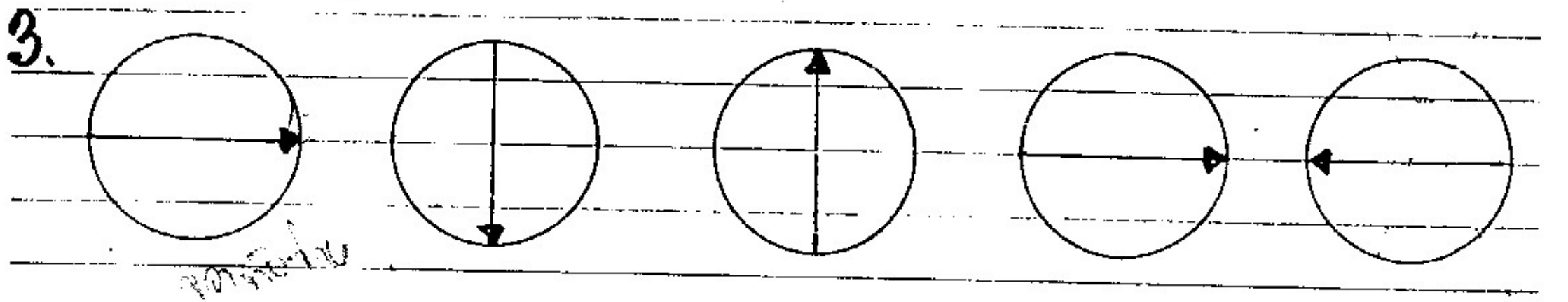
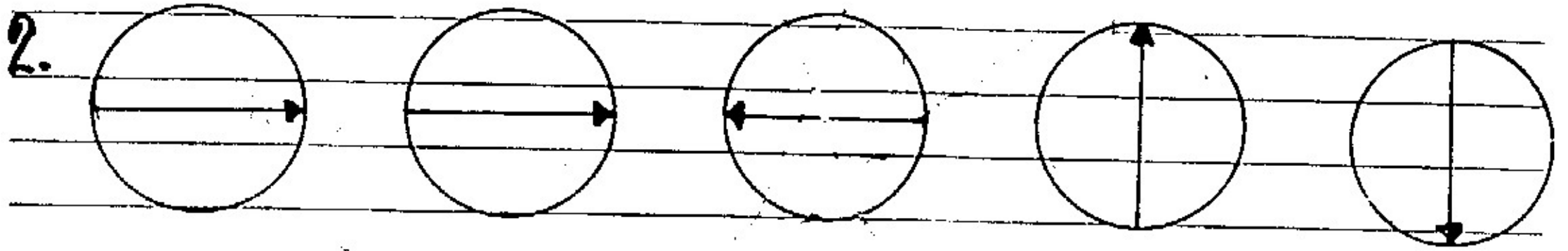
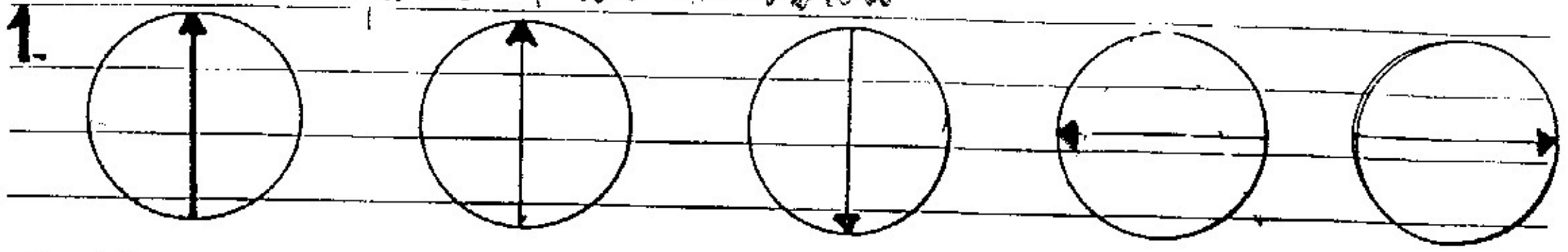

8

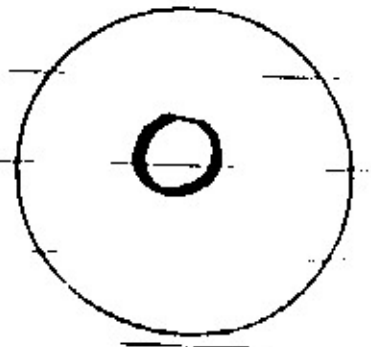
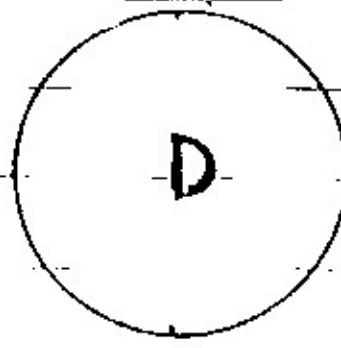
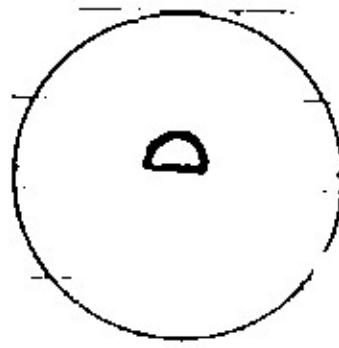
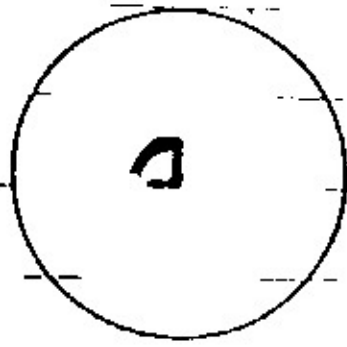

9.

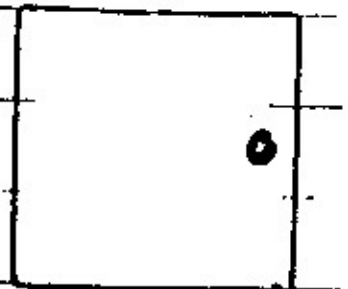
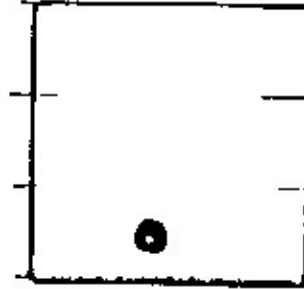
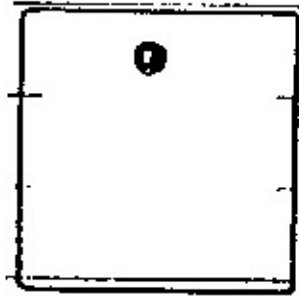
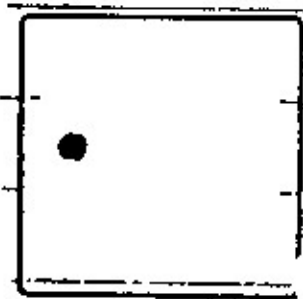
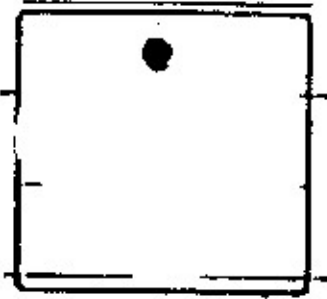

10.

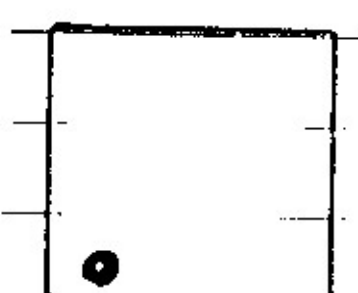
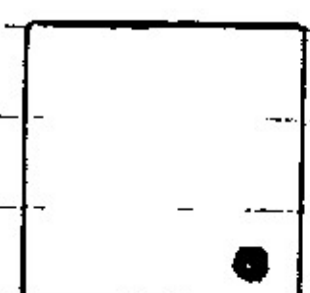
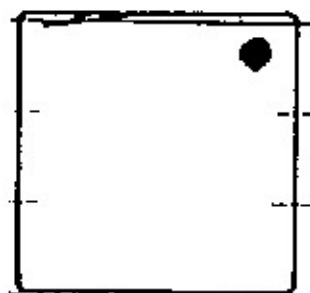
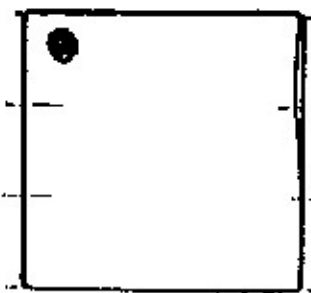
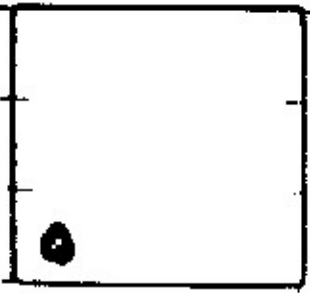

11.

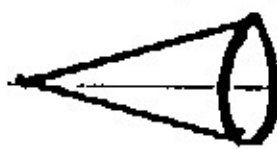

12.

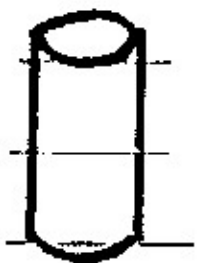
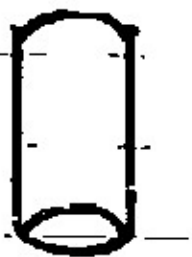

13.

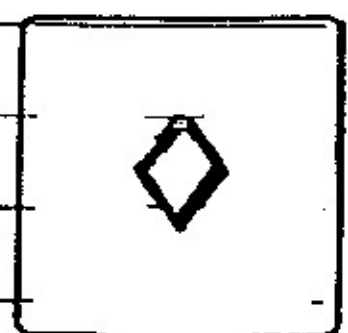
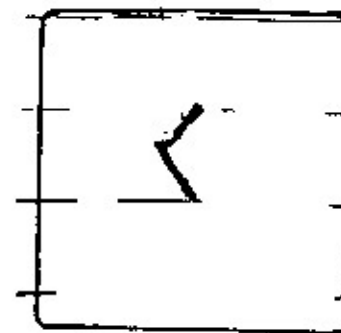
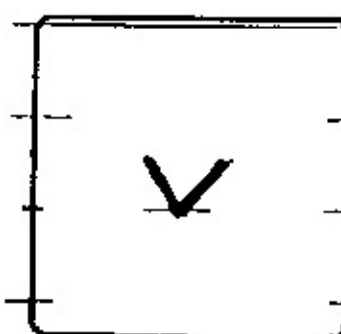
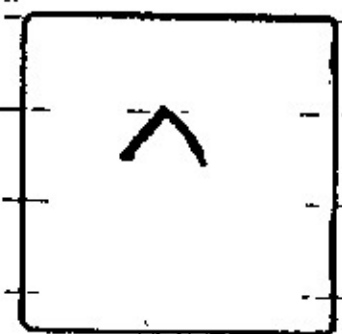
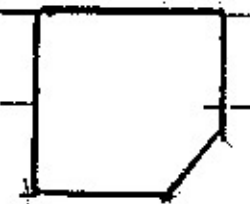

14.

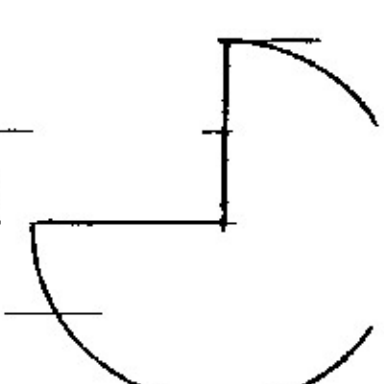
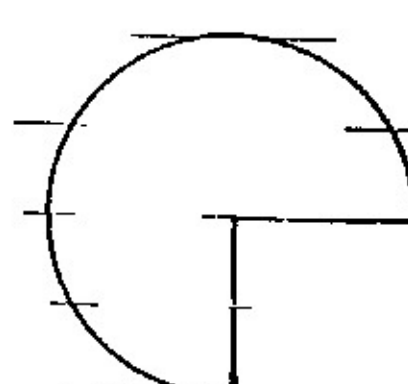
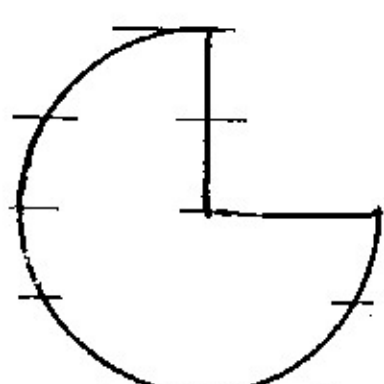
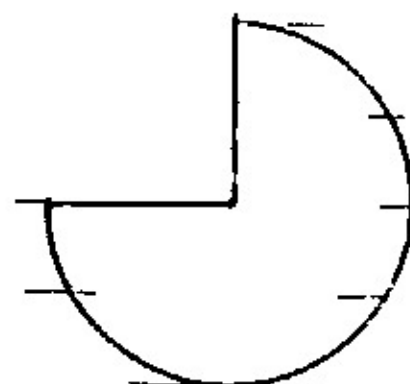
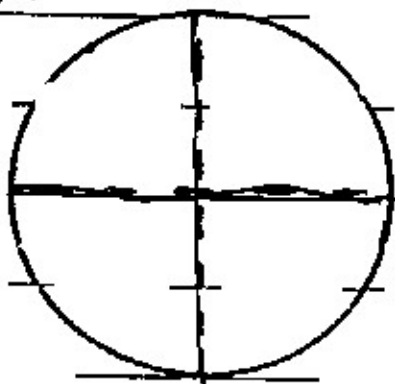

15.

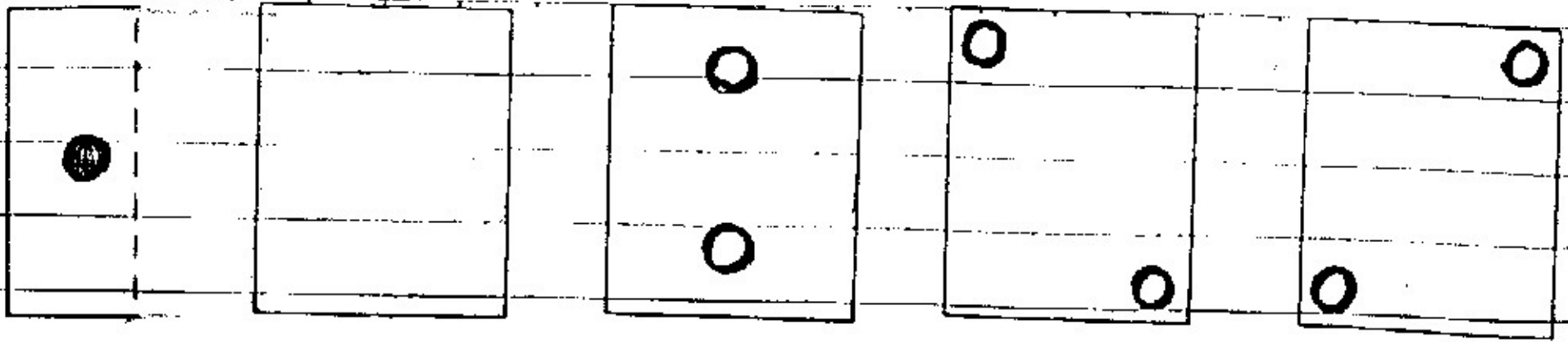

การขยำ

คำสั่ง เริ่มคำจากขยำ

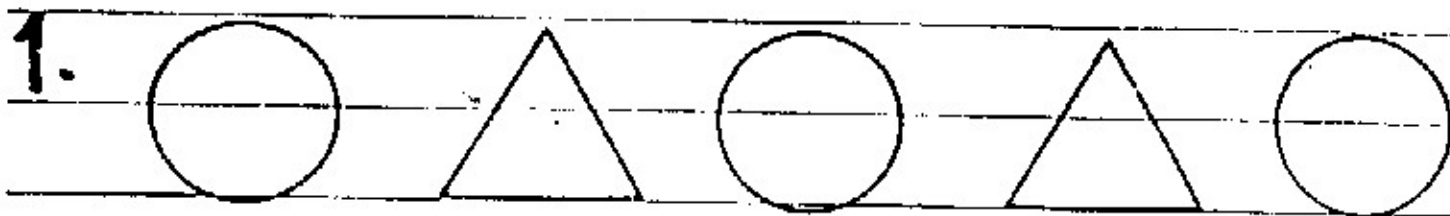

3. เริ่มจุดรูปสี่เหลี่ยม

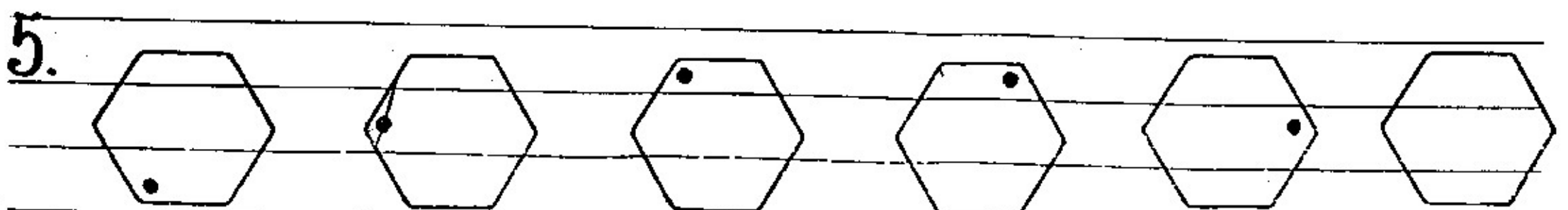
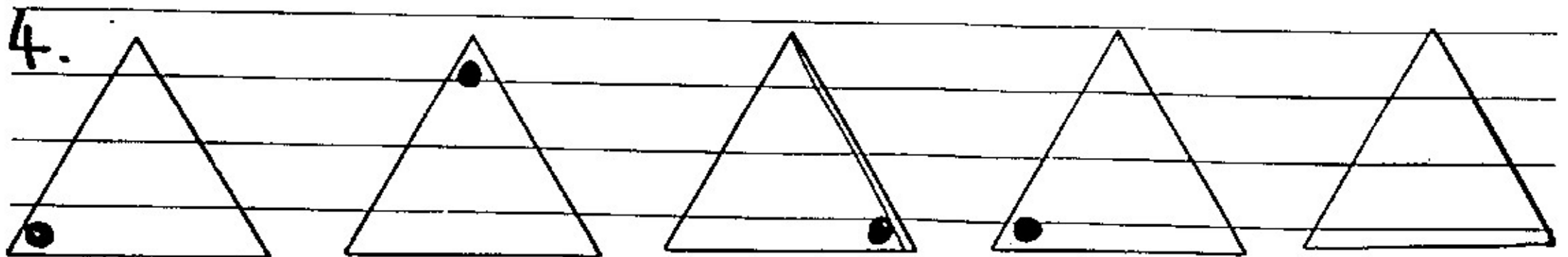
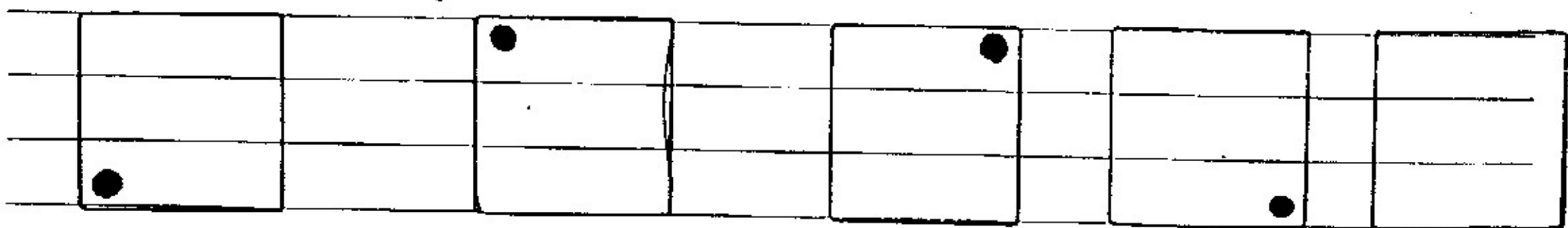

ကိန်း ၇၇ X နံပါတ်စာရင်းကိန်းစာရင်း

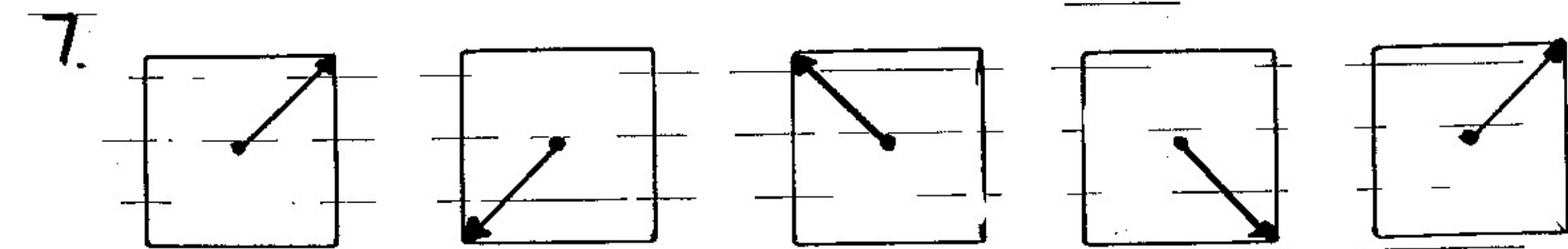
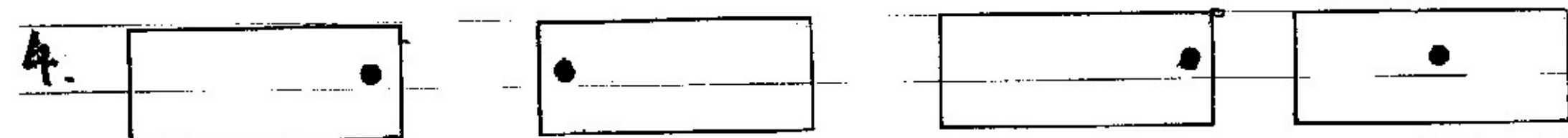
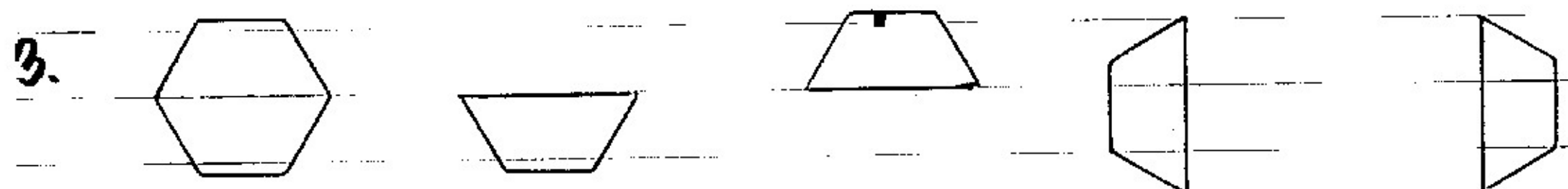
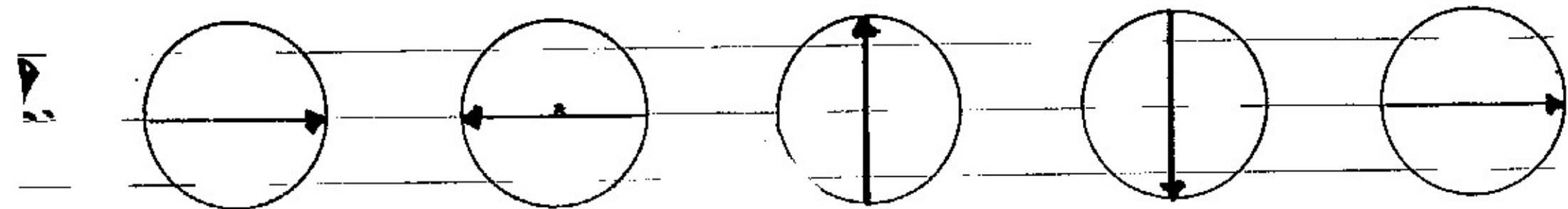
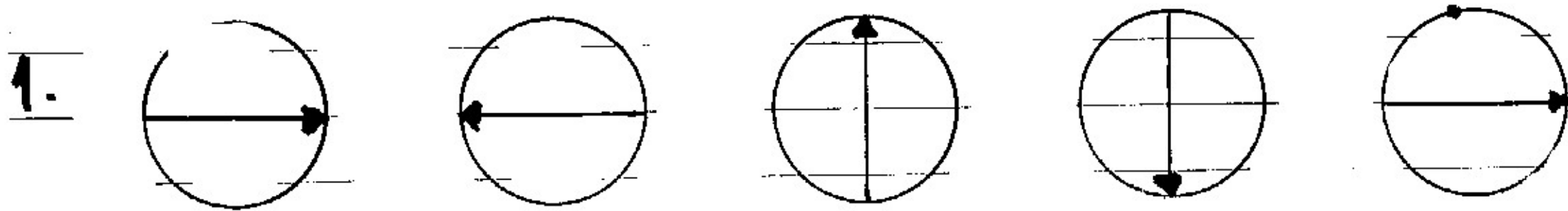

8.

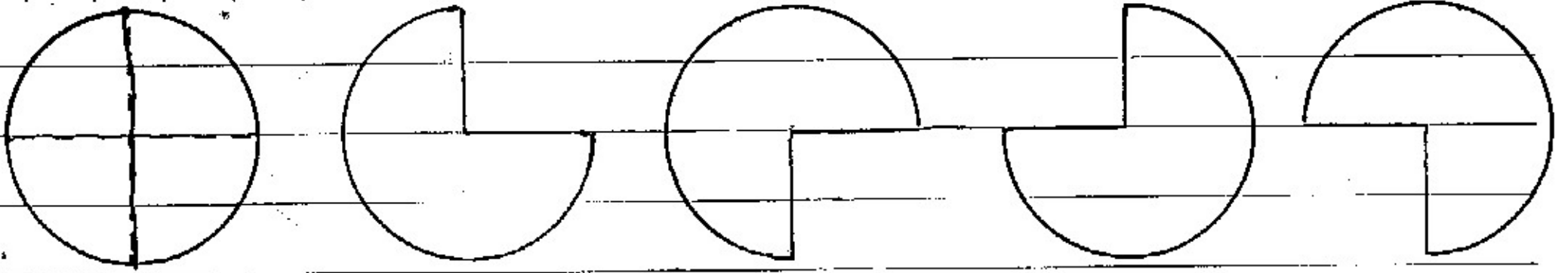

9.

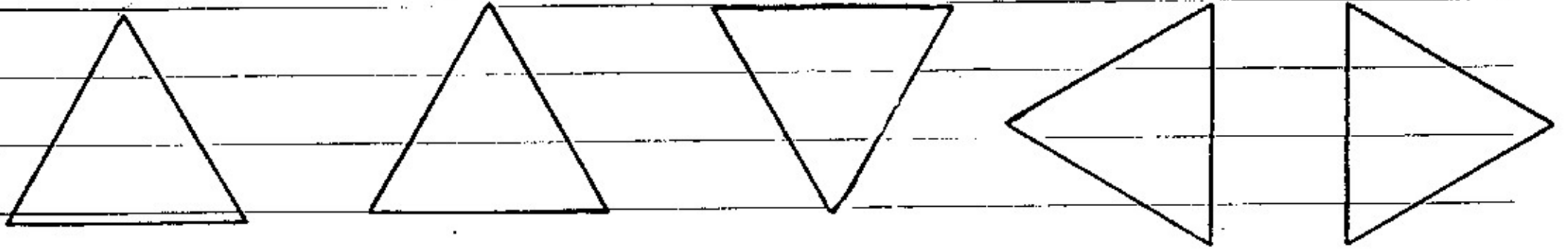

10.

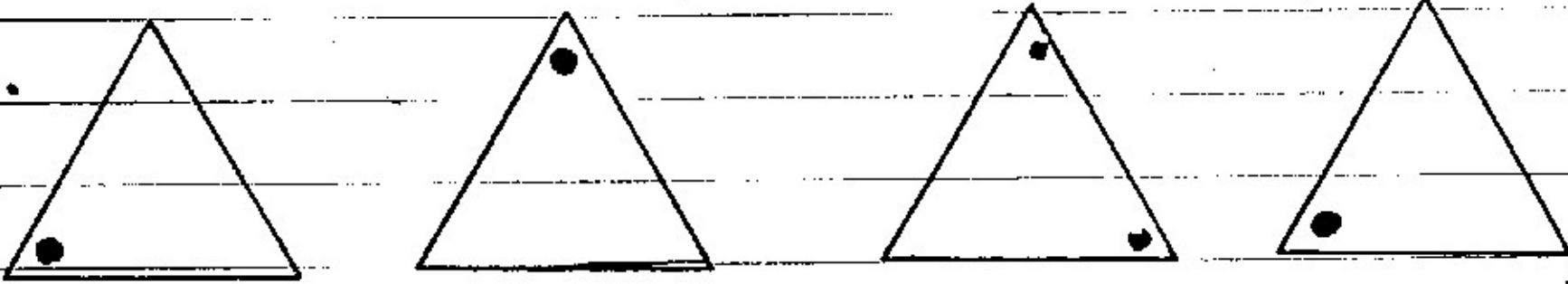

11.



12.

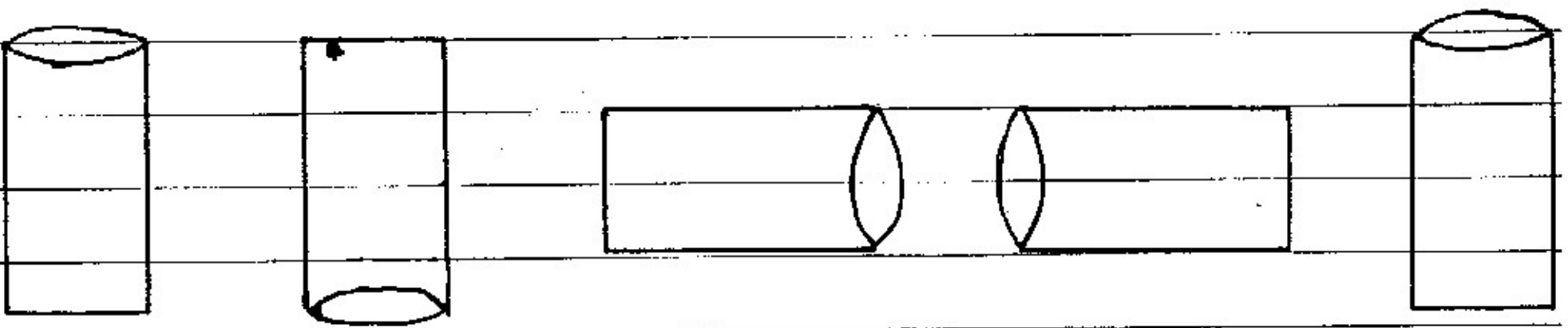

ต่อไปนี้เป็นข้อสอบจริง ๆ ในแบบที่ 1 จับคู่กัน ขอให้ตั้งใจทำ และนี่ให้ดีกว่าของที่อยู่กันนั้น
จะเป็นอะไร เริ่มจับเวลาทันทีที่ลงมือทำ

(ใช้เวลา 7 นาที)

1	<div data-bbox="961 647 1306 949" data-label="Image"></div> <div data-bbox="567 1142 787 1335" data-label="Image"></div> <div data-bbox="976 1142 1102 1335" data-label="Image"></div> <div data-bbox="1291 1142 1459 1335" data-label="Image"></div> <div data-bbox="1669 1113 1858 1335" data-label="Image"></div>
2	<div data-bbox="949 1608 1293 1952" data-label="Image"></div> <div data-bbox="609 2003 703 2329" data-label="Image"></div> <div data-bbox="913 2107 1123 2329" data-label="Image"></div> <div data-bbox="1270 2151 1470 2329" data-label="Image"></div> <div data-bbox="1627 2033 1848 2329" data-label="Image"></div>

3

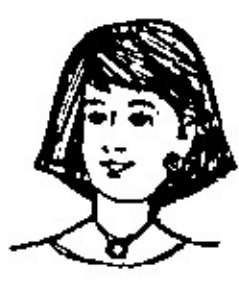
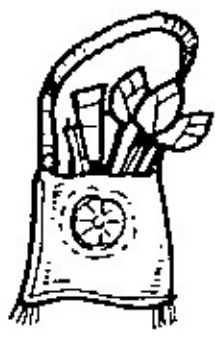
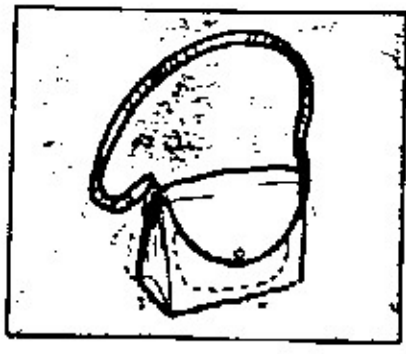

4

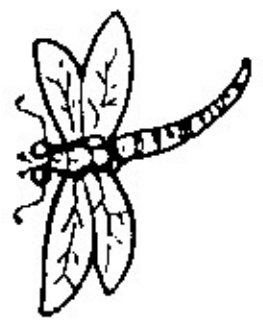

5

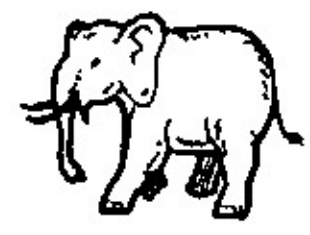
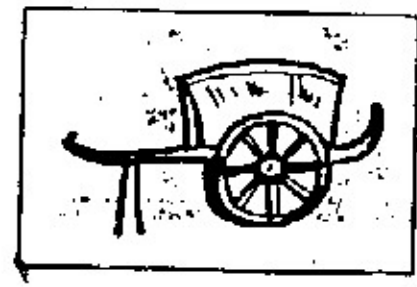

6



7

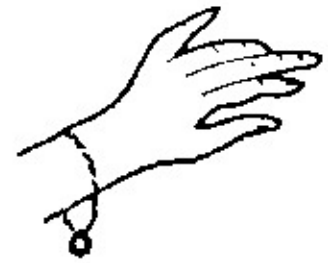
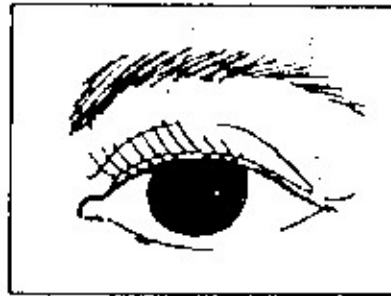

8

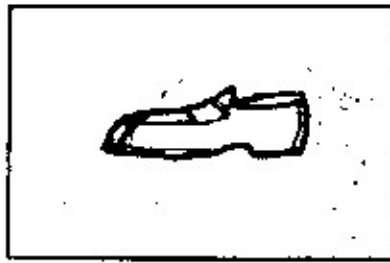

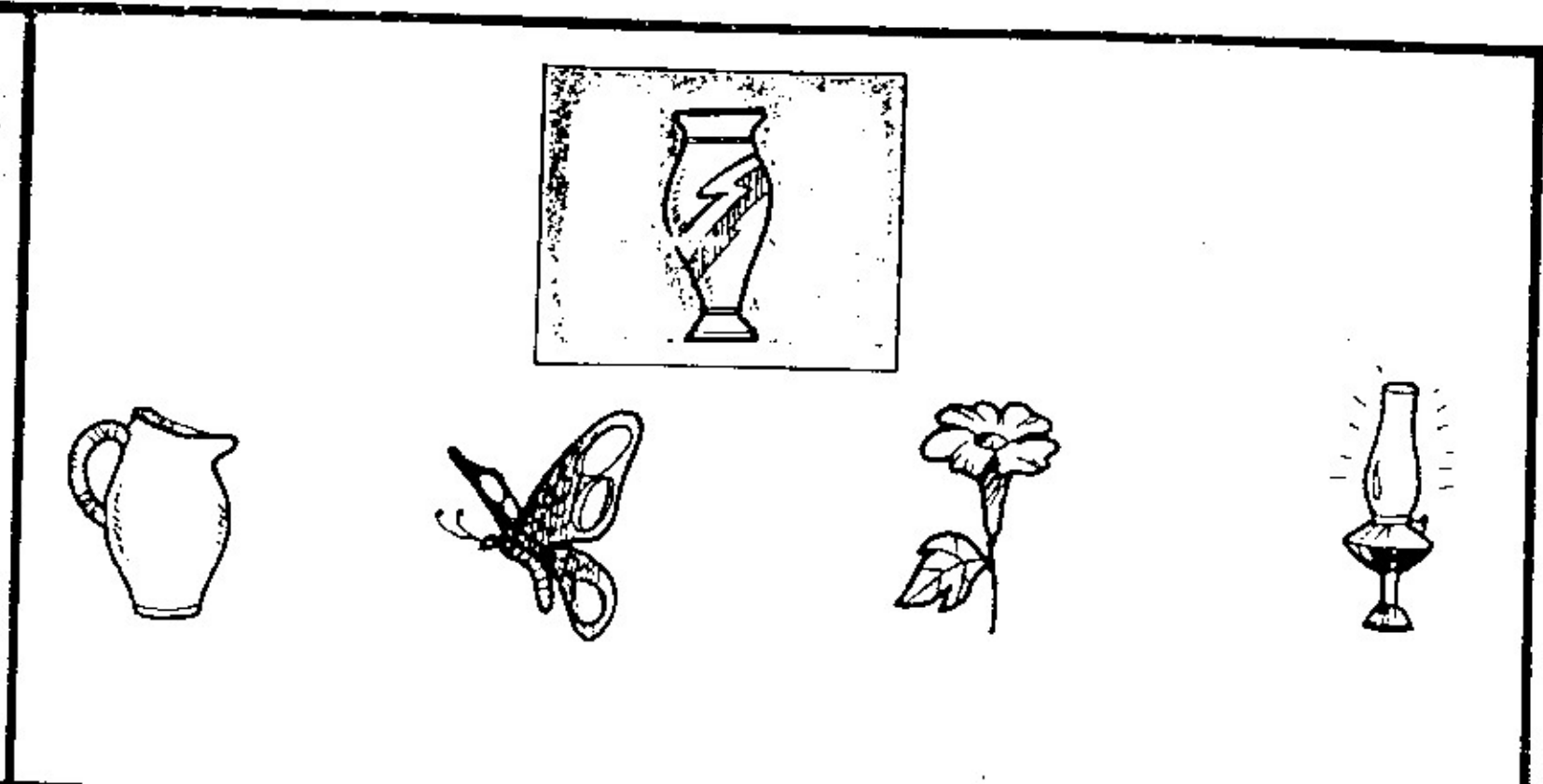
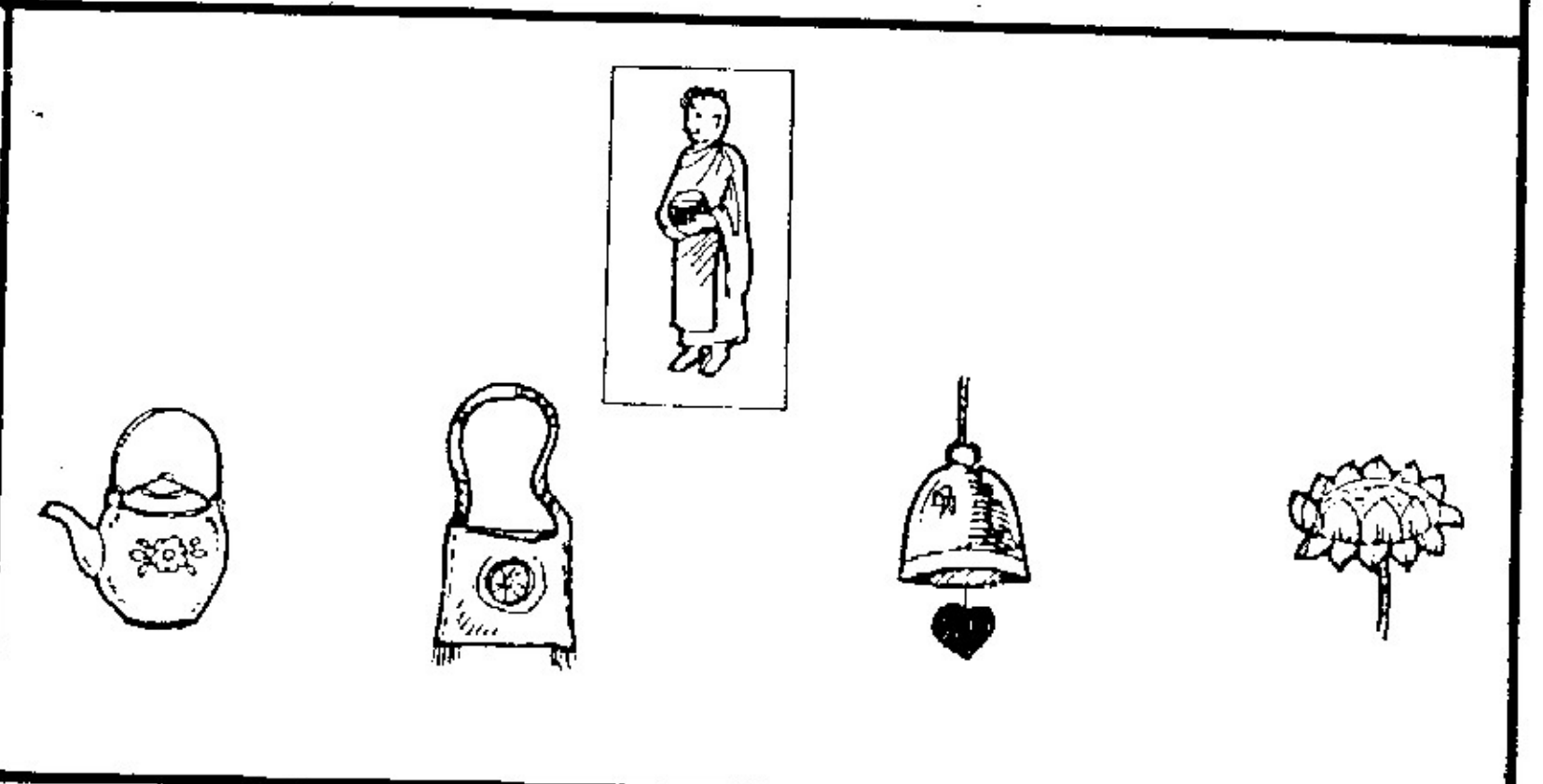
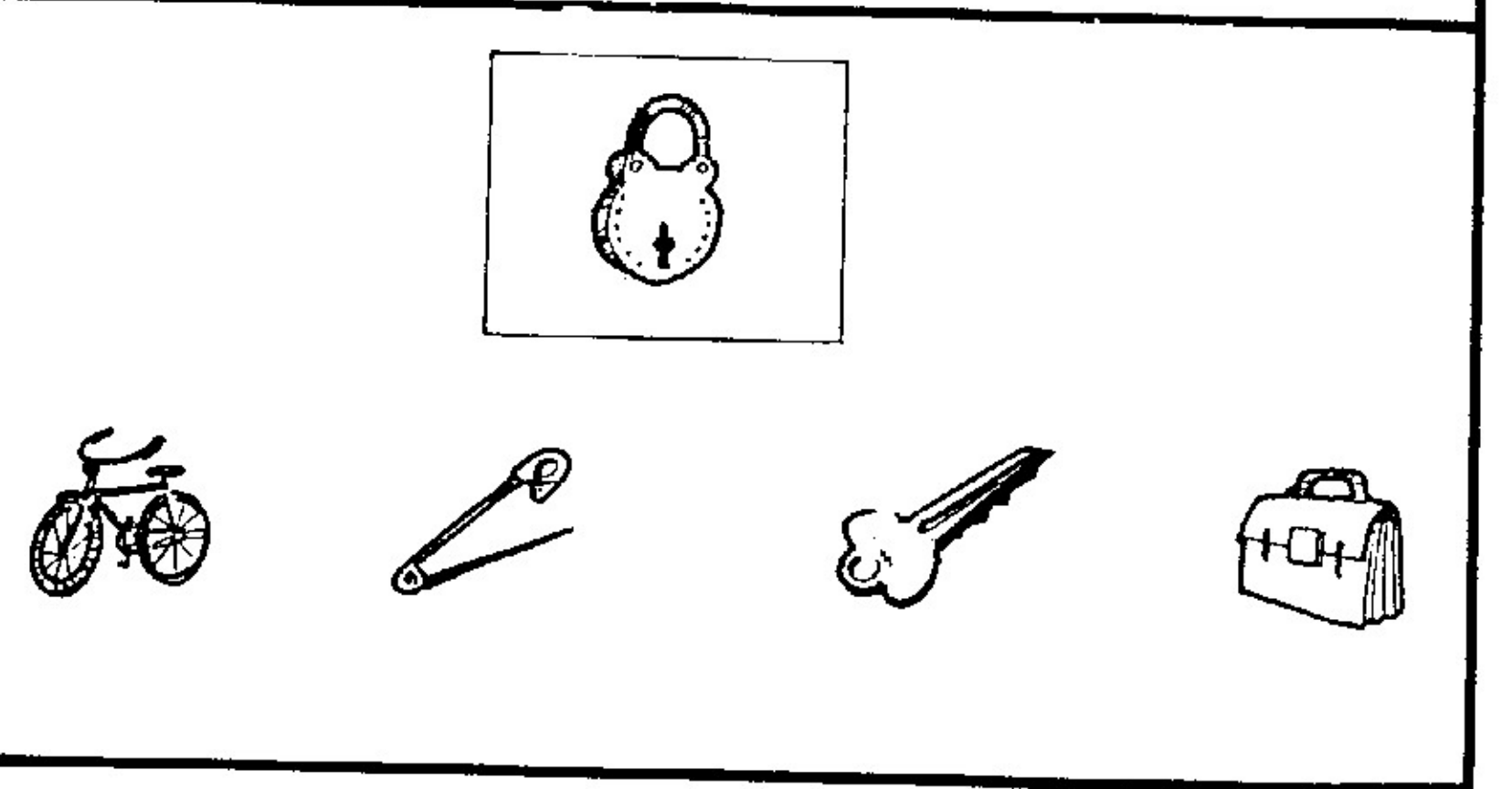
9	
10	
11	

12

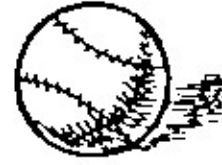
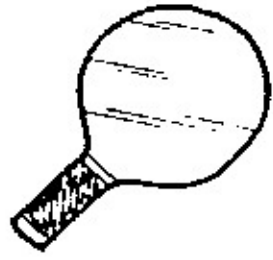

13

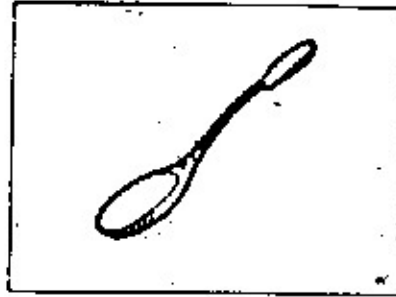

14



ดูนาฬิกา

เขียนตัวเลขบอกเวลา ตามนาฬิกาแต่ละเรือน

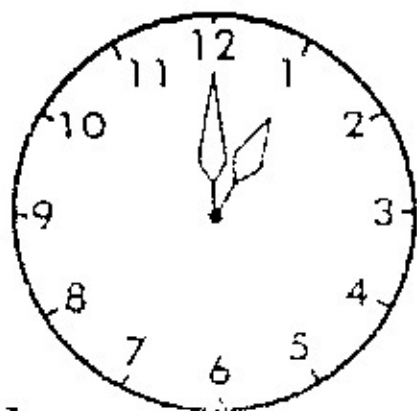

1.

นาฬิกา

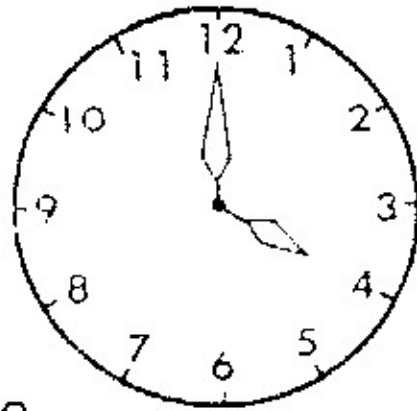

2.

นาฬิกา

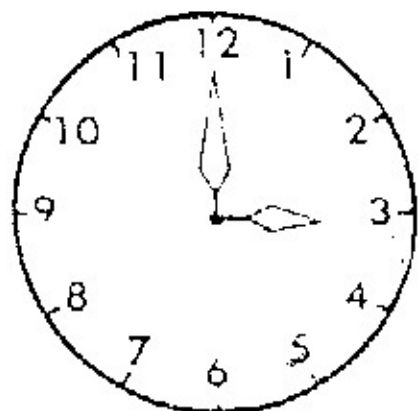
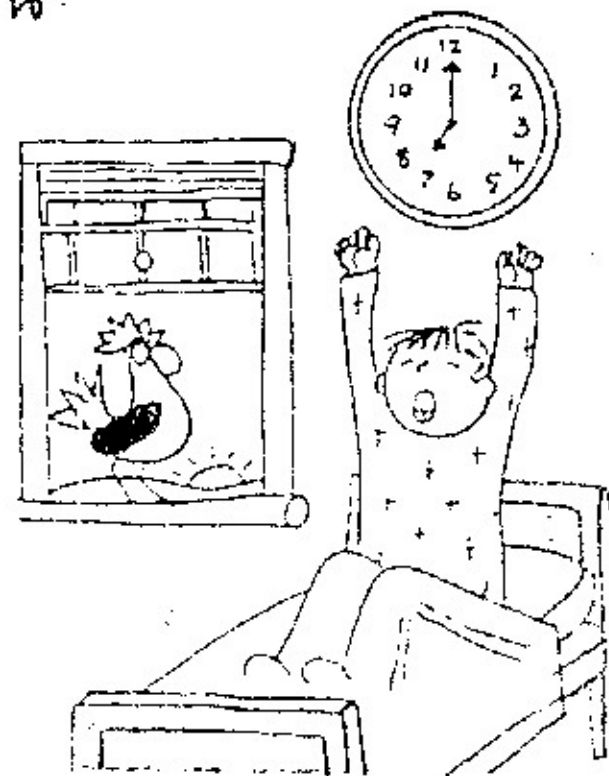

3.

นาฬิกา



4.

นาฬิกา

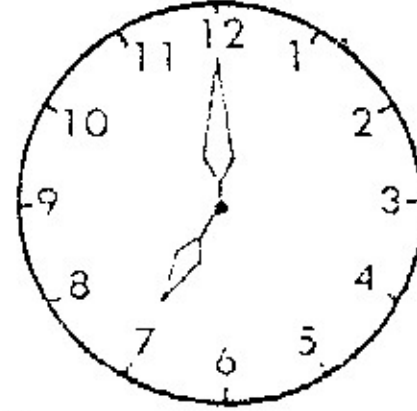

5.

นาฬิกา

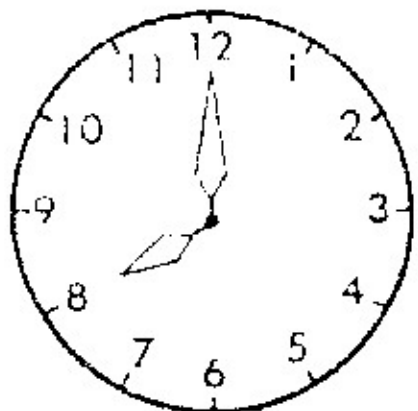

6.

นาฬิกา

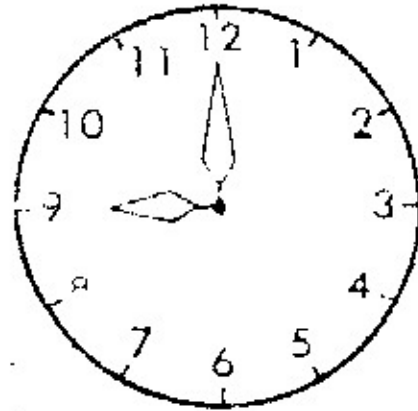

7.

นาฬิกา

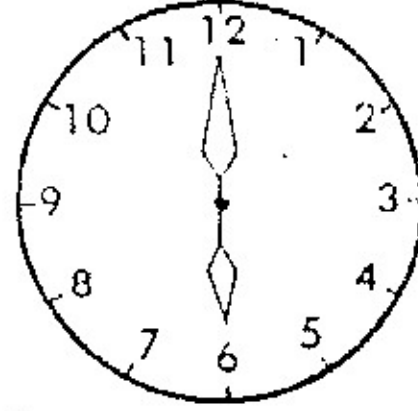

8.

นาฬิกา

จงเลือกภาพที่ประกอบกันลงตัว

<p>1</p>	<p>A </p> <p>B </p> <p>C </p> <p>D </p>
<p>2</p>	<p>A </p> <p>B </p> <p>C </p> <p>D </p>
<p>3</p>	<p>A </p> <p>B </p> <p>C </p> <p>D </p>
<p>4</p>	<p>A </p> <p>B </p> <p>C </p> <p>D </p>

5

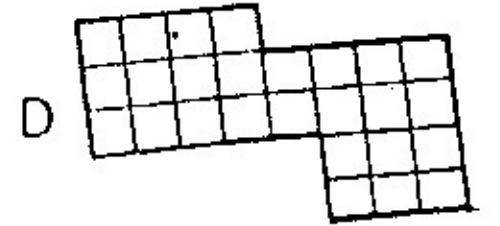
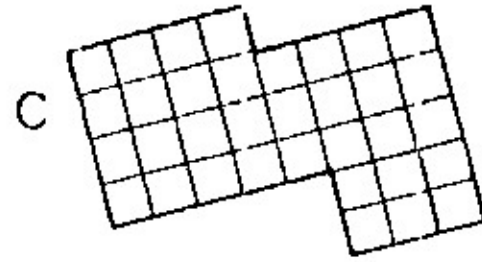
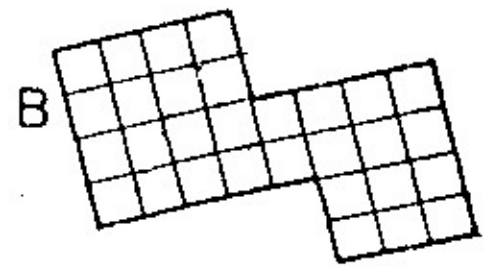
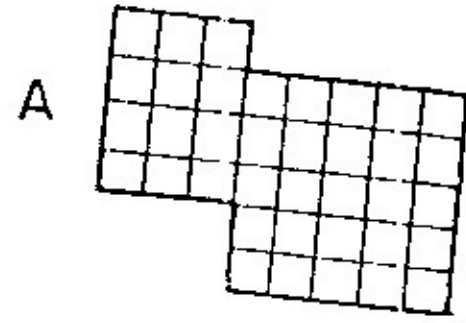
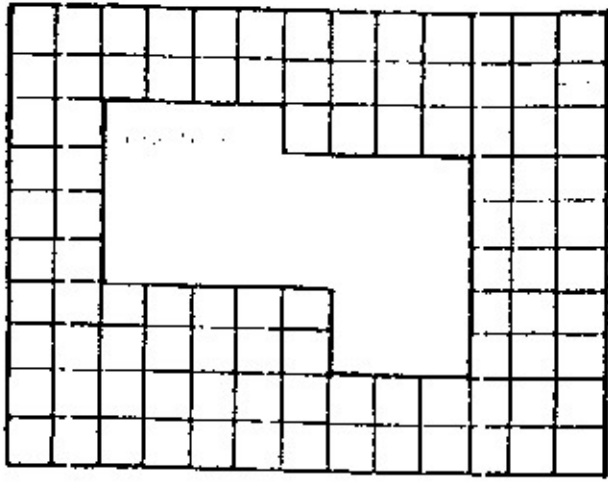

6

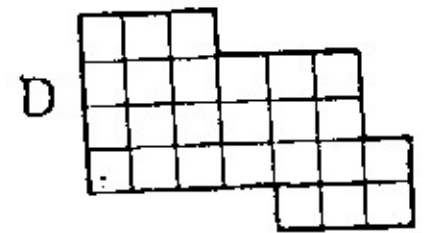
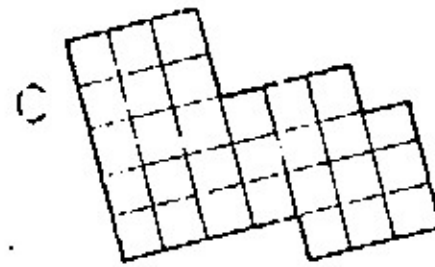
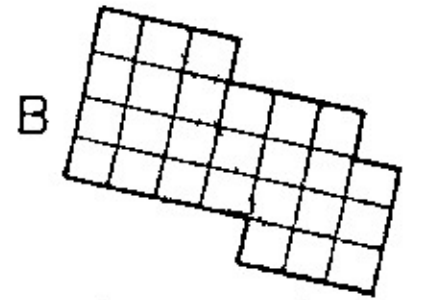
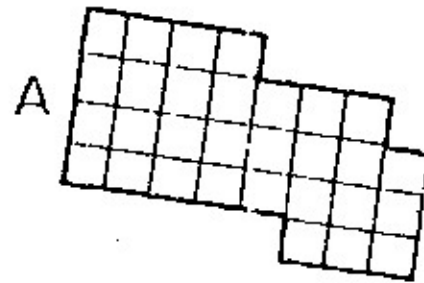
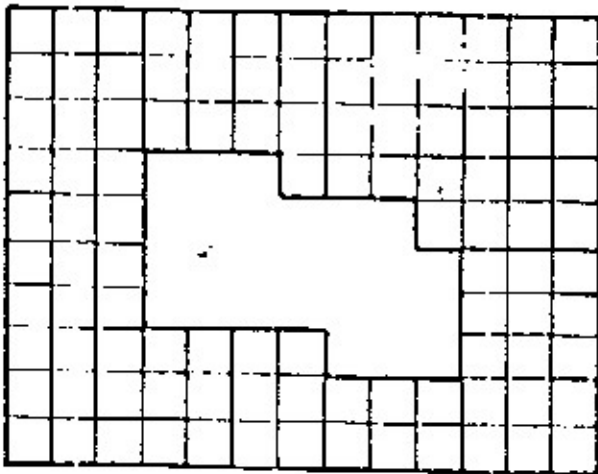

7

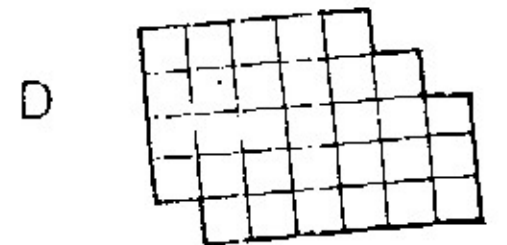
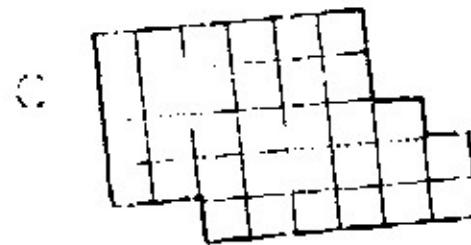
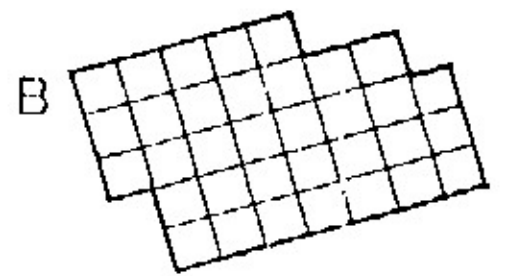
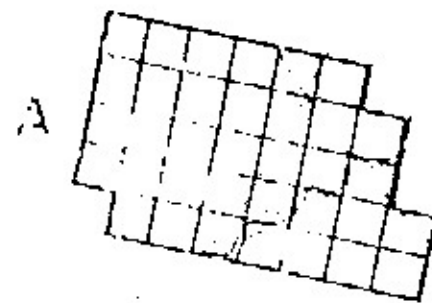
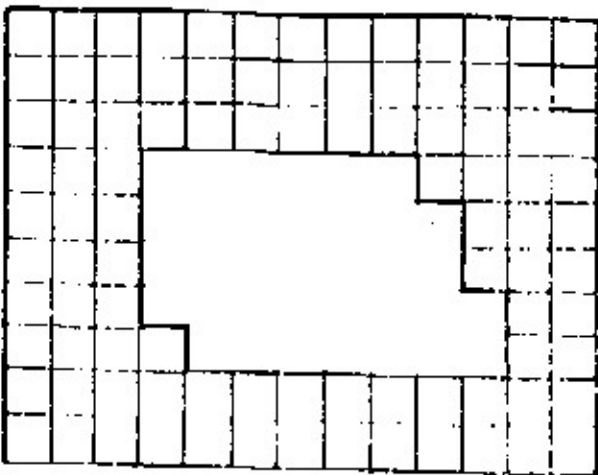

8

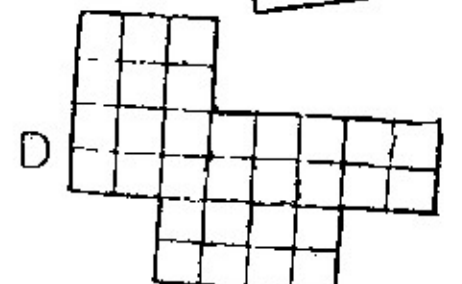
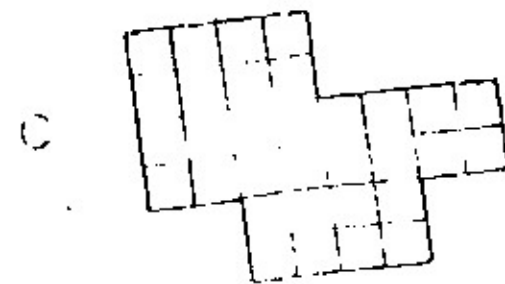
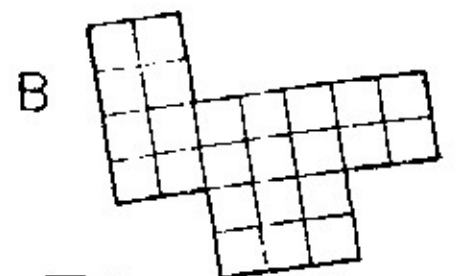
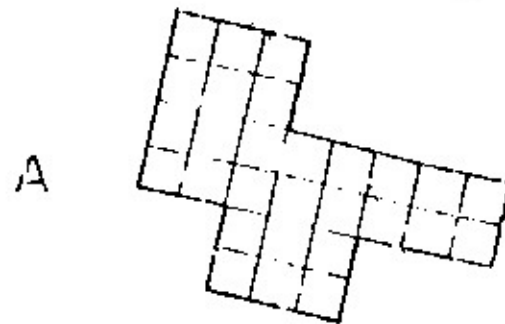
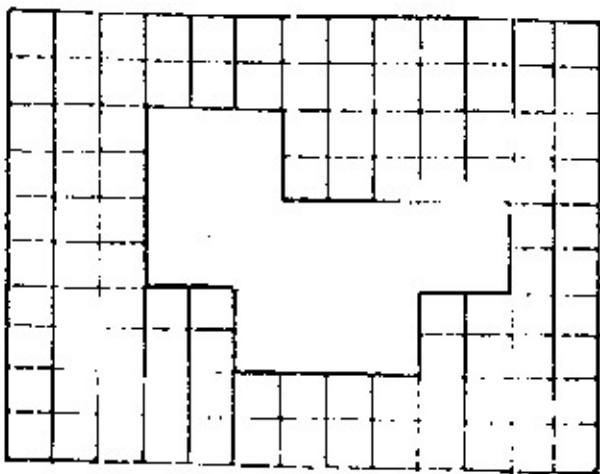

วัตถุประสงค์

เพื่อให้ผู้เรียนฝึกการสังเกต พิจารณาหาเหตุผลในความสัมพันธ์และความต่อเนื่องกันจากรูปทรงเรขาคณิต

คำสั่ง

ให้หาว่าภาพบนเส้นประจะเป็นภาพใดที่อยู่ด้านล่างแล้วขีด/ทับภาพนั้น

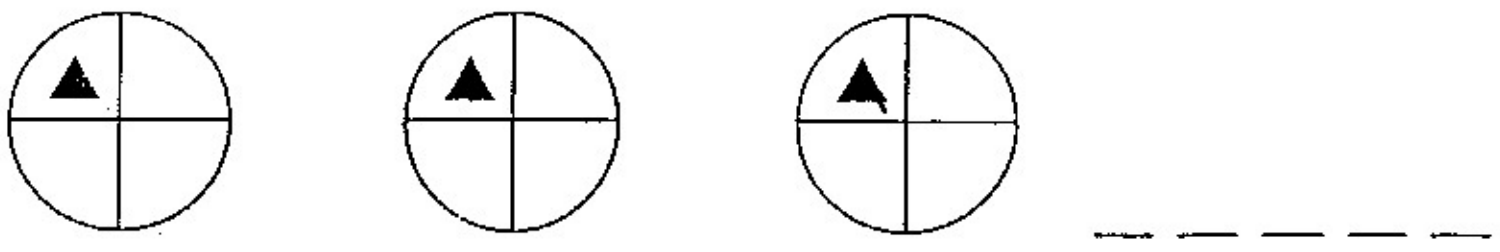
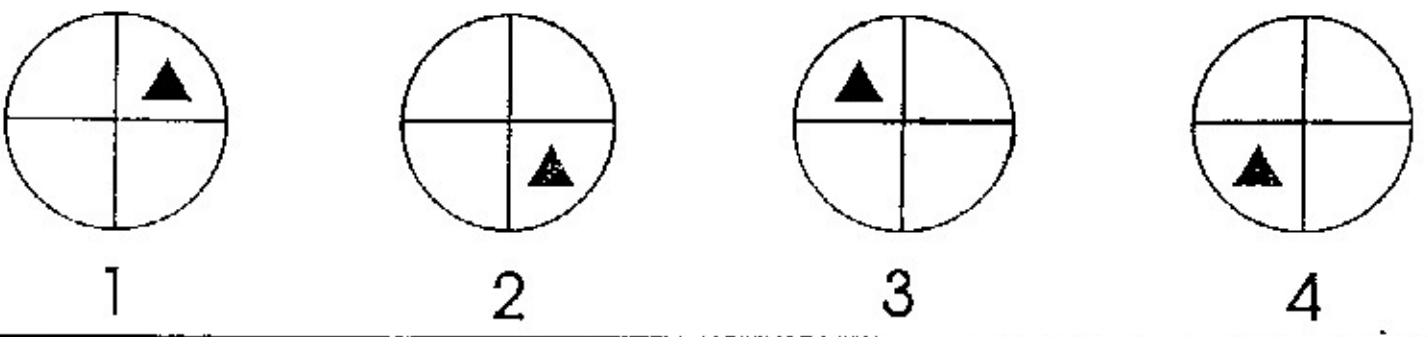
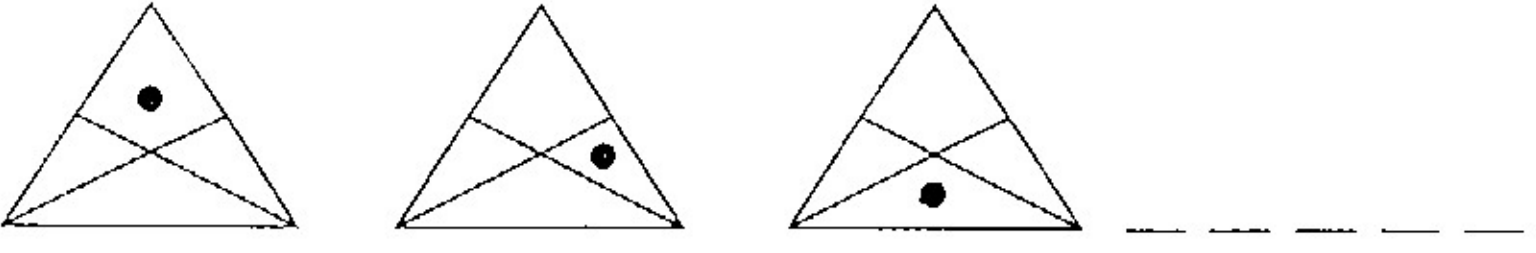
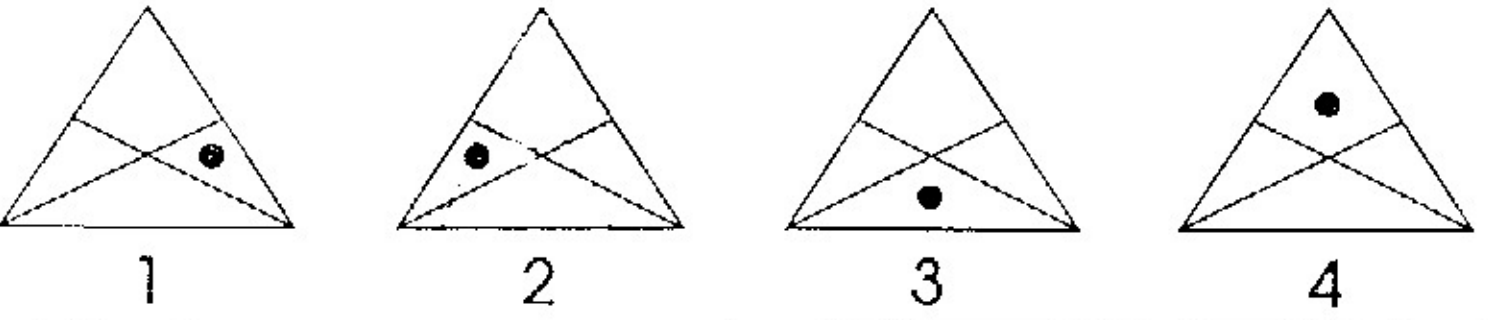
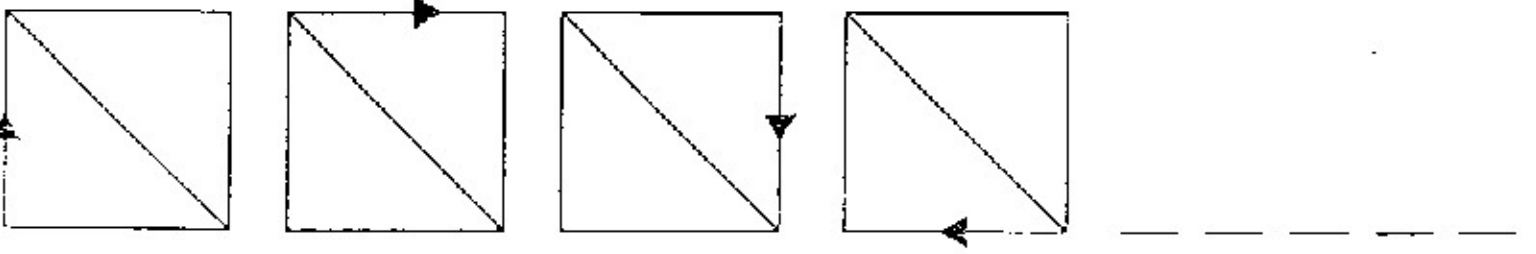
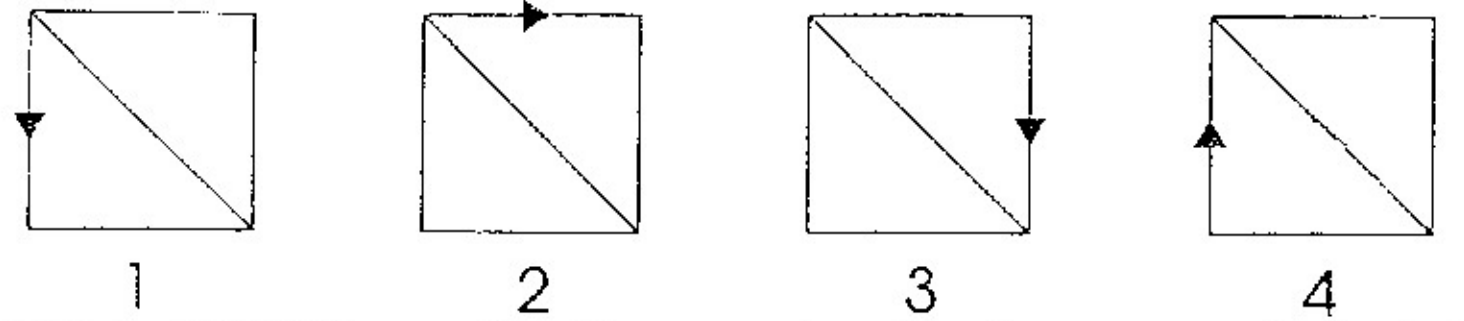
1	
	
2	
	
3	
	

4

5

6

1 2 3 4

1 2 3 4

1 2 3 4

7

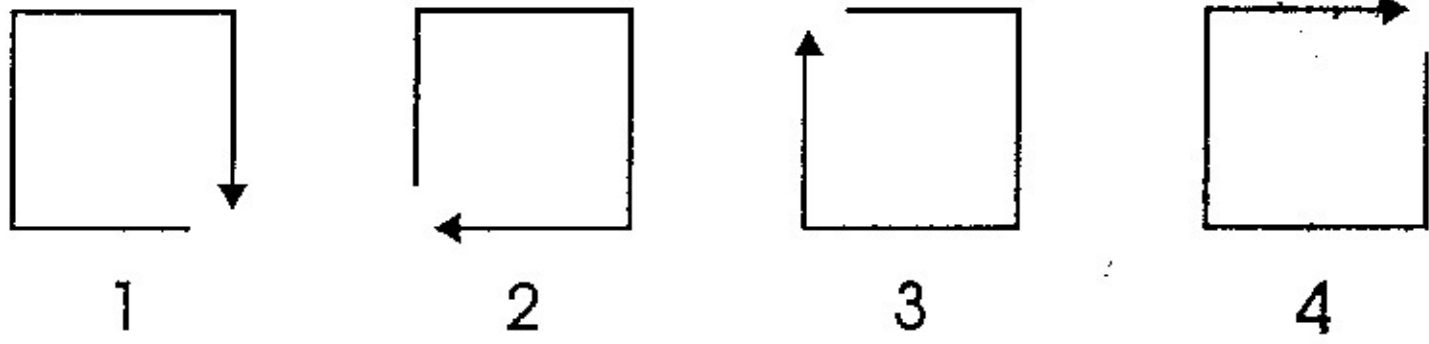
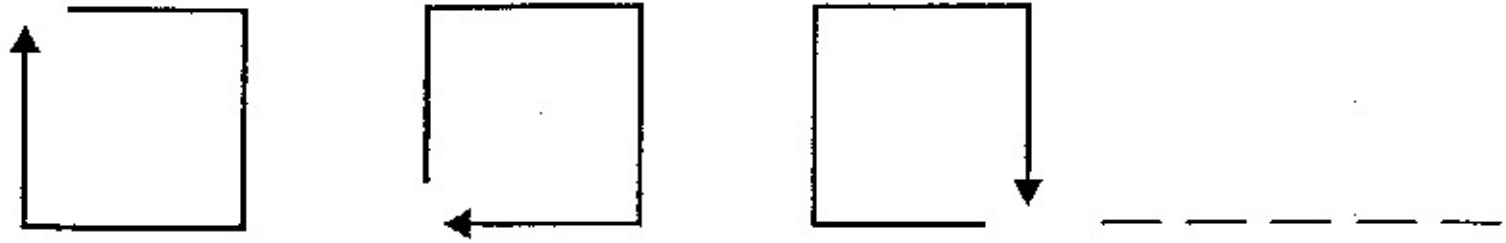

8

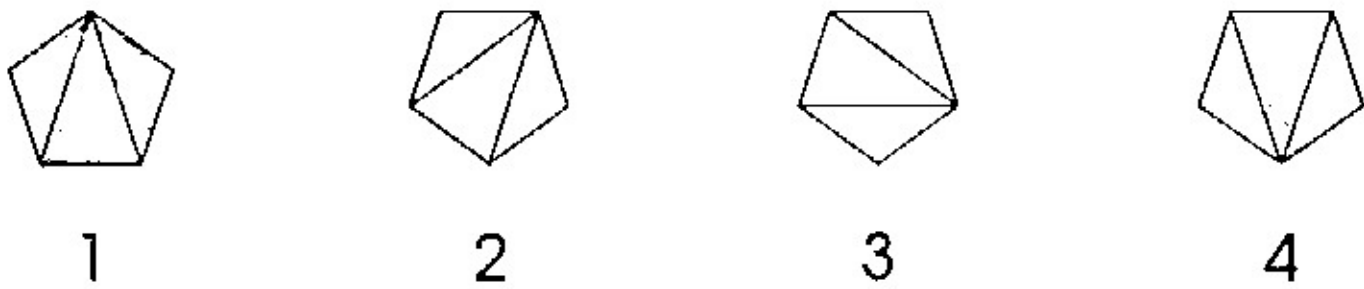

9

