

จงกาบทบาทภาพที่ตรงกับคำเรียกในช่องแรก

1

คั้น



ก

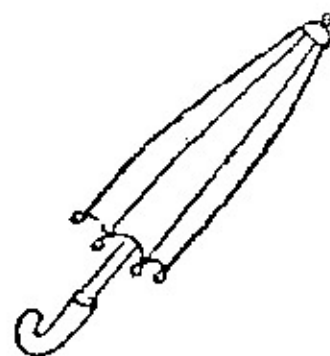

ข

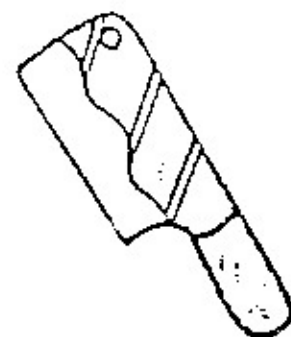

ค

2

ช่อ



ก

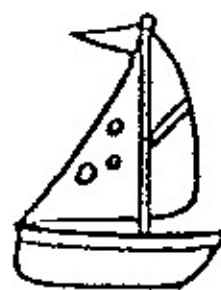

ข

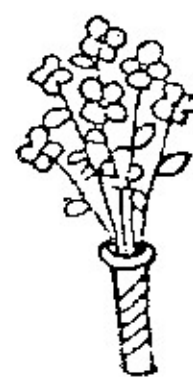

ค

3

เล่ม

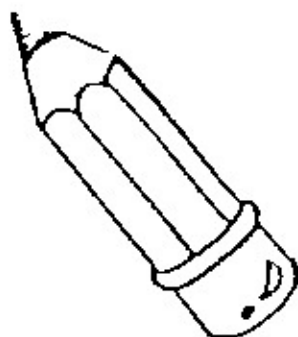

ก

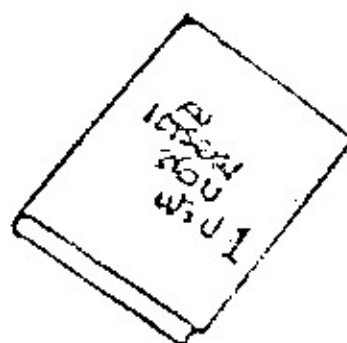

ข

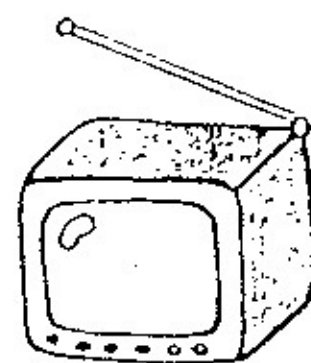

ค

4

ใบ



ก





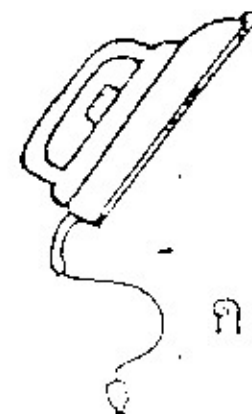





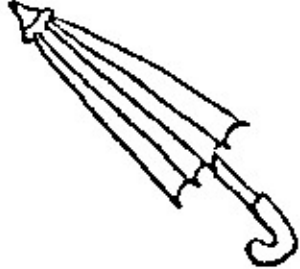
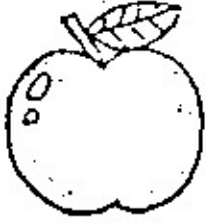

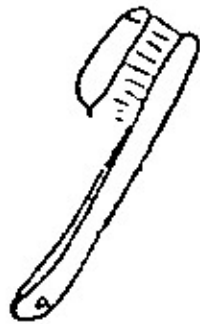
ข

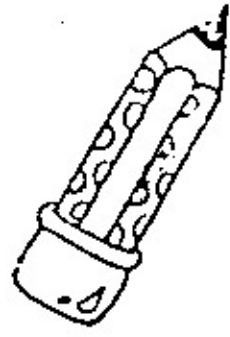
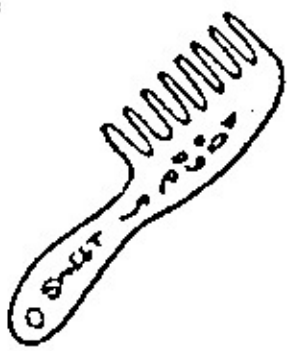
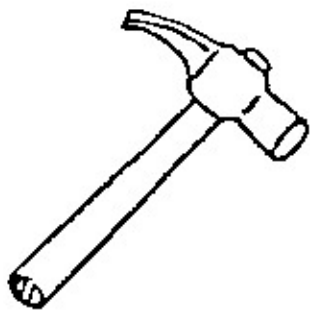

ค

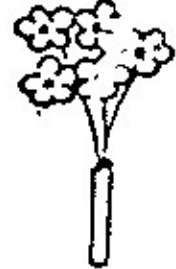
จงเลือกภาพมาให้ตรงกับคำเรียกในช่องแรก

| | | | |
|-----------------------|---|--|--|
| <p>5</p> <p>ผล</p> | <p>ก</p>  | <p>ข</p>  | <p>ค</p>  |
| <p>6</p> <p>อื่น</p> | <p>ก</p>  | <p>ข</p>  | <p>ค</p>  |
| <p>7</p> <p>เวียน</p> | <p>ก</p>  | <p>ข</p>  | <p>ค</p>  |
| <p>8</p> <p>แท่ง</p> | <p>ก</p>  | <p>ข</p>  | <p>ค</p>  |
| <p>9</p> <p>ใบ</p> | <p>ก</p>  | <p>ข</p>  | <p>ค</p>  |

จงลากเส้นจากภาพที่ตรงกับคำในช่องว่าง

๓๐

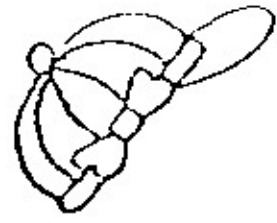

ก

ข

ค

ตัว

เล่ม

ใบ

๓๑

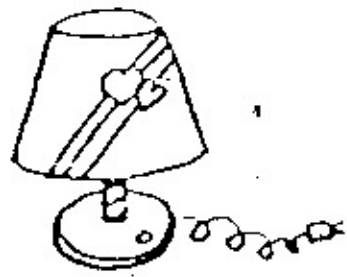

ก

ข

ค

อัน

แท่ง

ตัว

๓๒

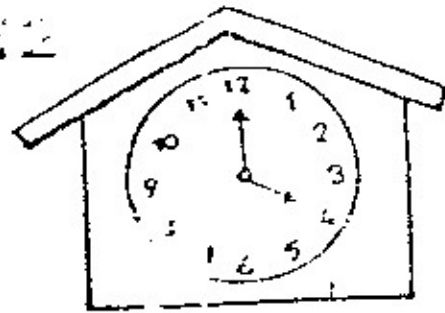

ก

ข

ค

ชิ้น

เรือน

อัน

๓๓



ก

ข

ค

ตัว

ชิ้น

เล่ม

๓๔

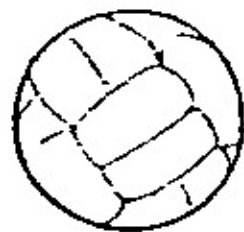

ก

ข

ค



ลูก

ก้อน

ตัว

ครูหรือผู้ปกครองอธิบายได้แก่ : (ให้ความเข้าใจละประมาณ ๓๐-๕๐ วินาที)

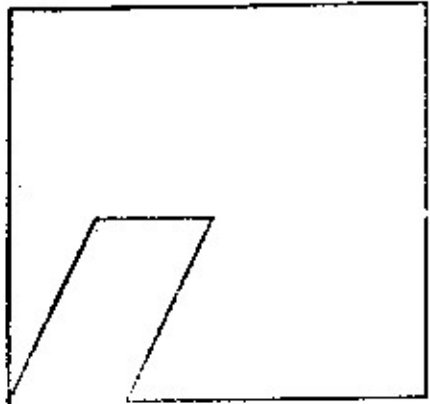
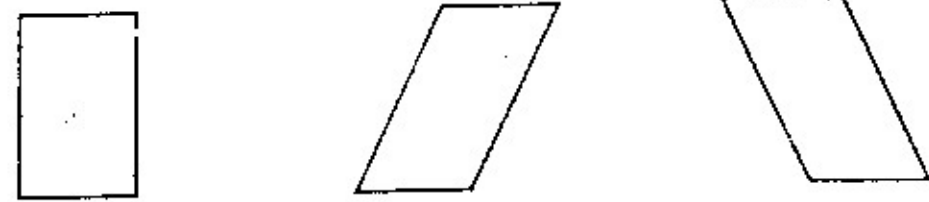
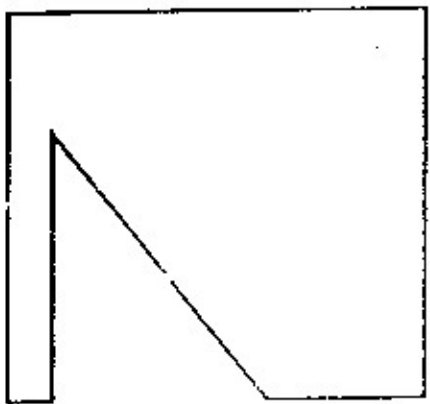
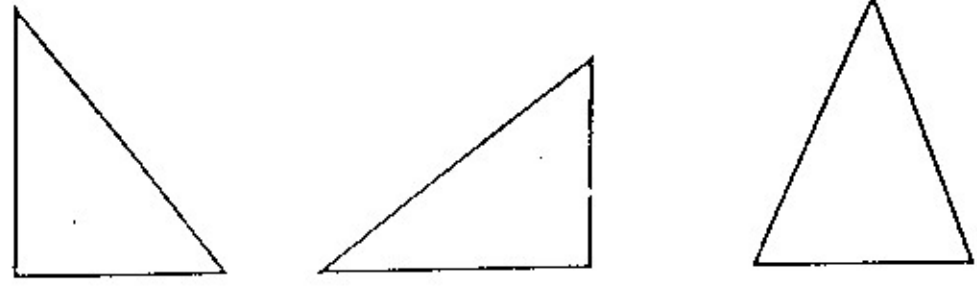
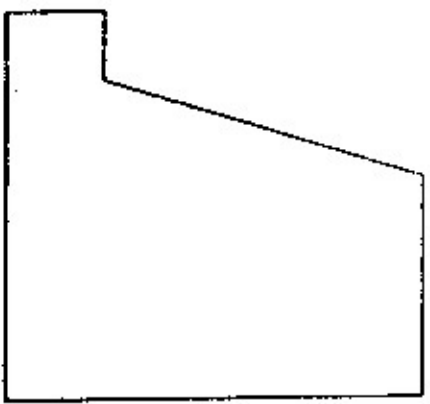
กิจกรรมเพิ่มเติม : หลังจากทดสอบแบบวัดความพร้อมชุดนี้แล้ว ให้เด็กลากเส้นต่อเติมภาพทางซ้ายมือในกรอบ □ และระบายสีส่วนที่เกิดขึ้นจากการต่อเติมภาพนี้ให้สวยงาม

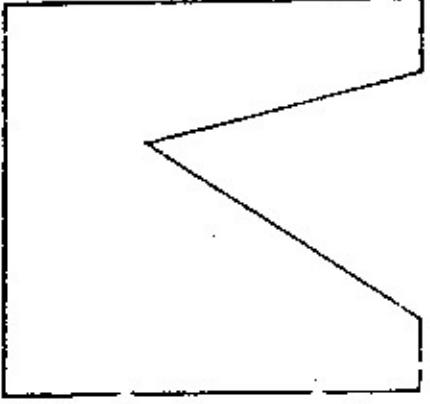
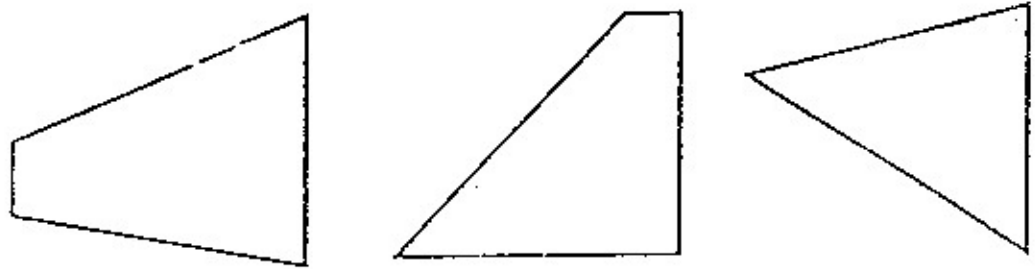
| | |
|--|--|
| <p>ตัวอย่าง</p>  |  |
| <p>ตัวอย่าง</p>  |  |
| <p>๑.</p>  |  |
| <p>๒.</p>  |  |

၆.

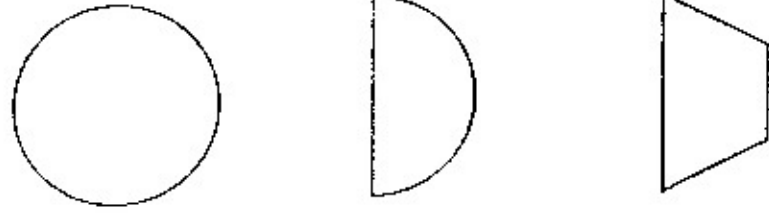
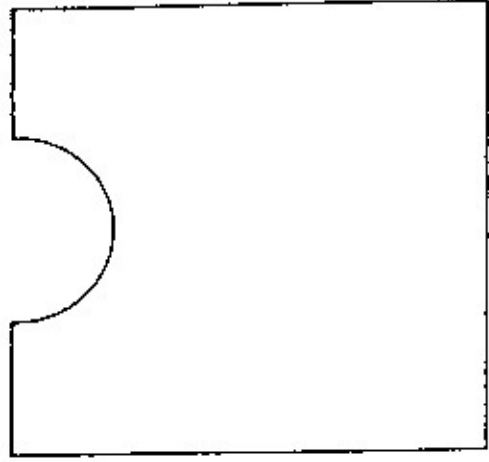

၇.

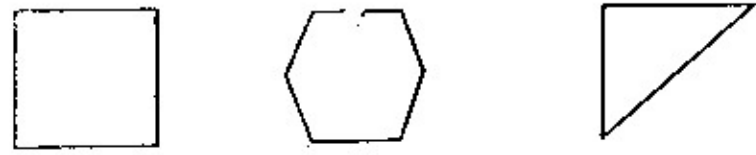
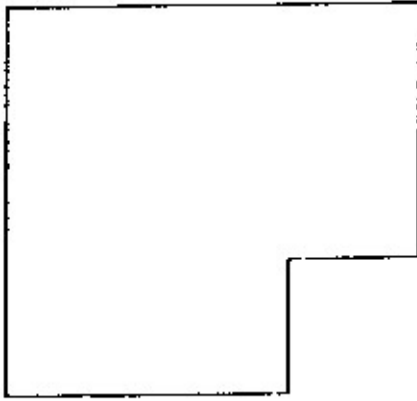

၈.

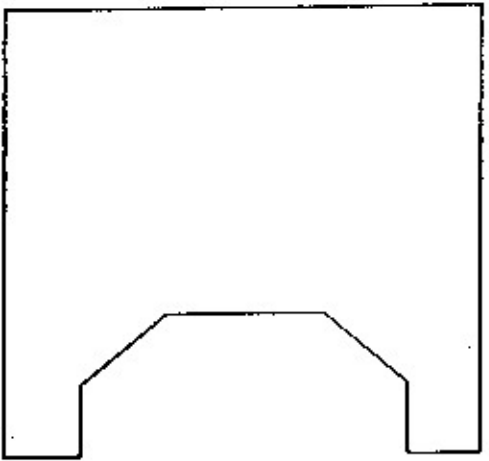

၉.

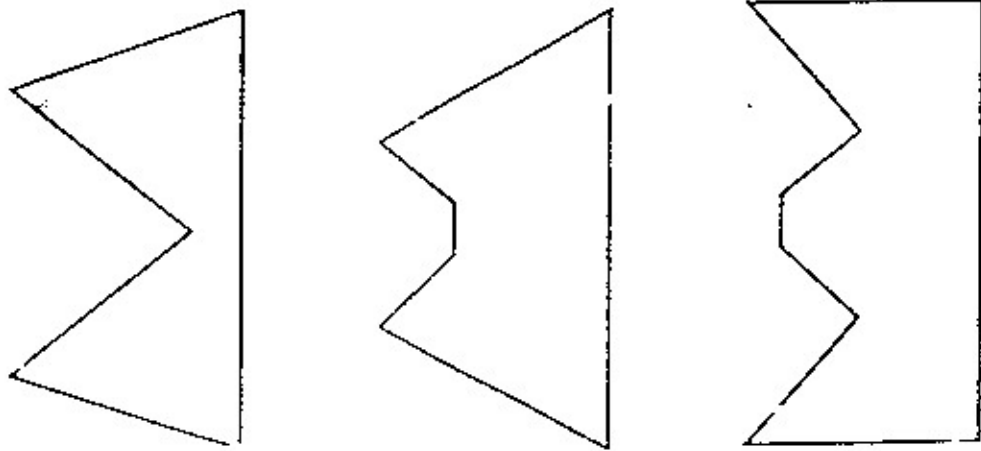
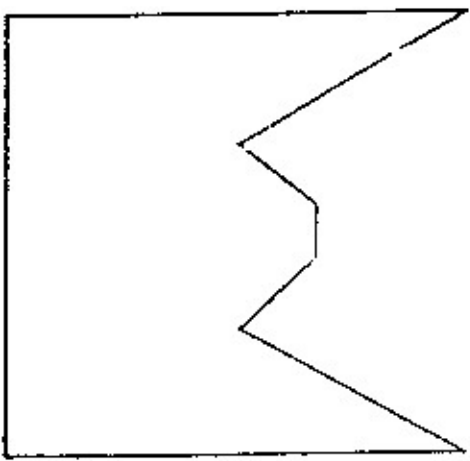

၈၉.

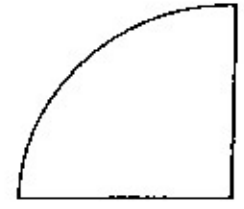
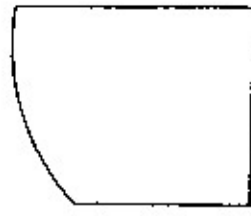
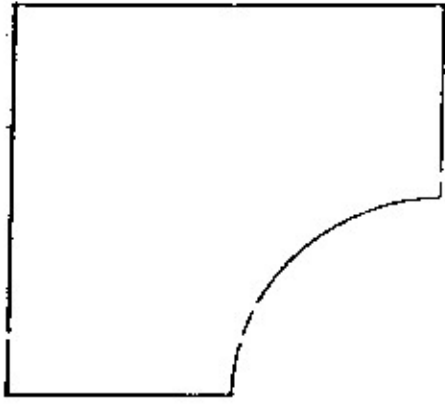

၉၀.

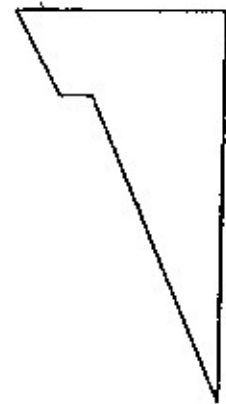
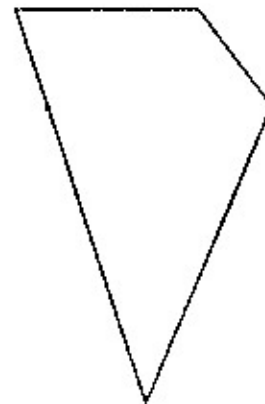
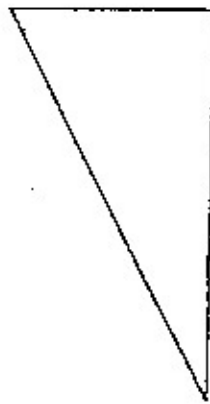
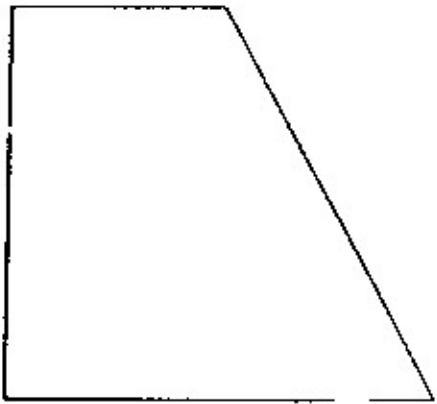



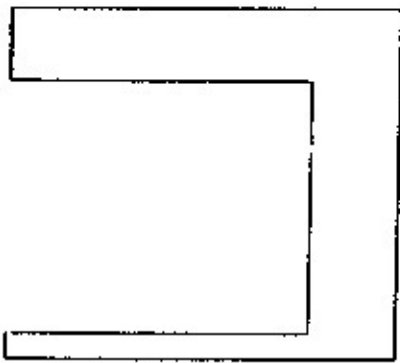



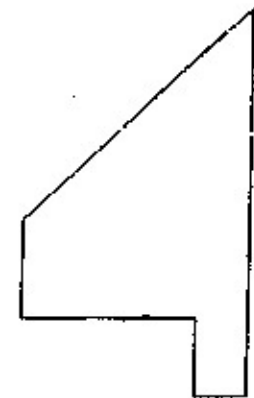
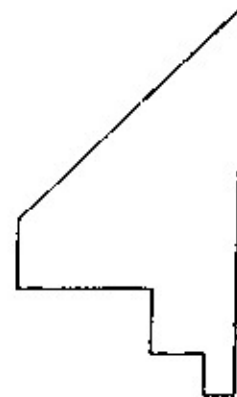
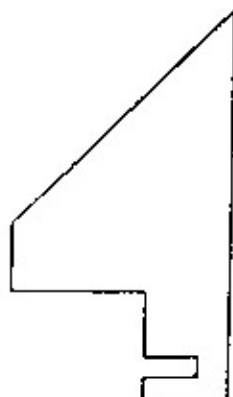
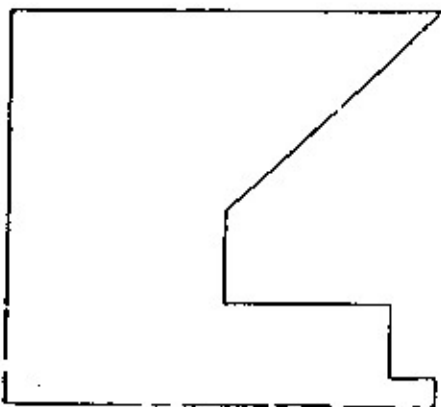

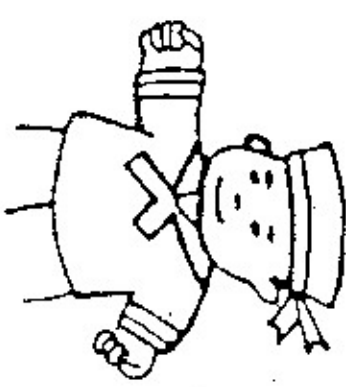
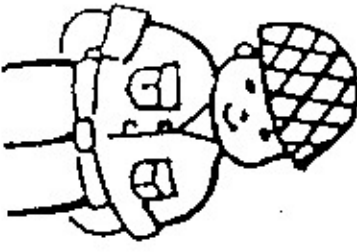
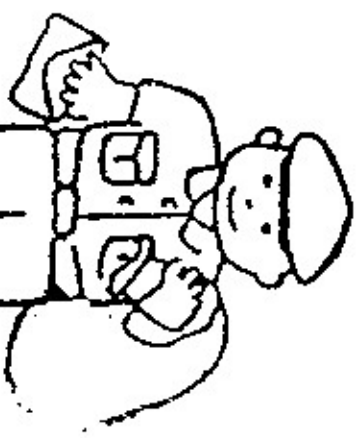
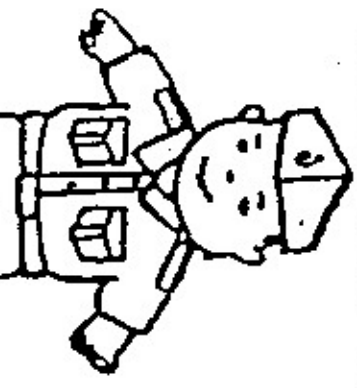
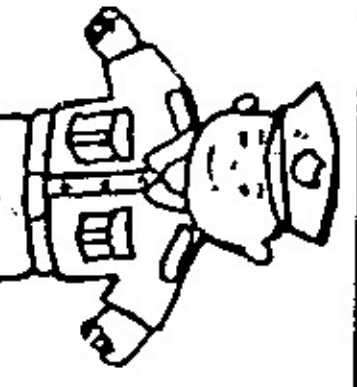





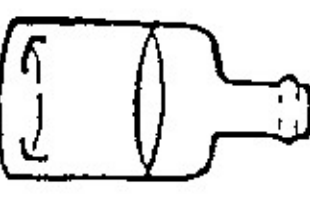

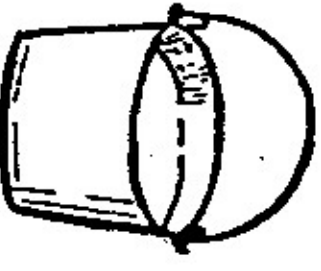
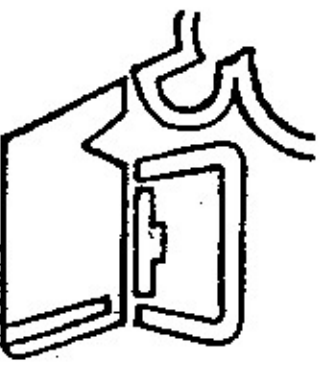





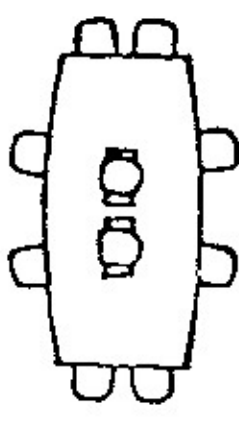
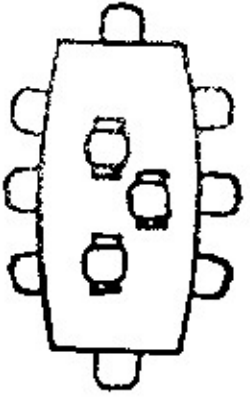
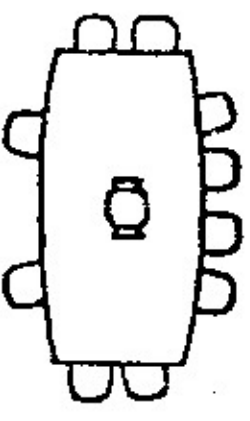
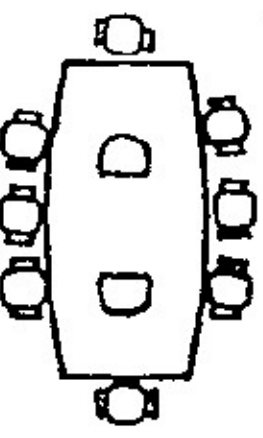
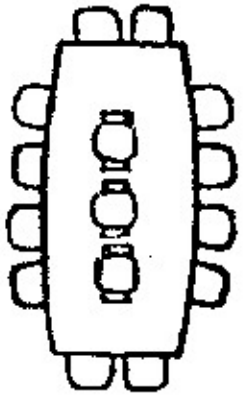

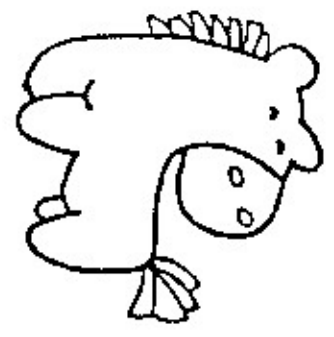

၉၁.

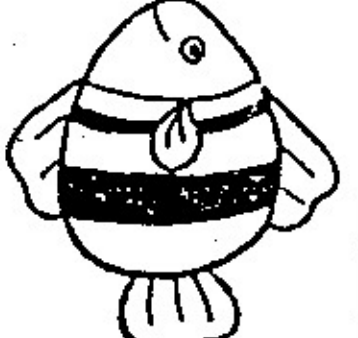
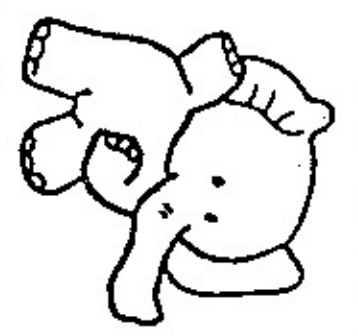
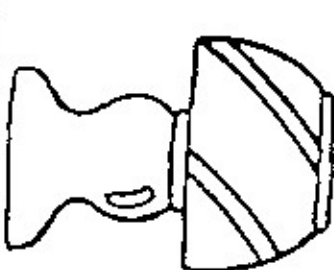

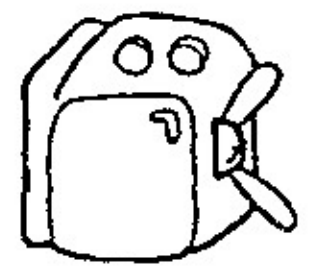

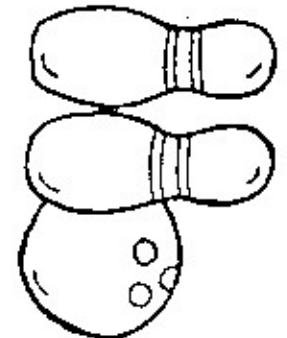

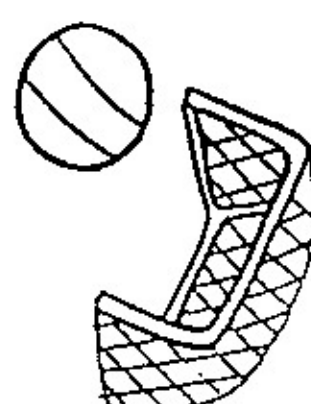
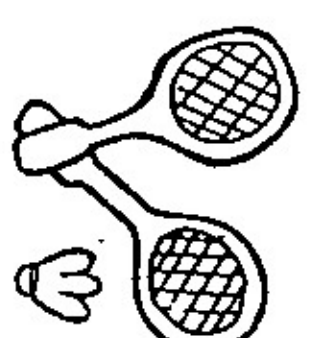
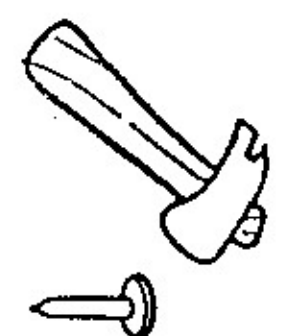
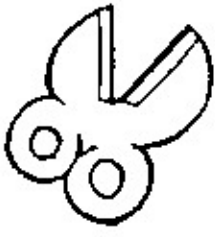
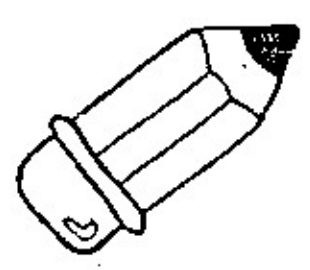
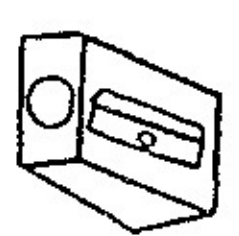
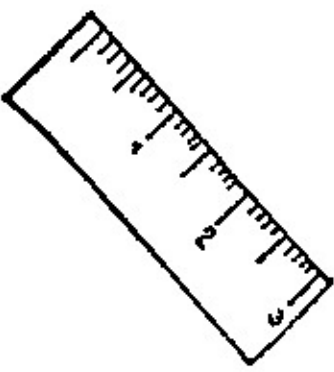
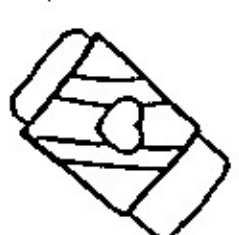

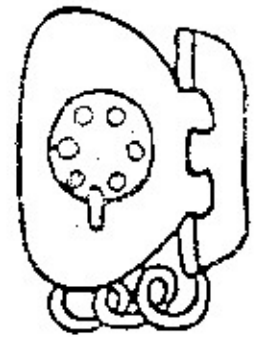
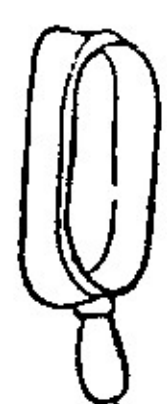
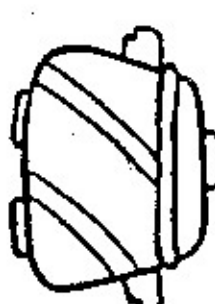
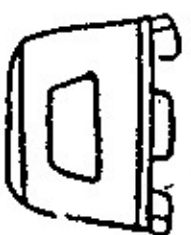

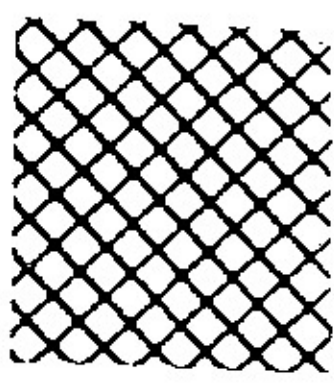
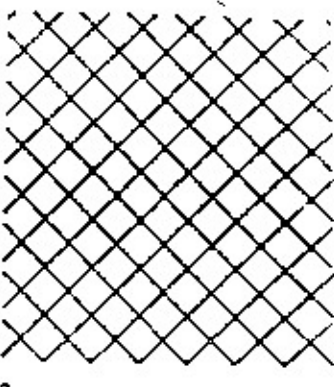
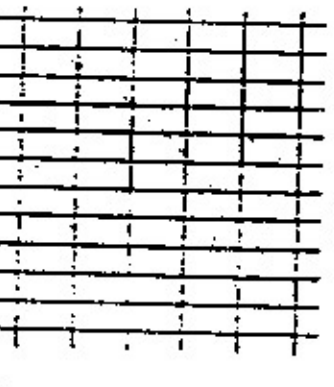
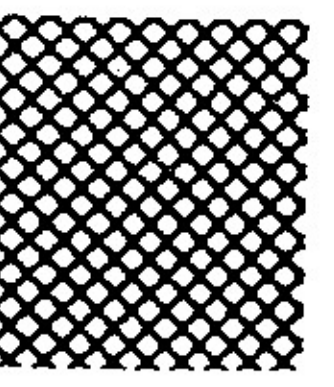
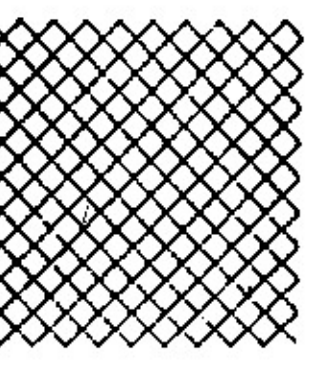

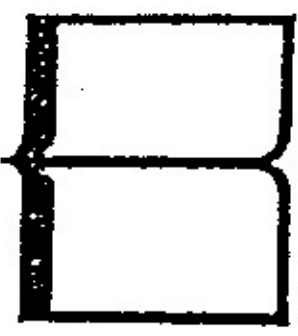

၉၂.

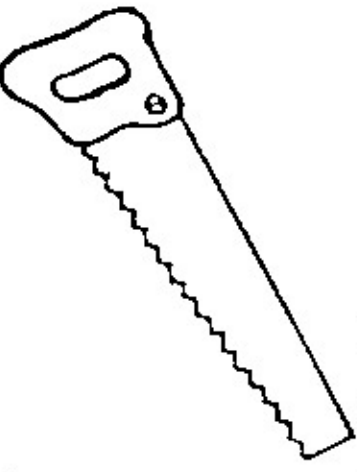
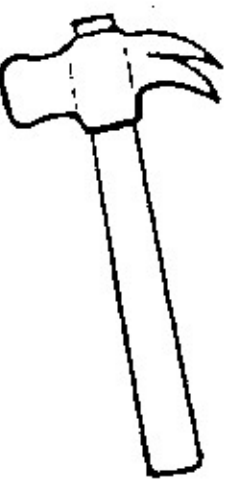

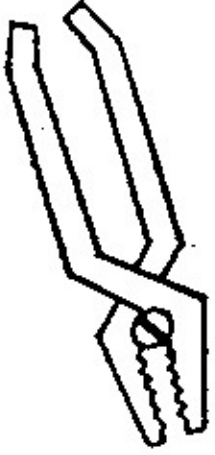
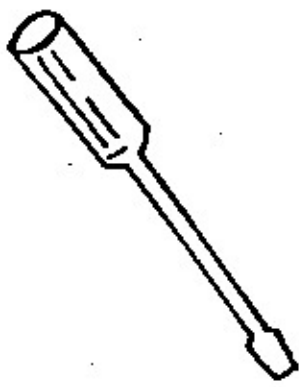
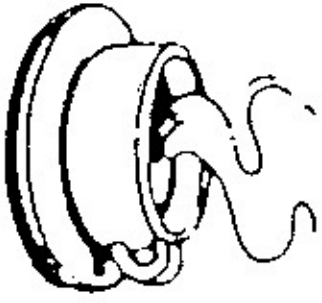
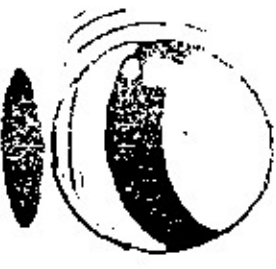
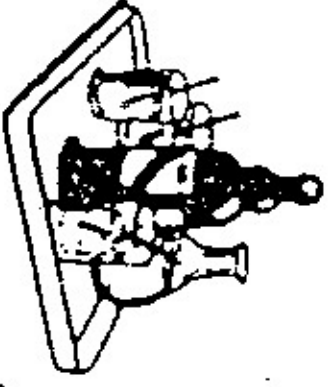
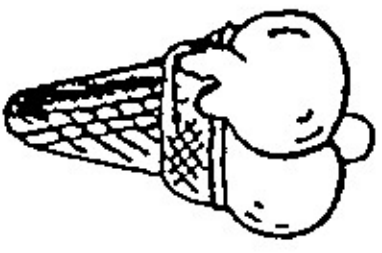
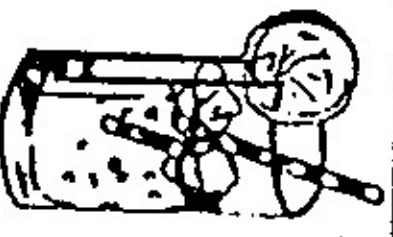
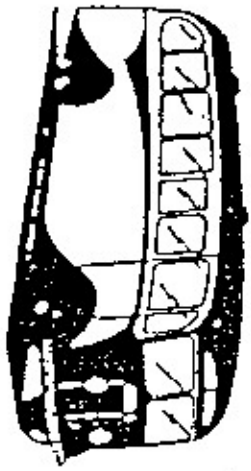
| | | | | |
|--|---|--|--|--|
|  <p>1</p> |  <p>2</p> |  <p>3</p> |  <p>4</p> |  <p>5</p> |
|  <p>1</p> |  <p>2</p> |  <p>3</p> |  <p>4</p> |  <p>5</p> |
|  <p>1</p> |  <p>2</p> |  <p>3</p> |  <p>4</p> |  <p>5</p> |
|  <p>1</p> |  <p>2</p> |  <p>3</p> |  <p>4</p> |  <p>5</p> |
|  <p>1</p> |  <p>2</p> |  <p>3</p> |  <p>4</p> |  <p>5</p> |

| | | | | |
|---|---|--|--|--|
| <p>5</p>  <p>U</p> |  <p>R</p> |  <p>A</p> |  <p>F</p> |  <p>D</p> |
| <p>7</p>  <p>U</p> |  <p>R</p> |  <p>A</p> |  <p>F</p> |  <p>D</p> |
| <p>8</p>  <p>U</p> |  <p>R</p> |  <p>A</p> |  <p>F</p> |  <p>D</p> |
| <p>9</p>  <p>U</p> |  <p>R</p> |  <p>A</p> |  <p>F</p> |  <p>D</p> |
| <p>10</p>  <p>U</p> |  <p>R</p> |  <p>A</p> |  <p>F</p> |  <p>D</p> |

| | | | | |
|--|---|--|--|--|
|  <p>U</p> |  <p>R</p> |  <p>A</p> |  <p>7</p> |  <p>a</p> |
|  <p>U</p> |  <p>R</p> |  <p>A</p> |  <p>7</p> |  <p>a</p> |
|  <p>U</p> |  <p>R</p> |  <p>A</p> |  <p>7</p> |  <p>a</p> |
|  <p>U</p> |  <p>R</p> |  <p>A</p> |  <p>7</p> |  <p>a</p> |
|  <p>U</p> |  <p>R</p> |  <p>A</p> |  <p>7</p> |  <p>a</p> |

12

13

14

15

16.

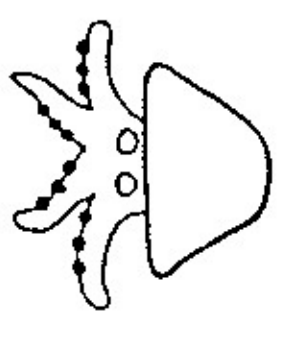

U

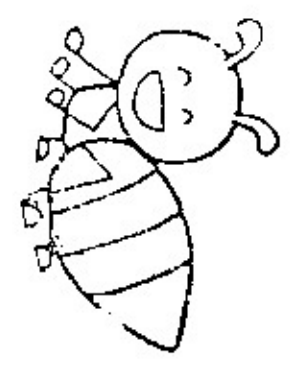

B

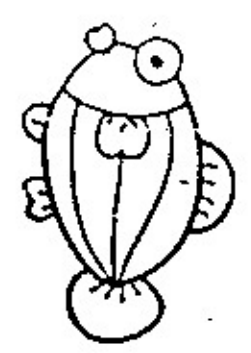

A



S

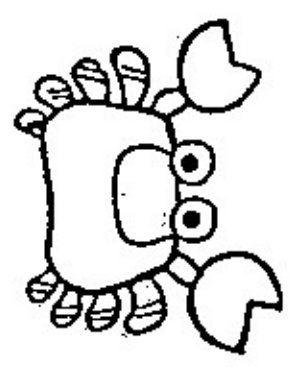

A

17

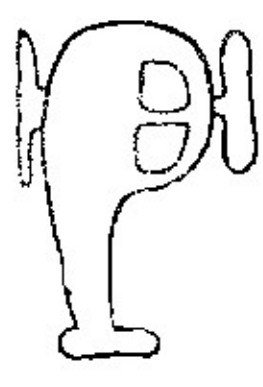

U

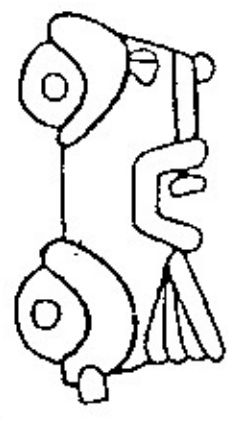

B

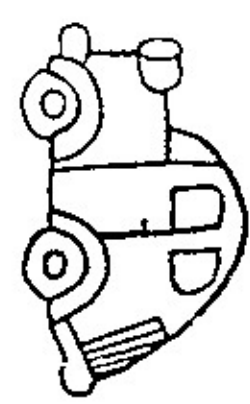

A

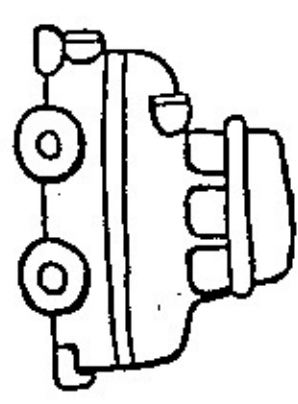

S

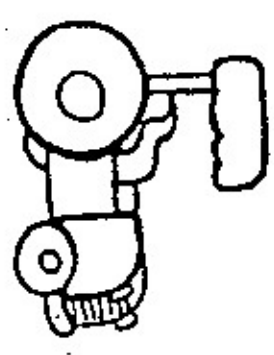

A

18

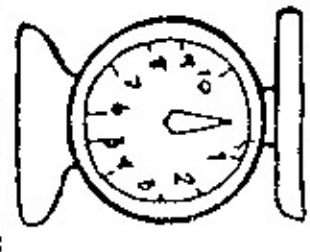

U

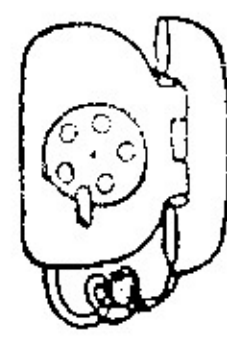

B

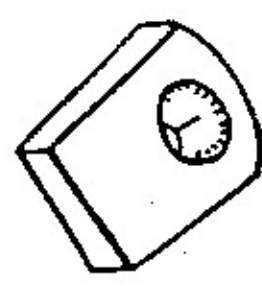

A

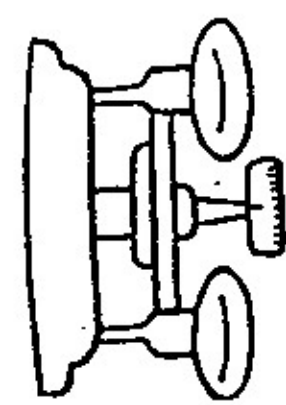

S

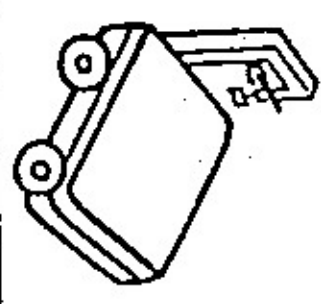

A

19



U



B

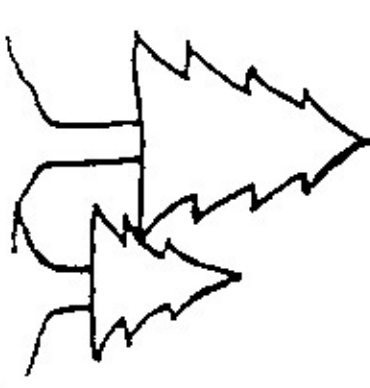

A

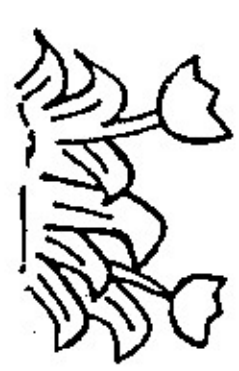

S



A

20

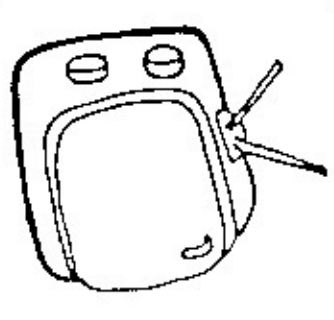

U

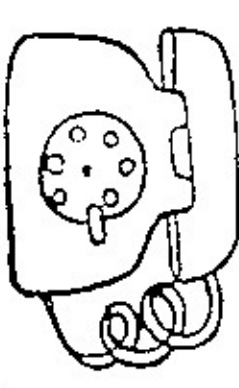

B



A

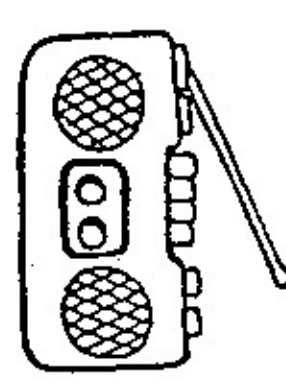

S

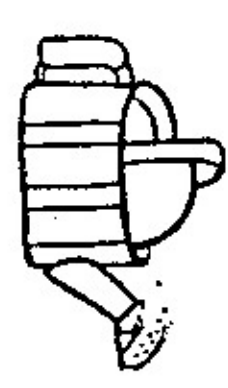

A

21



n

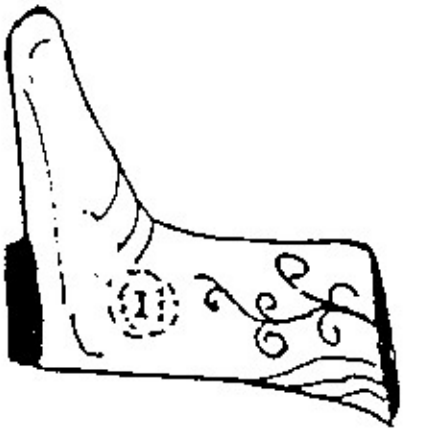

п



а

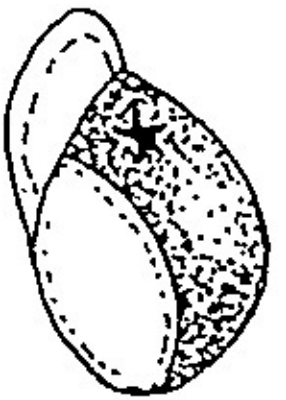

я

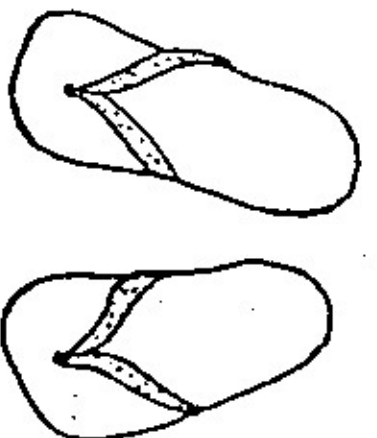

а

22



n

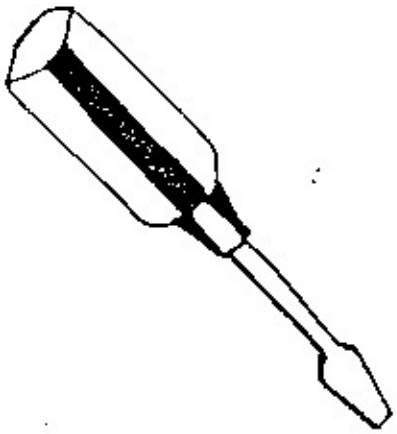

п

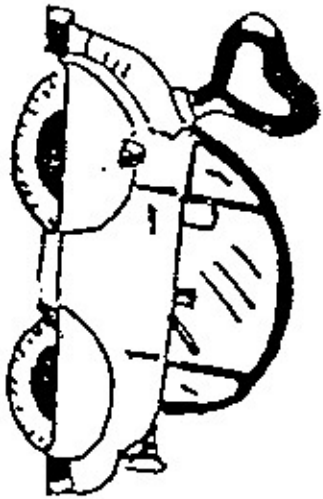

а



я



а

23



n



п

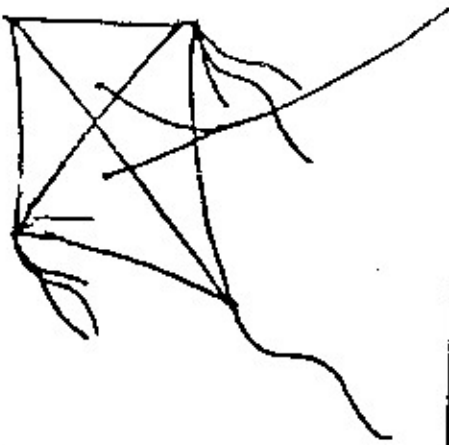

а



я



а

24



n



п



а

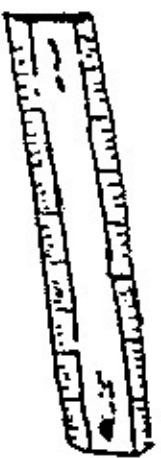



а

ภาพต่อเนื่อง

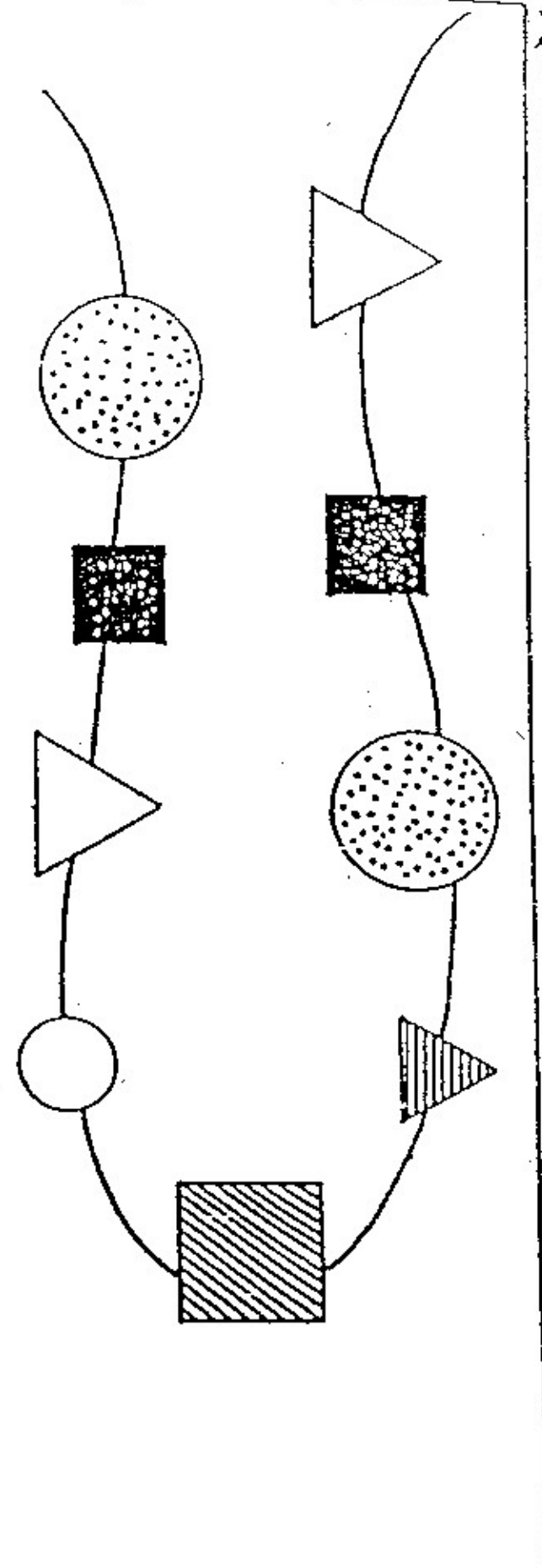

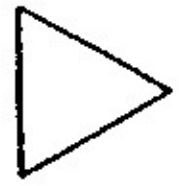
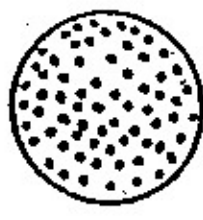
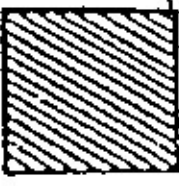

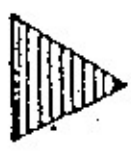
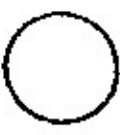
1

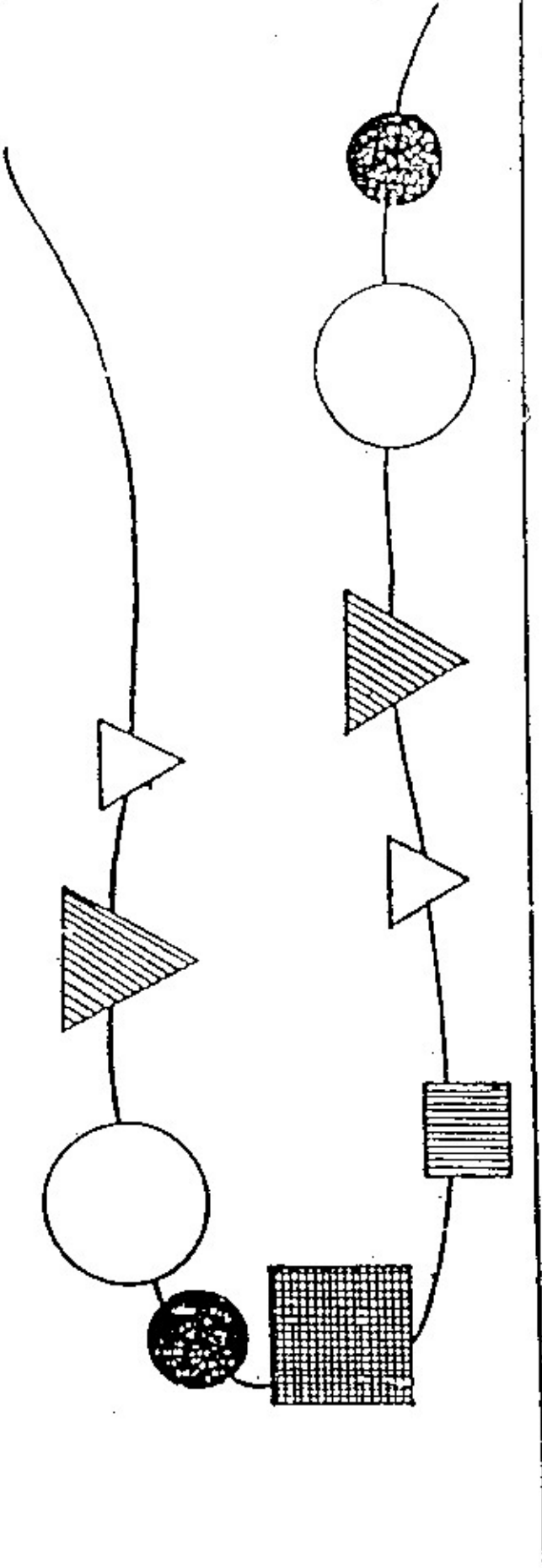

| | | | |
|---|---|---|---|
|  | U |  | ๑ |
|  | B |  | ๒ |
|  | A |  | ๓ |

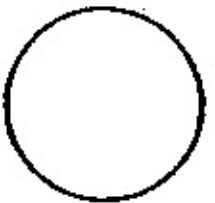

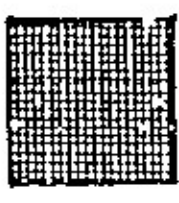

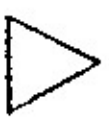

2

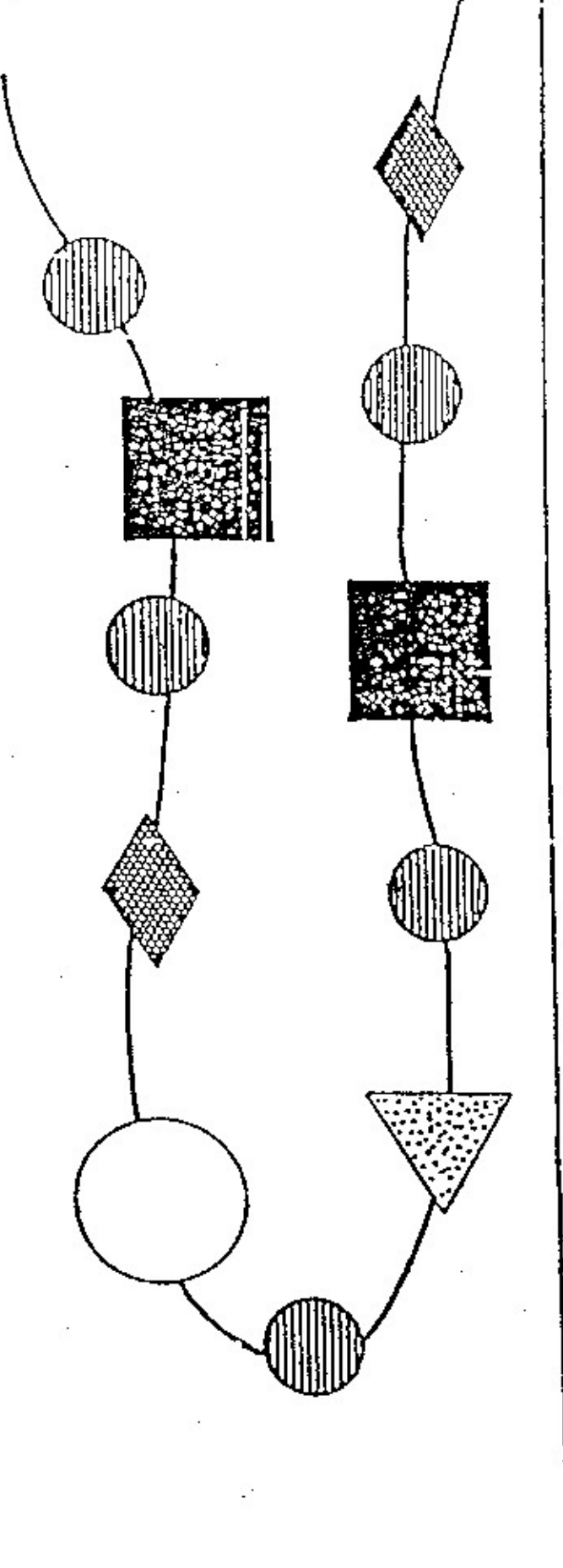

| | | | |
|---|---|---|---|
|  | U |  | ๑ |
|  | B |  | ๒ |
|  | A |  | ๓ |

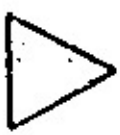
3

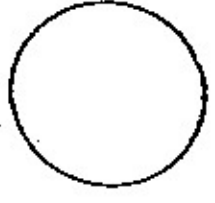

| | | | |
|---|---|---|---|
|  | U |  | ๑ |
|  | B |  | ๒ |
|  | A |  | ๓ |

