

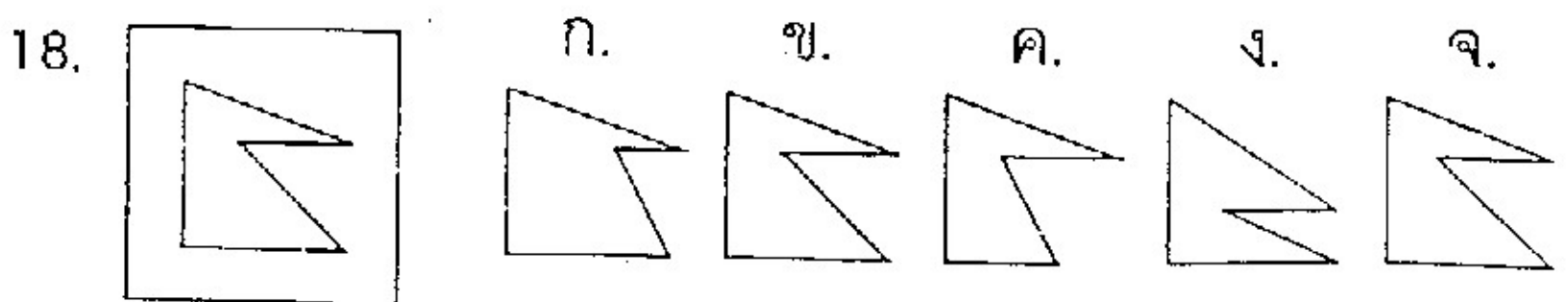

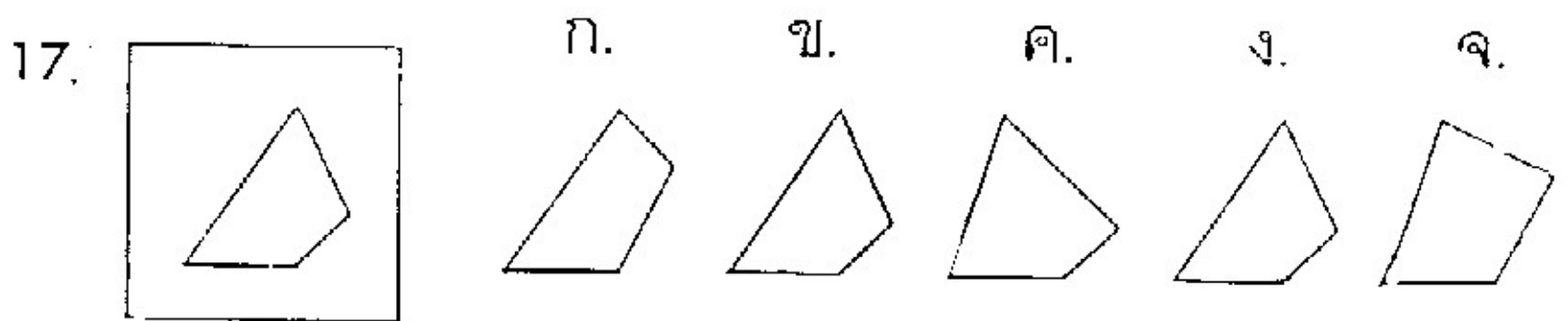

จับคู่รูปภาพ

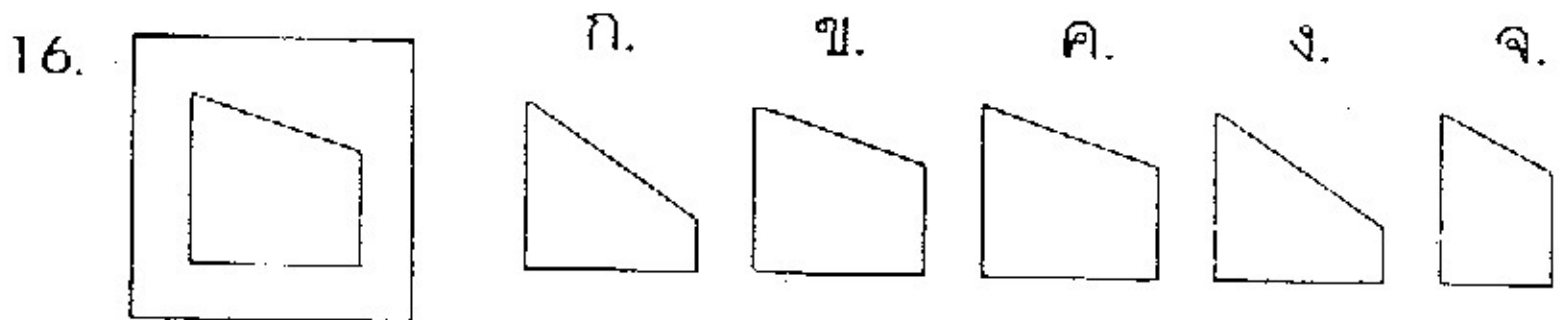
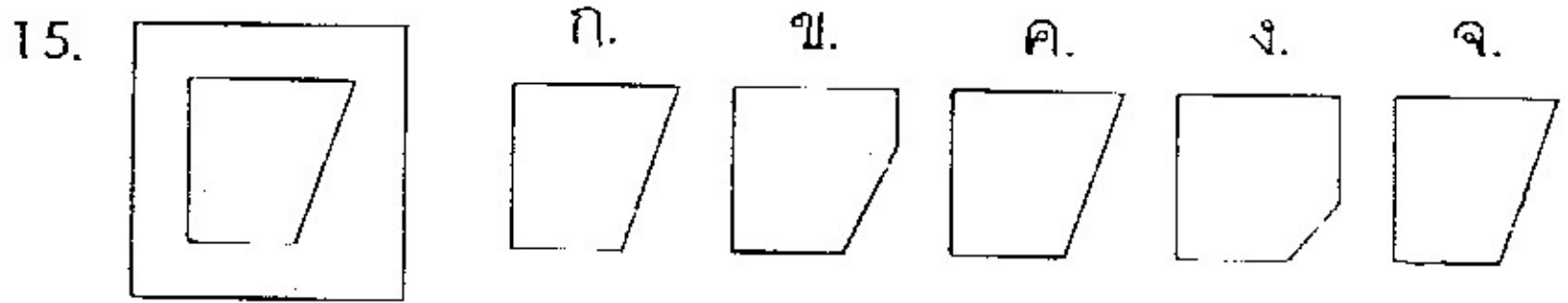
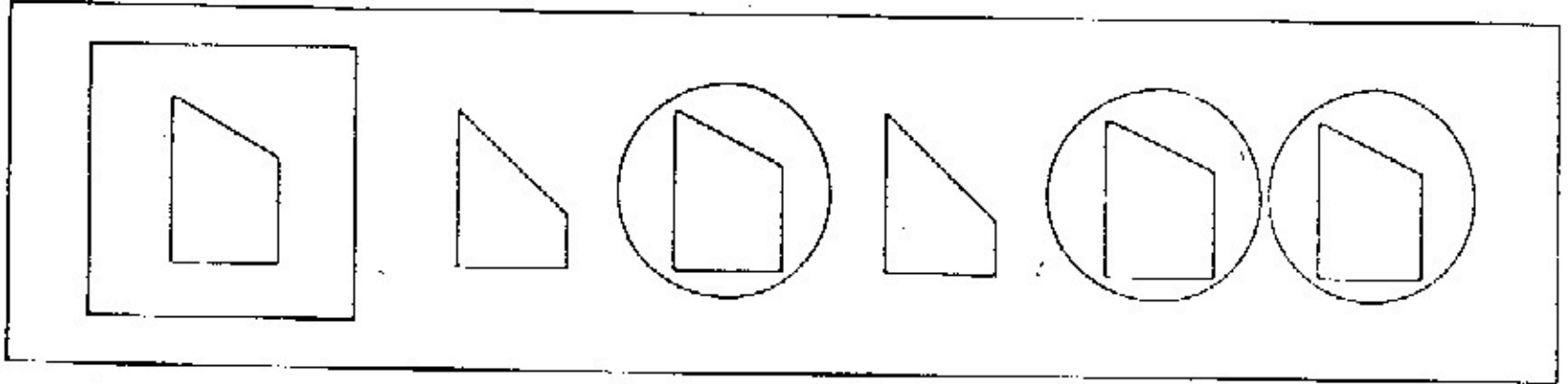

ดูรูปในกรอบสี่เหลี่ยม แล้วหารูปที่เหมือนกัน
วงกลมล้อมรอบรูปที่เป็นคู่กับรูปในกรอบทุกรูป
ตัวอย่าง

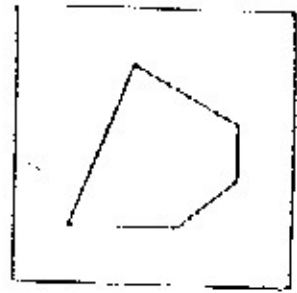
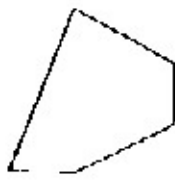
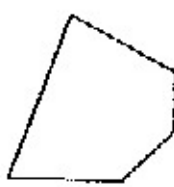

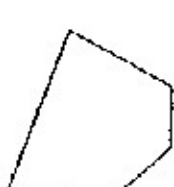



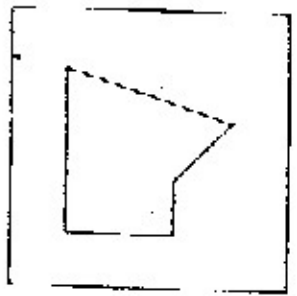
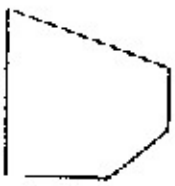
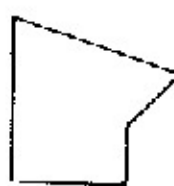
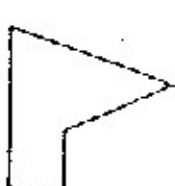
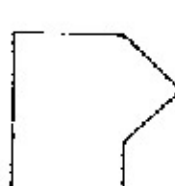



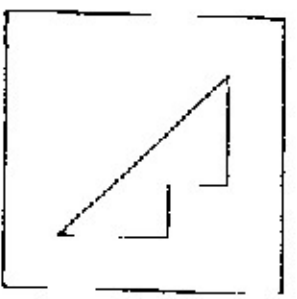
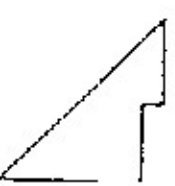

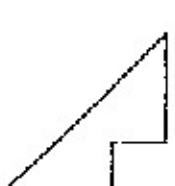
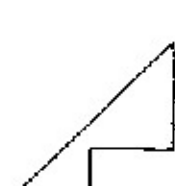
จับคู่รูปภาพ

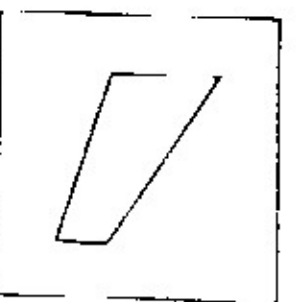

วงกลมล้อมรอบรูปที่เป็นคู่กับรูปในกรอบทุกรูป

19.  ก.  ข.  ค.  ง.  จ. 

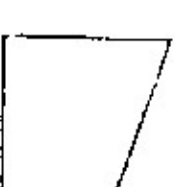
20.  ก.  ข.  ค.  ง.  จ. 

21.  ก.  ข.  ค.  ง.  จ. 

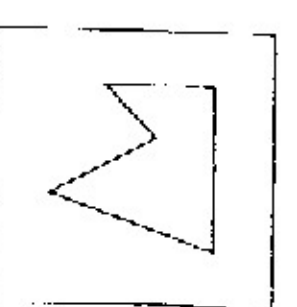
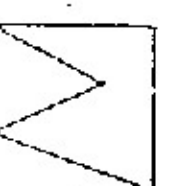
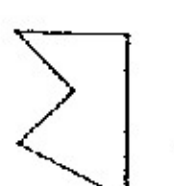
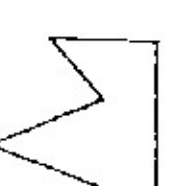
22.  ก.  ข.  ค.  ง.  จ. 

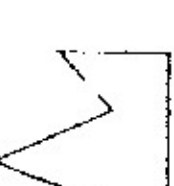
23.  ก.  ข.  ค.  ง.  จ. 

จับคู่รูปภาพ

วงกลมล้อมรอบรูปที่เหมือนกันในแต่ละแถว

ตัวอย่าง

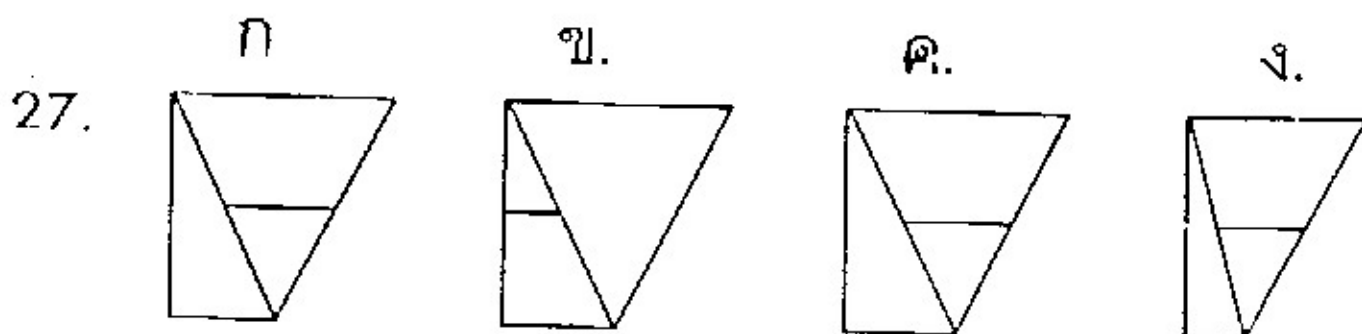
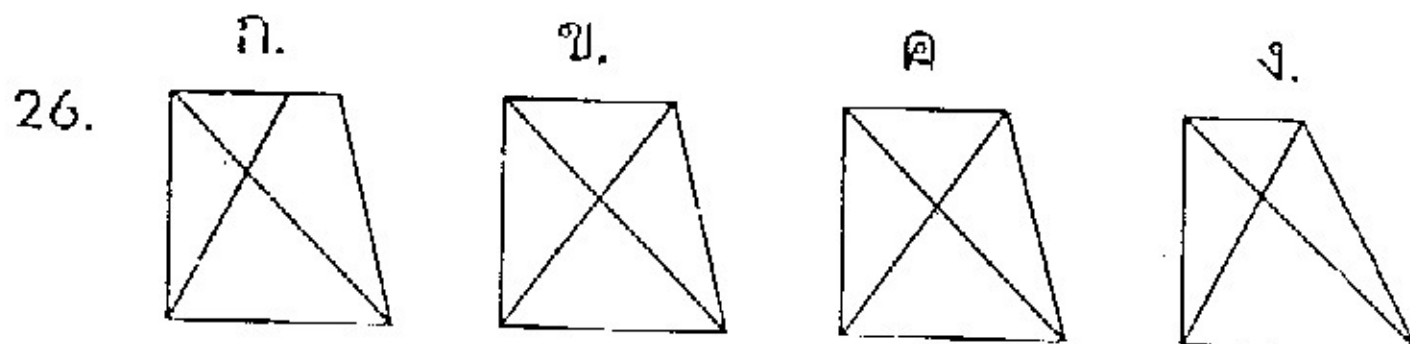
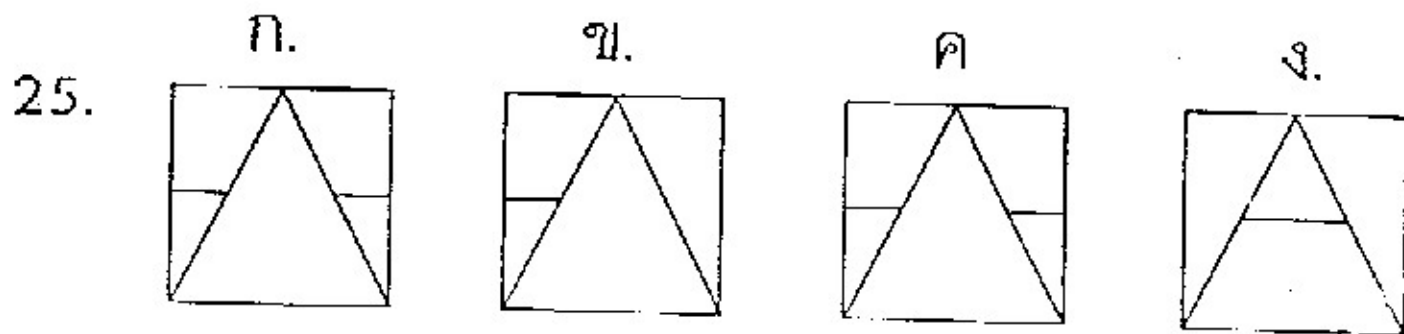
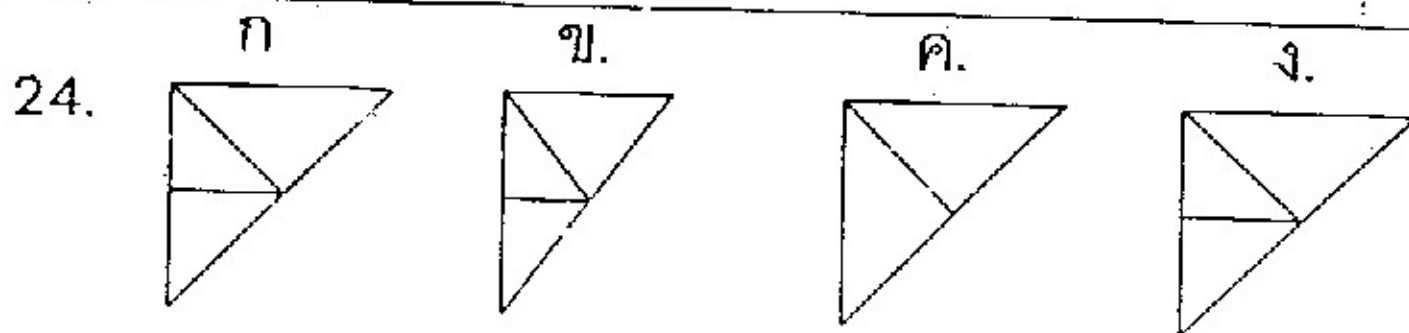
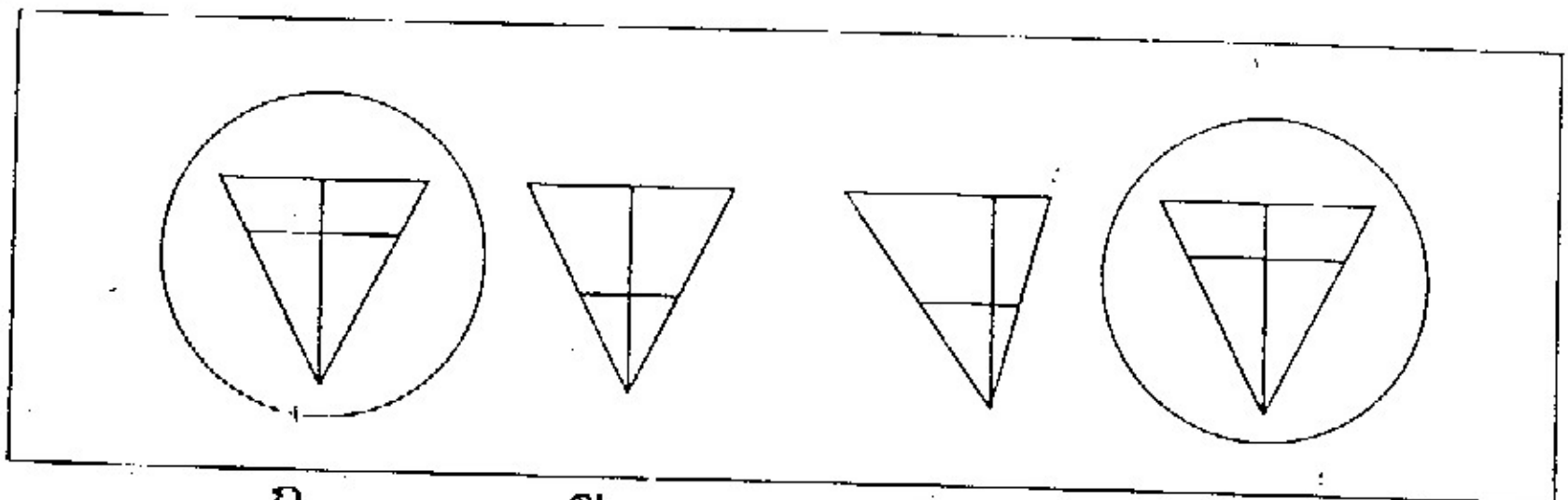

จับคู่รูปภาพ

วงกลมล้อมรอบรูปที่เหมือนกันในแต่ละแถว

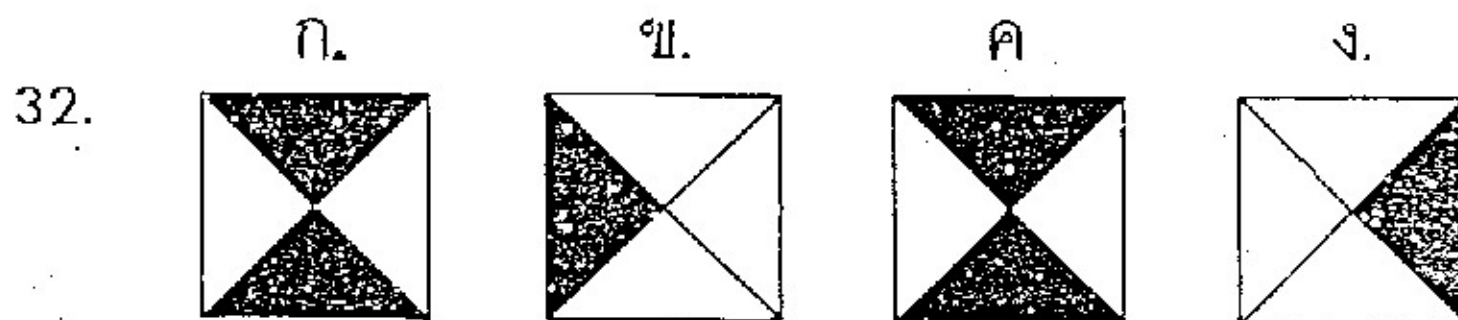
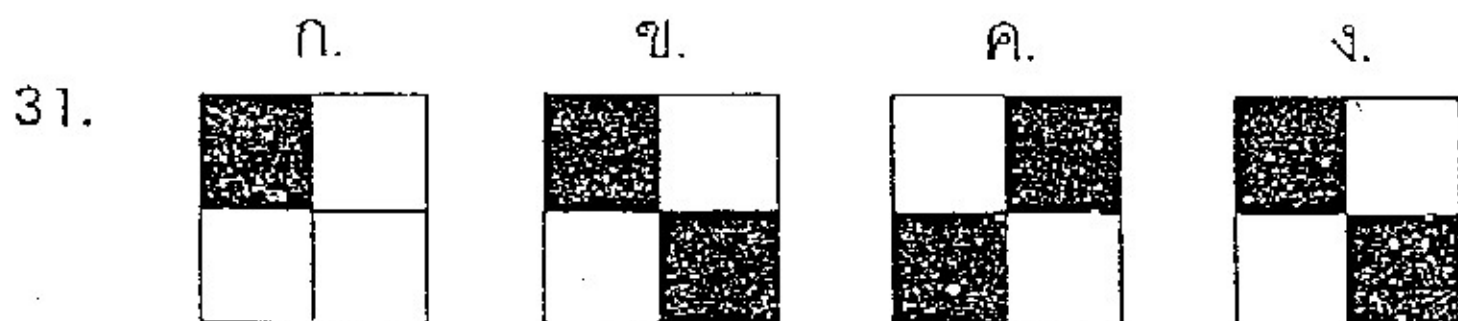
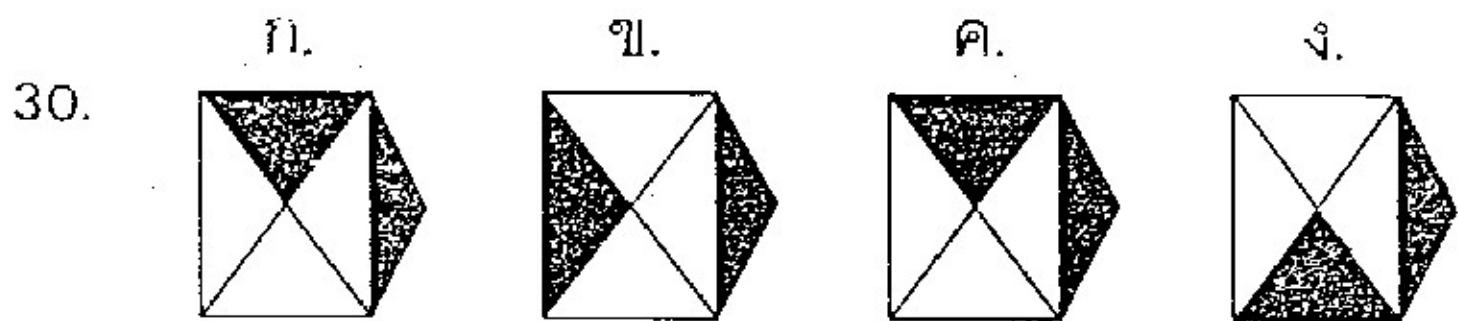
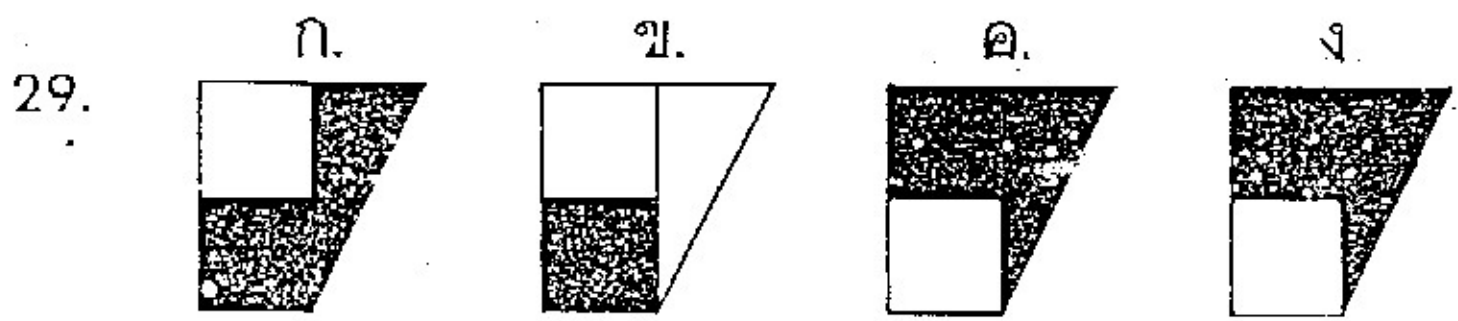
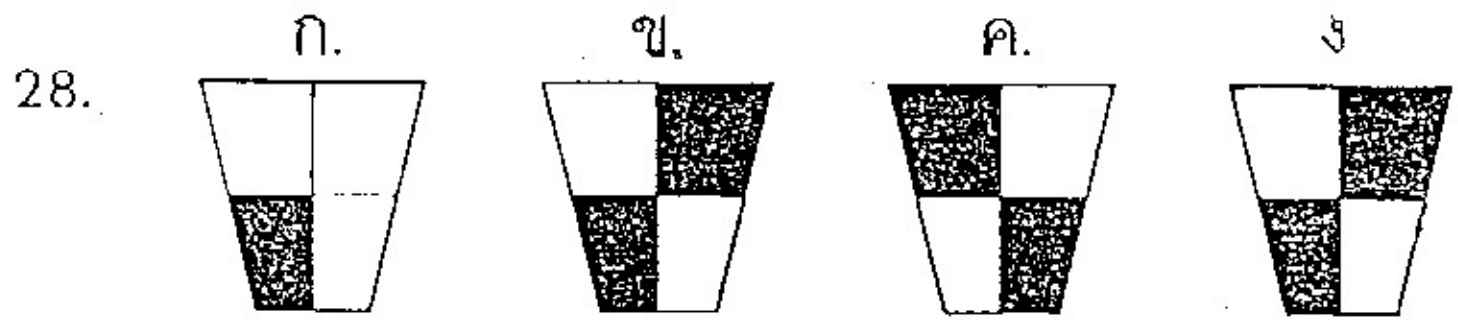

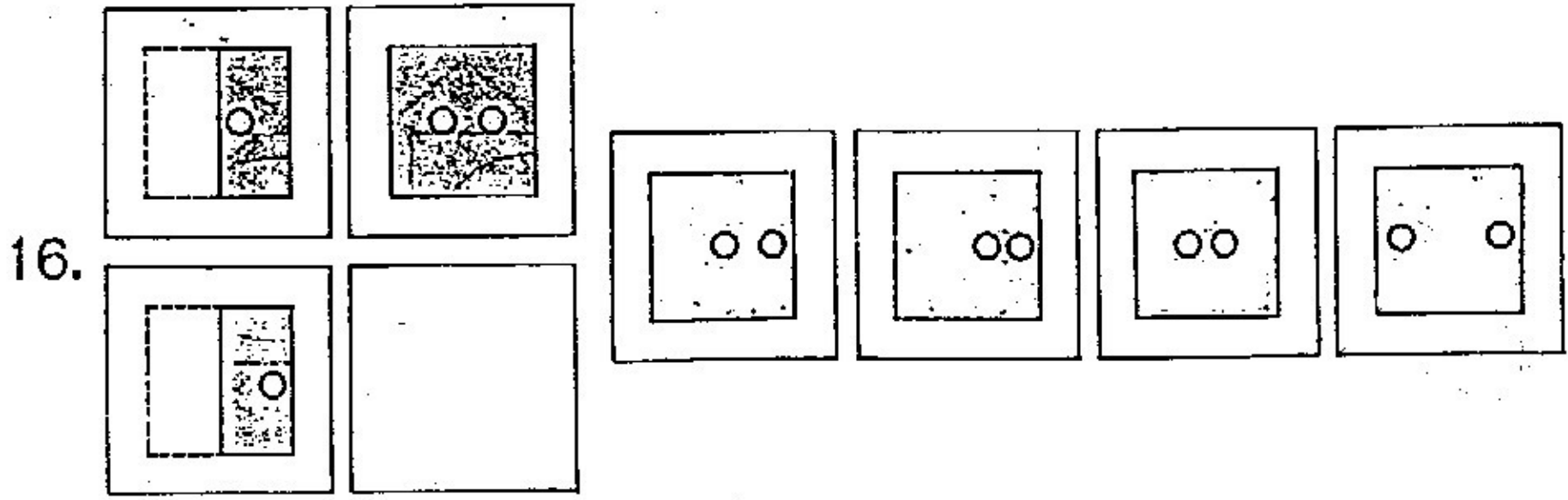
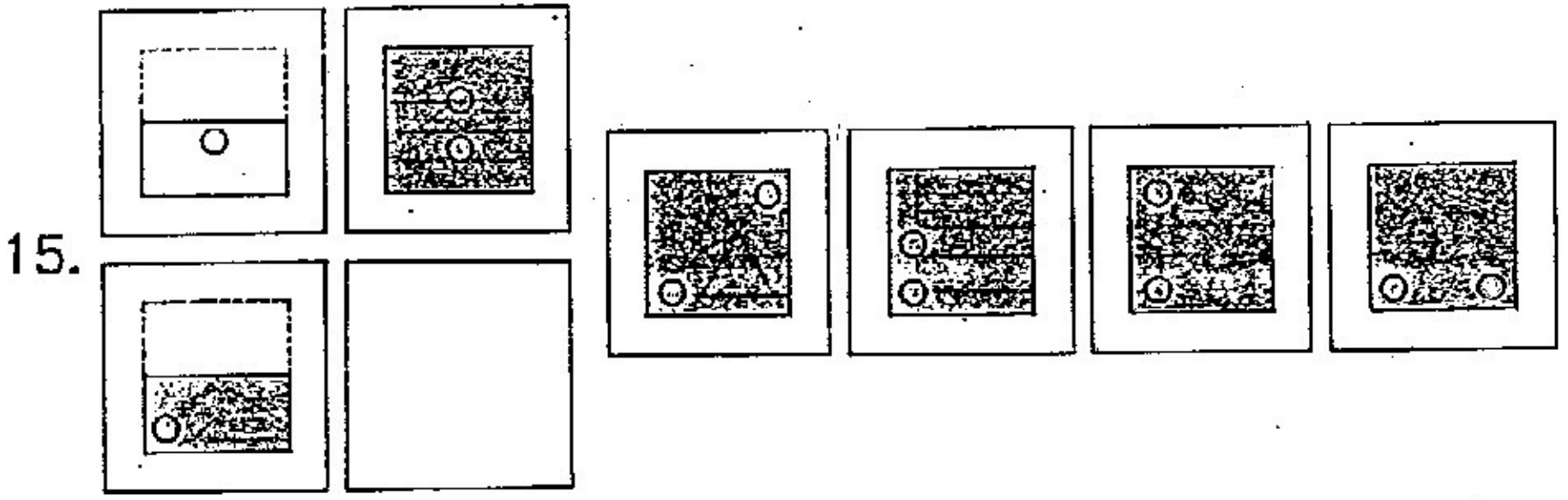
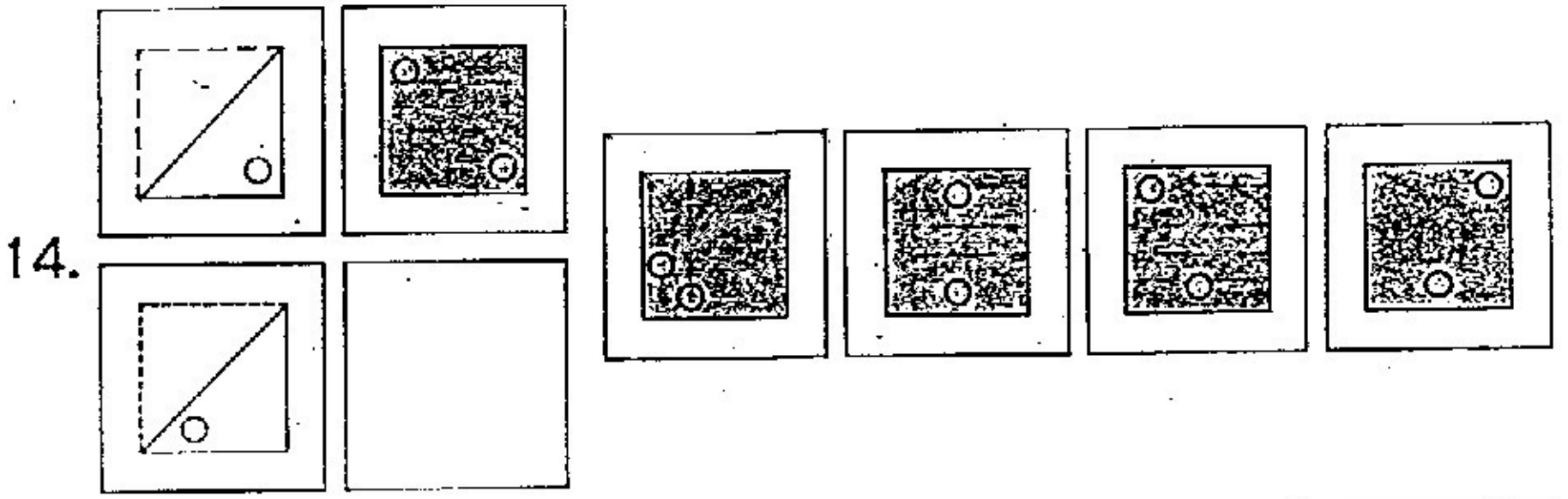
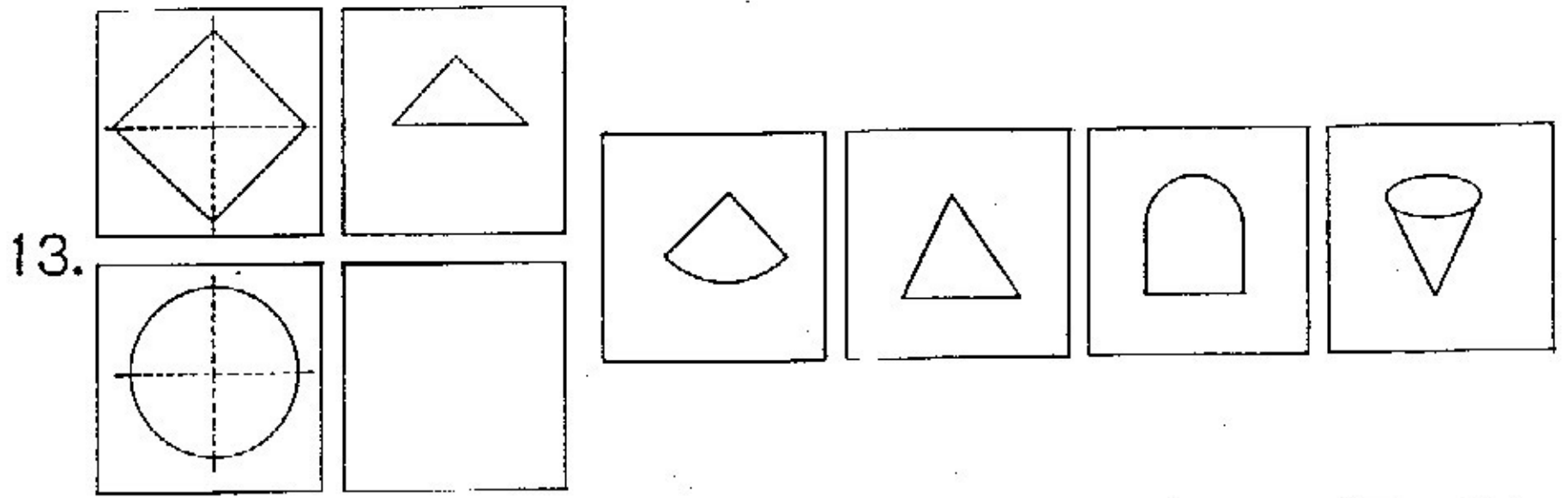

17.

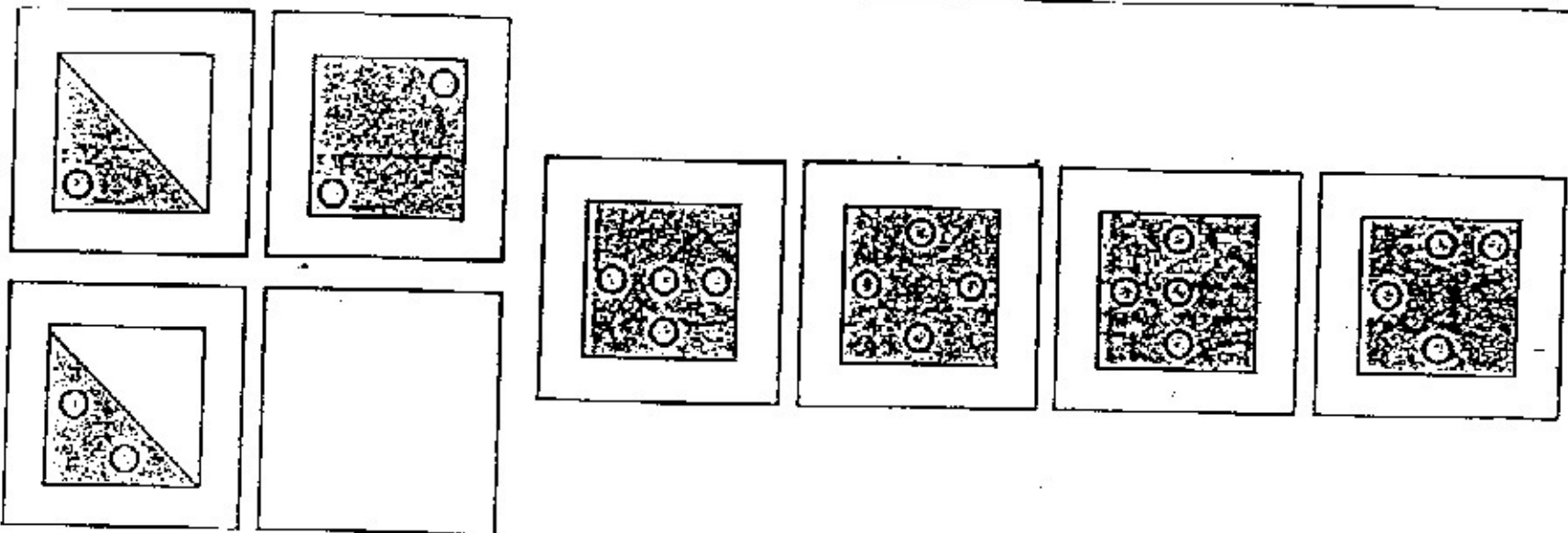

18.

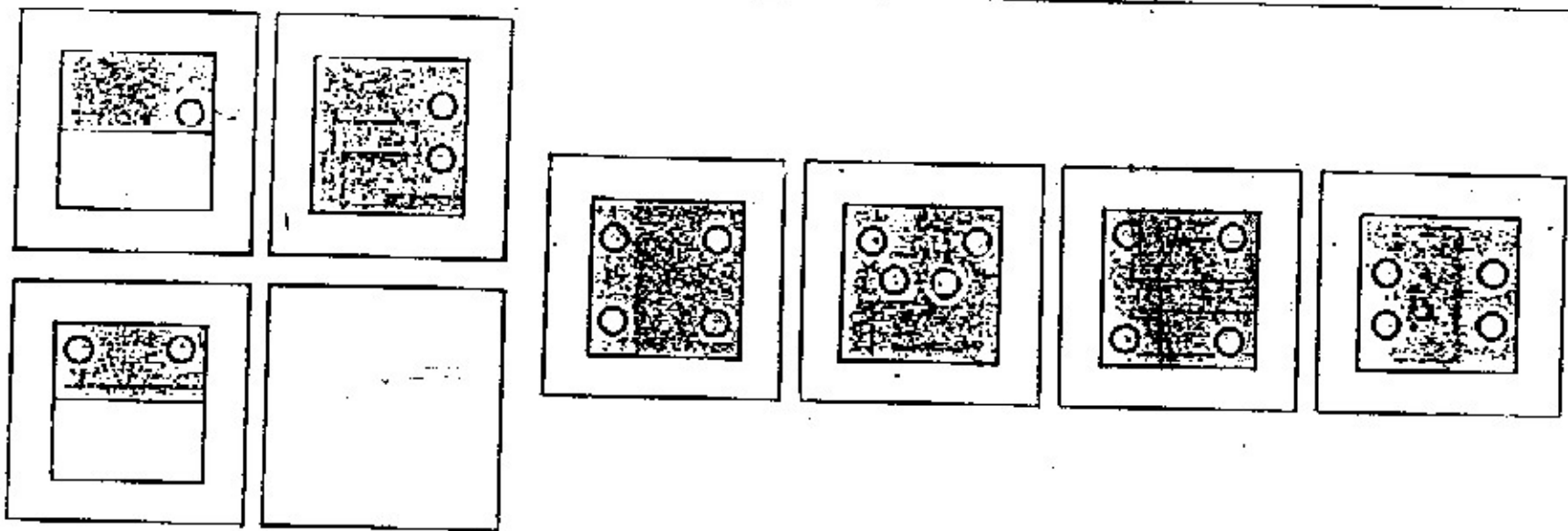



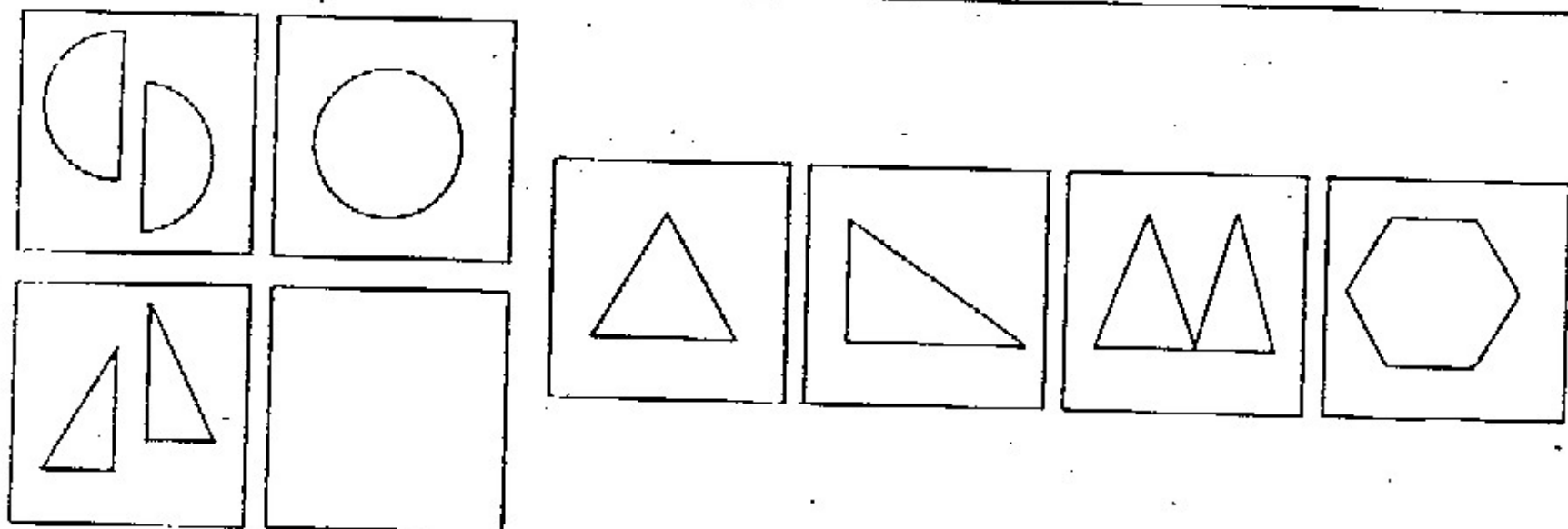



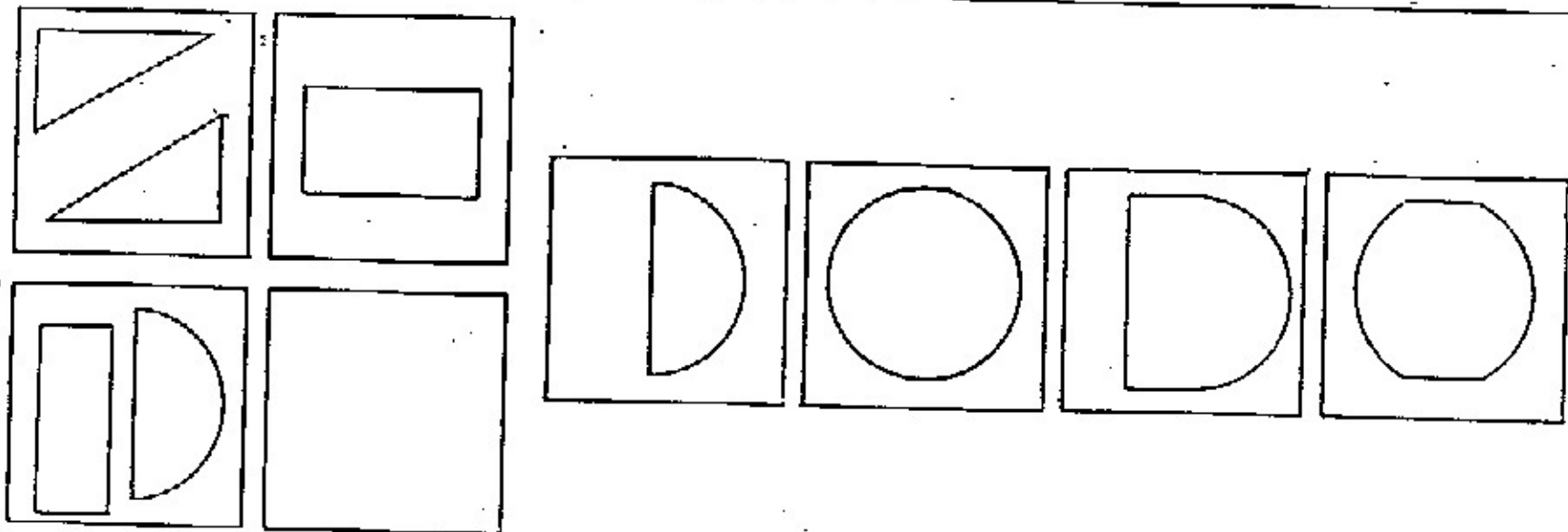

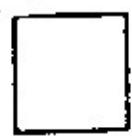

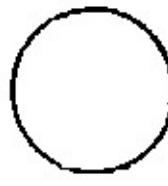
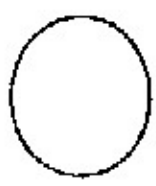

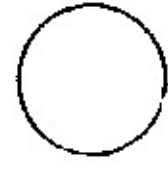
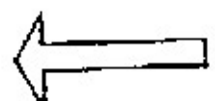



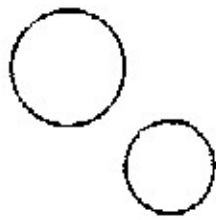
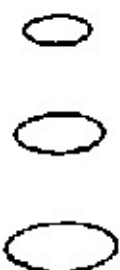
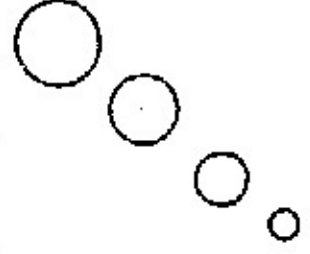
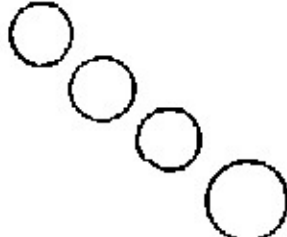
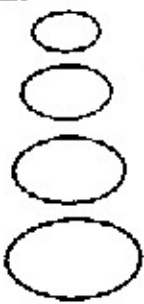
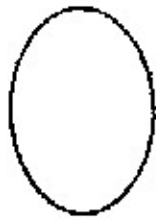
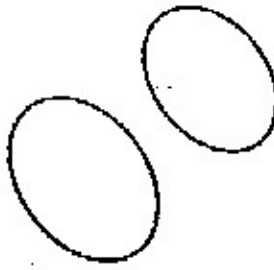







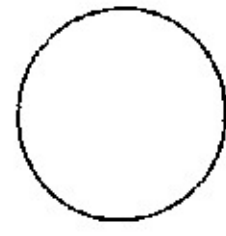

19.

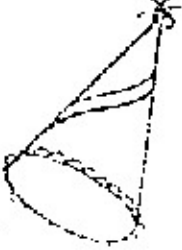

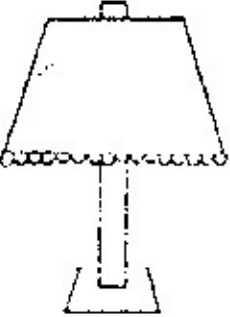





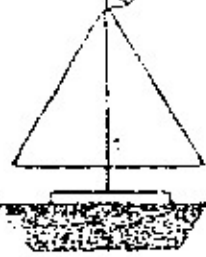

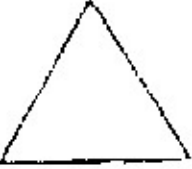
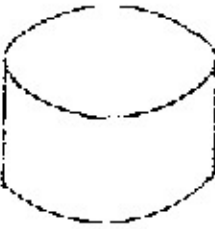
20.

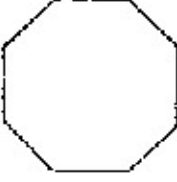
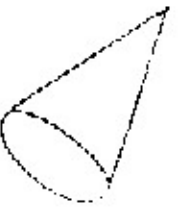

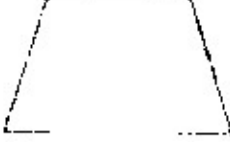
1	2	3	4
			
			
			
			
			
			
			

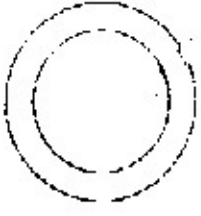
က.		ဃ.		ဂ.		ဃ.	
ခ.		ဂ.		ဃ.		ဃ.	
ဃ.		ဃ.		ဂ.		ဂ.	

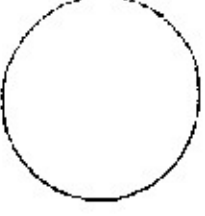
1		2 :		3 :		4 :	
5		6		7		8 :	
9		10		11 :		12 :	

ครูหรือผู้ปกครองอ่านแล้วให้นักทำ : (ให้เวลาทำข้อละประมาณ ๓๐ วินาที)

กิจกรรมเพิ่มเติม : หลังจากทดสอบแบบวัดความพร้อมชุดนี้แล้ว ให้ระบายสีภาพที่เป็นคำตอบ

ตัวอย่าง สัตว์ตัวไหนเอ๋ยที่เลี้ยงไว้เฝ้าบ้าน



ตัวอย่าง ถ้าต้องการตัดกระดาษจะใช้อะไรเอ๋ย

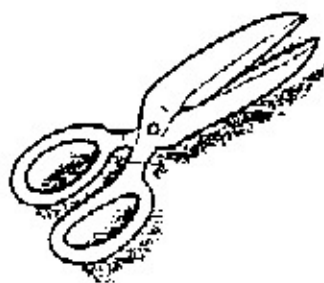
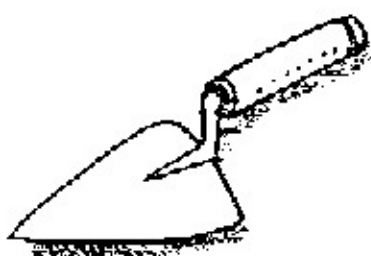

๑. นกตัวไหนเอ๋ยที่ชอบหากินตอนกลางคืน



๒. แมลงตัวไหนเอ๋ยที่น่าเชื่อโรคน่ากลัว

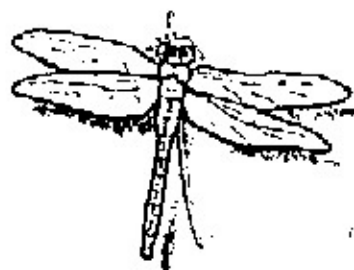

๓. เครื่องบินลำไหนเอ๋อที่บินได้เร็วที่สุด

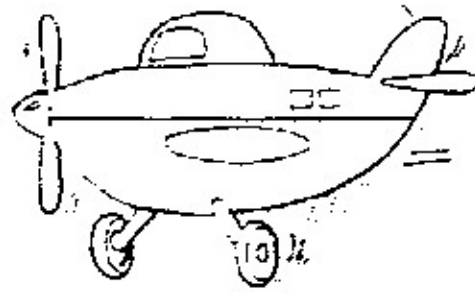
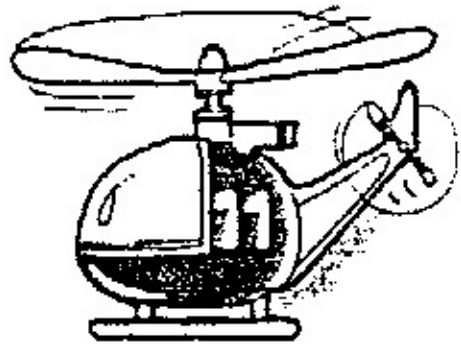

๔. สัตว์ตัวไหนเอ๋อที่มีในบ้านเรา



๕. ถ้าต้องการโบกปูนจะใช้อะไรเอ๋อ

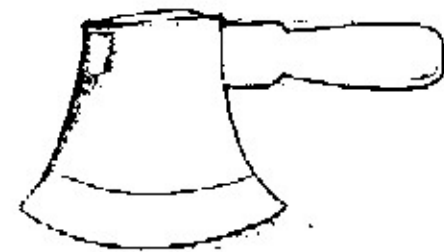
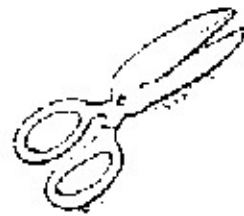

๖. สัตว์ตัวไหนเอ๋อที่เป็นตัวเมีย



๗. วันเกิดของคุณแม่ควรซื้ออะไรให้

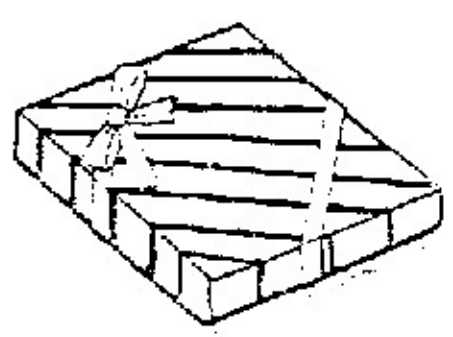

๘. สิ่งไหนเอ่ยเวลาเล่นต้องมีลมแรงๆ จึงจะดี

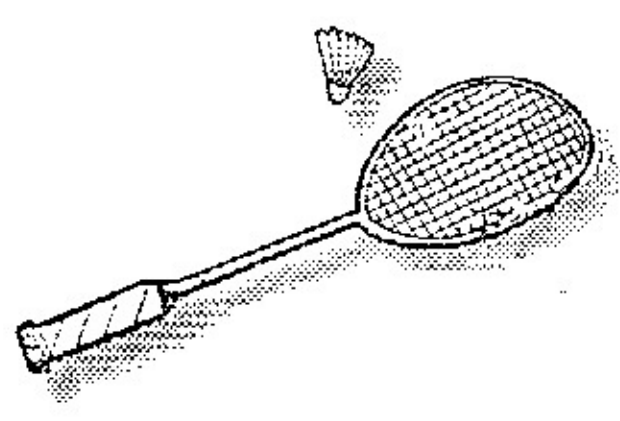
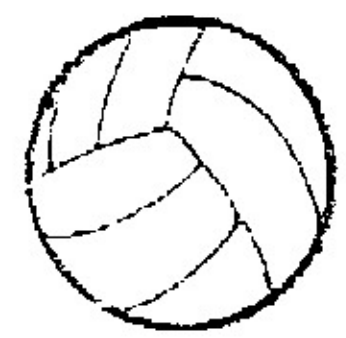
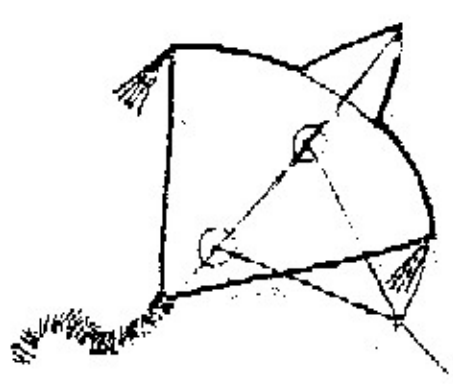



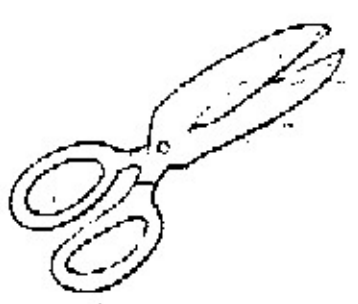

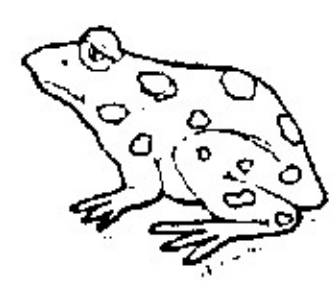
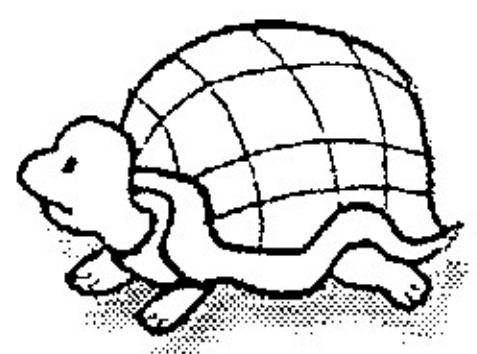
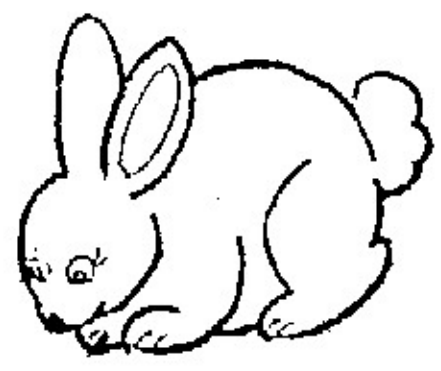

๙. นักเรียนไปโรงเรียนจะถืออะไรไป

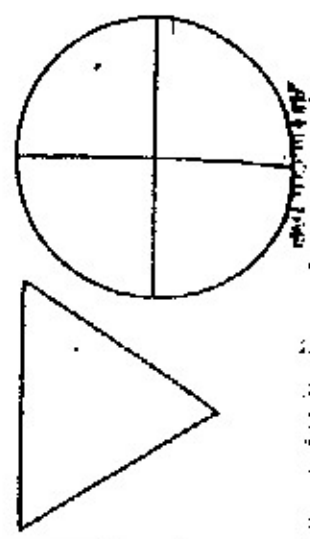
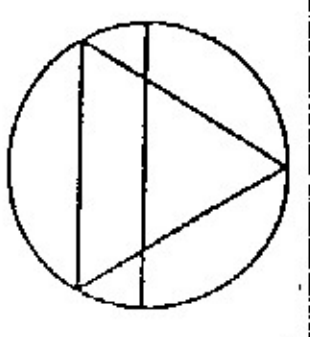
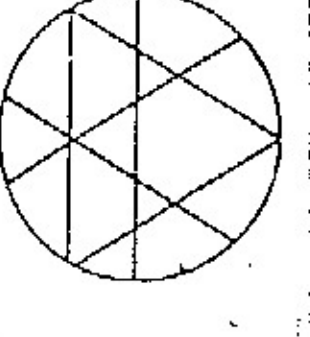
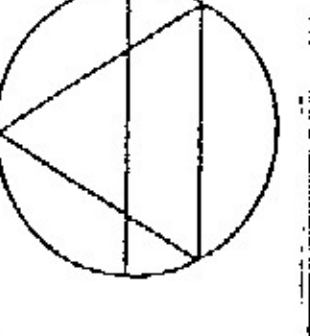
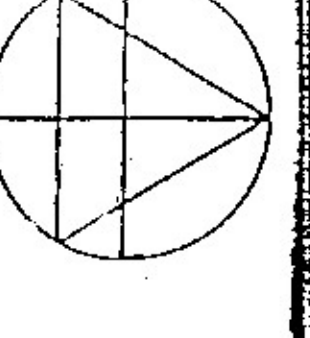
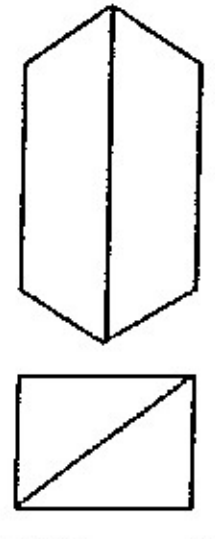
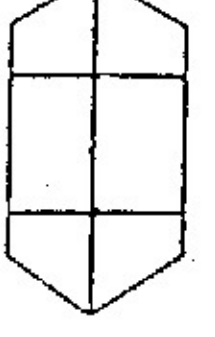
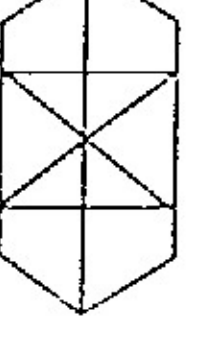
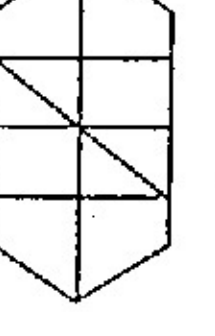
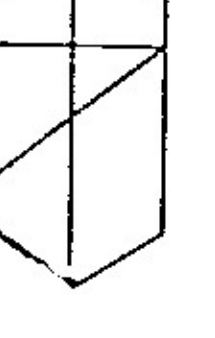
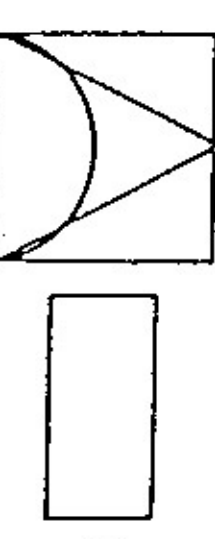

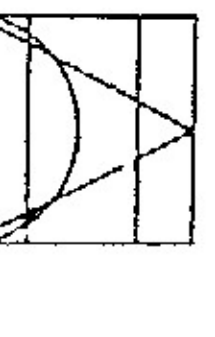
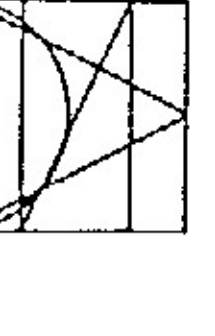
๑๐. สัตว์ตัวไหนเอ่ยอยู่ได้เฉพาะบนบกเท่านั้น

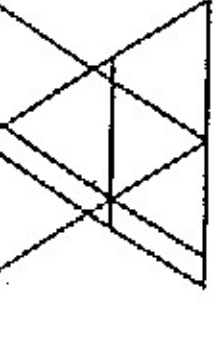
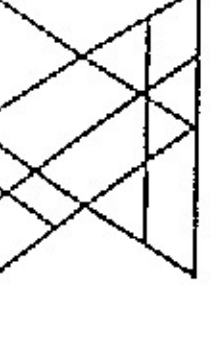
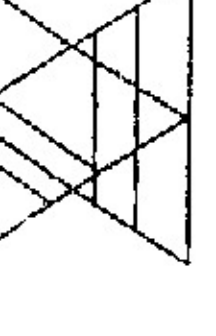
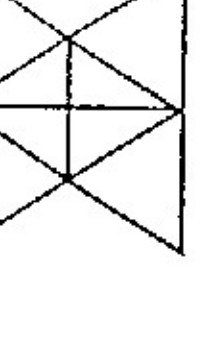
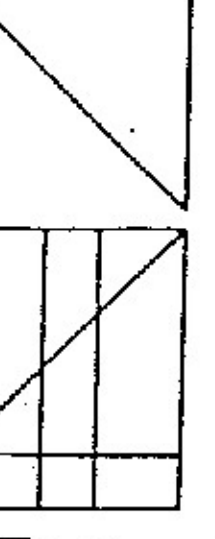

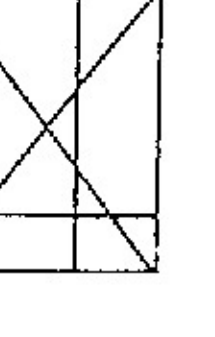
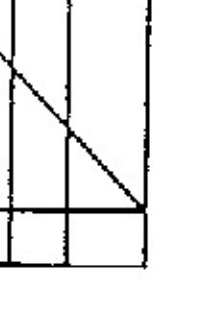
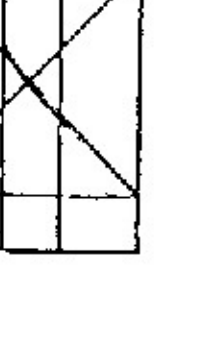
<p>1</p> 	 <p>U</p>	 <p>U</p>	 <p>A</p>	 <p>U</p>
<p>2</p> 	 <p>U</p>	 <p>U</p>	 <p>A</p>	 <p>U</p>
<p>3</p> 	 <p>U</p>	 <p>U</p>	 <p>A</p>	 <p>U</p>
<p>4</p> 	 <p>U</p>	 <p>U</p>	 <p>A</p>	 <p>U</p>
<p>5</p> 	 <p>U</p>	 <p>U</p>	 <p>A</p>	 <p>U</p>

6

7

8

9

10

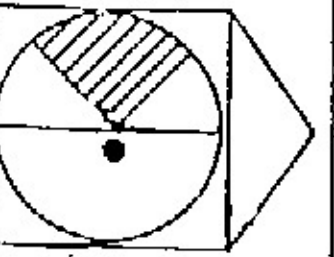
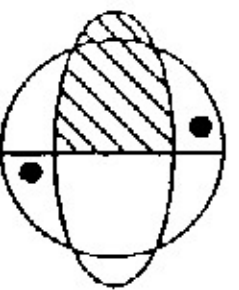
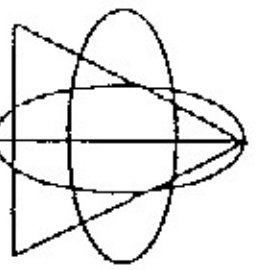
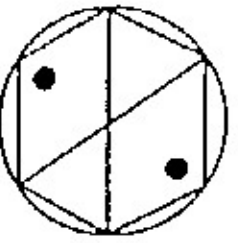
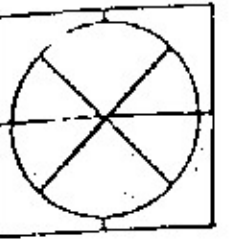
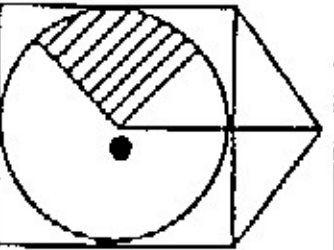
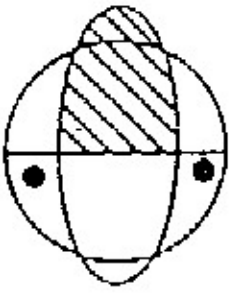
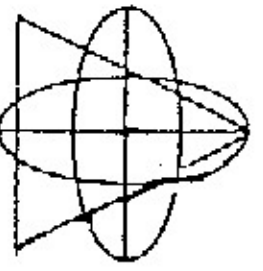
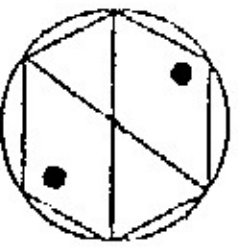
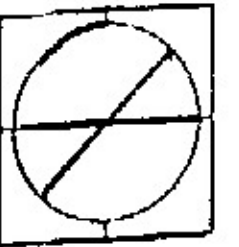
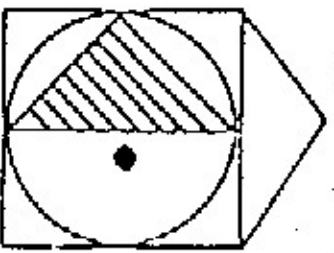
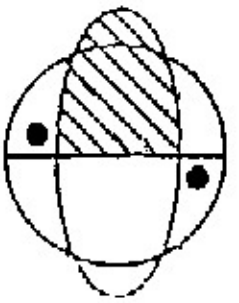
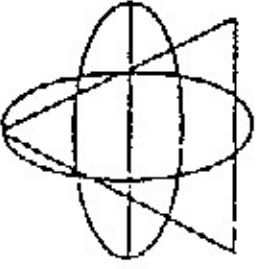
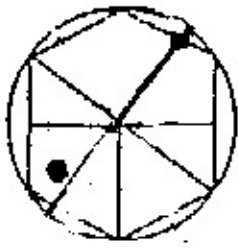
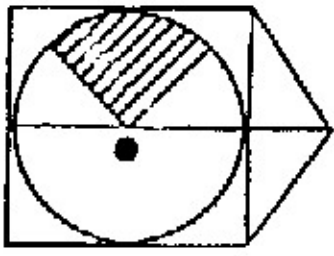
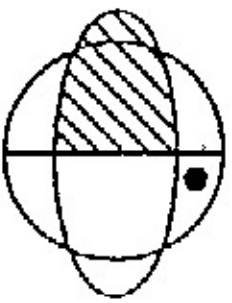
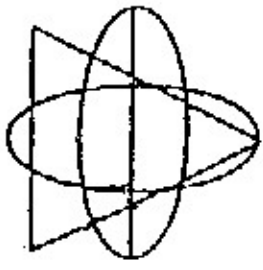
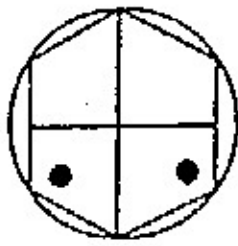
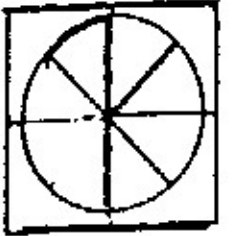
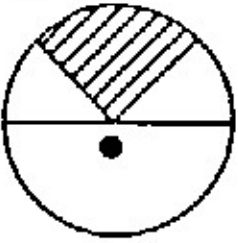
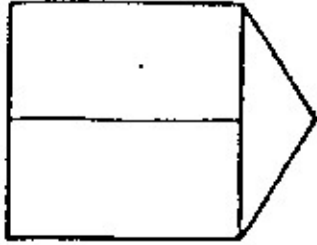
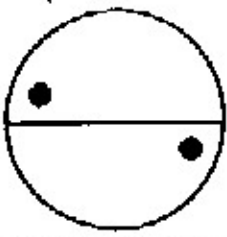
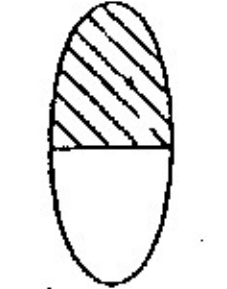
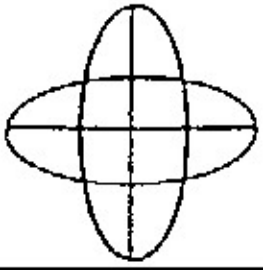
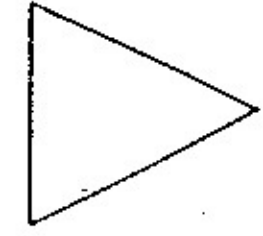
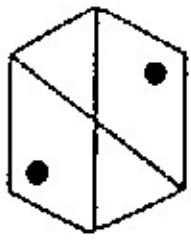
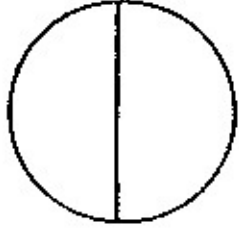
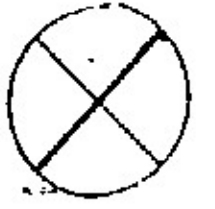
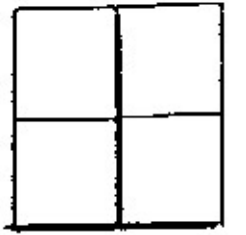

U

U

U

U

U

U

U

U

U

U

U

U

U

U

U

U

U

U

U

U

ครูเล่าเหตุการณ์ให้นักเรียนฟังแล้วให้นักเรียนเขียนเลข 1, 2, 3 ลงในช่อง

เรียงความลำดับเหตุการณ์

ตัวอย่าง

ถ้ารถไฟเคลื่อนที่ลงการหนีบดินธออกจากกระเป๋าทะลุเหตุการณ์ควรจะเป็นอย่างไร

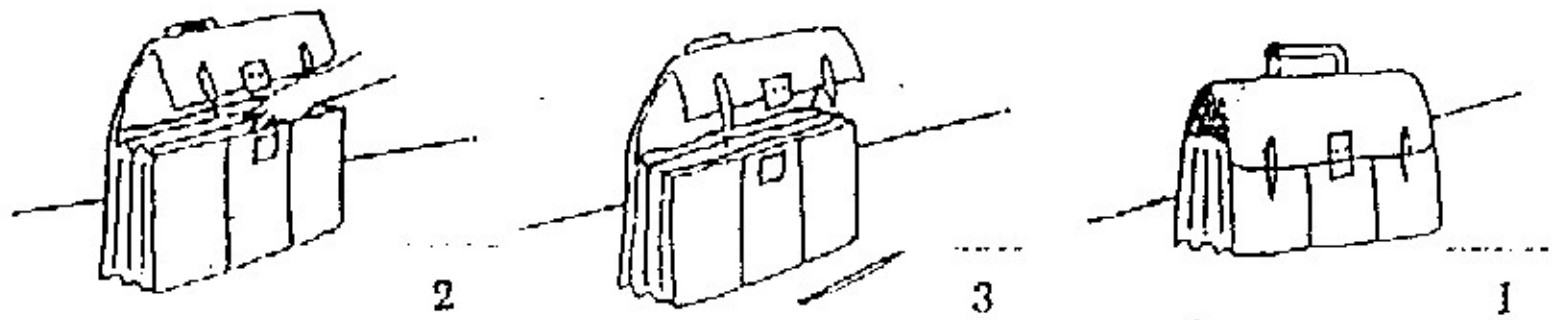

1. นักกีฬาที่กำลังเล่นฟุตบอลและเตะลูกบอลเข้าประตู ลำดับเหตุการณ์ควรเป็นอย่างไร

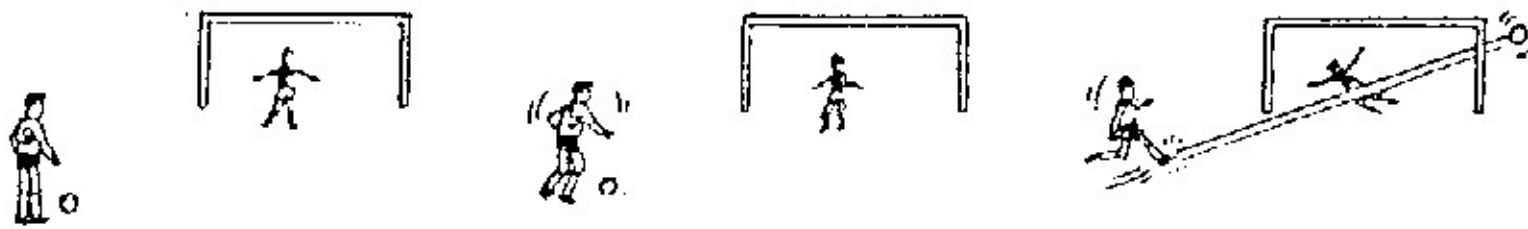

2. เมื่อนักเรียนสวมถุงเท้าและรองเท้าก่อนมาโรงเรียน ลำดับเหตุการณ์ควรเป็นอย่างไร



3. เมื่อนักเรียนต้องการจุดไม้ขีดไฟ ภาชนะเหตุการณ์ควรเรียงลำดับอย่างไร

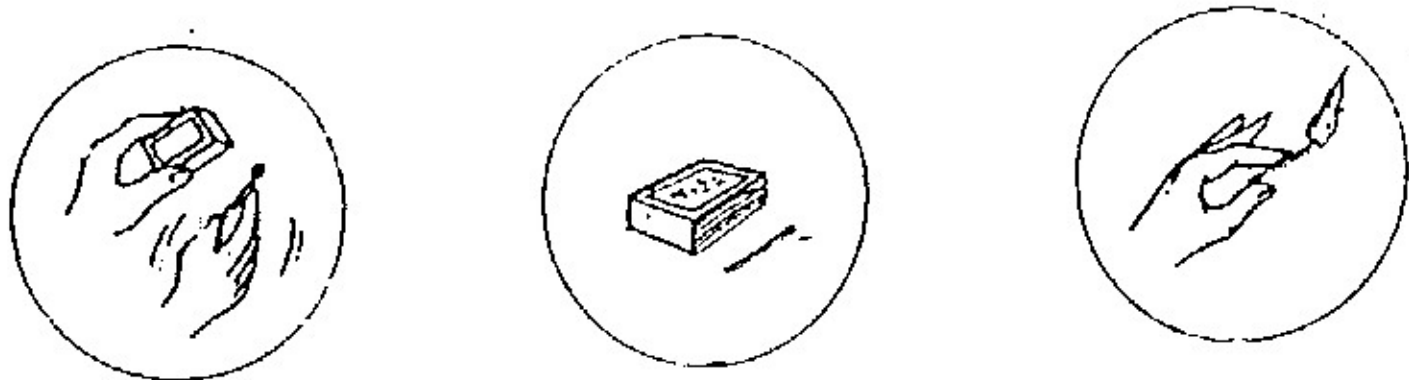

4. เมื่อนักเรียนกำลังรับประทานชมพู่ ภาชนะเหตุการณ์ควรเป็นอย่างไร



5. ถ้านักเรียนกำลังเหวี่ยงดินสอ ควรเรียงลำดับเหตุการณ์อย่างไร

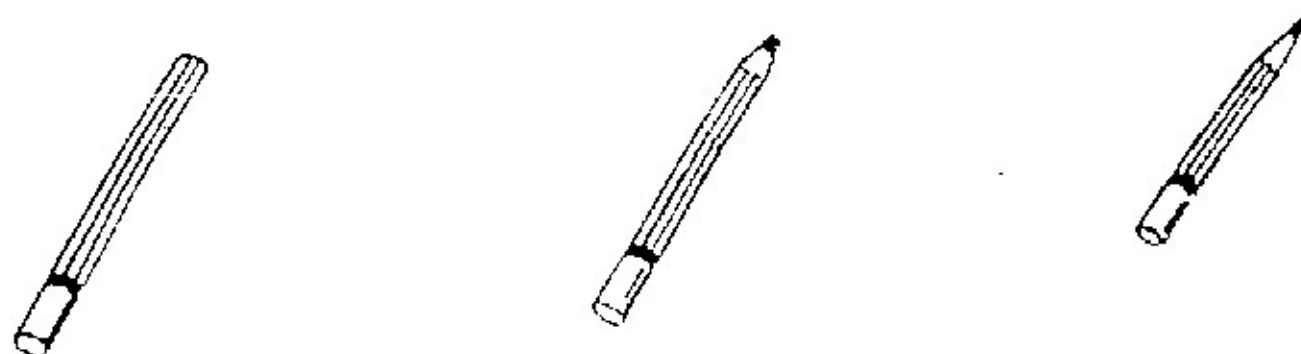

๕. เมื่อกันไม้เริ่มขึ้นเจริญเติบโตเต็มที่ ลำต้นเหตุการณ์ควรเป็นอย่างไร



๖. เมื่อกันกรีนเนไปตลอดไม้ตั้งแต่ดูจนงามเต็มที่ การจัดลำดับก่อน-หลัง ได้อย่างไร



๘. พิกัดตั้งกรรอกน้ำใส่ขวดจนเต็ม ลำดับเหตุการณ์ที่เกิดขึ้นควรเป็นอย่างไร

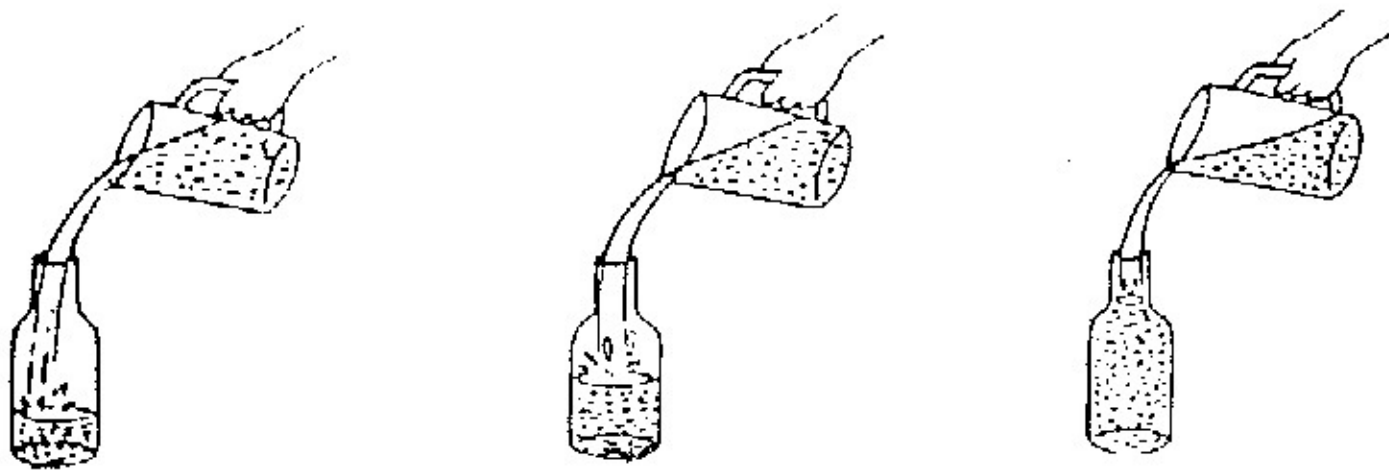

๘. เมื่อกระรอกวิ่งหนีงูได้ต้นไม้เข้าไปซ่อนในโพรง ควรเรียงลำดับภาพได้อย่างไร

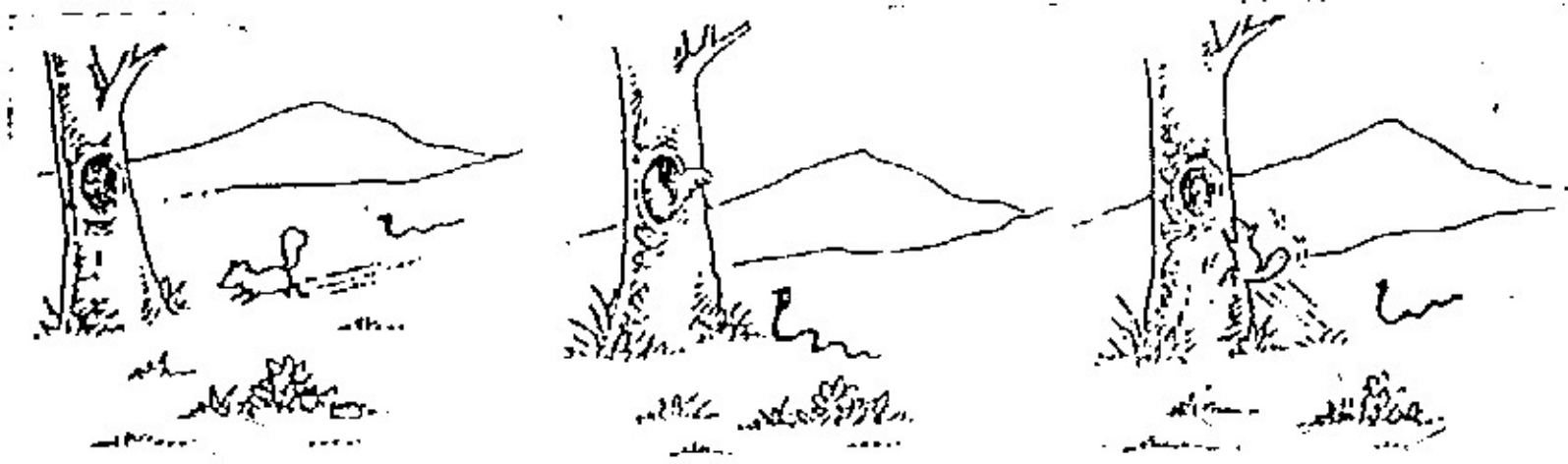

10. มีนักเรียนกำลังสวมเสื้อจะมารอโรงเรียน เหตุการณ์ที่เกิดขึ้นควรเรียงลำดับอย่างไร

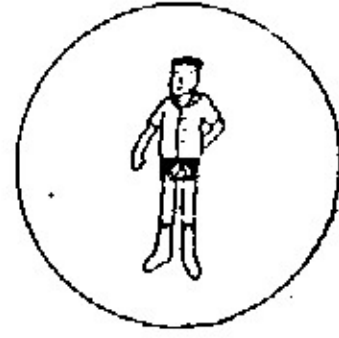
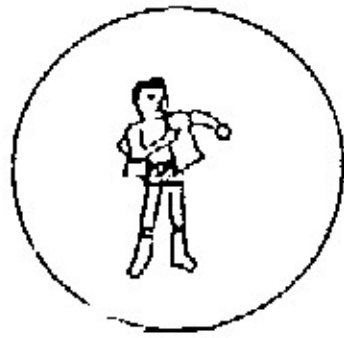

11. แมววิ่งไล่จับหนู ควรเรียงลำดับเหตุการณ์อย่างไร

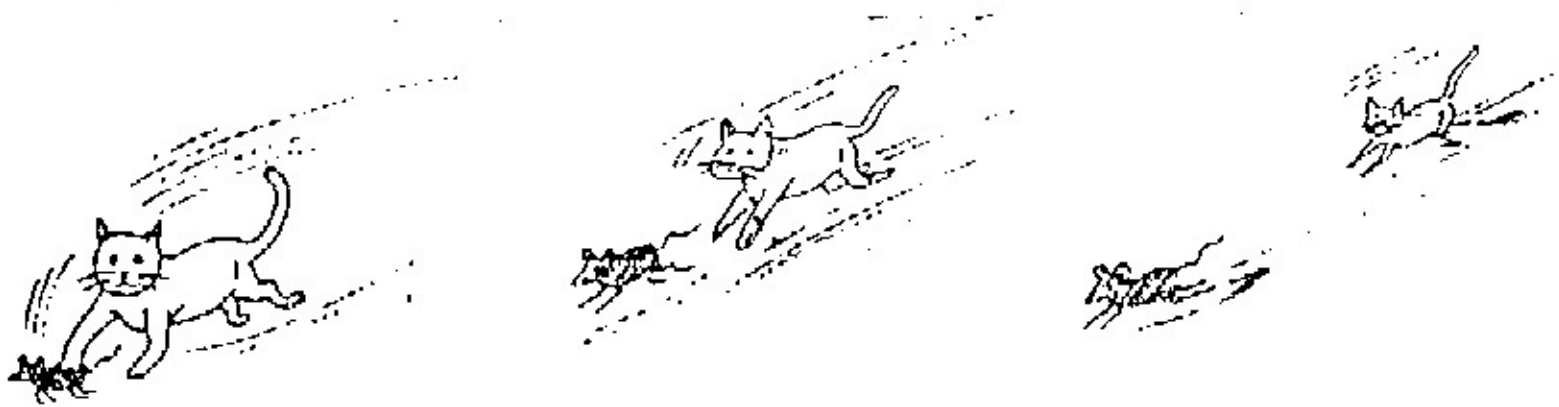

12. เมื่อนักเรียนโยนไม้ให้หมาวิ่งไปคาบมาให้ ถ้าสุนัขเหตุการณ์ควรเป็นอย่างไร



13. นักกีฬาดื่มน้ำจากแก้วหลังจากเล่นกีฬาเสร็จใหม่ๆ ภาวะเหตุการณ์ ก่อน- หลัง ของน้ำในแก้ว ควรเรียงลำดับอย่างไร



14. ทิวาตรูปวิวทะเล ควรจัดลำดับอย่างไรดี

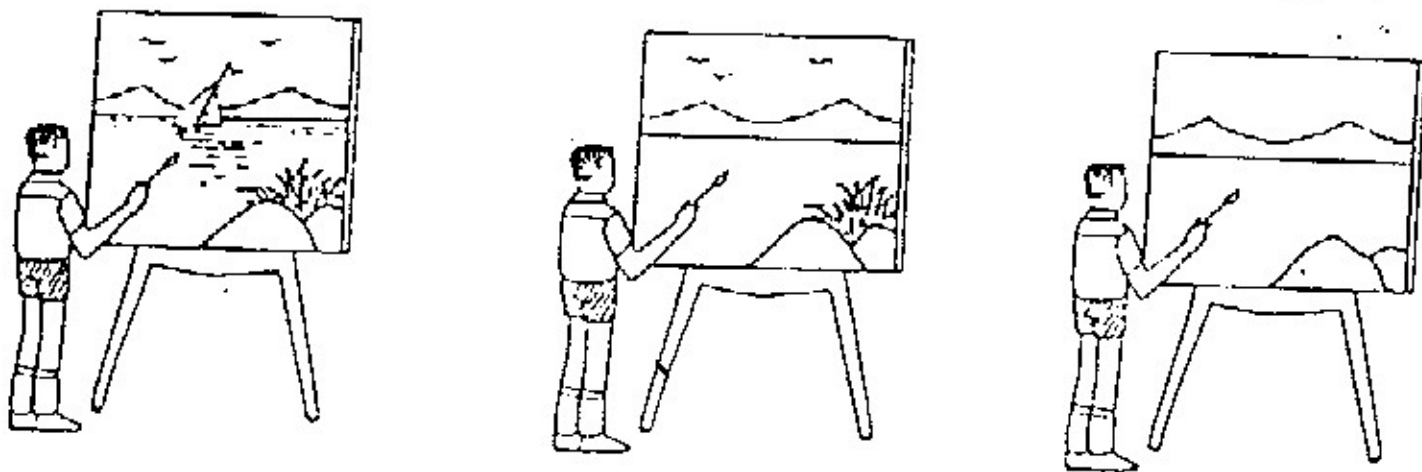

15. ลูกไก่ออกจากไข่ กวรวเรียงลำดับเหตุการณ์ที่เกิดขึ้นอย่างไร

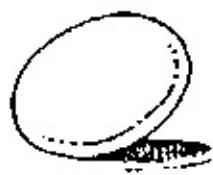

16. นักเรือบเป่าลูกโป่งแข่งกับเพื่อน สภาพของลูกโป่งควรวเรียงลำดับอย่างไร



17. น้องกำลังรับประทานไอศกรีมอย่างเอร็ดอร่อย ภาพเหตุการณ์ควรเป็นอย่างไร



18. ภาวะที่ออกองไฟที่ชายหาด ตั้งแต่เริ่มต้มนจนเป็นกองไฟ กววล่าดับ—
เหตุการณ์อย่างไร

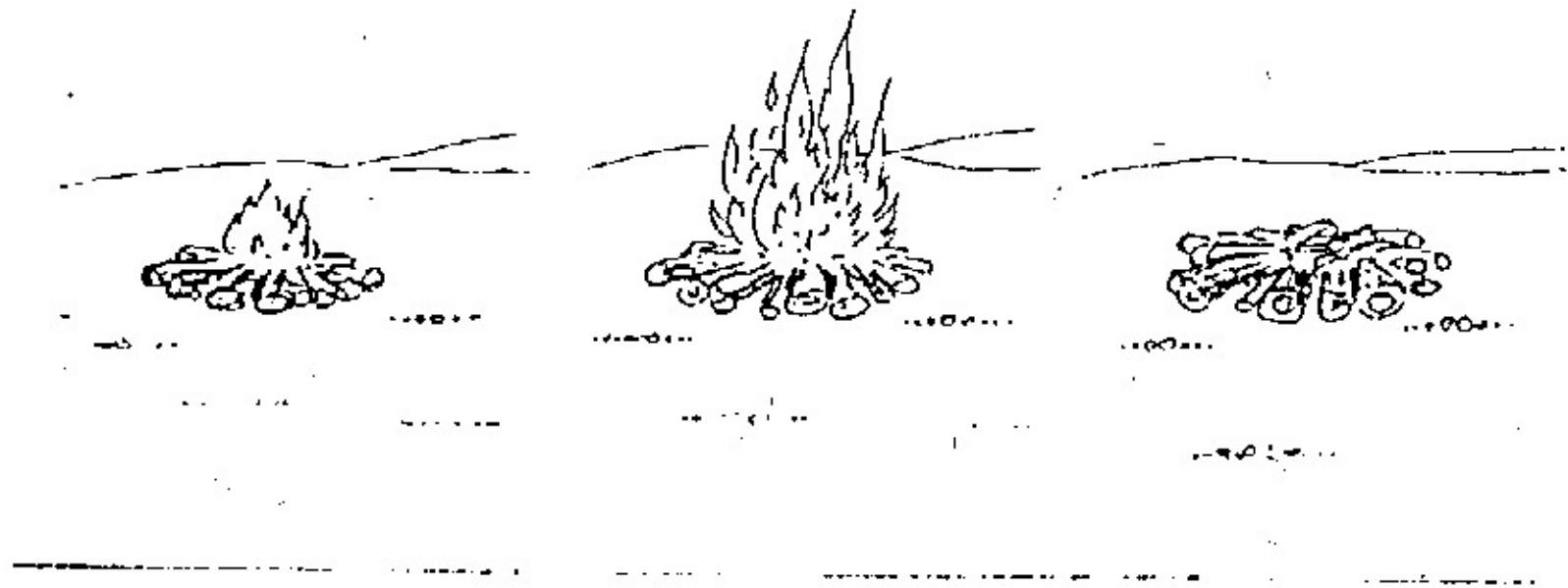

19. ภาวะแม่ต้มน้ำเพื่อชงนม ภาพเหตุการณ์ตั้งแต่เริ่มต้มนน้ำเดือด กวว —
จัดลำดับอย่างไร

