

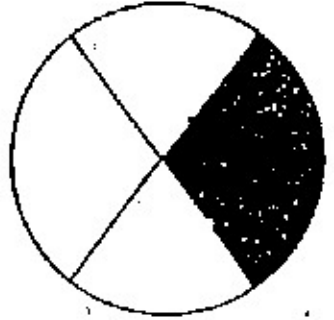

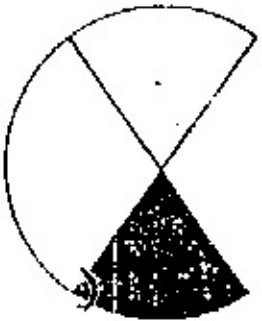

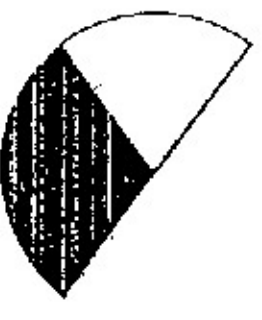

ภาพที่ต่อเนื่อง

1

			
			
<p>U</p>	<p>R</p>	<p>F</p>	<p>L</p>

2

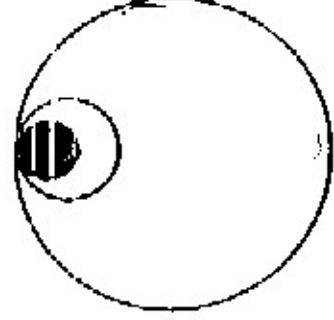
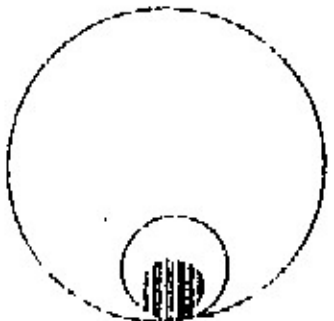
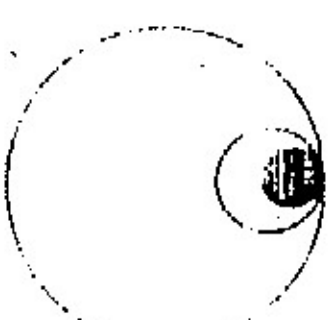
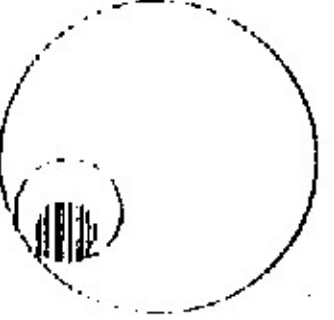
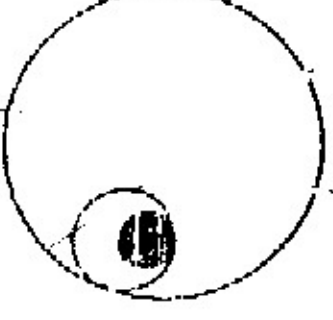
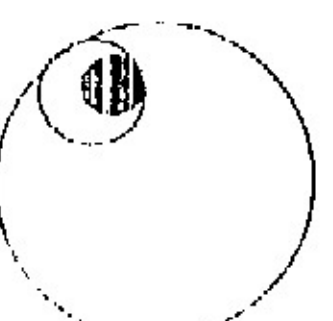
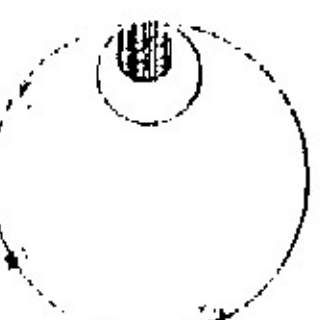
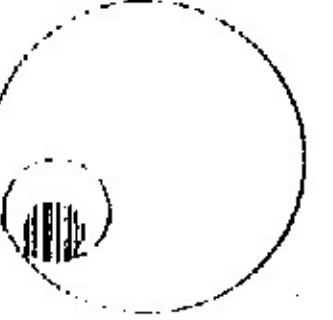
			
			
<p>152</p>	<p>152</p>	<p>152</p>	<p>152</p>

3

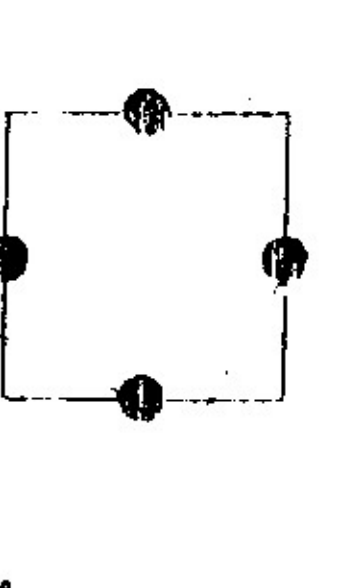
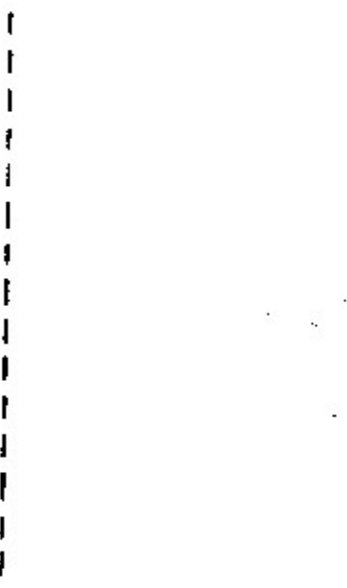
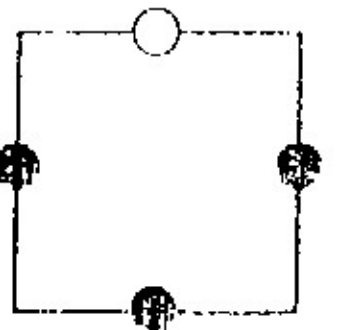
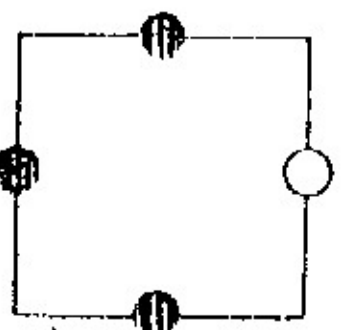
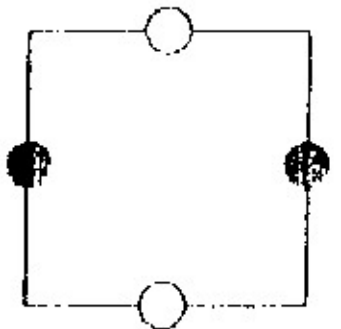
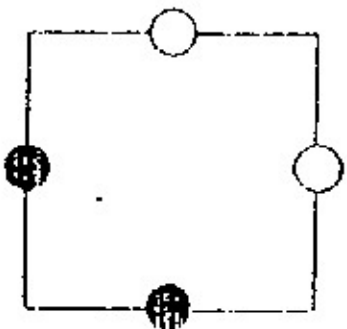
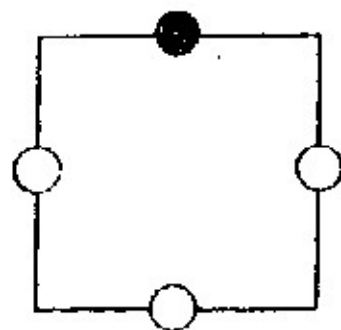
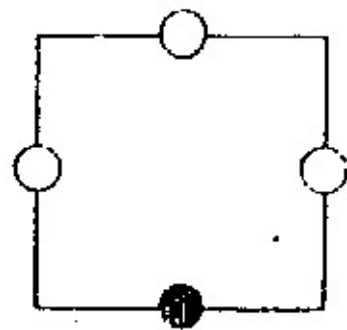

4

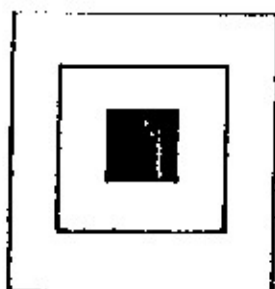
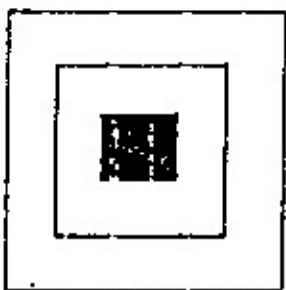
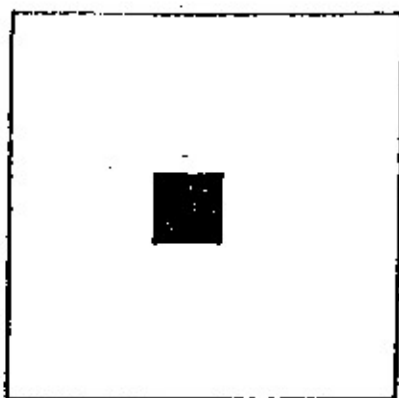
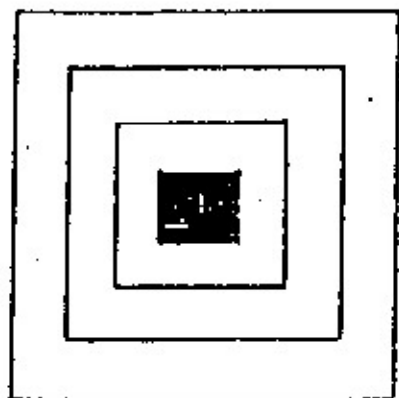

U

U

U

U

U

U

U

U

5

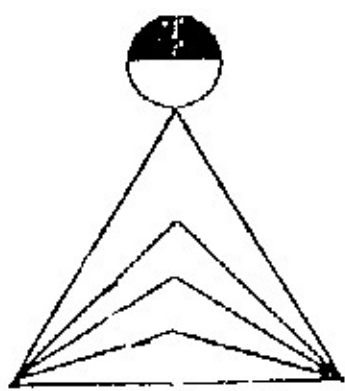
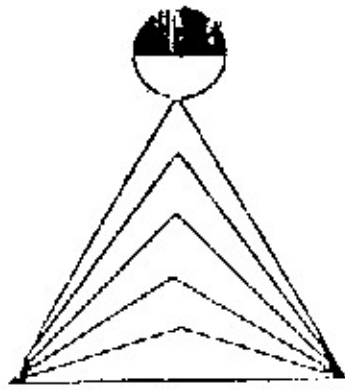
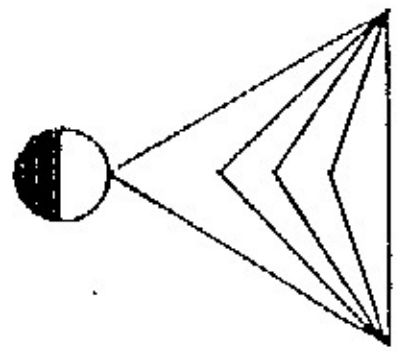
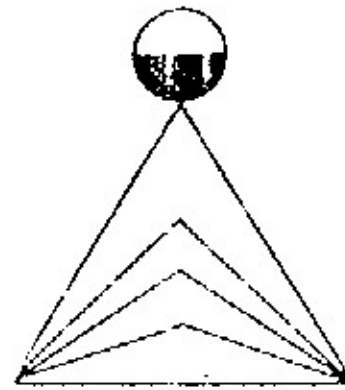
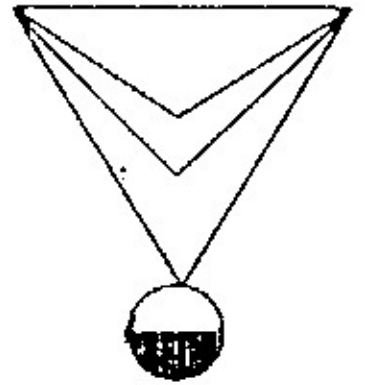
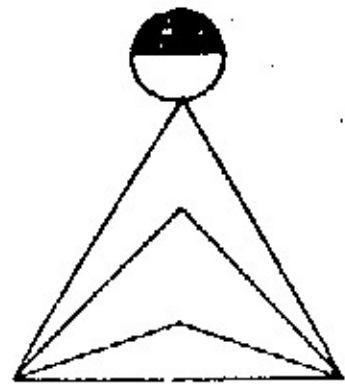
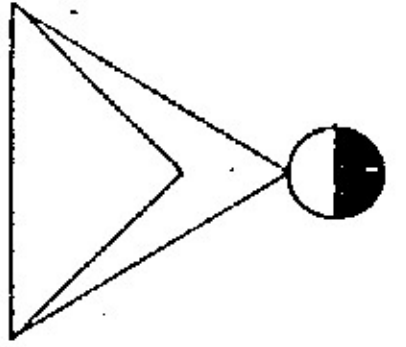

1

6

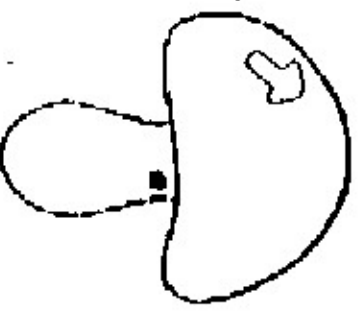
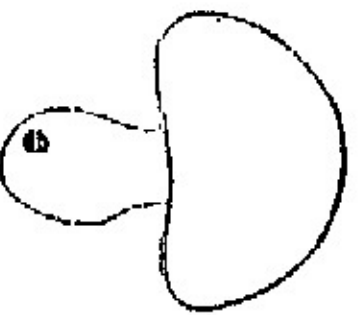
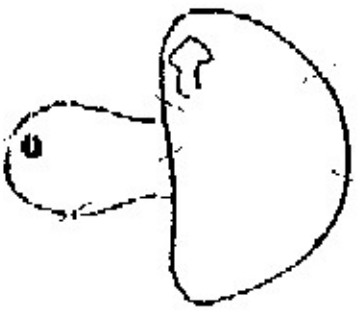
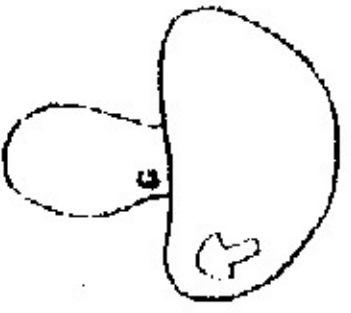
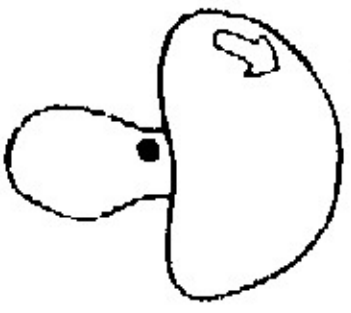

2

3

4

5

7

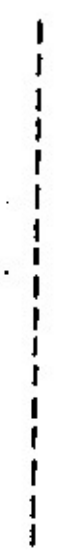
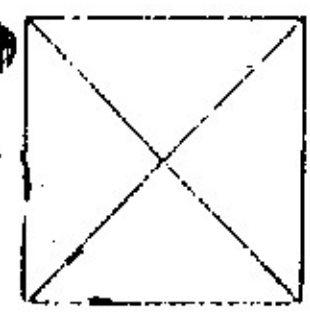
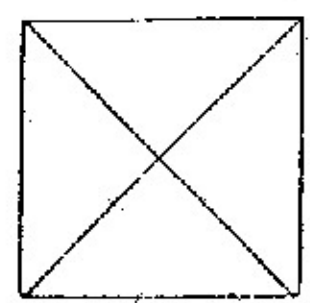
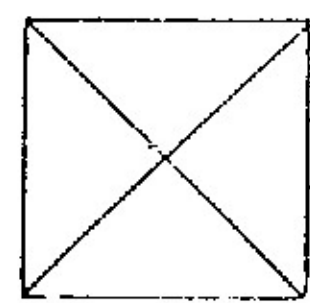
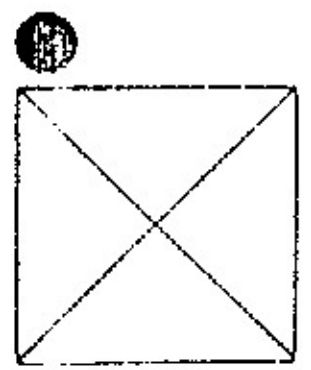
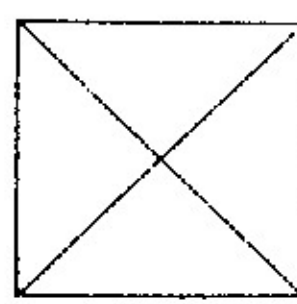
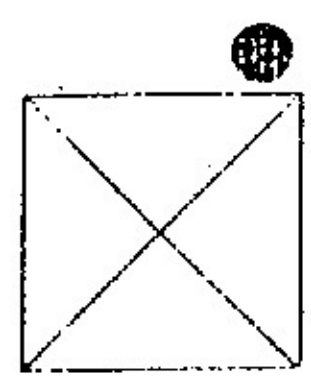
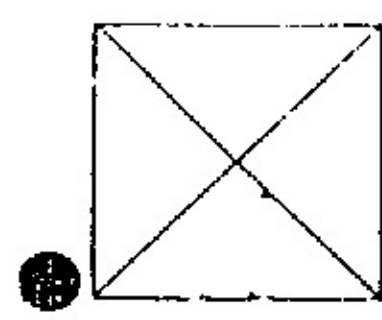

6

8

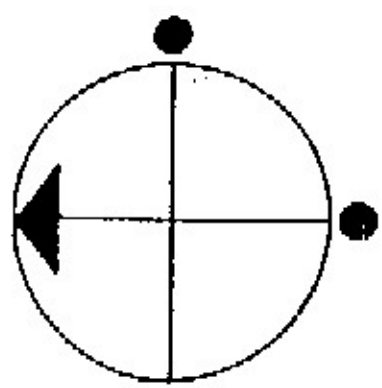
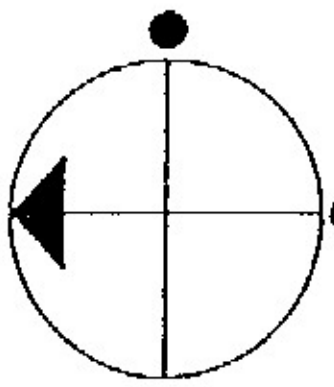
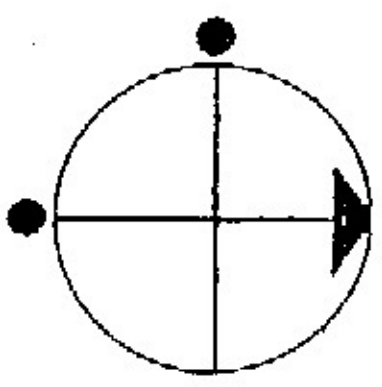
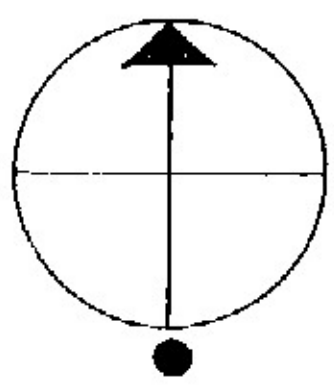
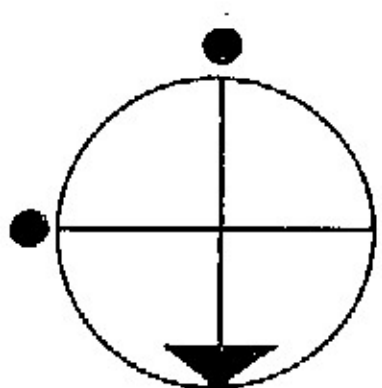
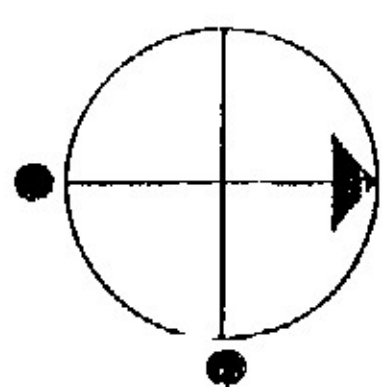

5

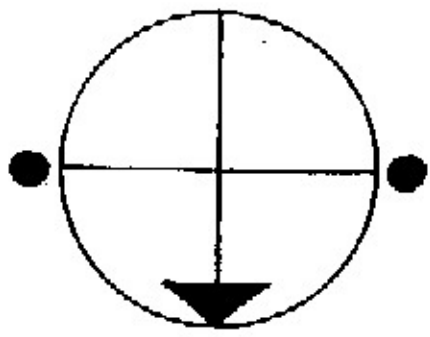

4

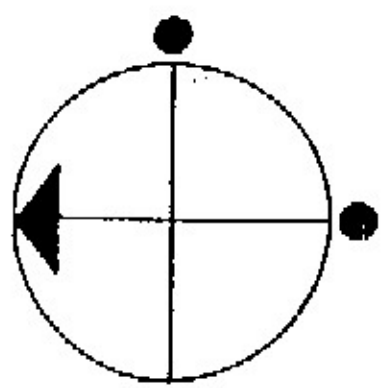

3

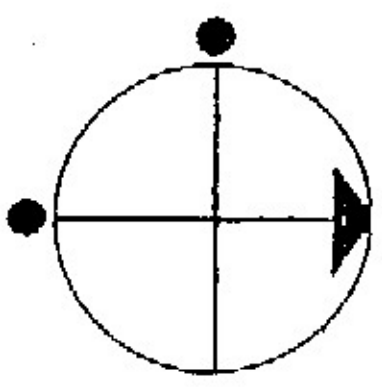

2

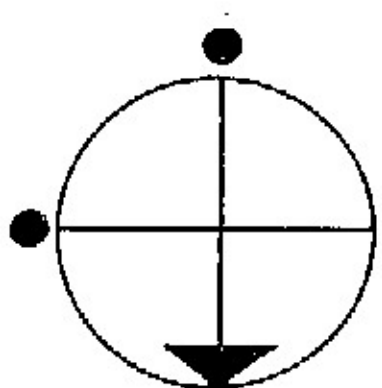

1

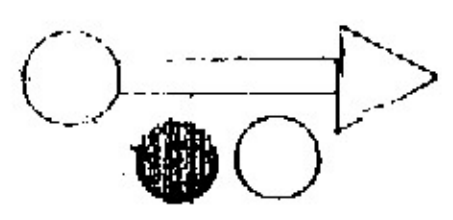
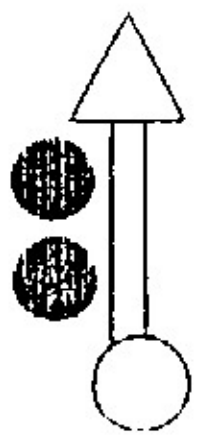
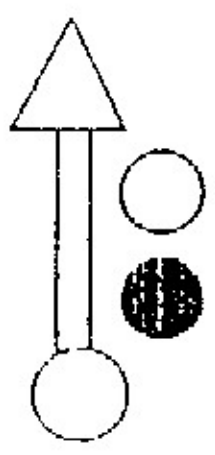
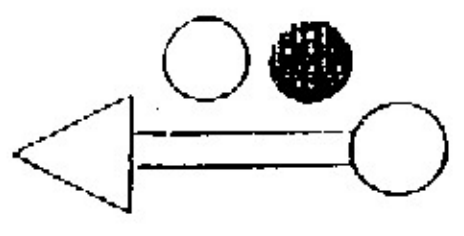
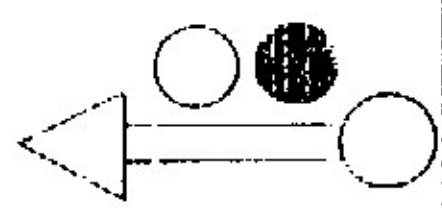
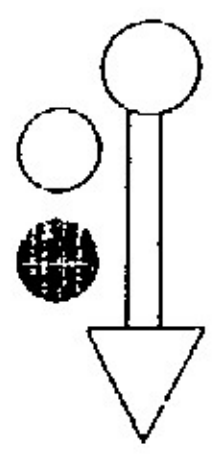
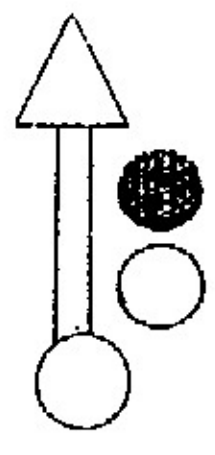
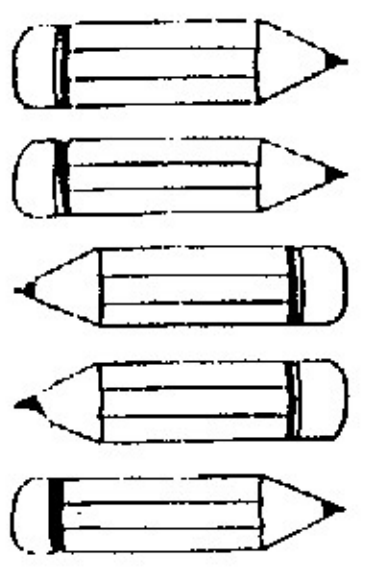
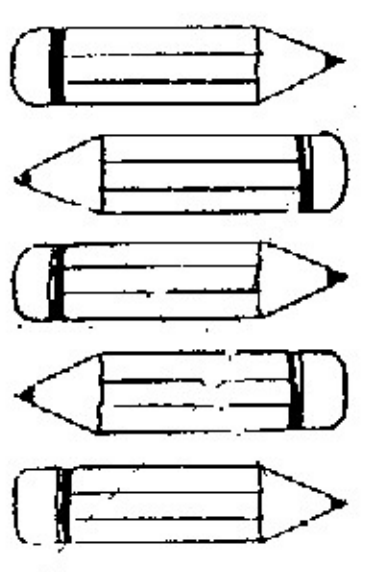
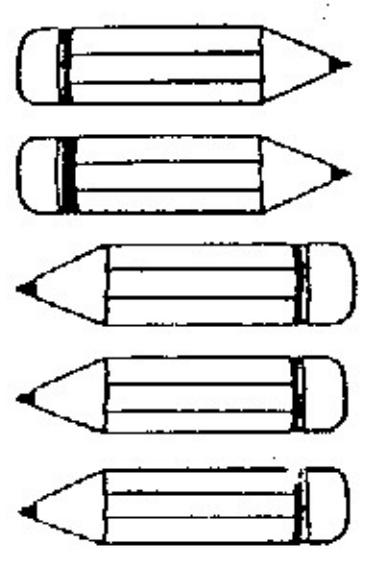
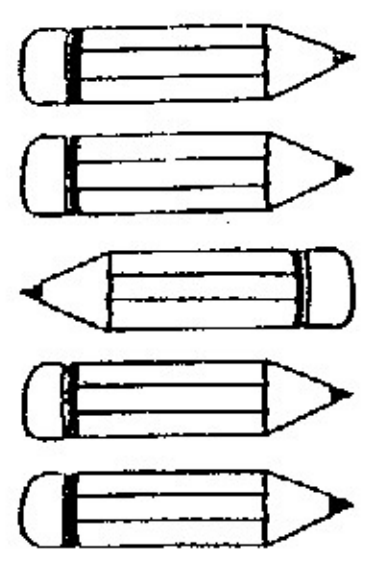
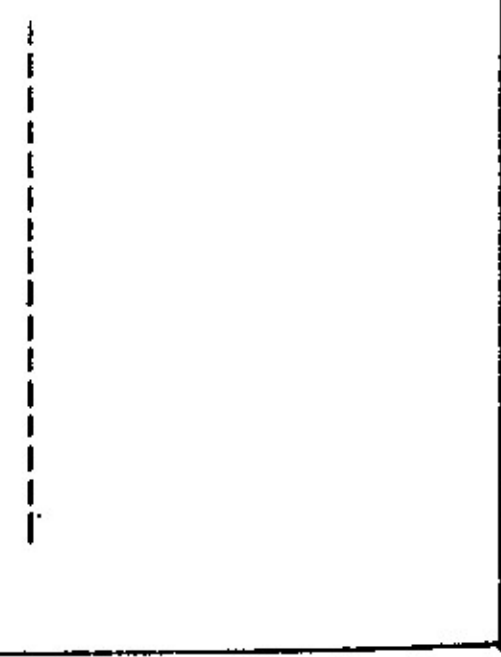
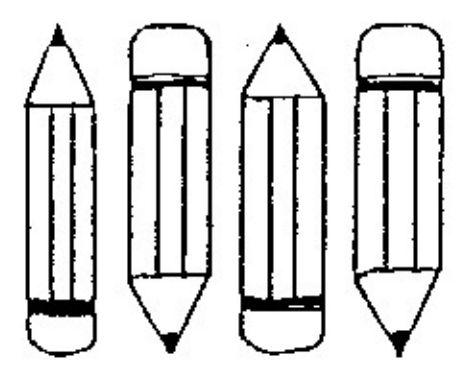
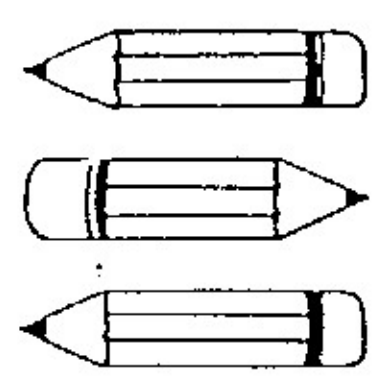
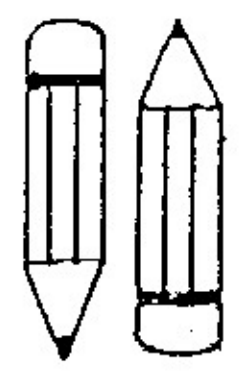

u

u

u

u

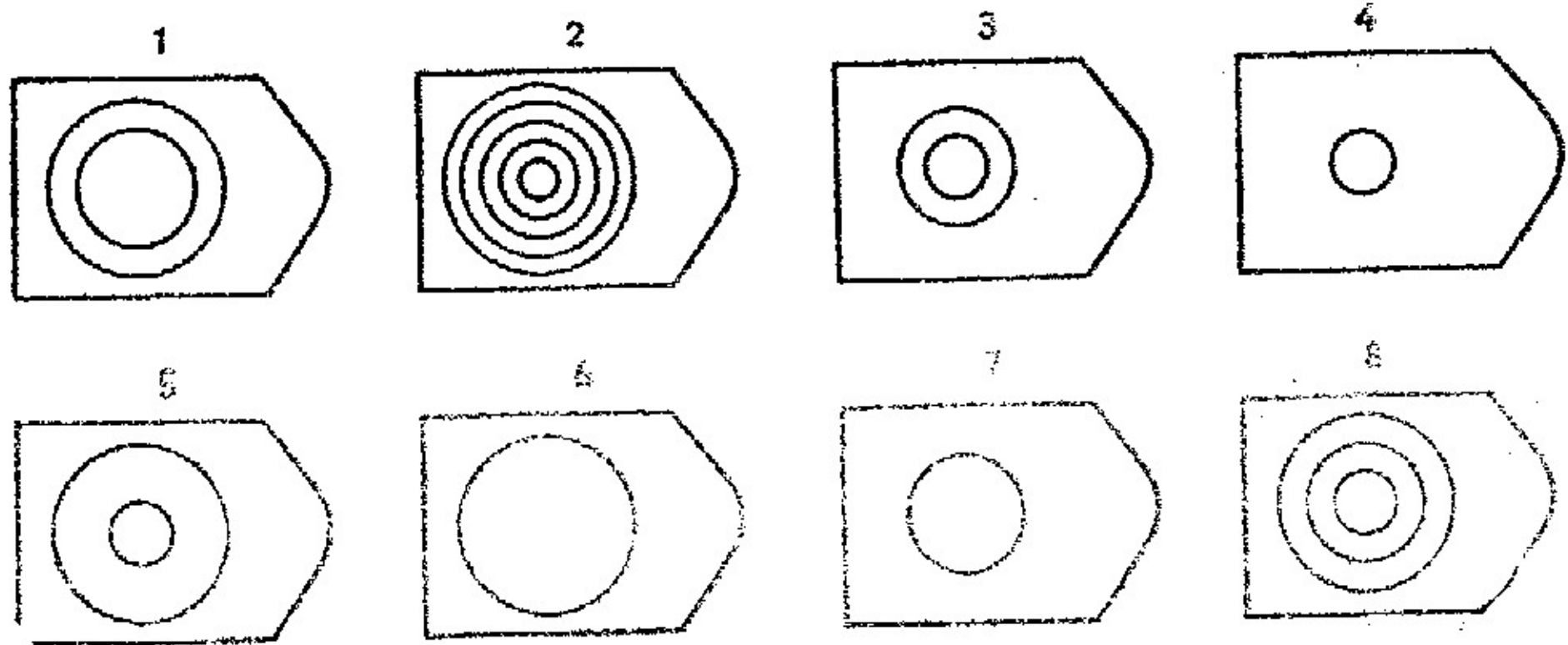
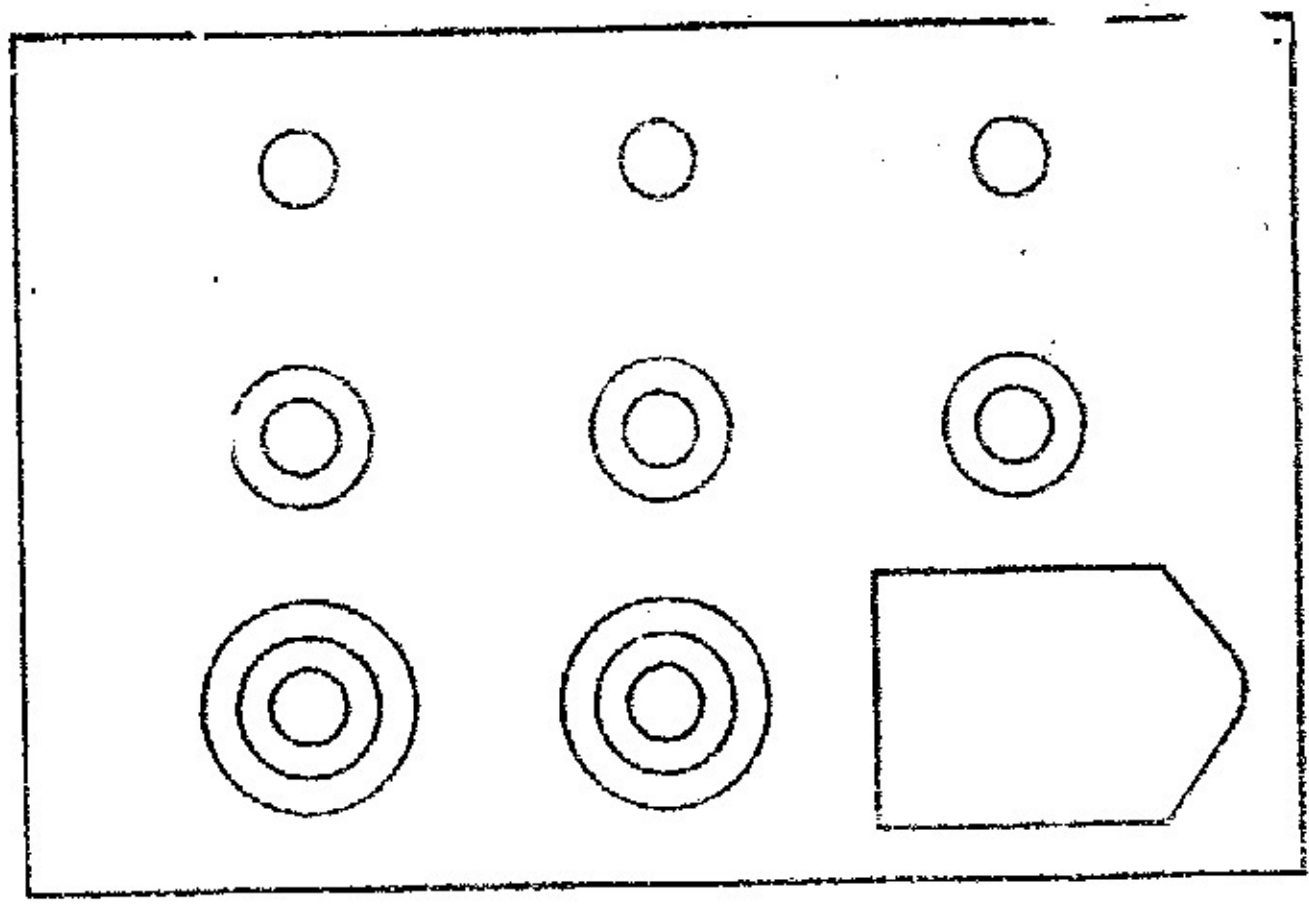

C2

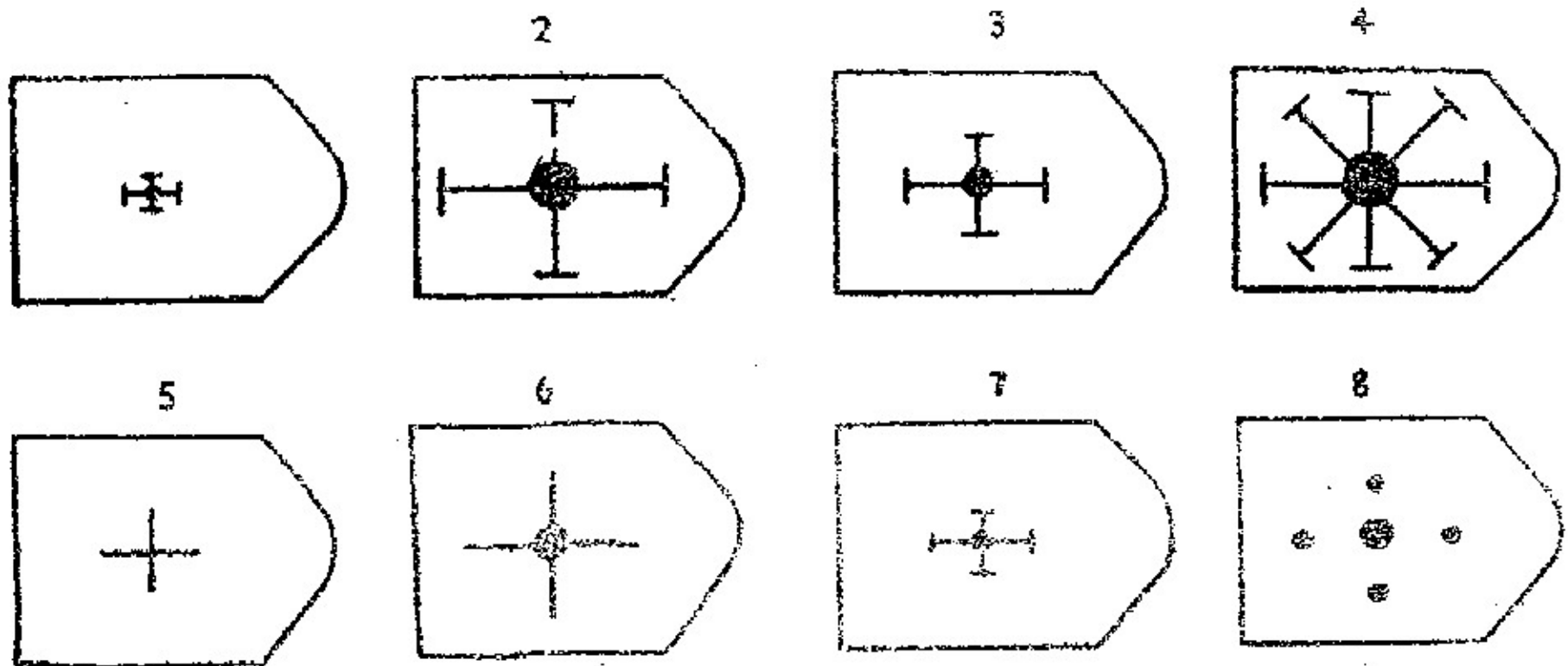
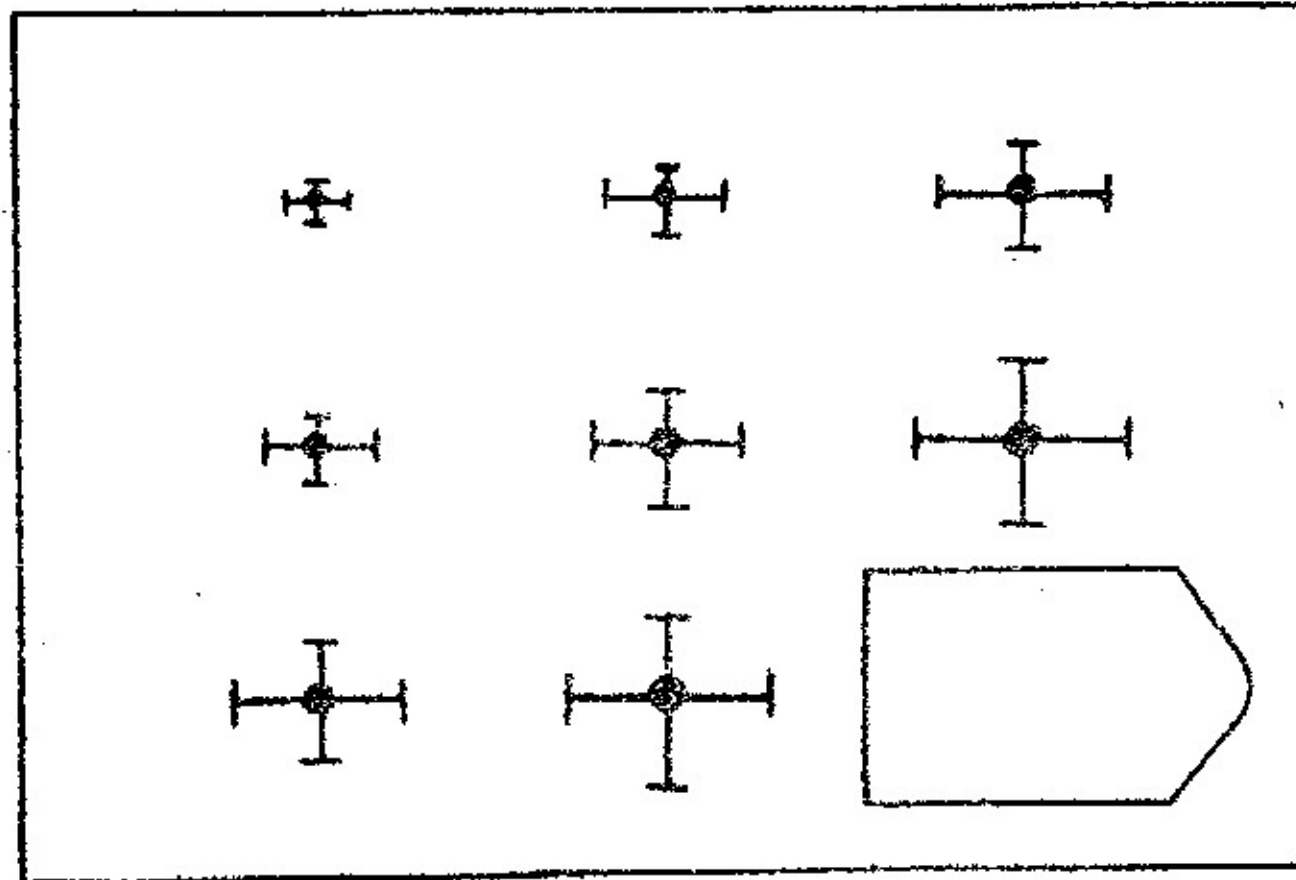

C3

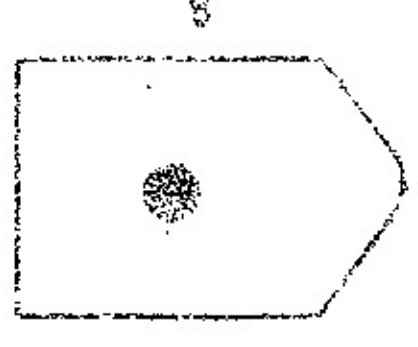
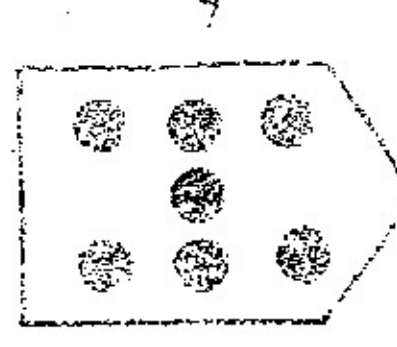
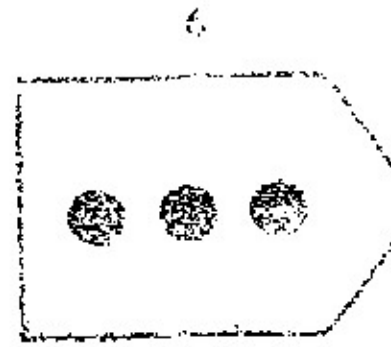
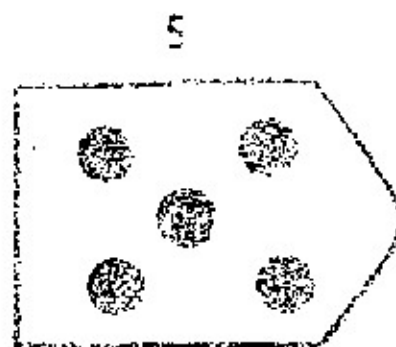
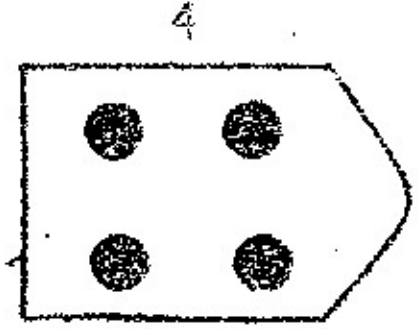
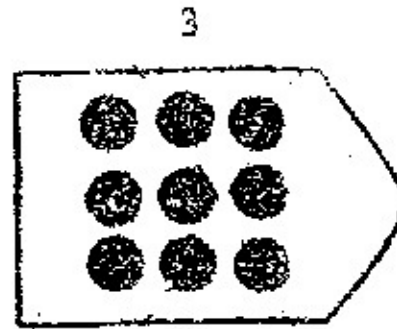
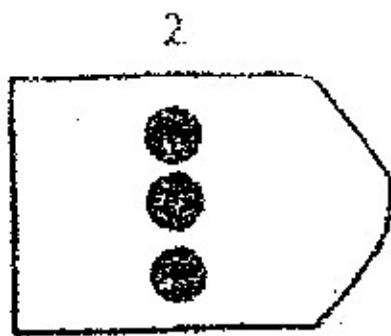
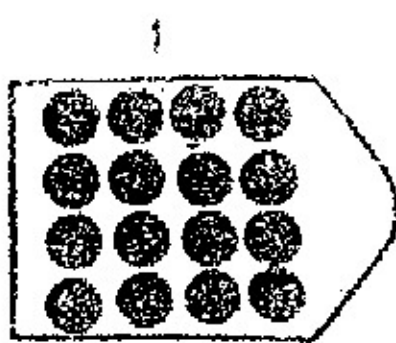
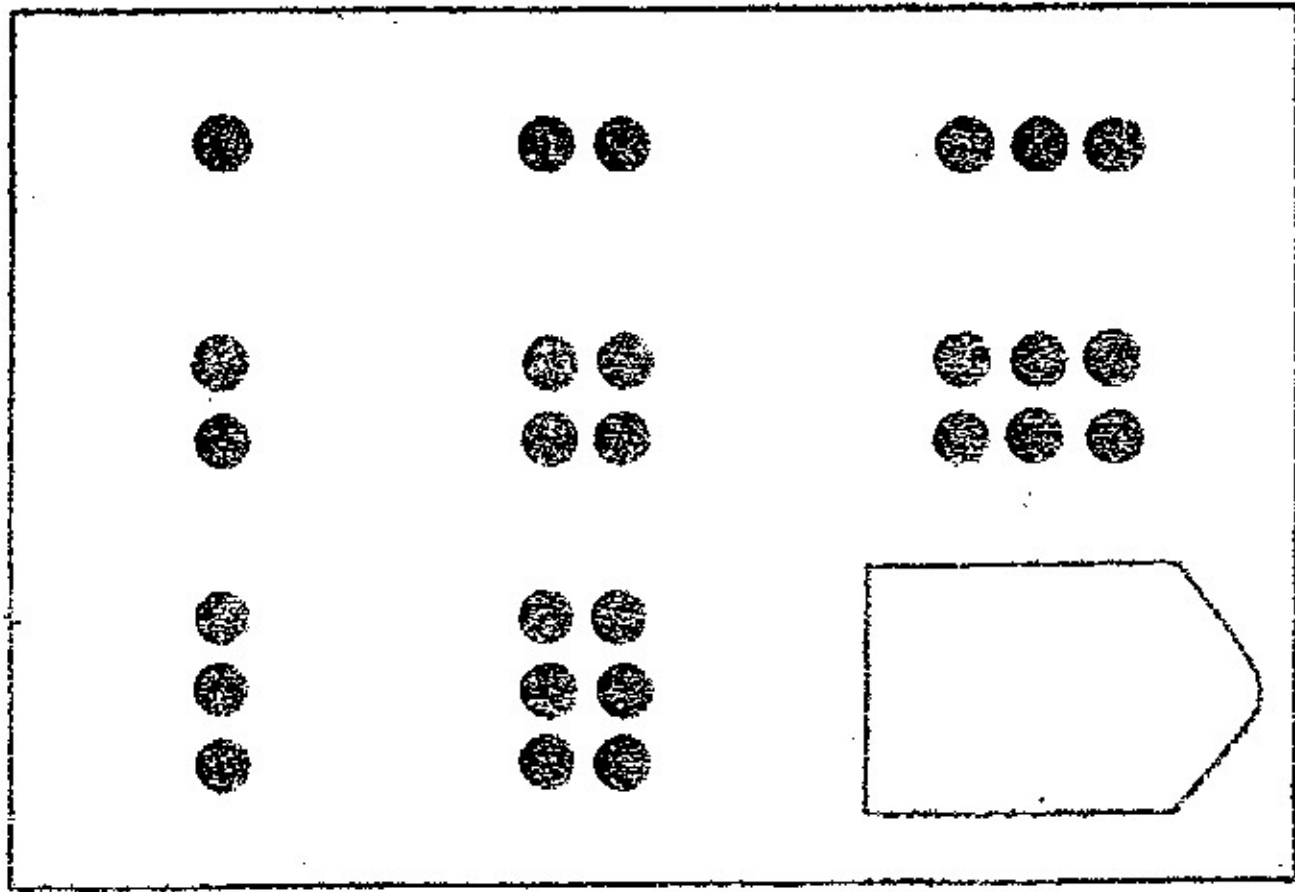

C4

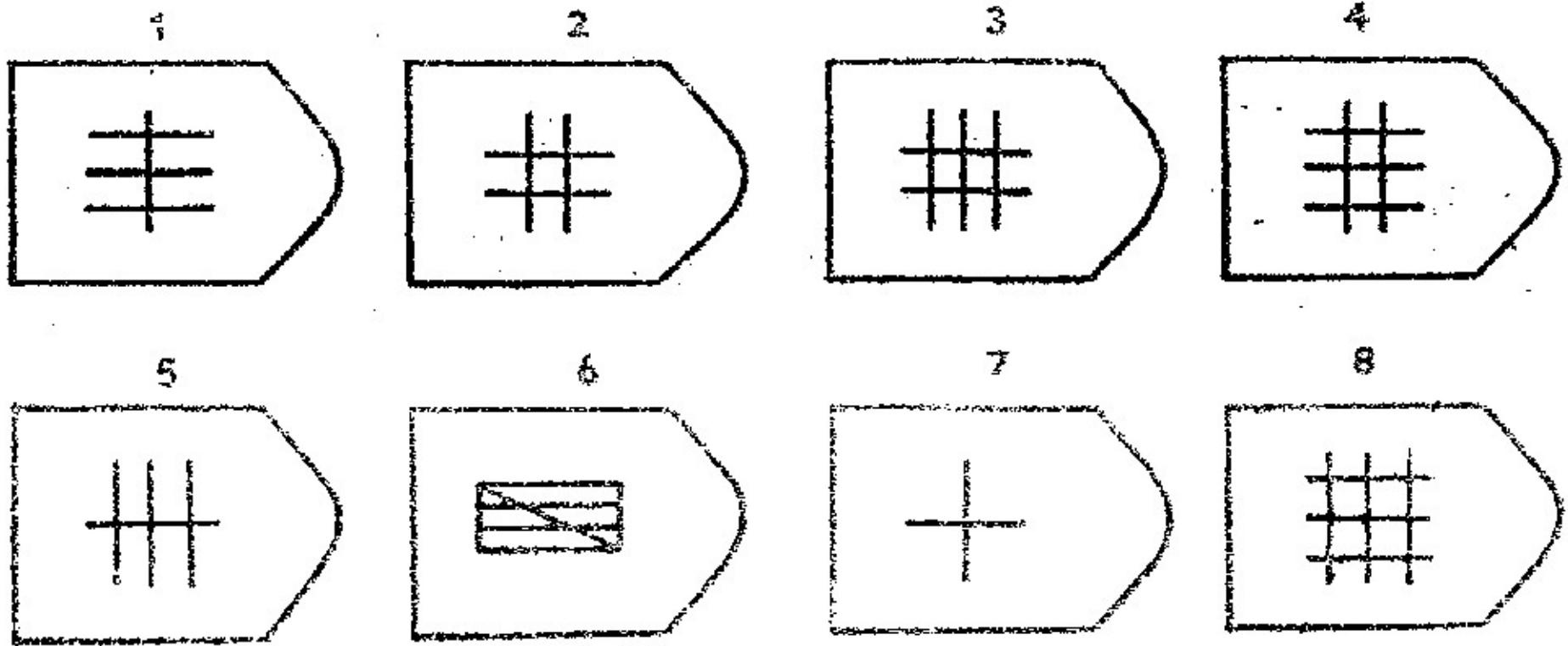
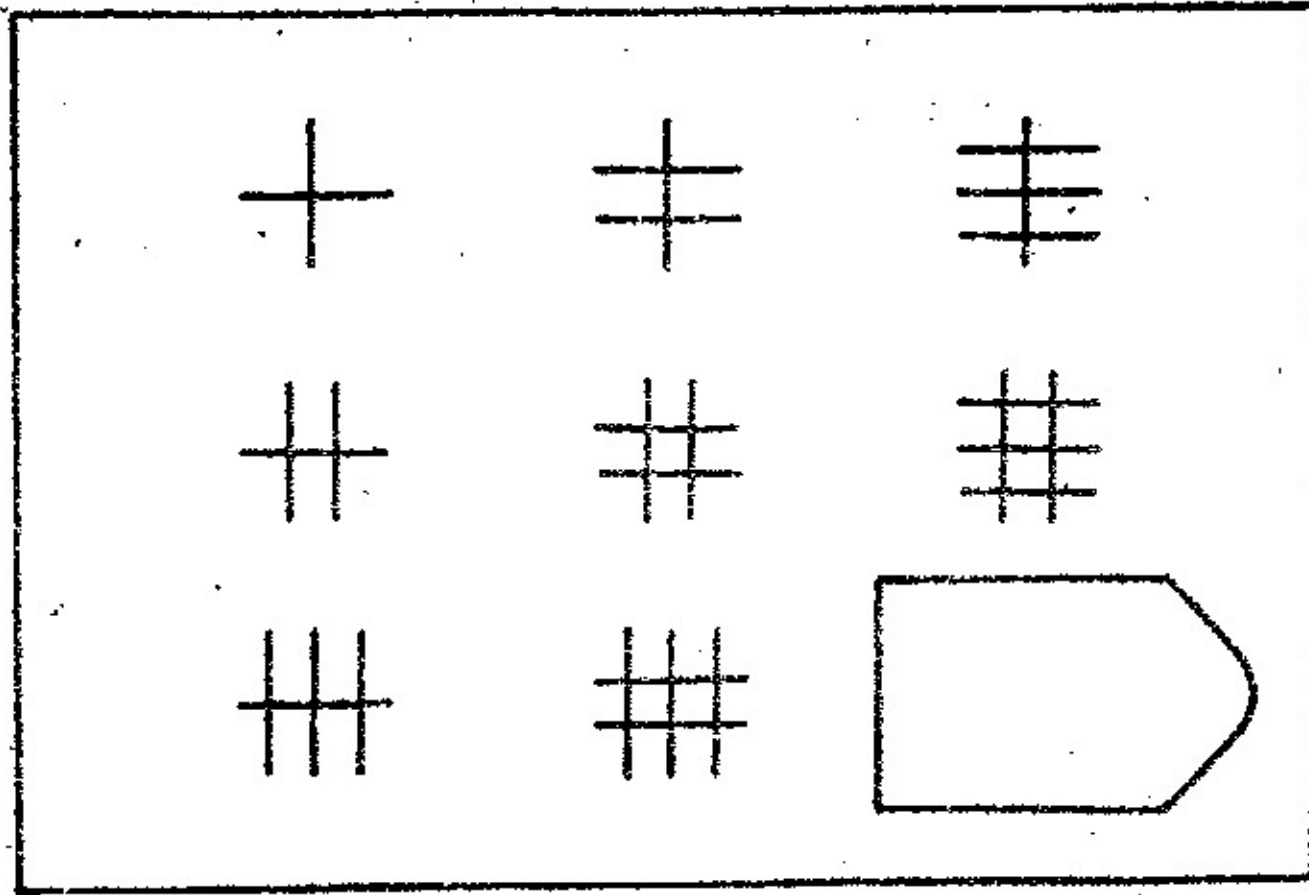

C 5

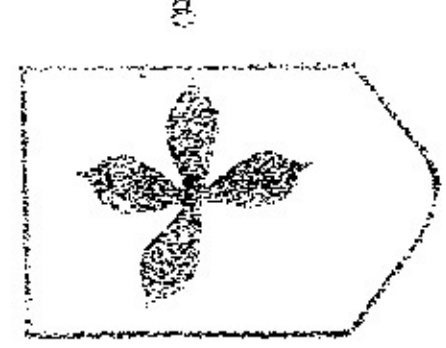
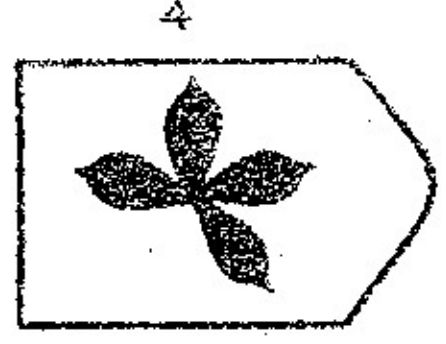
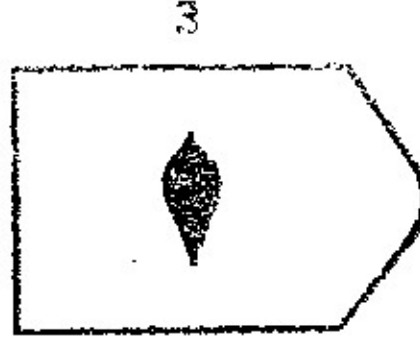
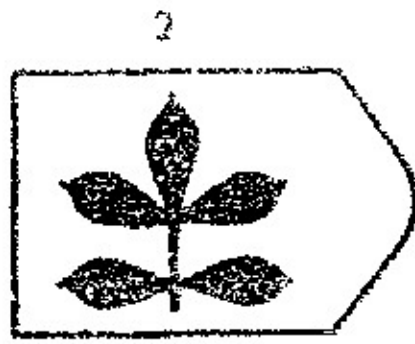
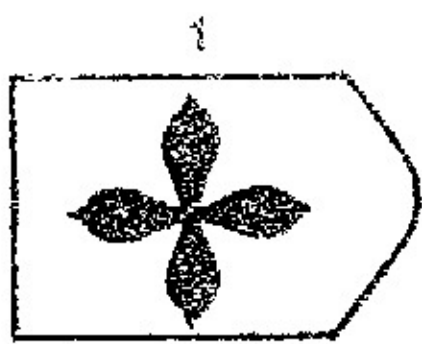
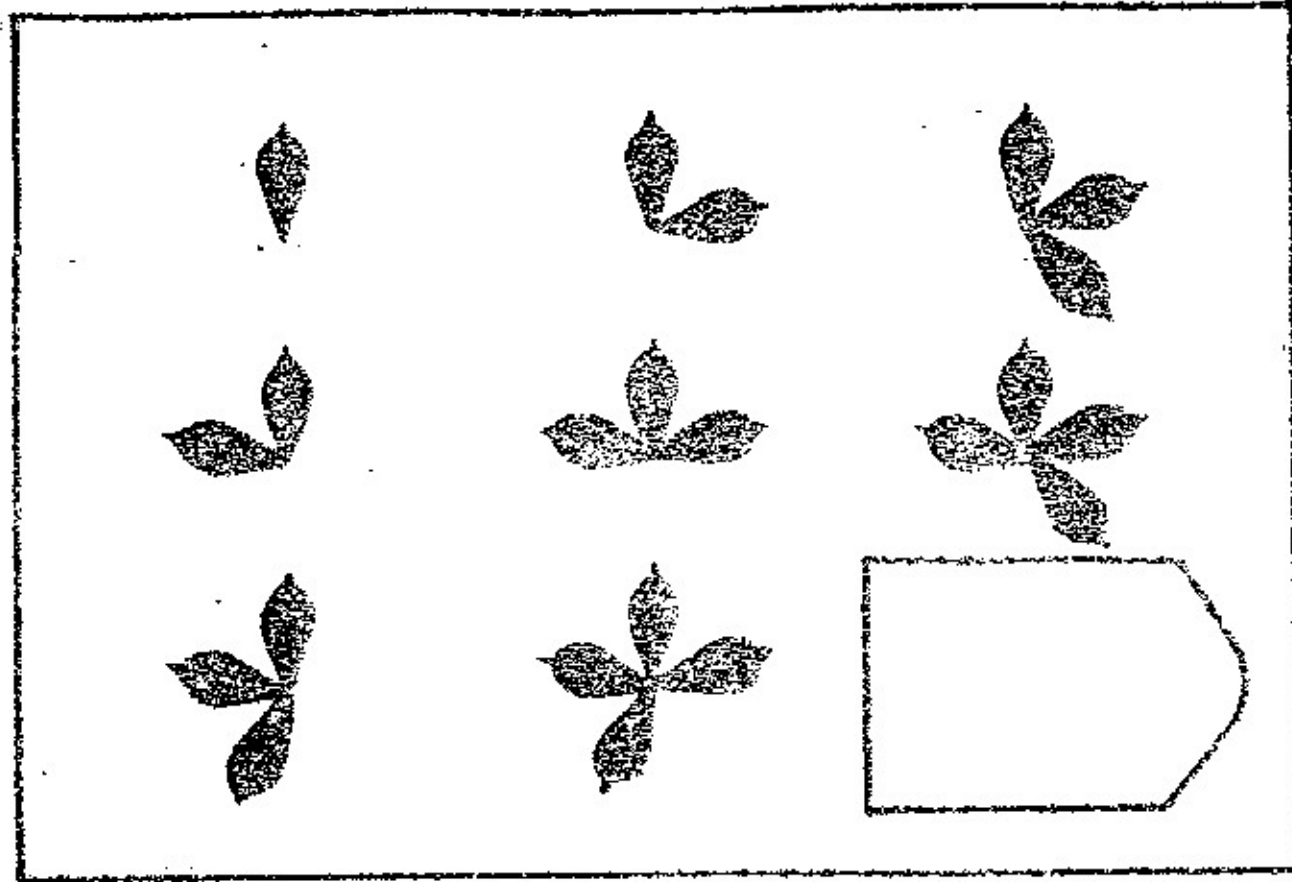

C6

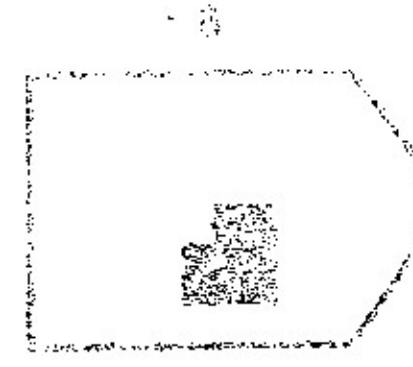
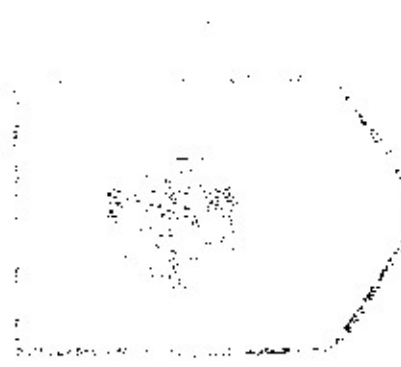
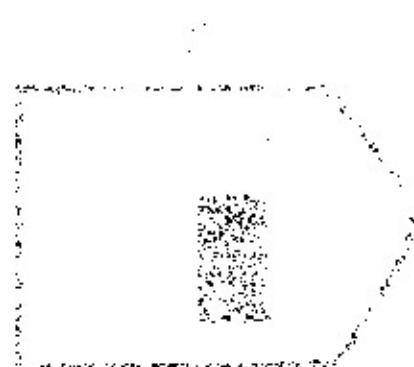
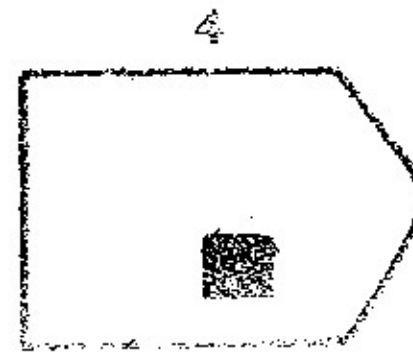
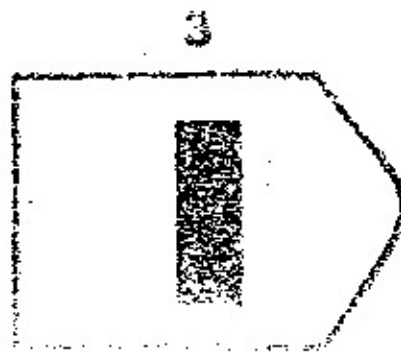
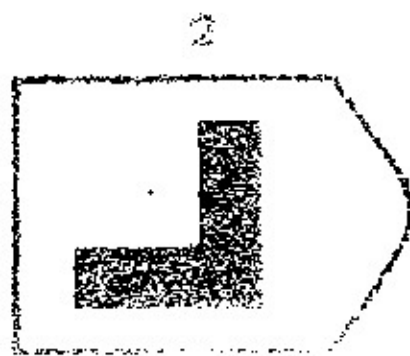
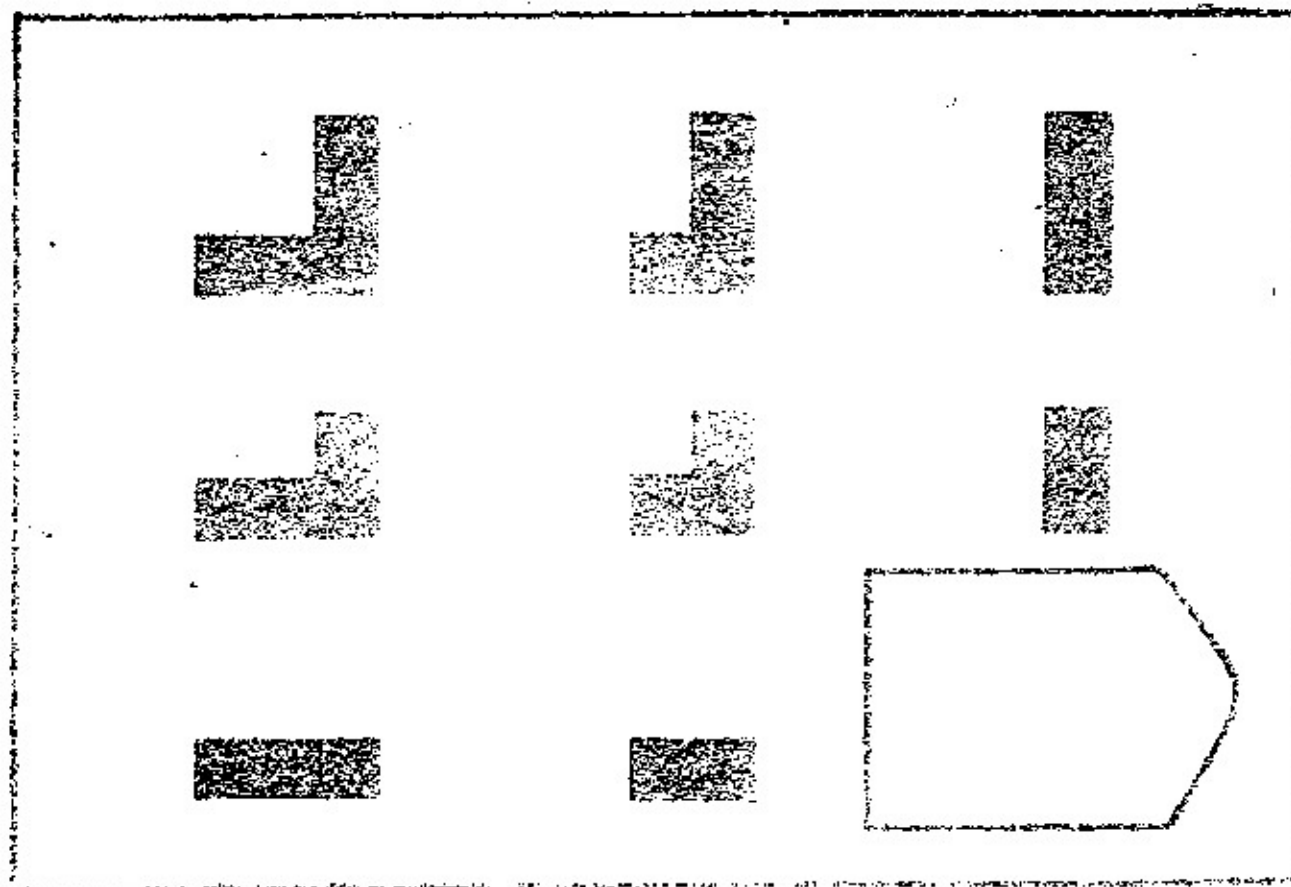

C7

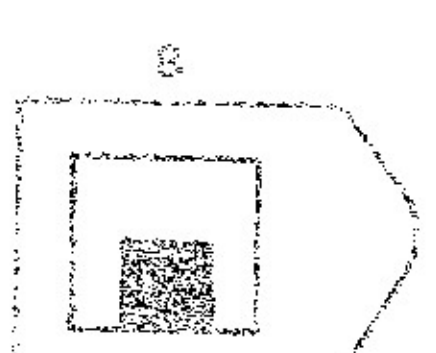
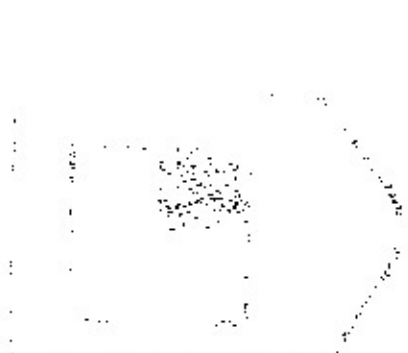
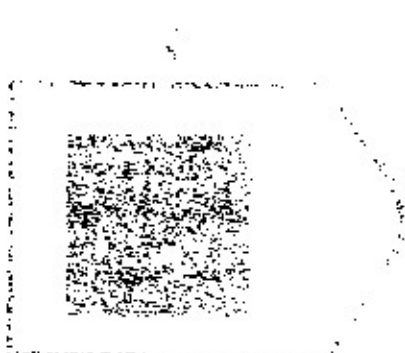
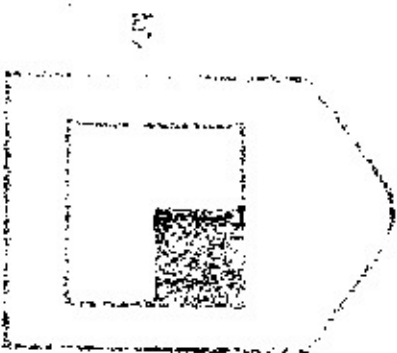
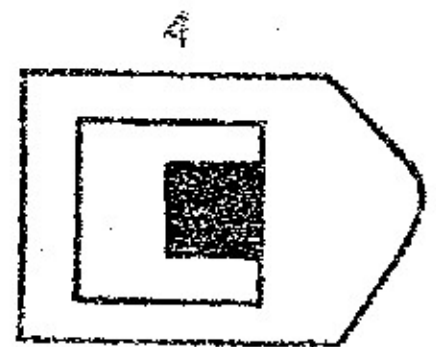
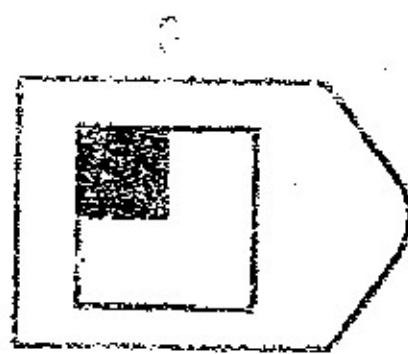
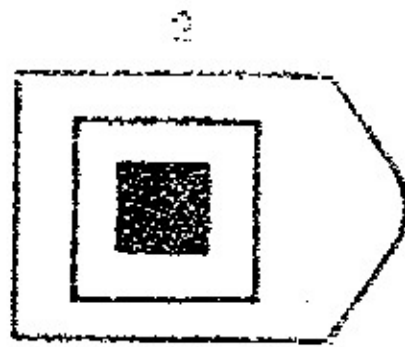
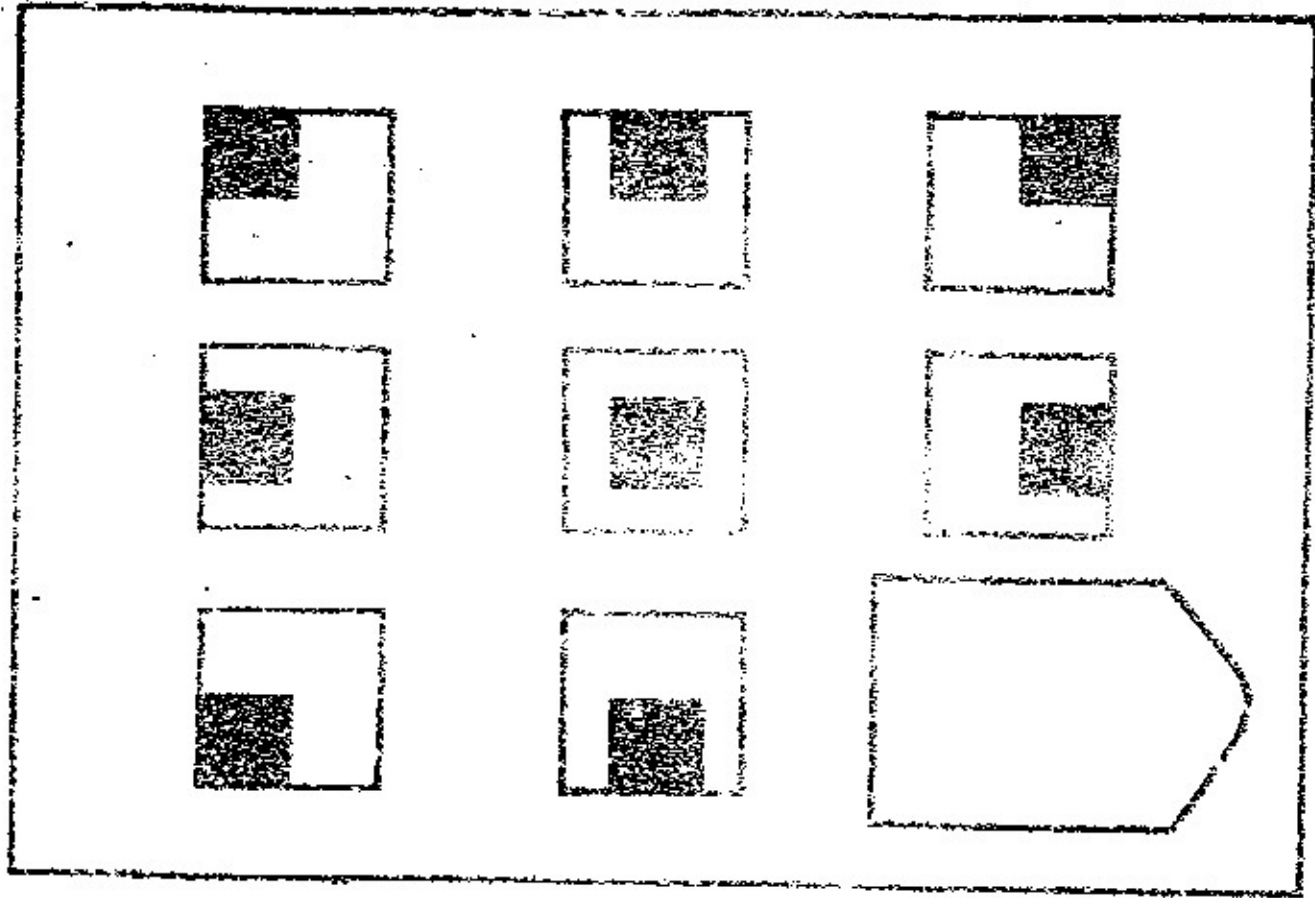

C8

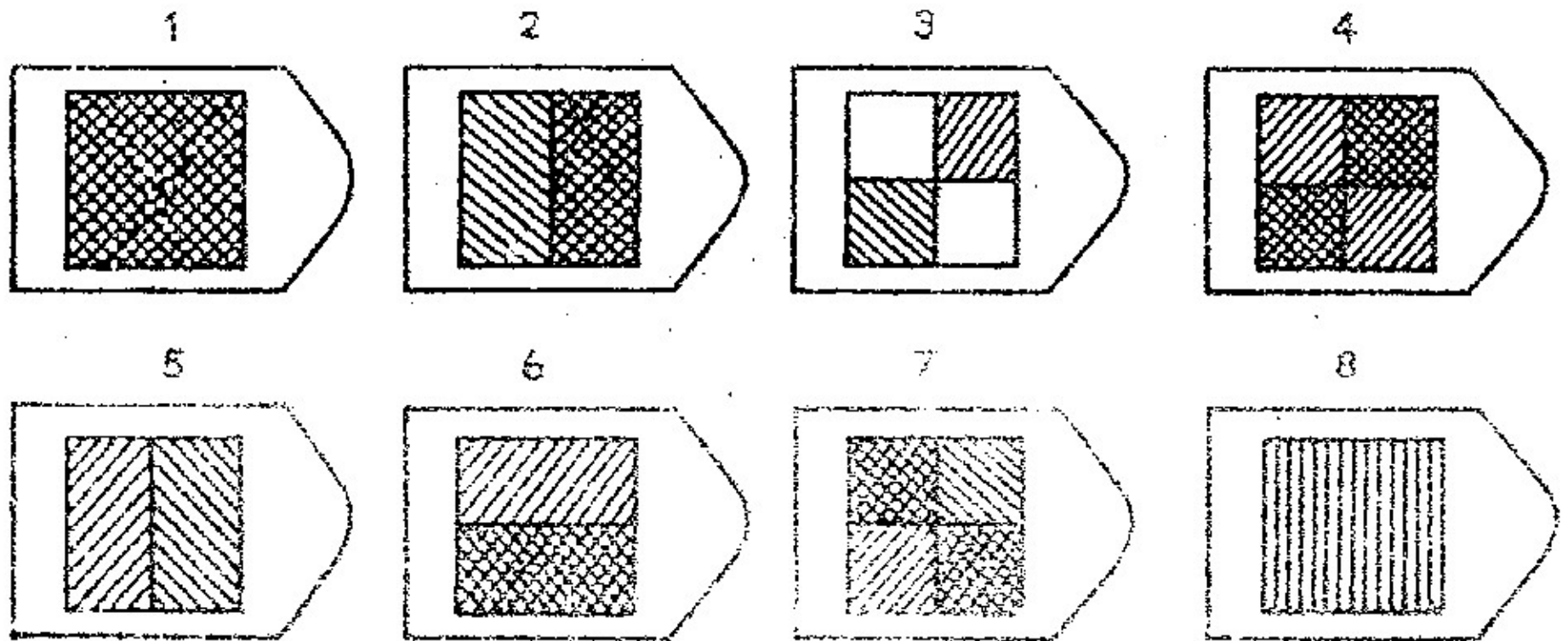
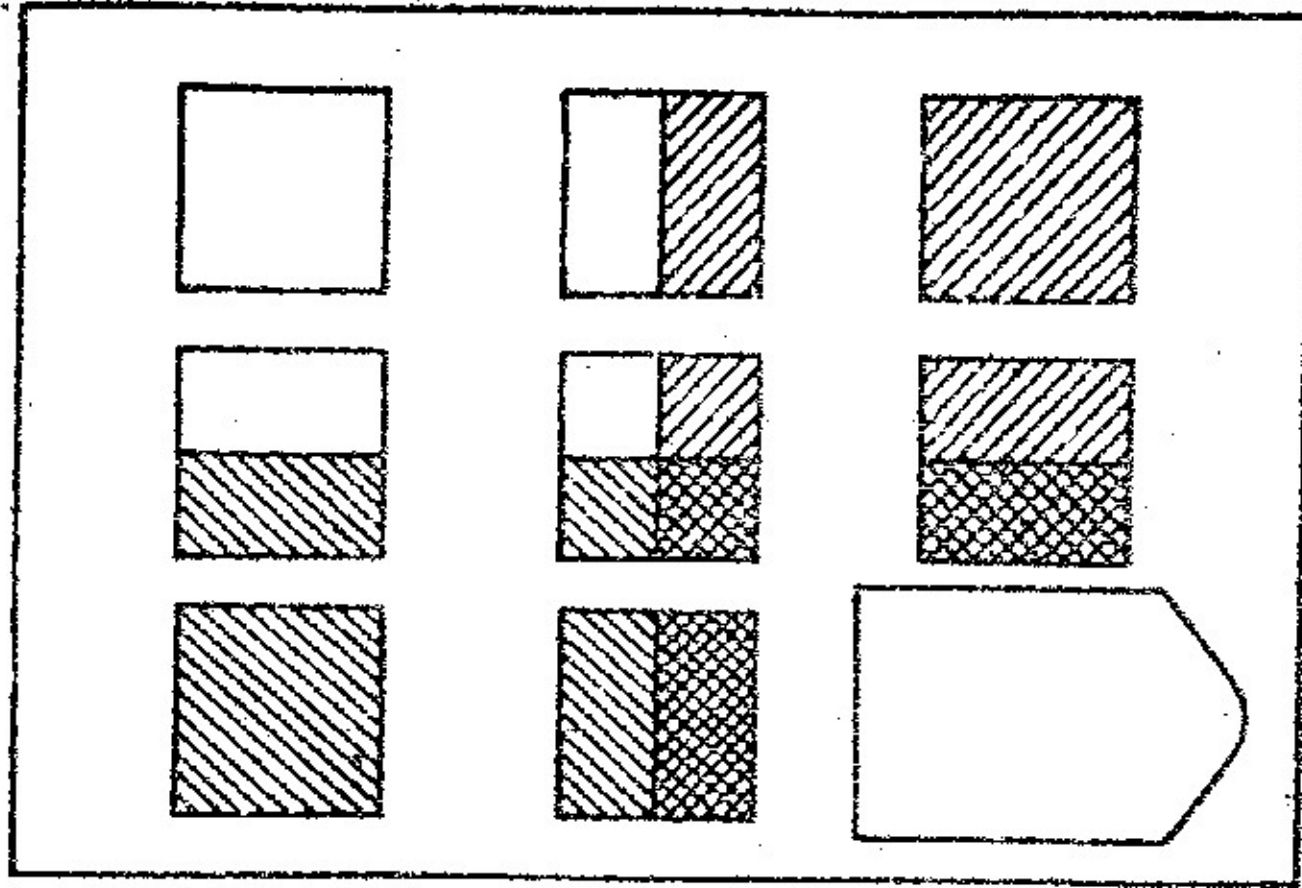

Cs

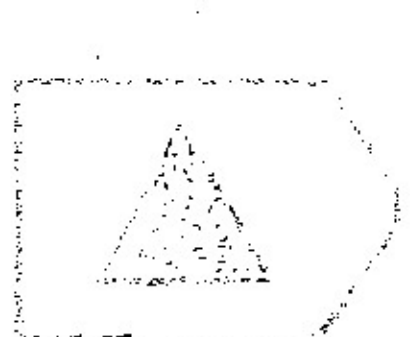
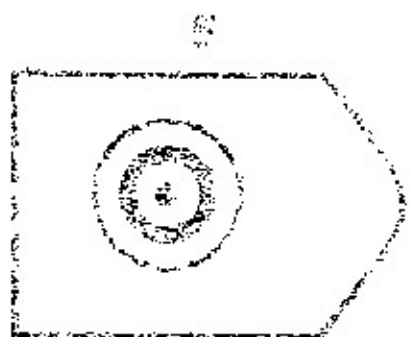
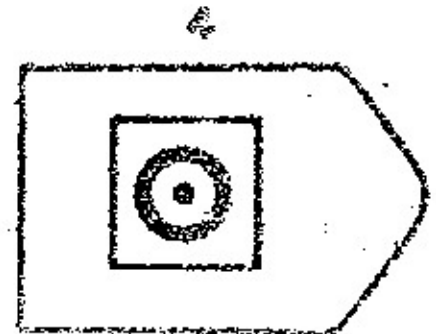
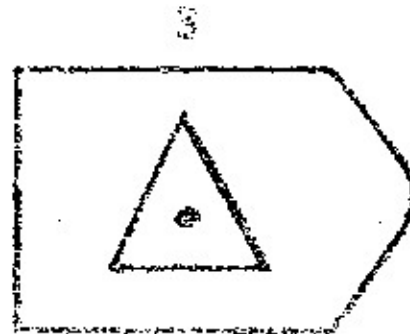
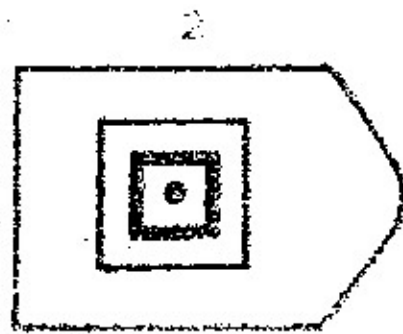
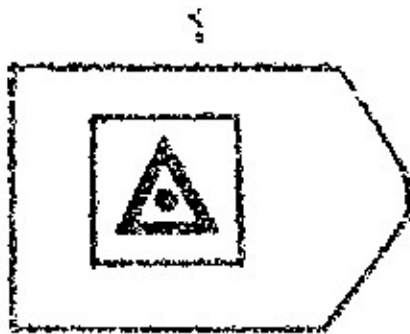
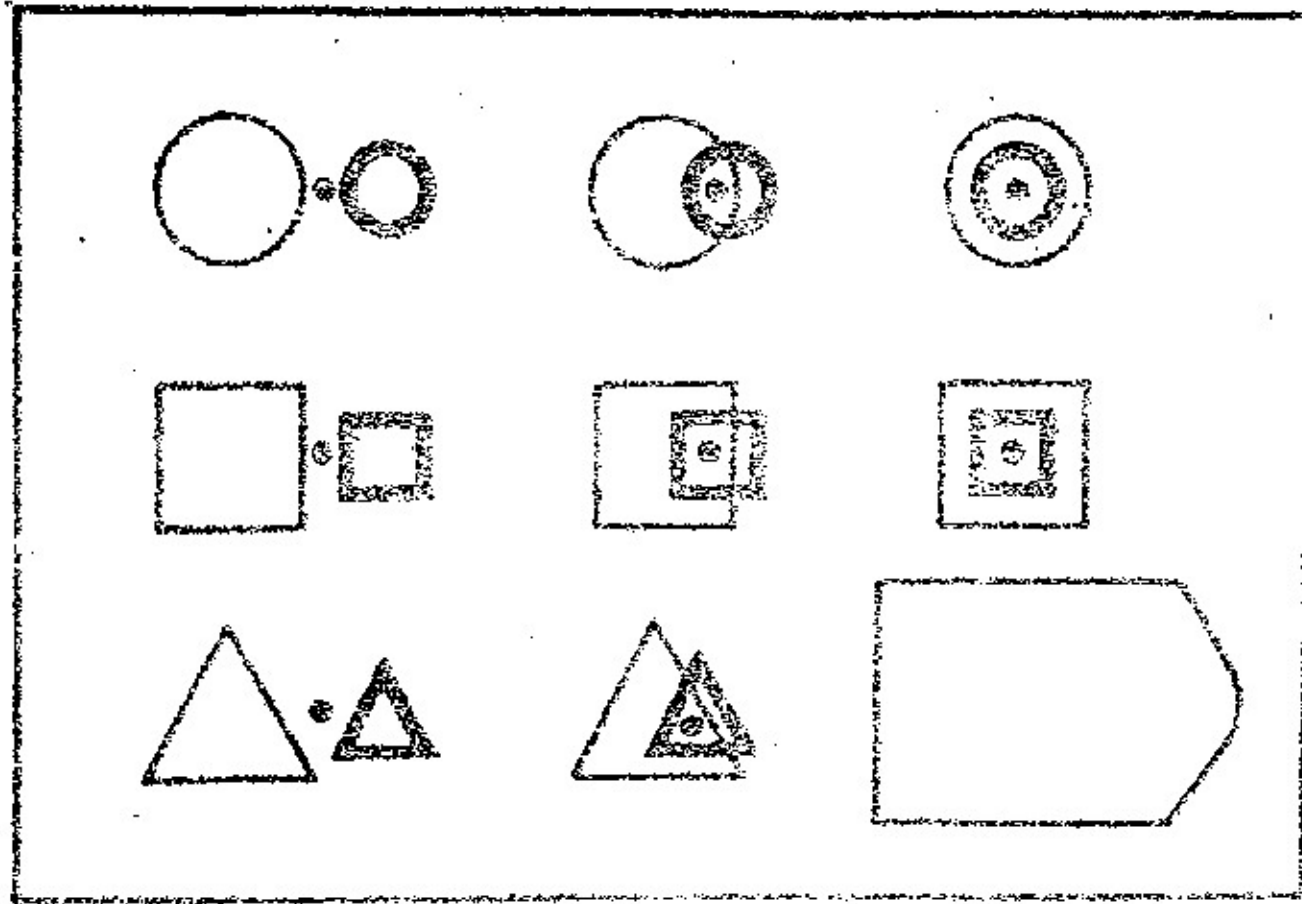

C 10

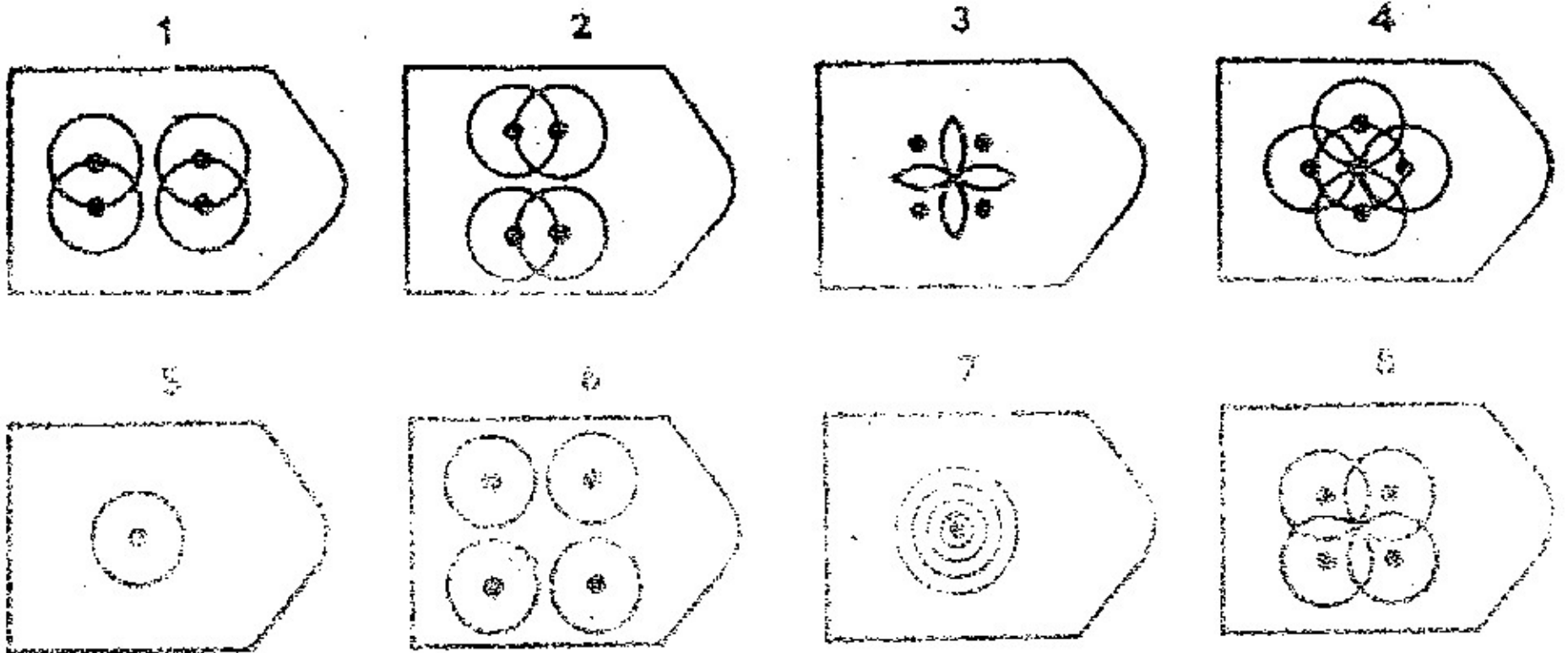
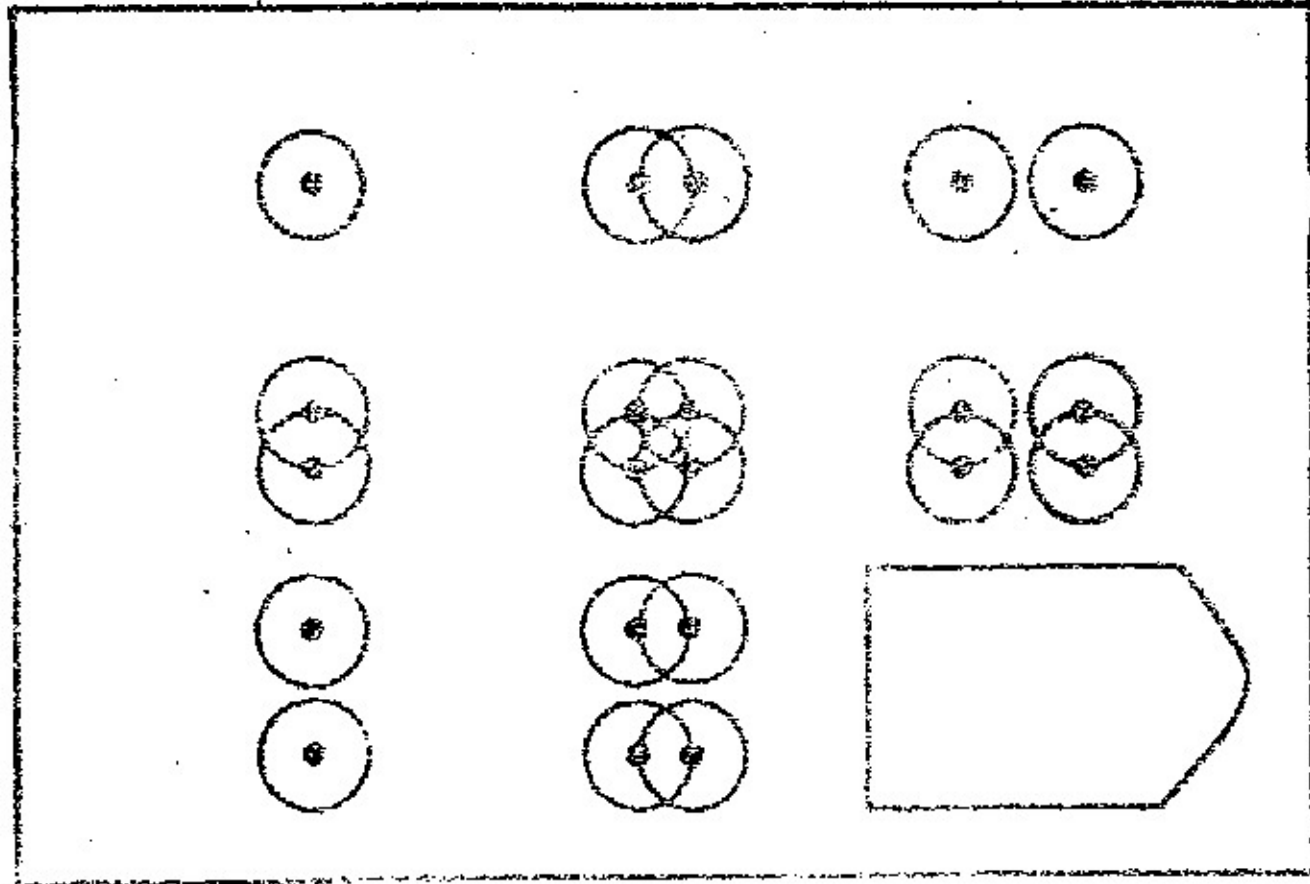



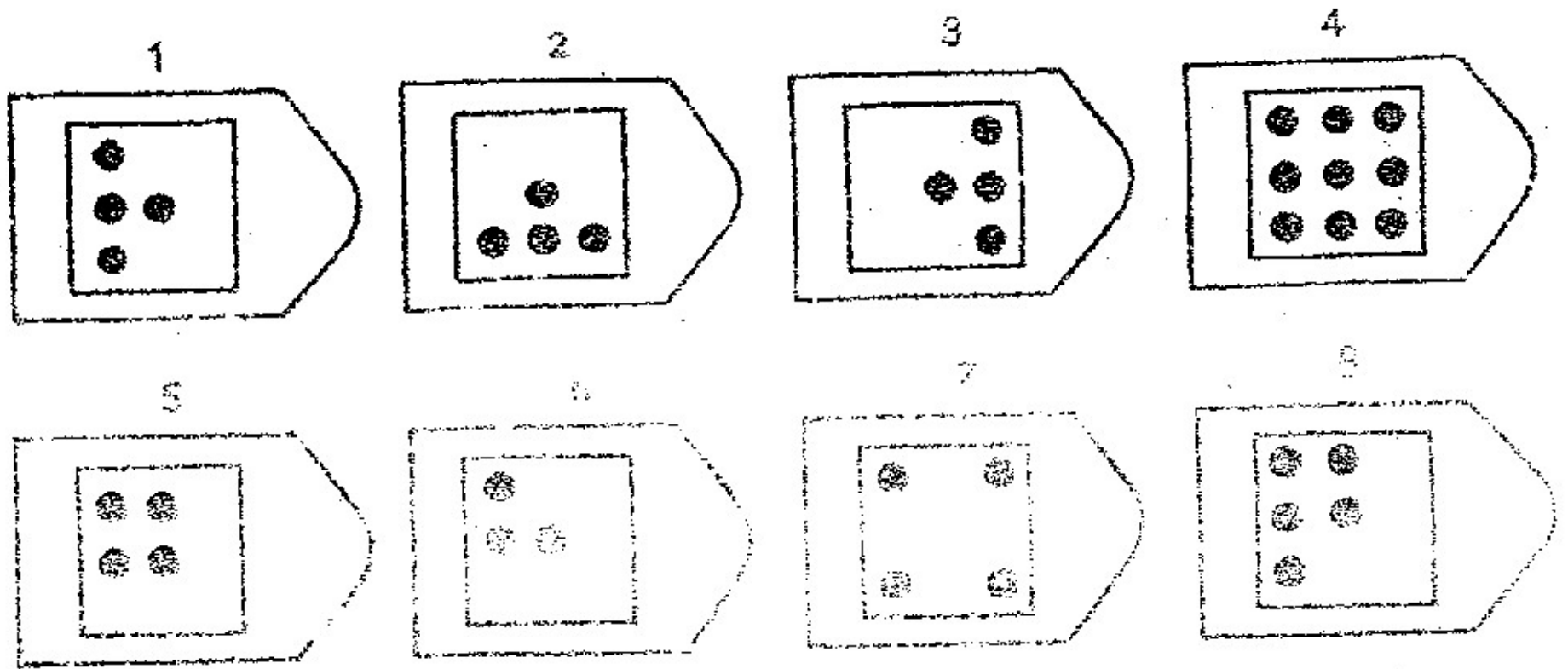
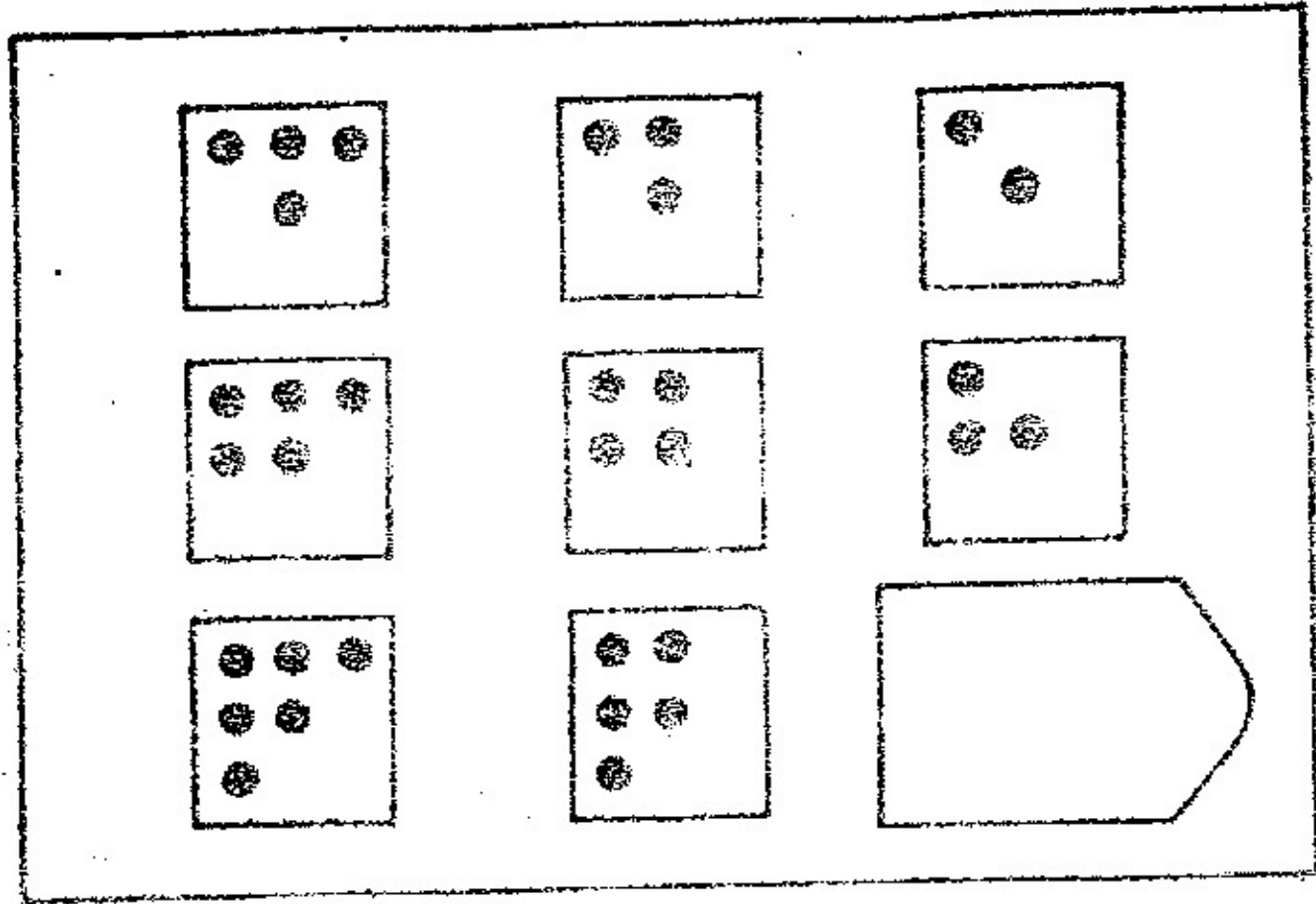



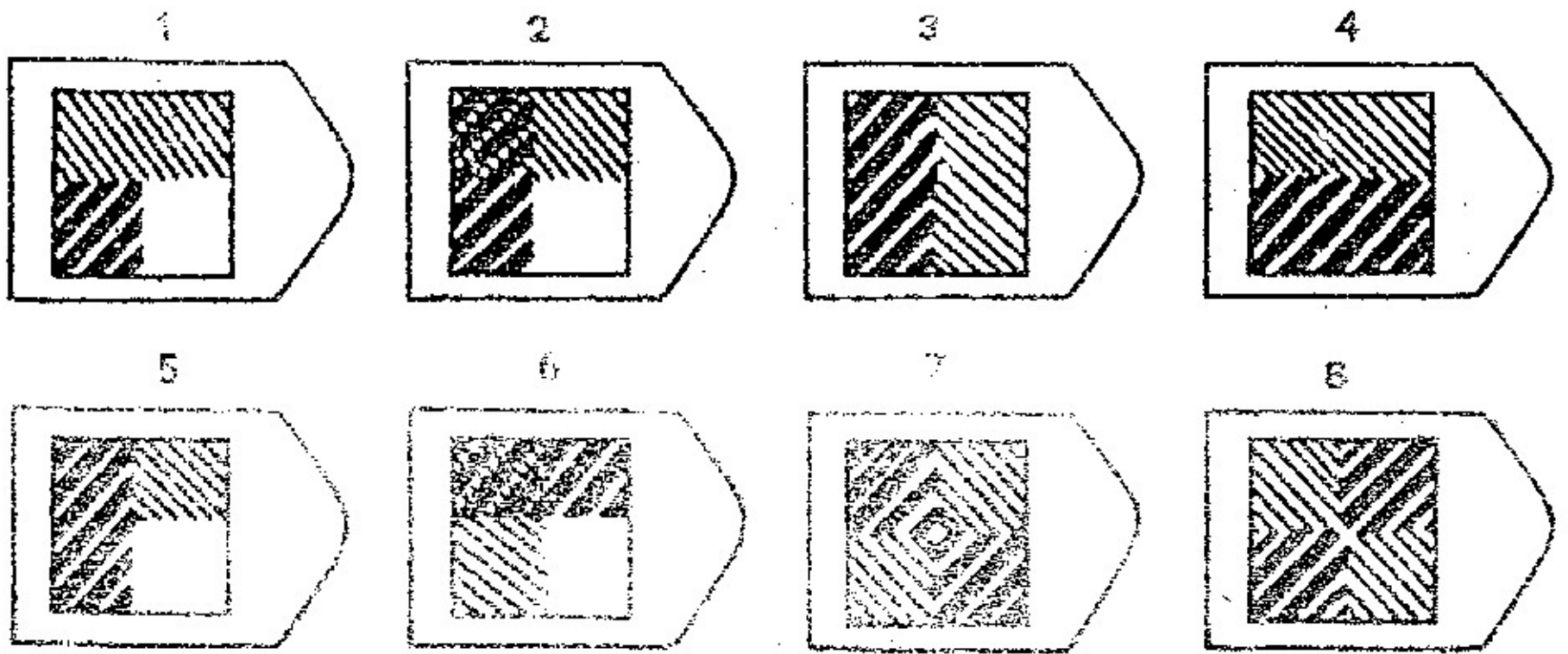
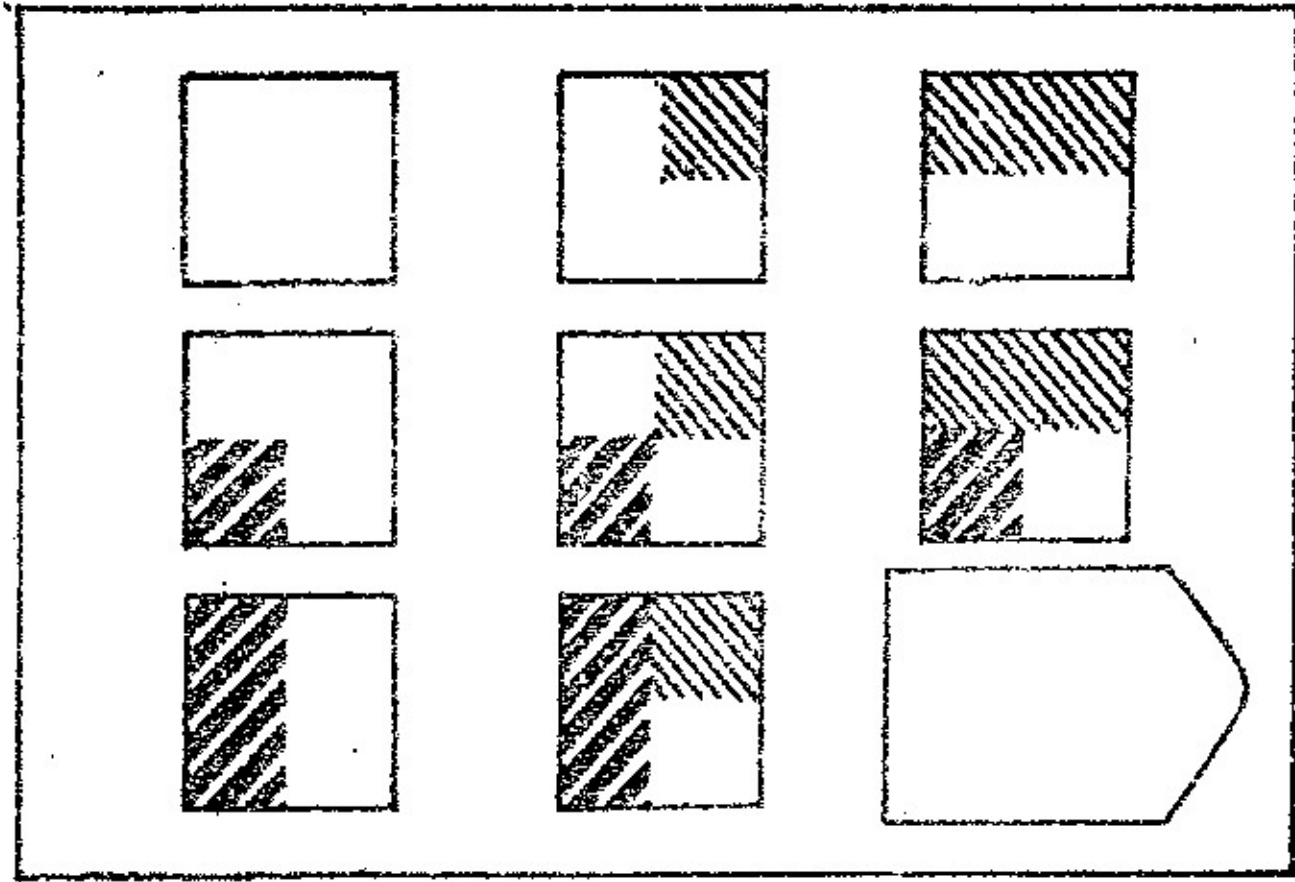



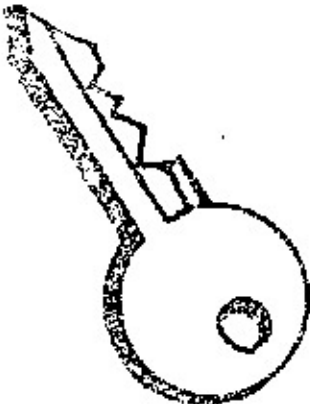
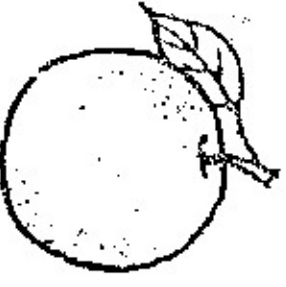

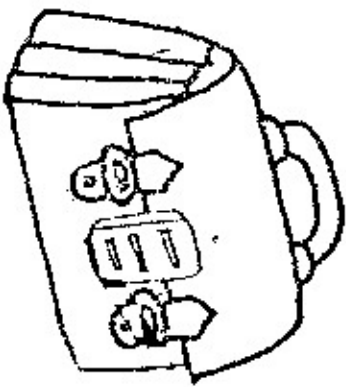

C11

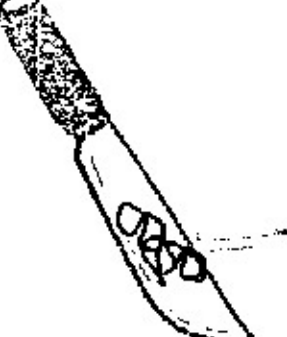

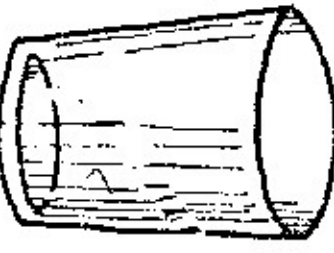
C 12

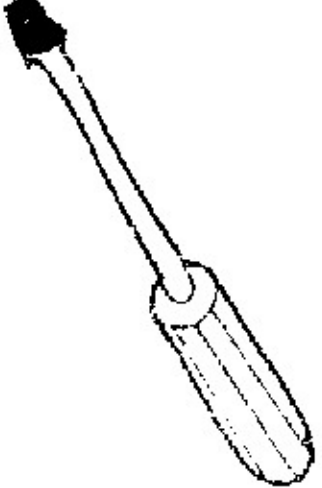

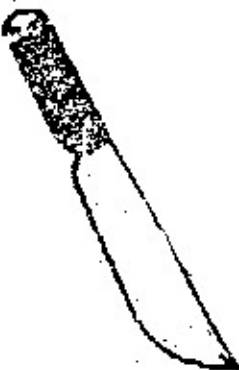
ให้บุตรอ่านคำข้างหน้าให้เด็กฟัง และให้เด็กขีด ✕ ทับ ภาพที่เกี่ยวข้องกับคำที่อ่าน

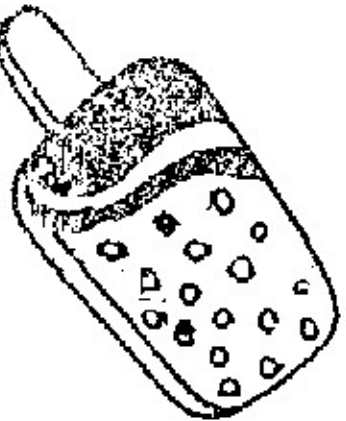
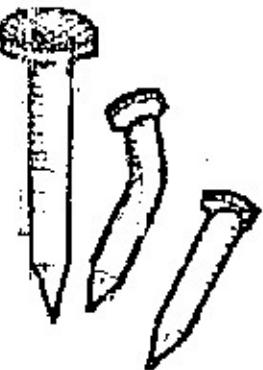
1 ปลา				
2 เสื้อ				
3 ถ้วย				
4 เลื่อย				
5 แม่พิมพ์				

၄

တစ်ခု

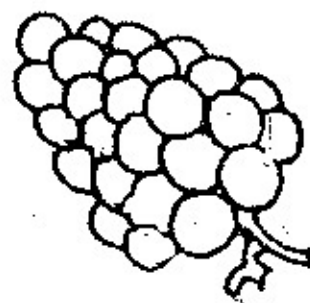
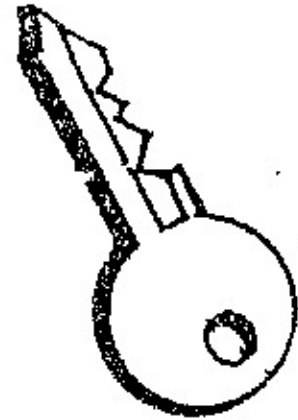
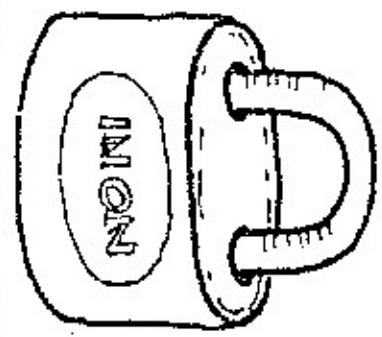

၅

ယာဉ်

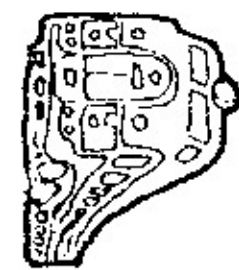
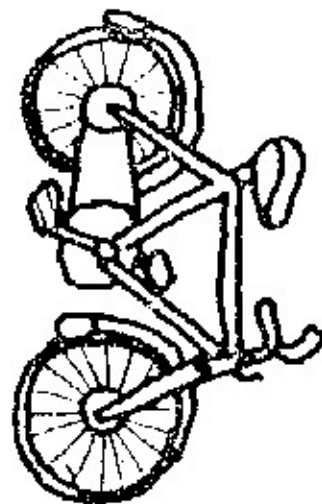
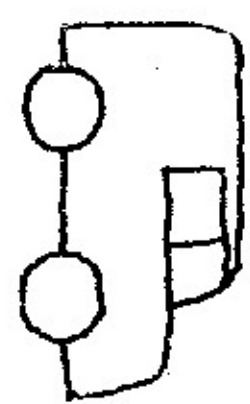
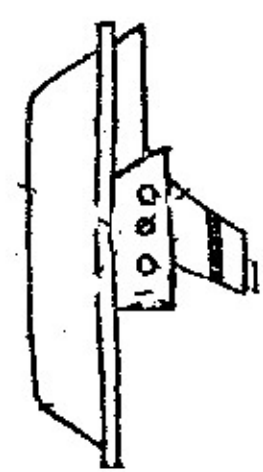

၆

အိမ်

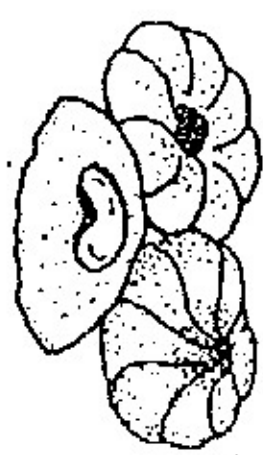
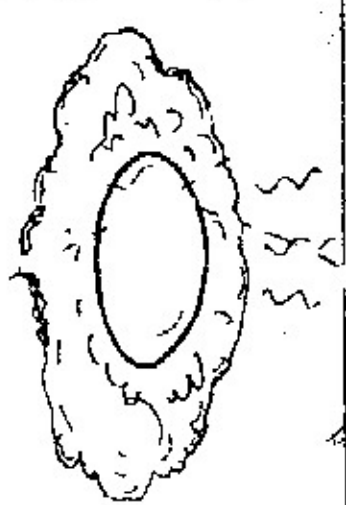

၇

ပဲခူး

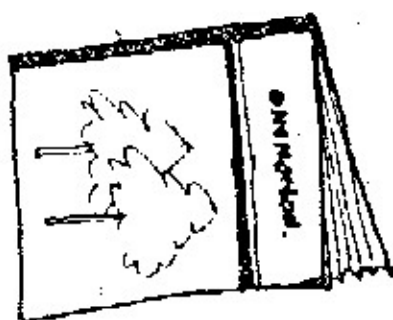
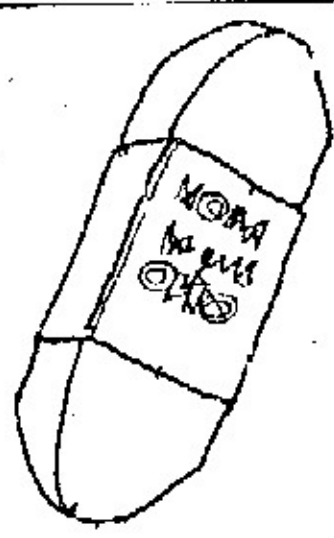
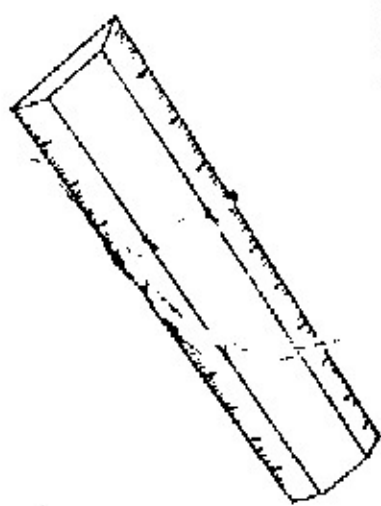
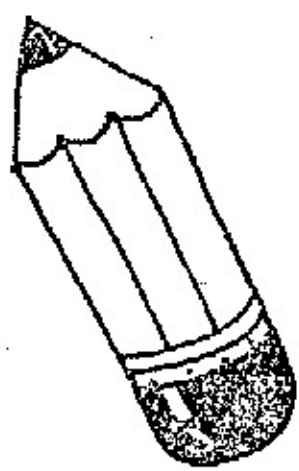

၈

ပဲခူး

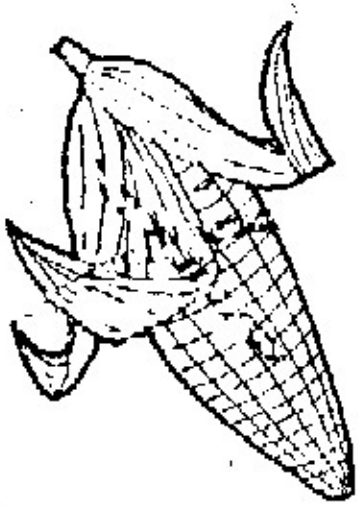

11.

မုန့်

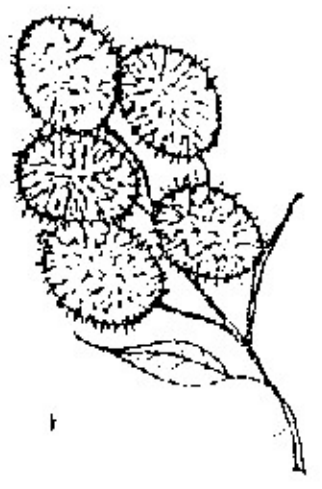

12.

ခါး



13.

ခွေ

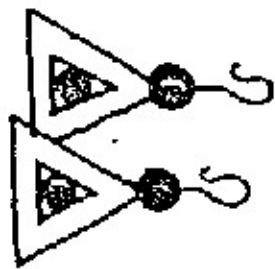
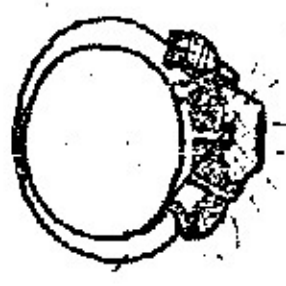

14.

ကလံခွေ

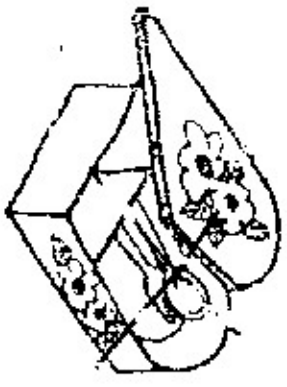
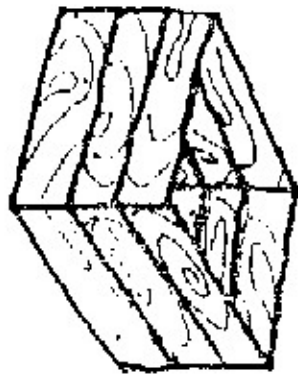
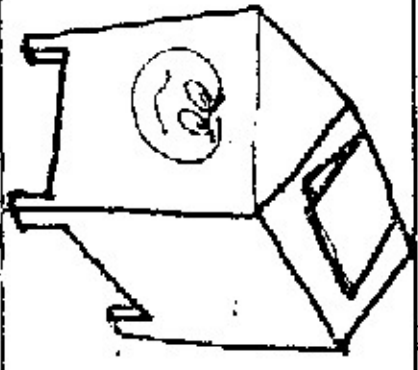
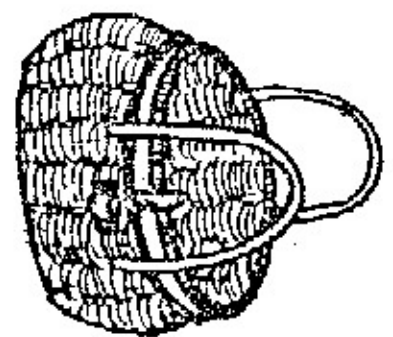

15.

မုန့်

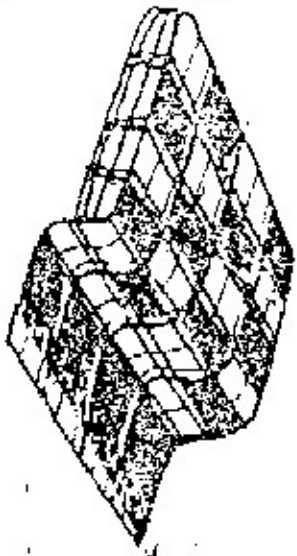
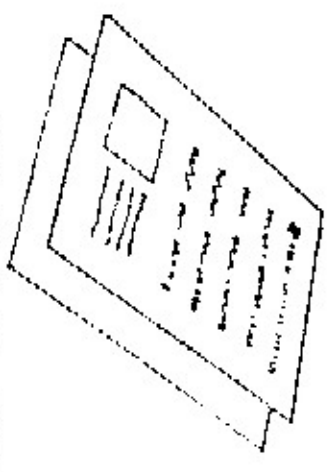
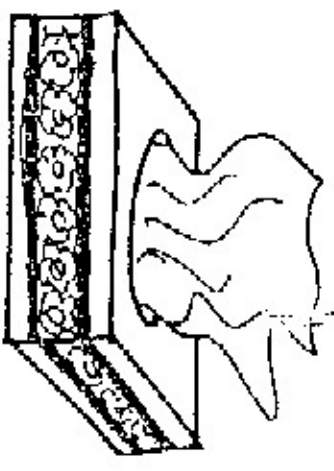
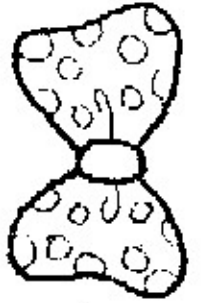

កម្រាល

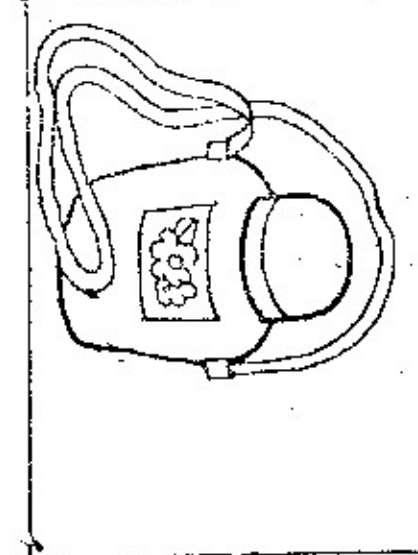
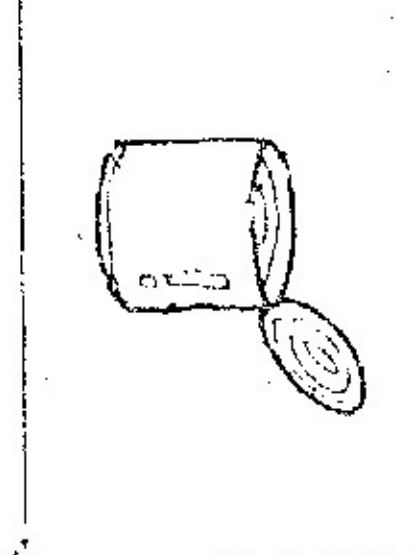
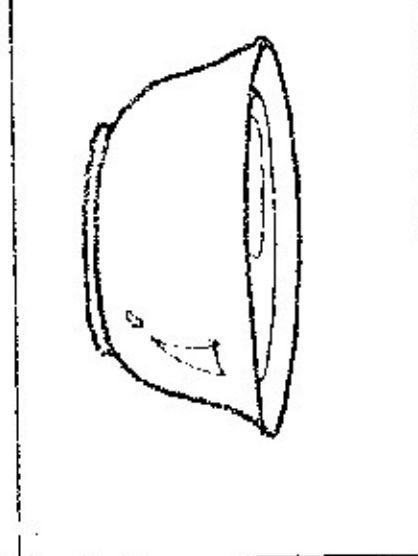
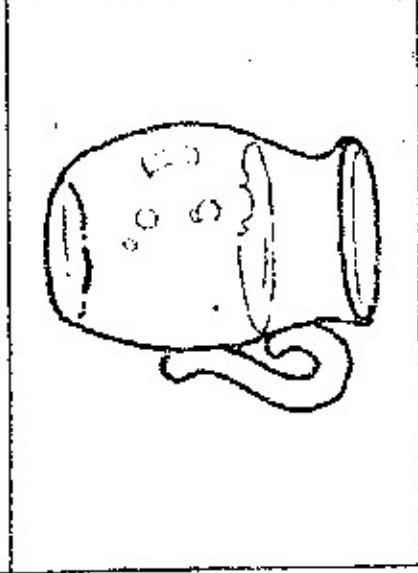

ក្រែង

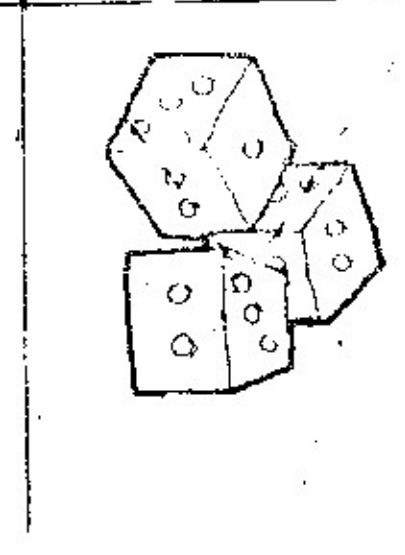
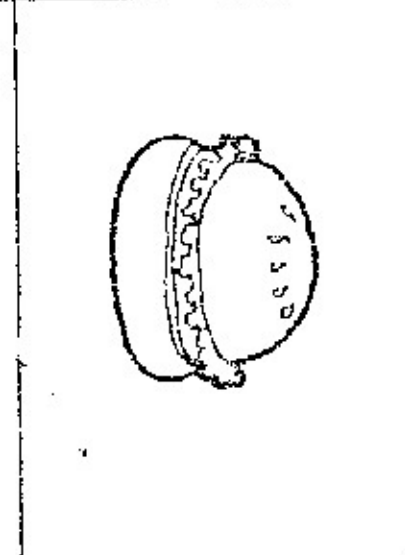
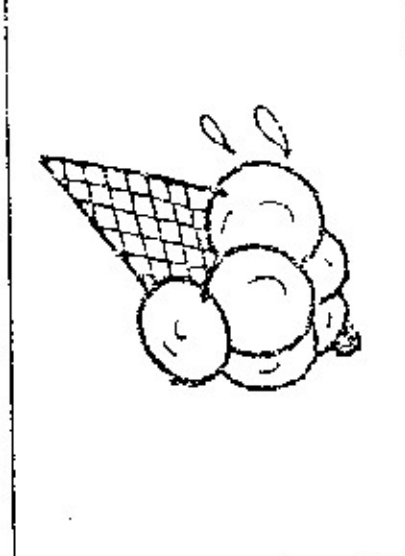
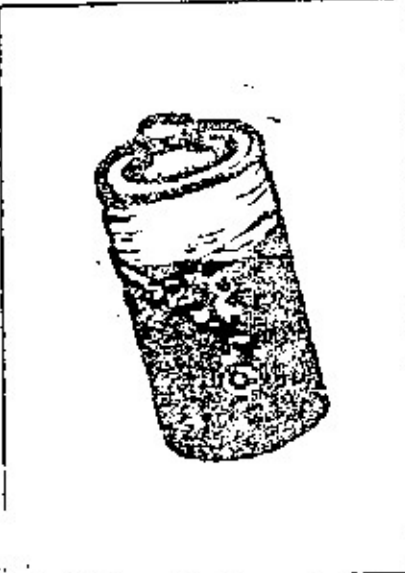

ស្រោង

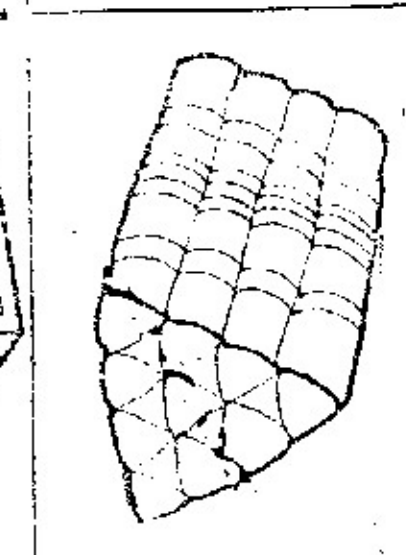
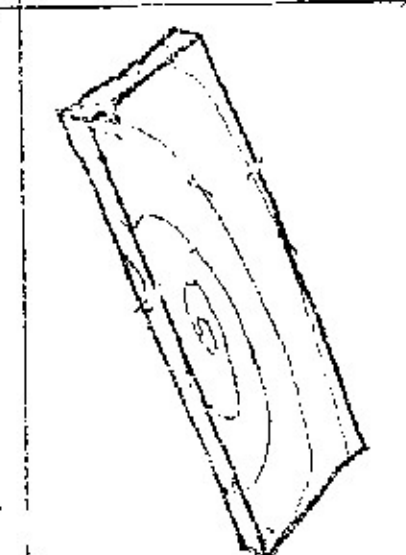
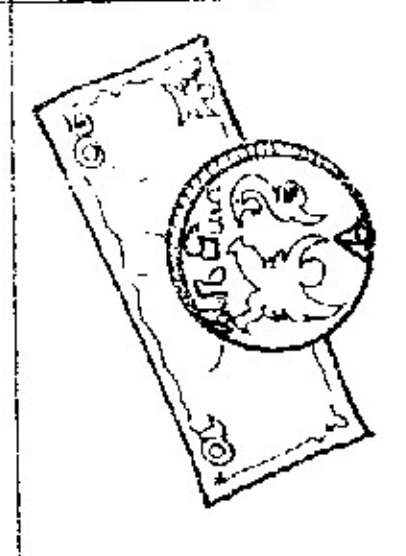
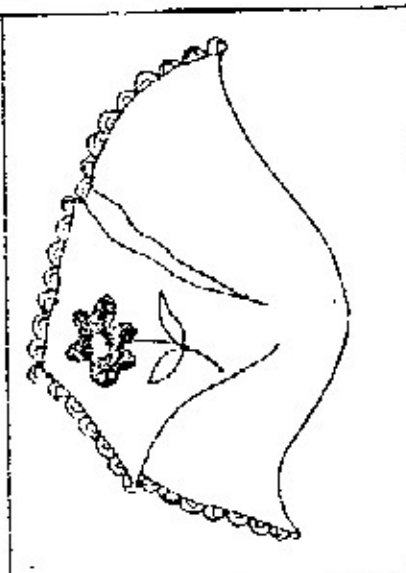

ប្រារ

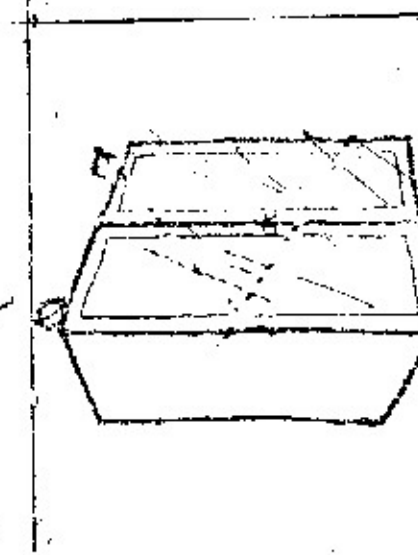
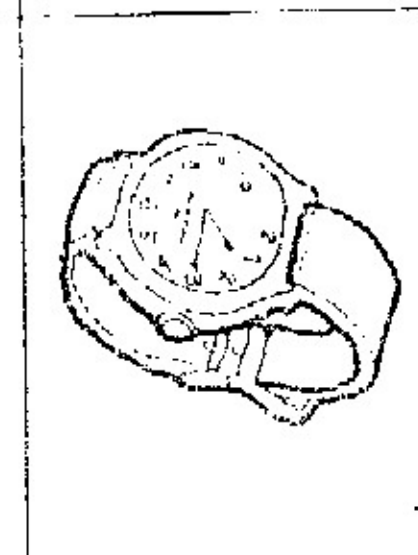
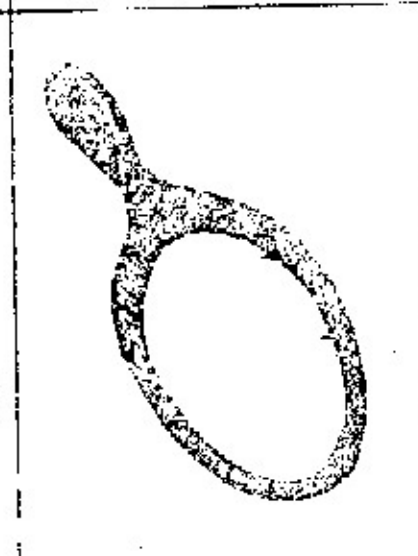
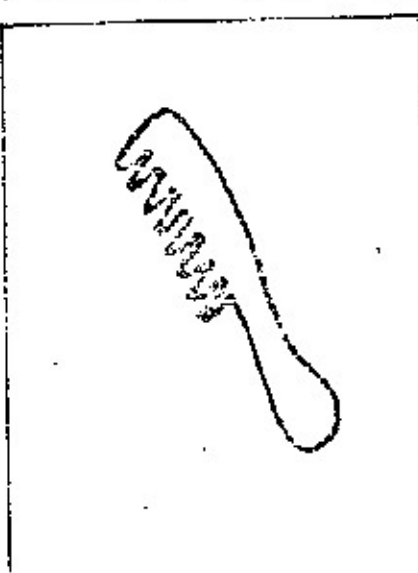

ក្បាល

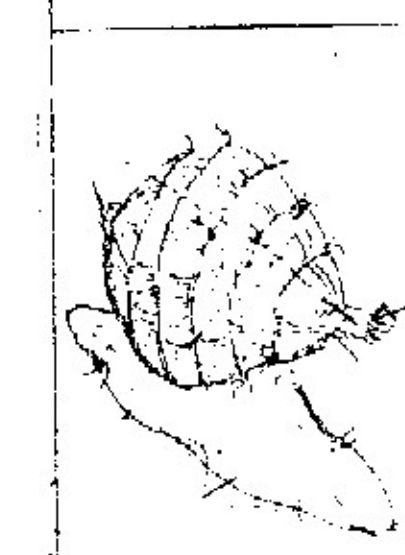
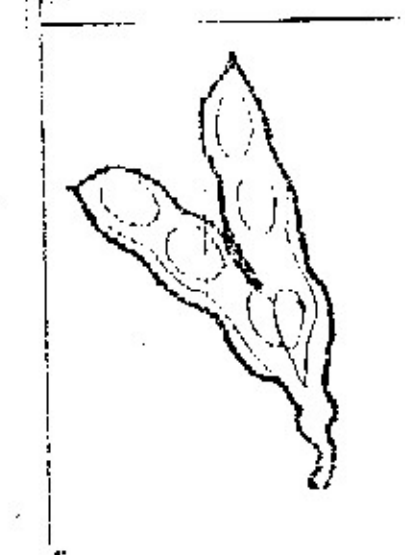
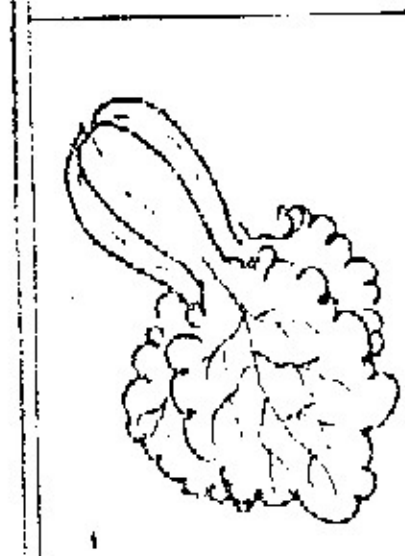
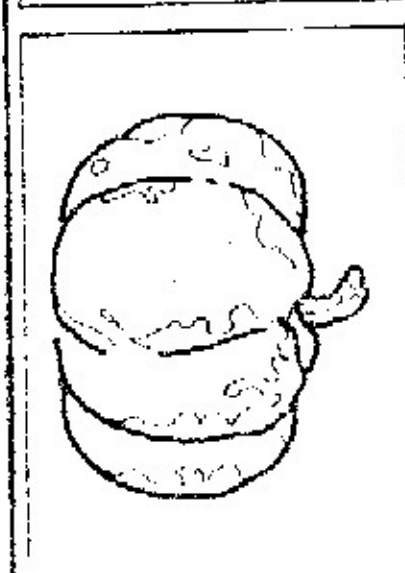

မျှော်

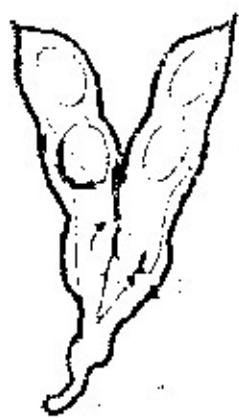
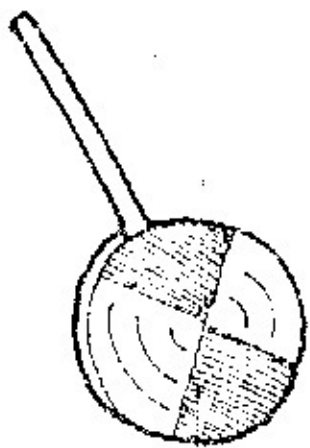
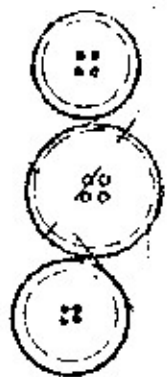

ပျံ

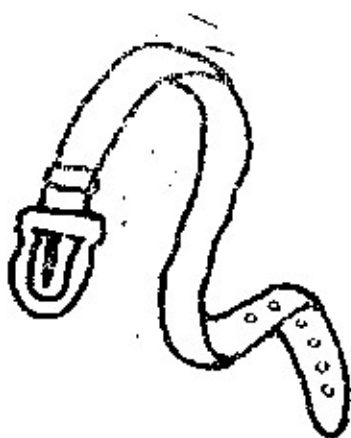

မုန့်

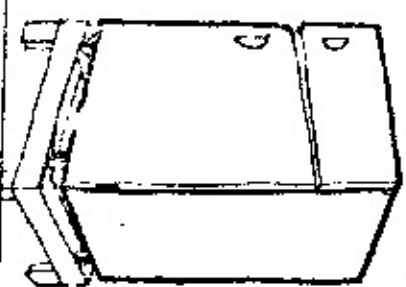
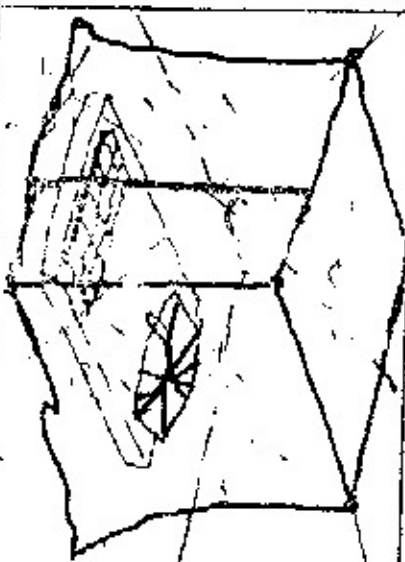
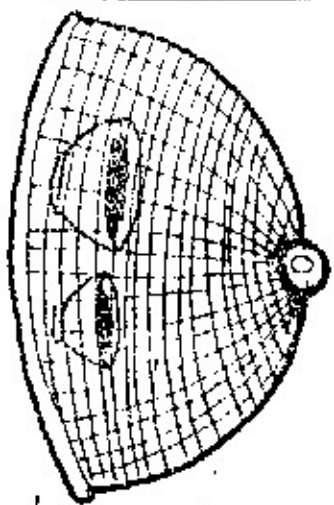

မြေခွက်

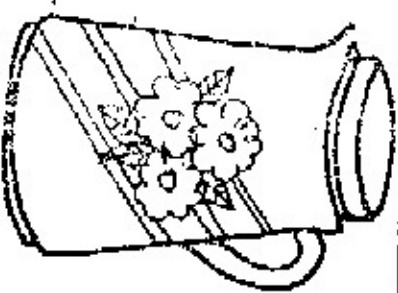
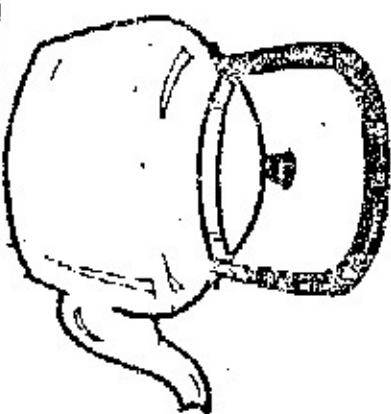

ဇုန်

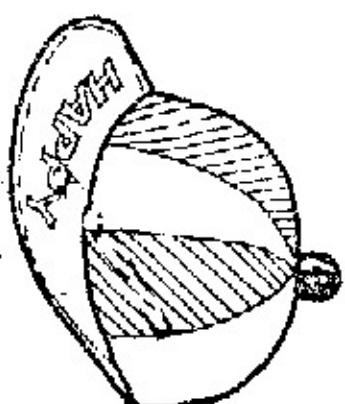
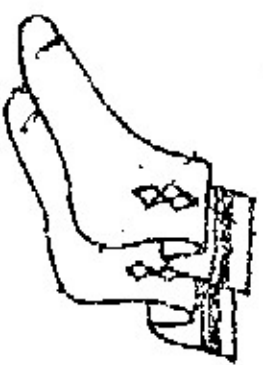
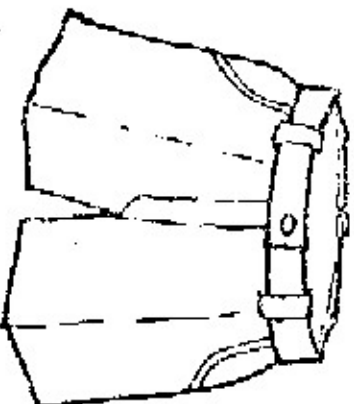
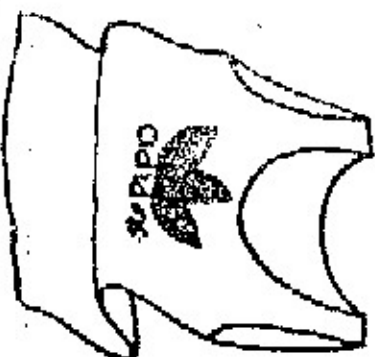

ຫີນ

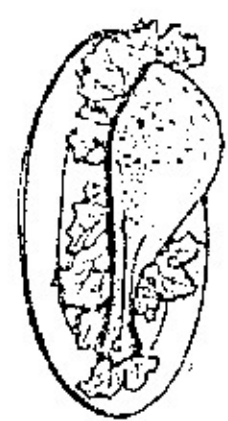
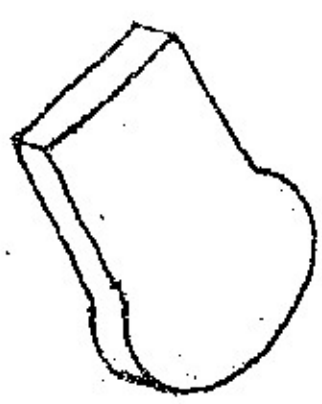
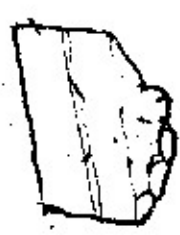
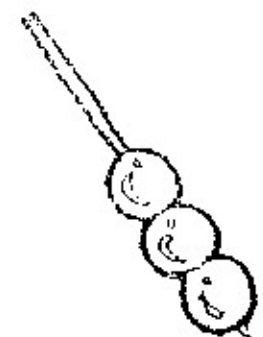

ກະບອກ

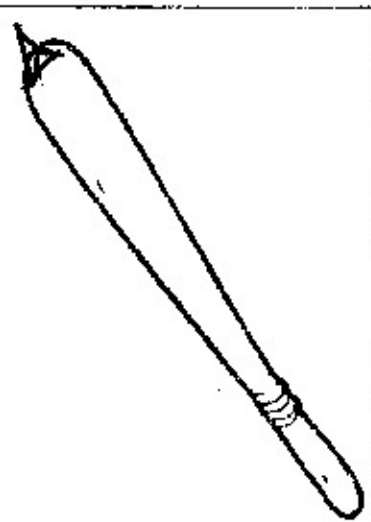
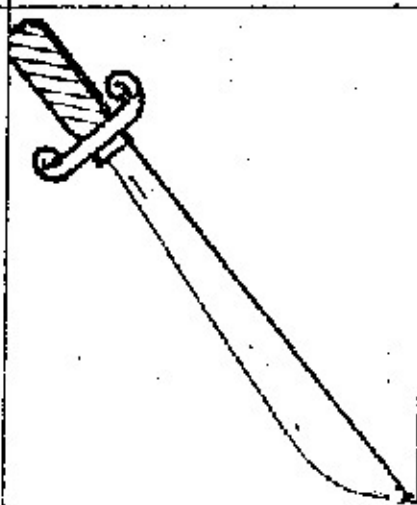
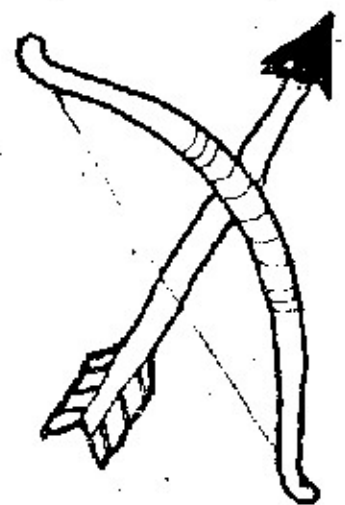
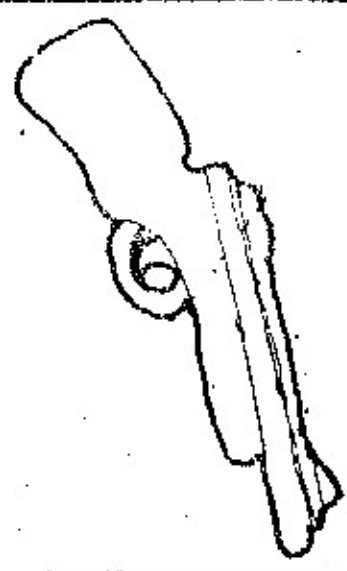

ເຮົາ

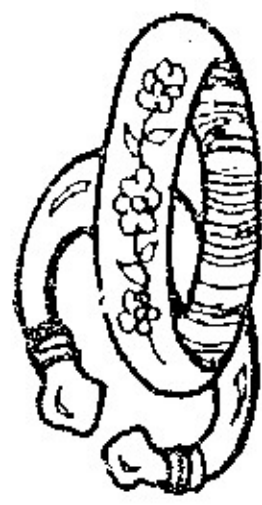
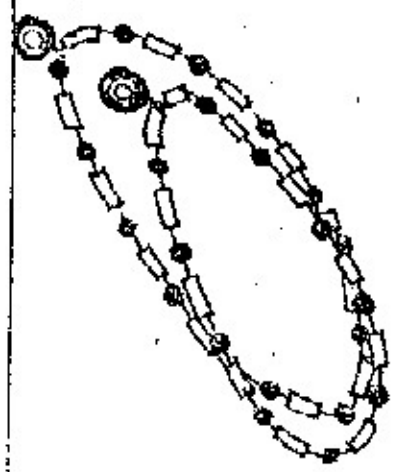
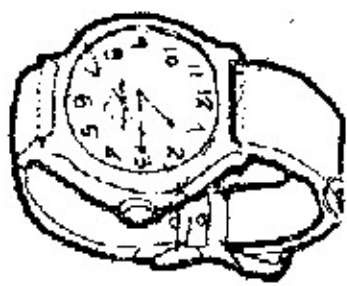

ໂສ້ນ

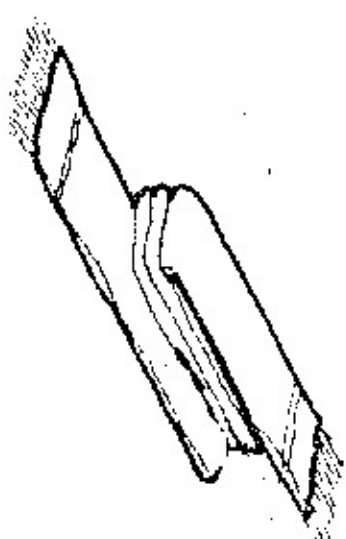
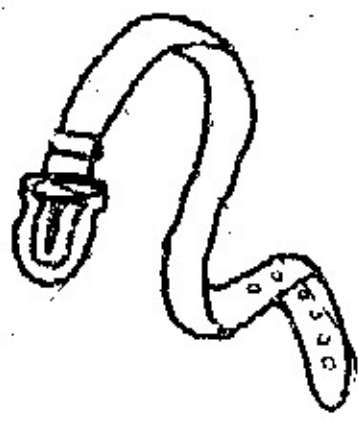
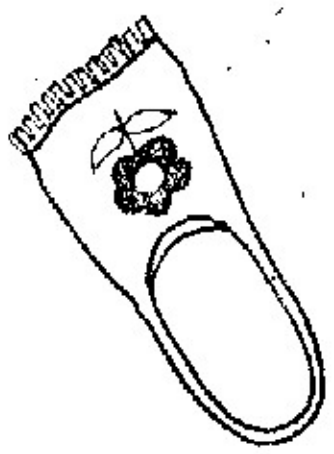
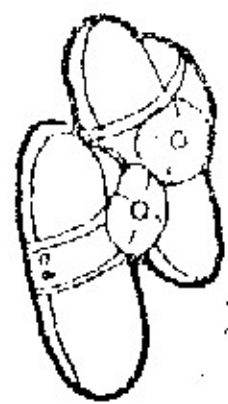

ໂປດ

